

BRAKE PAD & BRAKE SHOE CATALOG

CONTENTS

Structure of brake system and parts1

Manual

Raw material and application2

Required performance of disc pad3

Mechanism of squeak generation and countermeasures4

Squeak generation pattern and countermeasures5

Vibration control measure6~8

About wear at early stage9

Structure of brake system and parts

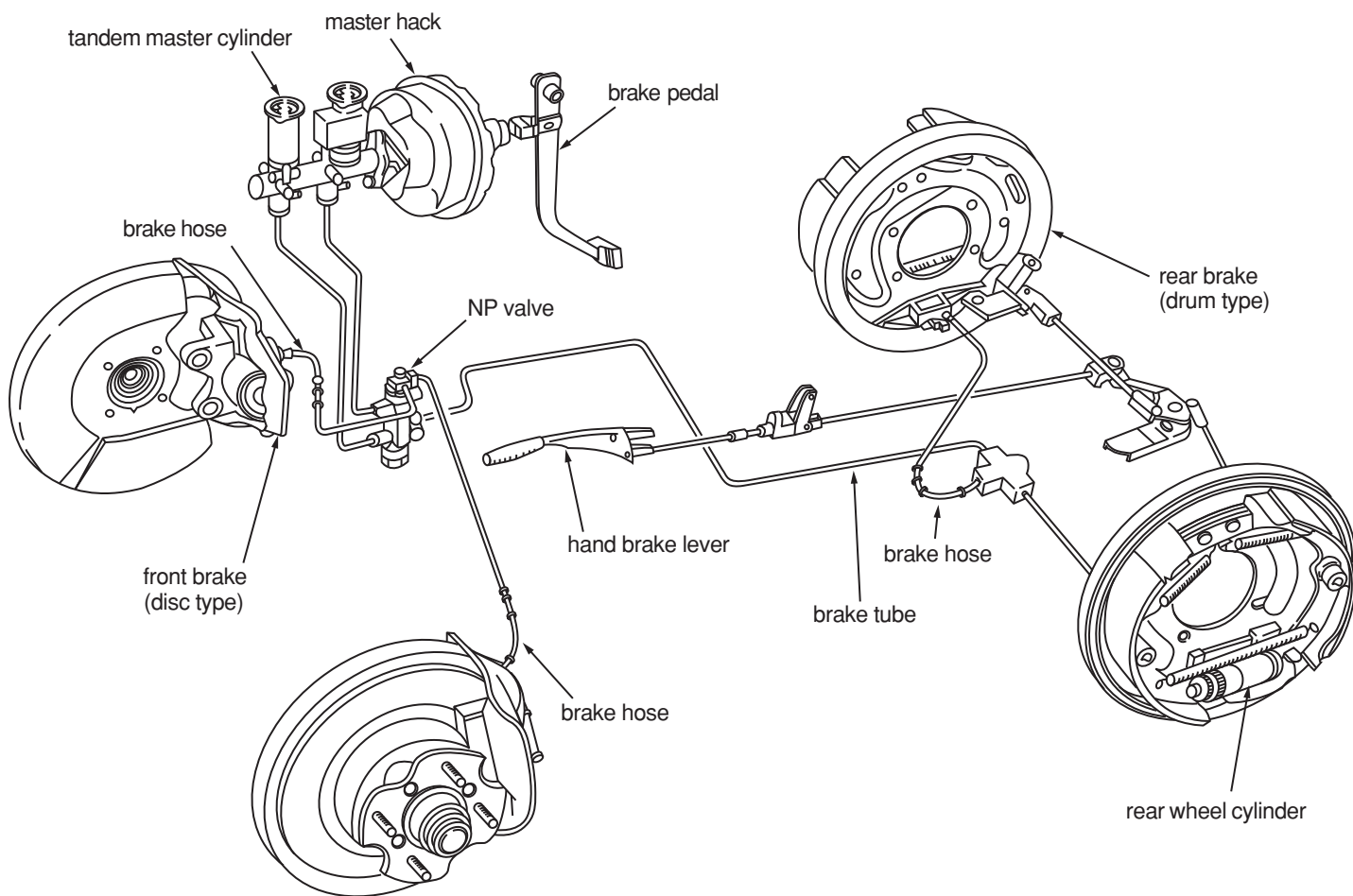

Raw material and application

(Structure of pad is similar to reinforced concrete)

Concrete	Raw material for pad	Application
Reinforcing bar	Aramid fiber (Chemical fiber) Steel and non-ferrous metal fiber Asbestos	Used for base material Absorbing vibrations, and providing high strength and high friction
Cement	Resin (Thermoset resin)	Used for binder
Small stones	Brass powder, copper powder, etc.,	Local heating prevented by thermal conductive property
Gravel	Graphite, cashew dust, etc.,	Stability of wear-resistant performance and friction coefficient improved

Required performance of disc pad

No	Item	Performance	Description
1	Stability	•Braking level	Friction coefficient (μ) should be appropriate and stable. $\mu = \text{Braking force} / \text{Pressing force}$
		•Braking effect	○Speed spread ⇒The smaller the variation of friction coefficient (μ) due to velocity, the better. ○Water recovery ⇒Friction coefficient (μ) loss due to water leakage should be recovered as the number of brakings increases. JASO requires 15 brakings for full recovery ○Morning sickness (Morning effect) ⇒A phenomenon where the friction coefficient (μ) increases as affected by moisture. The smaller the number generated the better. It should be recovered soon even if the phenomenon is generated.
		•Fading and recovery	○Fading ⇒Temperature rises due to friction heat to lower friction coefficient (μ). This phenomenon is called fading phenomenon. The smaller the loss of braking force, the better. ○Recovery ⇒To be rapidly recovered to the original friction coefficient (μ) level
		•Strength	No crack generation during application is allowable
2	Durability	•Wear	Wear should be stable and an amount of wear should be small.
		•Face attack	The following phenomena should be rarely generated: ☆Scoring = Generation of scratches on friction surface ☆Heat crack = Cracks in friction surface ☆Heat spot = Local color change and spots on friction surface
3	Discomfort	•Squeak	Has no relation to performance, but undesirable feeling may be generated ☆Frequently generated in the midst of braking ☆Easily generated after excessive repetition of braking (thermal hysteresis) ☆Easily generated due to atmospheric temperature ☆More easily generated after long use rather than just after starting new one
		•Judder	Means vibration. No chattering allowable.
		•Feeling	Braking should be performed smoothly.

Mechanism of squeak generation and countermeasures

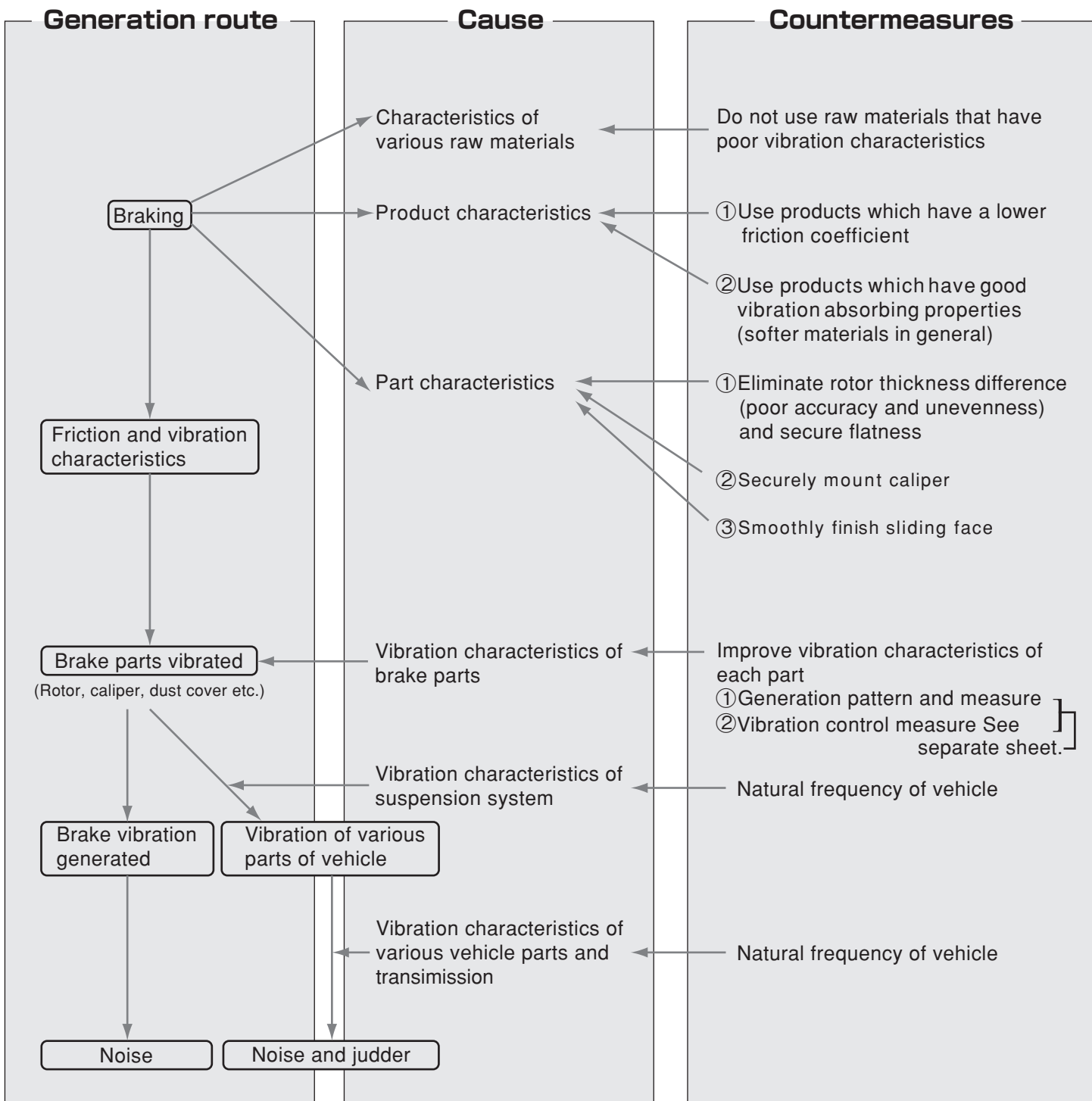

General classification of brake squeak

Item \ Frequency	400 - 700Hz	1 - 6kHz	7 - 11kHz
Name of squeak	Groan	Squeal	Squeak
Tone	Goo	Quee	Chee
Main vibration source	Resonance of drum and/or caliper	Resonance of shoe and/or disc	Elastic vibration of lining and/or pad

① Squeak generation pattern and countermeasures

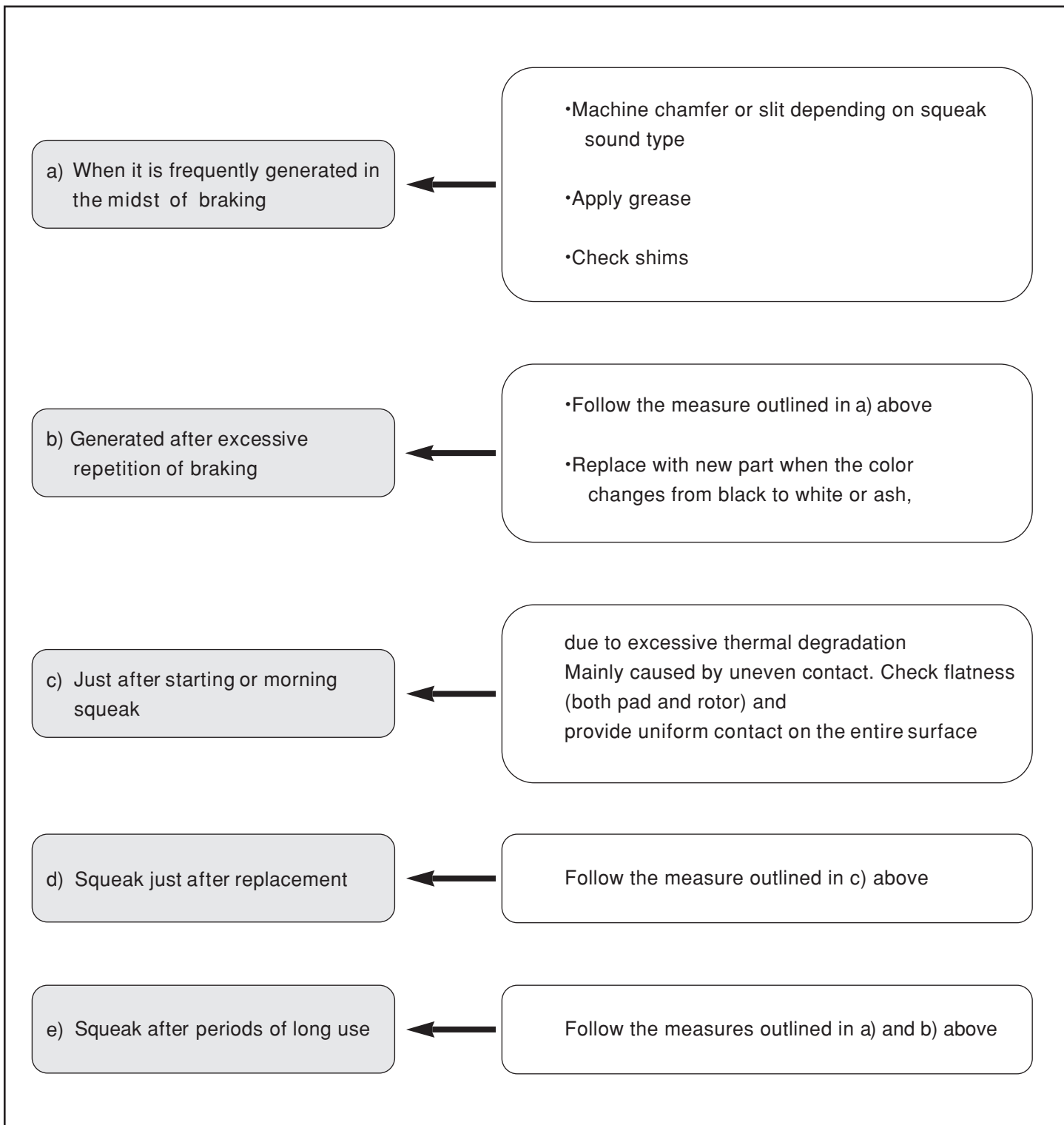

② Vibration control measure

1. Partial machining

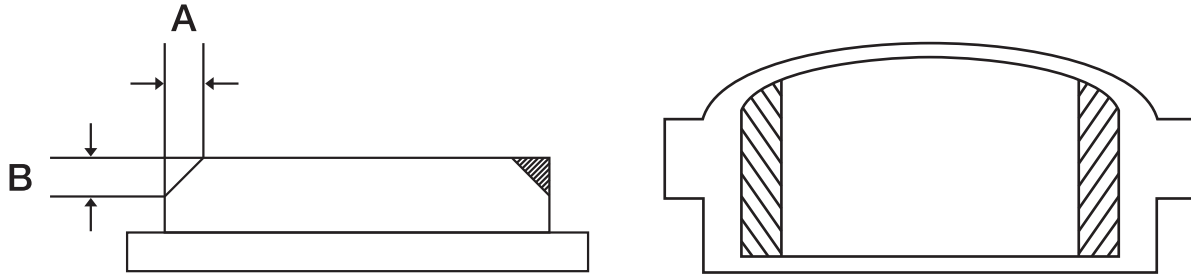

1) Chamfer cut for edge: Significant effect on "quee" and "chee" sound.

- Allowable machining dimension
- ① Maximum allowable area to be removed should be no more than 20% of friction surface.
 - ② Maximum value of dimension A should be 15 mm.
 - ③ Maximum value of dimension B should be 8mm.

2) Slit machining (one or two slits may be machined)

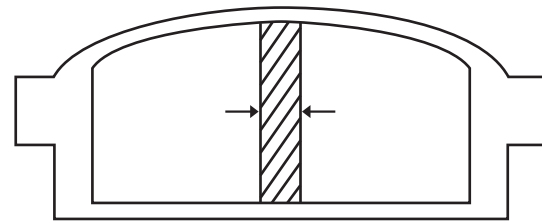
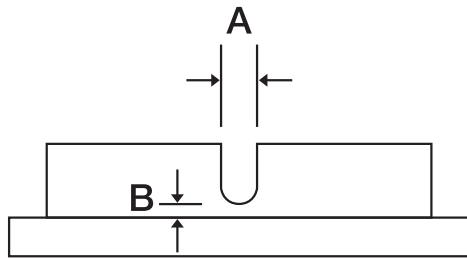

Machine slit at a right angle in a longitudinal direction
→ Significant effect on "quee" and "goo" sound.

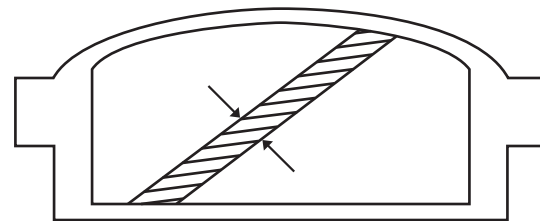
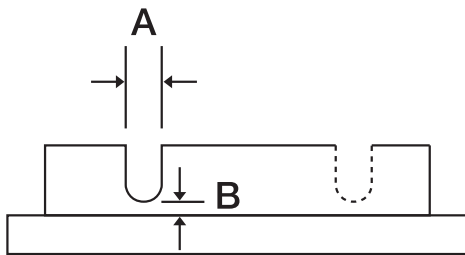

Machine slit diagonally in a longitudinal direction.
→ Significant effect on "goo" sound.

- Allowable machining dimension
- ① Machining width A should be 2.5 ± 0.5 mm
 - ② Remaining depth B of friction material after machining should be 3.0 ± 0.5 mm from the plate surface.

※ Note : Minimize machining dimension. (To secure friction force.)

3) Correct the condition of contact face (uneven contact, local contact or scratches on rotor surface).

① Machine both friction material and rotor to make them flat.

② Replace with the genuine product.

※ Warning: The friction trace of the rotor surface may not always match with the pad after replacement.

2. Shim installation

Insert a special shim (genuine product reference) to the back of plate. Single and double shims are available. As older shims that show thermal degradation may have no benefit, they should be replaced.

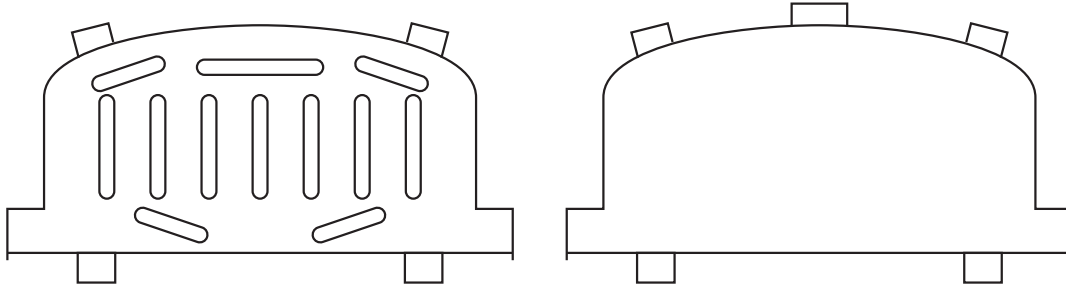

3. Grease application

1) Type of grease: (Mainly molybdenum grease) Various kinds of heat-resistant grease are available commercially.

2) Area of grease application

① Contact face between outer shim and pad

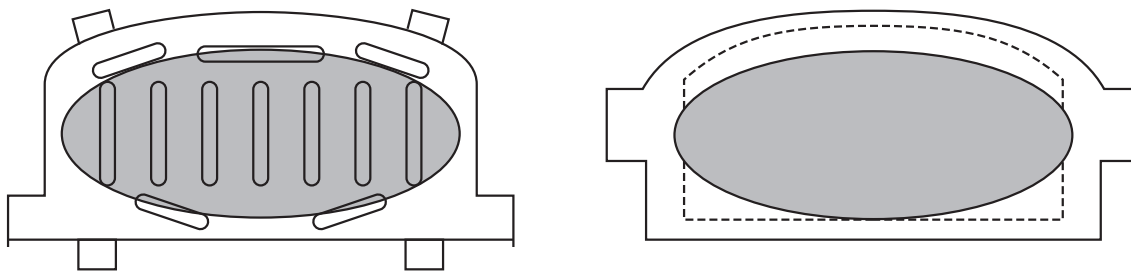

※ Note ① Do not apply grease on friction material or rotor surface (It may lower the friction force).

※ Note ② Correctly install not only shims but also small genuine parts when attaching pad.

3) Amount of application: Grease should not be squeezed out from the attaching area.
(Reference: about 3 - 4 g/set)

4) Application interval: Apply when replacing parts and recognizing squeak.

5) Application method: Use spray system or manually apply.(tube, canned, plastic bag)

② Contact face between piston end surface and inner pad.

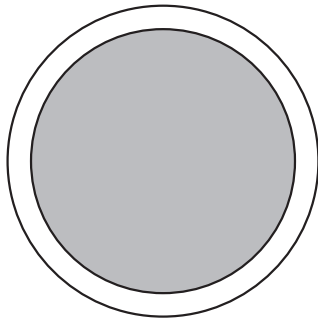

Piston end surface

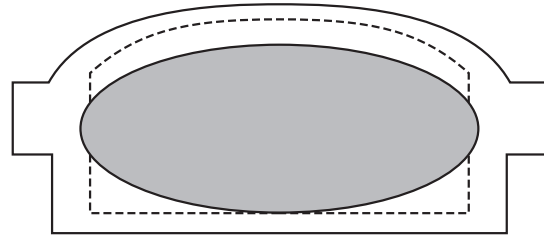

③ Contact face between caliper body and outer shim.

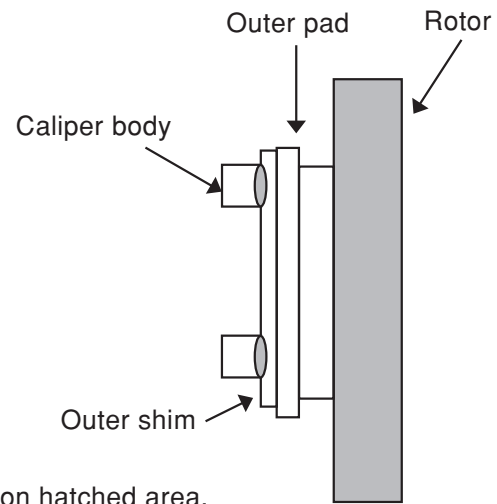
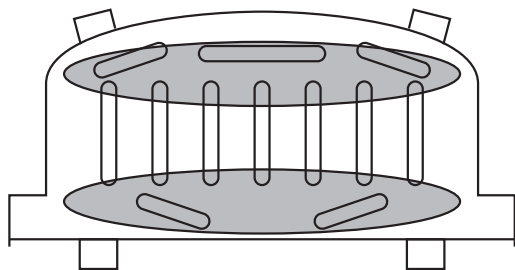

※ Apply on hatched area.

④ Contact face between caliper bracket and pad

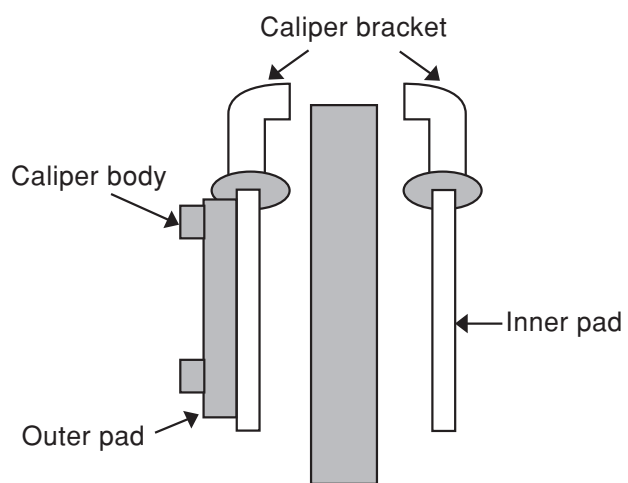

About wear at early stage

Disc brake life is shorter than that of drum brake as the structure of disc brakes limits the area of friction material.

Disc brake are widely used, especially in compact cars, for the following reasons:

- Stable braking effect
- Less fade phenomenon because of effective cooling
- Easy pad replacement

Wear of disc pad at an early stage is mainly caused by exposure of the friction material surface to heat. The relation between the temperature of friction material and the amount of wear shown in the following graph tells that the amount of wear rapidly increases when the temperature exceeds the specific point T1.

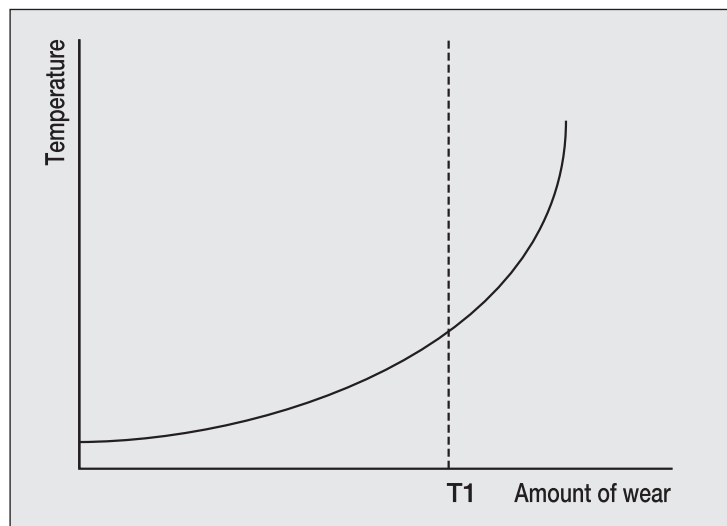

Generally T1 is 200 - 250°C for asbestos, and 250 - 300°C for non-asbestos.

Cause of heat generation in disc pad : Braking at high speed and frequent braking on slopes.

Kinetic energy (E) Kinetic energy of the car is proportional to the square of its speed.

$$E = \frac{1}{2}MV^2 \quad M = \text{Mass of car} \quad V = \text{Velocity of car}$$

☆ **The higher the speed, the larger the amount of heat generated, and the friction material will be strongly affected by the heat.**

Cause of wear at early stage ⇒ ⇒ ⇒ - Lining temperature rises extraordinarily due to severe operating conditions.

- Inferior piston seal
- Inferior return motion due to cylinder galling

DISC BRAKE PADS & BRAKE SHOE ASSY

New Products

***CAR MODEL
CROSS REFERENCE***

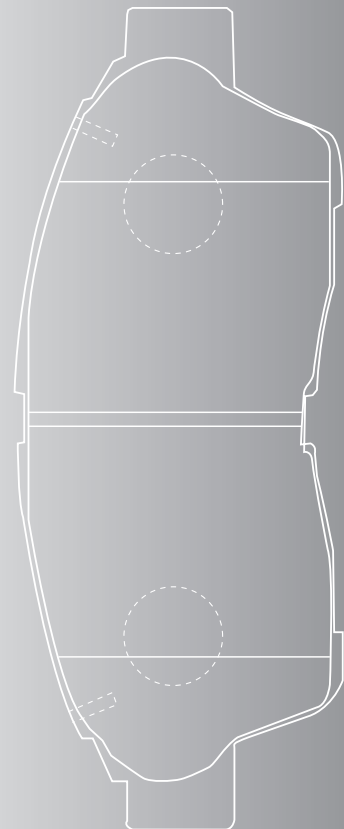

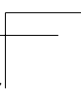
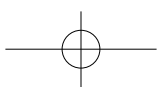
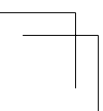
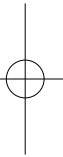
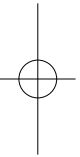
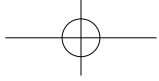
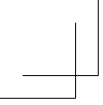

New Products

CAR MODEL

Model 車種形式	Year 年式	Front フロント		Rear リア		Parking パーキング
		Pad パッド	Shoe シュー	Pad パッド	Shoe シュー	Shoe シュー
NISSAN						
120Y, 140Y, 150Y, ALMERA, SUNNY, SENTRA						
N17K	11.09 ~ 11.12	HN-949				FN-1286
	11.12 ~ 15.06	HN-949				FN-1286 or NA
N17G, N17KK, N17GG, N17MM	12.05 ~ 16.07	HN-949 or NA				FN-1286
ALMERA						
N16	00.01 ~ 06.06	HN-950		HN-971 or N/A		FN-1247 or N/A
N16E	00.01 ~ 06.06	HN-950		HN-971 or N/A		FN-1247 or N/A
B10RS	06.01 ~ 13.03	HN-435				FN-1279
ALTIMA						
	13 ~	HN-975				
ARMADA USA						
5600	04.01 ~ 09.12	HN-961		HN-920		
	07.03 ~ 09.12			HN-920		
ATLAS NT450						
3000 FBA2W, FEA2W, FEB2W, FDA2W, FDA4W, FGA2W	13. 1 ~	HN-574		HN-573		FN-6680
FBA3W, 5W, 6W, FEA5W, 8W, FEB5W, 8W, 9W, FEA5X, 7X	13. 1 ~	HN-575		HN-575		FN-6680
FGB7W 2t,3t,4WD HIGH FLOOR	13. 1 ~	HN-575	FN-6653	HN-575	FN-6722	FN-6680
AH44	14.01 ~	HN-575		HN-575		FN-6680
BLUE BIRD						
P811, PJ811, 910 series	78. 7 ~ 83. 1					FN-1148
BLUEBIRD SYLPHY						
G11Z	06.08 ~ 09.03					FN-1299
CARAVAN						
VTE24, VTGE24, CTGE24, DTGE24, FTGE24	92.10 ~ 99.06	HN-320				
VRE24, VRGE24, CRGE24, VRMGE24	92.10 ~ 97.05	HN-320				
CRMGE24	90.10 ~ 96.09	HN-320				
E20, E21 series	75.11 ~ 80. 7					FN-1105
CARAVAN・HOMY						
E20, E23 series	78. 3 ~ 83. 4		FN-1151			
E23 series	80. 8 ~ 82. 5					FN-1158
E24 series	86. 9 ~ 01. 3					FN-1171
CUBE						
Z12	09.08 ~ 10.06	HN-474		HN-466		FN-1299
Z12	10.06 ~	HN-474		HN-565		FN-1299
DATSUN TRUCK						
GD21, FLD21, D21	85. 9 ~					FN-1175
320, 520, 521, 620	61. 8 ~ 79.10					FN-1105
720 series	79. 8 ~ 83. 3		FN-1151			
	79.10 ~ 82. 1					FN-1158

New Products

CAR MODEL

Model 車種形式	Year 年式	Front フロント		Rear リア		Parking パーキング
		Pad パッド	Shoe シュー	Pad パッド	Shoe シュー	Shoe シュー
DATSUN TRUCK						
D21 series 4WD	85. 8 ~ 96.12					FN-1171
DAYZ						
660 B21W	13. 6 ~	HN-570				FN-6726
TURBO	13. 6 ~	HN-566				FN-6726
DAYZ ROOX						
660 B21A 2WD	14. 2 ~	HN-570				
4WD	14. 2 ~	HN-566				
DUARIS						
2000 KJ10, KNJ10	09. 9 ~ 10. 6	HN-546		HN-466		
	10. 6 ~ 13.12	HN-546		HN-565		
e-NV200						
EV ME0, VME0	14.10 ~	HN-565				
FRONTIER						
2400 D22	02.01 ~ 04.06	HN-701				
3300 D22	02.01 ~ 04.06	HN-701				
FUGA						
3500 HY51 HYBRID	10.11 ~	HN-444		HN-565		
JUKE						
F15	10.07 ~ 11.08	HN-474		HN-565		FN-1299
F15E	10.07 ~	HN-474		HN-565		FN-1299 or N/A
LAFESTA・HIGHWAYSTAR						
2000 CWEFWN, CWEAW	11. 6 ~	HN-507		HN-578		
CWFFWN	13.12 ~	HN-507		HN-578		
LAUREL						
C230, C31series	77. 1 ~ 84.10					FN-1148
LEAF						
	14 ~ 16	HN-975				
ZE0	10.12 ~	HN-517		HN-565		FN-1299
AZE0 ~100000	12.11 ~ 13.12	HN-517		HN-565		
100001~	13.12 ~			HN-565		
MARCH						
K13T	11.03 ~	HN-555				FN-1280
K13N	12.11 ~	HN-555				FN-1280
MAXIMA						
3000 E-PJ30 (EJ30)	91.08 ~ 94.08	HN-954				

New Products

CAR MODEL

Model 車種形式	Year 年式	Front フロント		Rear リア		Parking パーキング
		Pad パッド	Shoe シュー	Pad パッド	Shoe シュー	Shoe シュー
MAXIMA QX						
2500 A32	94.10 ~ 00.08	HN-954				
3000 A32	94.10 ~ 00.05	HN-954				
3500 L31	04.01 ~ 07.01	HN-958				
MICRA						
K13K	10.05 ~ 15.10	HN-949 or NA			FN-1286 or NA	
K13KK	15.10 ~	HN-949			FN-1286	
MOCO						
660 MG33S	13. 7 ~				FN-9999	
MURANO						
2500 CBA-TZ50	04.09 ~ 08.09	HN-958				
3500 PZ50, PNZ50/PZ50	04.09 ~ 08.09	HN-958				
CBA-PNZ51	08.09 ~	HN-958				
NAVARA						
2400 D22	02.01 ~ 05.12	HN-701			FN-1189	
2500 D40	06.10 ~ 09.11	HN-962				
NOTE						
1200 E12	12. 9 ~	HN-555		HN-581		
NE12 4WD	12. 9 ~	HN-555		HN-581 or FN-1264		
E12E	13.08 ~	HN-949			FN-1286	
NOTE(EURO)						
1400 E11 MPV	06.01 ~	HN-959			FN-1225	
1500 E11 MPV	06.01 ~	HN-959				
1600 E11 MPV	06.01 ~	HN-959				
NP300						
D22SS 2WD	10.08 ~	HN-137 or N/A			FN-1174	
4WD	10.08 ~	HN-701			FN-1189	
LCD22S KA20	08.01 ~	HN-137			FN-1174	
KA24	08.01 ~	HN-137 or HN-701			FN-1189	
YD25	08.01 ~	HN-137 or N/A			FN-1174 or FN-1189	
D22X KA24DE, YD25DDT1	08.03 ~	HN-137, HN-701 or N/A			FN-1174, FN-1189 or N/A	
D22SS TD27	09.10 ~	HN-105, HN-137 or N/A			FN-1174 or N/A	
KA24, YD25, QD32, ZD30	09.10 ~	HN-137, HN-701 or N/A			FN-1174 FN-1189 or N/A	
NT100 CLIPPER						
660 U71T, U72T	12. 1 ~ 13.12	HN-437			FN-6729	
DR64T	13.12 ~	HN-566			FN-9966	
NV VANETTE						
1600 DBA-M20, DBA-VM20	09.05 ~	HN-960			FN-1276	

New Products

CAR MODEL

Model 車種形式	Year 年式	Front フロント		Rear リア		Parking パーキング
		Pad パッド	Shoe シュー	Pad パッド	Shoe シュー	Shoe シュー
NV100 CLIPPER						
660 U71V, U72V	12. 1 ~ 13.12	HN-437			FN-6729	
DR64V, DR64W	13.12 ~	HN-566			FN-9966	
NV100 CLIPPER Rio						
660 DR64W	13.12 ~ 15. 2	HN-566			FN-9973	
DR17W	15. 2 ~	HN-566				
NV350 CARAVAN						
2000 VR2E26	12. 6 ~	HN-475				
2500 VW2E26, VW6E26, VW8E26, KS2E26, KS4E26	12. 6 ~	HN-475				
PALSAR, TIIDA						
C12T	13.01 ~	HN-474		HN-565		FN-1299
PATHFINDER						
	05 ~ 10					FN-1902
2500 R50	97.01 ~ 2.12	HN-701			FN-1189	
R51	05.06 ~ 09.11	HN-962				
3000 R51	10.08 ~	HN-962				
4000 R51	05.05 ~ 09.11	HN-962				
PATROL						
2800 Y61	97.06 ~	HN-132		HN-955		
4800 Y61	00.03 ~	HN-413		HN-955		
5600 Y62	12.11 ~	HN-973 or NA				
	10.03 ~			HN-979 or NA		
PICK UP						
2400 D22	02.01 ~ 05.12	HN-701			FN-1189	
2500 D22	02.03 ~ 05.08	HN-701			FN-1189	
PRIMERA/PRIMERA ESTATE/PRIMERA WAGON						
1600 WP11E	98.02 ~ 01.12	HN-950		HN-971	FN-1221	
P11E, WP11	98.04 ~ 02.12	HN-950		HN-971	FN-1221	
1800 P11E, WP11E	99.06 ~ 01.12	HN-950		HN-971	FN-1221	
2000 WP11	98.02 ~ 02.01	HN-950		HN-971	FN-1221	
P11E	98.04 ~ 01.12	HN-950		HN-971	FN-1221	
WP11E	98.02 ~ 01.12	HN-950		HN-971	FN-1221	
QASHQAI, QASHQAI+2						
J10E	06.12 ~	HN-546 or N/A		HN-466		FN-1299
JJ10E	08.08 ~	HN-444 or HN-546		HN-466		FN-1299
ROGUE						
S35	07.09 ~	HN-546		HN-466		FN-1299
	08.06 ~	HN-546		HN-466		FN-1299

New Products

CAR MODEL

Model 車種形式	Year 年式	Front フロント		Rear リア		Parking パーキング
		Pad パッド	Shoe シュー	Pad パッド	Shoe シュー	Shoe シュー
SENTRA						
B16X, QR25DE	06.10 ~ 10.08	HN-546		HN-466		FN-1299
B17T	12.07 ~	HN-505		HN-565		FN-1299
B17U	12.09 ~	HN-474		HN-565 or	FN-1294	FN-1299
B15U, QG18DE	00.01 ~ 01.01	HN-176			FN-1247	
SERENA						
C23M	94.10 ~ 01.09	HN-922				
C26N	12.12 ~	HN-517		HN-565		FN-1299
2000 C25, NC25 HIGHWAY STAR	10. 6 ~ 10.11	HN-517		HN-466		
CC25, CNC25	10. 6 ~ 10.11	HN-517		HN-565		
C26, NC26, FNC26	10.11 ~	HN-517		HN-565		
HC26, HFC26 HYBRID	12. 8 ~	HN-517		HN-565		
FNPG26, FPC26	15.11 ~	HN-517		HN-565		
SILVIA						
S110, PS12, RPS12, PJS12, RPJS12	79. 3 ~ 88				FN-1148	
SKYLINE						
C210, R30 series	77. 8 ~ 85. 8				FN-1148	
2000 ZV37 Turbo	14. 6 ~	HN-621		HN-565		
2500 V36	9. 8 ~ 14. 2	HN-444		HN-565		
STANZA						
PA10, KPA10, FA10, WPA10	78 ~ 82				FN-1148	
SYLPHY						
1800 TB17	12.12 ~	HN-505			FN-1264	
TERRANO						
WD21 series	86. 8 ~ 95. 8				FN-1171	
2400 R20	96.05 ~ 05.06	HN-922				
	93.02 ~ 96.01	HN-922			FN-1225	
	96.07 ~ 99.07	HN-922			FN-1225	
	99.08 ~ 02.02	HN-922				
2700 R20	93.02 ~ 96.01	HN-922			FN-1225	
R20 EUR	98.01 ~ 02.02	HN-922				
	93.02 ~ 06.12	HN-922				
R20	96.07 ~ 00.05	HN-922			FN-1225	
3000 R20	02.03 ~ 05.06	HN-922				
TIIDA						
SC11X	07.02 ~	HN-474		HN-466		FN-1299
C11Z	07.11 ~ 09.02	HN-474				FN-1299
TIIDA・LATI0						
1200 N17T	12.10 ~	HN-555				

New Products

CAR MODEL

Model 車種形式	Year 年式	Front フロント		Rear リア		Parking パーキング
		Pad パッド	Shoe シュー	Pad パッド	Shoe シュー	Shoe シュー
TITAN USA						
5600 KING CAB	06.01 ~ 07.01	HN-961		HN-920		
TITAN KING CAB	08.01 ~			HN-920		
6000 KING CAB	06.01 ~ 07.01	HN-961				
VANETTE						
C120 series	78.10 ~ 88.11				FN-1148	
VERSA						
N17K	11.12 ~ 15.06	HN-949			FN-1286 or NA	
XTERRA						
4000 N50	05.01 ~ 07.01	HN-962				
X-TRAIL						
T30						FN-1903
T31	07.03 ~	HN-546		HN-466		FN-1299
T31R	09.10 ~	HN-546		HN-466		FN-1299
T31N	08.06 ~	HN-546		HN-466		FN-1299
T31P	10.03 ~	HN-546		HN-466		FN-1299
2000 NT32	5-seater 4WD	13.12 ~ 15. 8	HN-620		HN-565	
	5-seater 4WD	15. 8 ~	HN-620			
T32	5-seater	13.12 ~	HN-620		HN-565	
HT32, HNT32	Hybrid	15. 4 ~ 15. 8	HN-621		HN-565	
	Hybrid	15. 8 ~	HN-621			
NT32	7-seater 4WD	13.12 ~ 15. 8	HN-621		HN-565	
	7-seater 4WD	15. 8 ~	HN-621			
T32	7-seater	13.12 ~	HN-621		HN-565	
TOYOTA						
86						
2000 ZN6	G, RC	12. 4 ~	HN-579		HN-501	
	GT	12. 4 ~	HN-579		HN-611	
		14.11 ~	HN-579		HN-611	
4 RUNNER						
RZN18, VZN18		95 ~ 02			FN-2803	
AQUA						
1500 NHP10		11.12 ~	HN-567		FN-2389	
NHP10		14.04 ~			FN-2423	
AURIS						
1400 ZE15, RE15		07.03 ~	HN-713		HN-904	
1600 ZE15, RE15		07.03 ~	HN-713		HN-904	
NZE18, ZRE18		12.10 ~			HN-904	
1800 DBA-ZRE154H-BH		07.03 ~	HN-713		HN-904	
NZE18, ZRE18		12.10 ~			HN-904	
ZRE186H	Excl. RS	12. 8 ~	HN-524		HN-519	
	RS	12. 8 ~	HN-530		HN-519	

New Products

CAR MODEL

Model 車種形式	Year 年式	Front フロント		Rear リア		Parking パーキング
		Pad パッド	Shoe シュー	Pad パッド	Shoe シュー	Shoe シュー
AURIS						
2000 DBA-ZRE154H-BH	07.03 ~	HN-933		HN-904		
NZE18, ZRE18	12.10 ~			HN-904		
AVANZA						
1300 F601 MINI MPV	03.01 ~	HN-957			FN-2367	
MINI MPV	07.01 ~	HN-957			FN-2367	
1500 F601 MINI MPV	03.01 ~	HN-957			FN-2367	
Avensis						
ZZT221, AZT220, CDT220, CDT221	01.07 ~ 03.02					FN-2901
1600 AT220, ZZT220	97.01 ~ 01.04	HN-930			FN-2347	
ZZT250	03.03 ~ 08.01	HN-964				
1800 AT221, ZZT221	97.10 ~ 03.02	HN-930			FN-2347	
T25 STATION WAGON (EURO)	03.01 ~ 08.01	HN-964				
ZZT251	03.03 ~ 08.01	HN-964				
2000 CVT250, AZT250	03.10 ~ 08.01	HN-964				
AZT250W, 255W	03.10 ~ 08.01	HN-964				
T25 STATION WAGON (EURO)	03.01 ~ 08.01	HN-964				
STATION WAGON (EURO)	03.04 ~ 08.12	HN-964				
CDT220, CT220, S	97.10 ~ 03.02	HN-930			FN-2347	
2200 ADT225	05.09 ~ 08.01	HN-964				
2400 AZT241 (W)	05.06 ~ 08.01	HN-964				
T25 STATION WAGON (EURO)	03.01 ~ 08.12	HN-964				
AVENSIS (EURO)						
1600	97.01 ~ 01.00				FN-2347	
AVENSIS III (T27)						
1600 T27	09.05 ~	HN-933		HN-935		
1800 T27	09.05 ~	HN-933		HN-935		
2000 T27	09.05 ~	HN-933		HN-935		
2200 T27	09.05 ~			HN-935		
STATION WAGON	10.05 ~			HN-935		
SEDAN	10.05 ~			HN-935		
Camry						
2200 SXV10, 20	94.10 ~ 01.07	HN-228 or HN-322		HN-321 or N/A		FN-2901
ACV30	01.09 ~ 06.01	HN-479		HN-458		FN-2901
3000 MCV20	96.10 ~ 01.06	HN-401		HN-321		FN-2901
VCV10	91.06 ~ 96.07	HN-228		HN-321		FN-2901
CAMRY, AURION						
ACV40, GSV40	06.06 ~ 11.10	HN-970		HN-940		
ASV50, GSV50	11.10 ~	HN-970 or others		HN-940 or others		
COASTER						
BB10, RB11, RB13	77. 8 ~ 82. 5		FN-2265			
RU18, RU19	69. 2 ~ 77. 6					FN-2257

Model 車種形式	Year 年式	Front フロント		Rear リア		Parking パーキング
		Pad パッド	Shoe シュー	Pad パッド	Shoe シュー	Shoe シュー
COROLLA						
AE111, EE111, ZZE112, WZE110	97.05 ~ 01.10	HN-972, 952 or 322			FN-2311 or N/A	
1400 ZZE120	02.01 ~ 07.02	HN-951		HN-929 or N/A		
1600 ZZE121	04.01 ~ 07.02	HN-964 or HN-430		HN-929 or N/A		
	01.11 ~ 06.12	HN-951		HN-929 or N/A		
1800 ZZE123	01.11 ~ 06.01	HN-951		HN-929		
2000 CDE120	01.11 ~ 06.12	HN-951		HN-929		
COROLLA Axio						
NZE161.. 5D, NKE165, NZE164, ZRE162, NRE161	14.04 ~				FN-2423	
1300 NRE160	12. 5 ~	HN-508			FN-2383	
1500 NZE161	12. 5 ~	HN-508			FN-2383	
NZE164	12. 5 ~	HN-518			FN-2389	
NKE165 HYBRID	13. 8 ~	HN-567			FN-2389	
COROLLA FIELDER						
1500 NZE161G, NZE164G	12. 5 ~	HN-518			FN-2389	
NKE165G	13. 8 ~	HN-567			FN-2389	
1800 ZRE162G	12. 5 ~	HN-518			FN-2389	
COROLLA/VERSO						
1800 ZZE120J	04.06 ~ 09.03	HN-964				
2200 ZZE120J	05.10 ~ 09.03	HN-964				
CORONA						
RT40, RT80, RT90 series	64. 9 ~ 73.12		FN-2210		FN-2210	
CORONA MARK II						
RT60, RT70 series	68. 9 ~ 71.12		FN-2210		FN-2210	
CROWN						
MS60, RS60	71. 2 ~ 74. 9		FN-2249		FN-2249	
2000 ARS210	15. 9 ~	HN-550				
2500 AWS210	12.12 ~ 14. 7	HN-550		HN-494		
AWS210, AWS211	14. 7 ~	HN-550				
GRS210, GRS211	14. 7 ~	HN-550				
3500 GRS214	13. 8 ~	HN-547				
DYNA						
WU340, WU342, WU410, WU412, XZU330, XZU342, XZU412, BZU410			FN-2801 or others		FN-2802 or others	
DYNA・TOYOACE						
PK41, PK42	67. 5 ~ 71. 9		FN-2221		FN-2221	
10 series	72. 2 ~ 79. 3					FN-2257
20, 30 series DOUBLE TYRE	77. 8 ~ 85. 7		FN-2265			
2700 TRU600 3t	11. 6 ~	HN-329		HN-543		
TRC600, 600 2t FULL JUST LOW	11. 7 ~	HN-441		HN-543		

Model 車種形式		Year 年式	Front フロント		Rear リア		Parking パーキング
			Pad パッド	Shoe シュー	Pad パッド	Shoe シュー	Shoe シュー
DYNA・TOYOACE							
4000	XZC600	SINGLE TIRE	11.6 ~	HN-329			FN-2329
		DOUBLE TIRES	11.6 ~	HN-553		HN-553	
	XZC605, 605V		11.6 ~	HN-553		HN-553	
	XZC610D, 630D	MT	11.6 ~	HN-553		HN-553	FN-4443
	XZC610D, 630D	AT	11.6 ~	HN-553		HN-553	
	XZC645, 655		11.6 ~	HN-553		HN-553	
	XZC675, 675D		11.6 ~	HN-329		HN-453	FN-4443
	XZC710		11.6 ~	HN-329		HN-453	FN-0015
	XZU600	2t FULL JUST LOW	11.6 ~	HN-441		HN-543	
		2t HIGH FLOOR	11.6 ~	HN-329		HN-543	
	XZU600A, 600D		11.6 ~	HN-329		HN-543	
	XZU600H		11.6 ~	HN-329		HN-543	
	XZU600W		11.6 ~	HN-464		HN-464	
	XZU605		11.6 ~	HN-441		HN-543	
		3t FULL JUST LOW	11.6 ~	HN-329		HN-543	
		2t, 3t HIGH FLOOR, JUST LOW	11.6 ~	HN-329		HN-543	
	XZU610D	2t FULL JUST LOW	11.6 ~	HN-441		HN-543	
	XZU620D, 630D		11.6 ~	HN-329		HN-543	FN-4443
	XZU640		11.6 ~	HN-329		HN-543	
	XZU640W		11.6 ~	HN-464		HN-464	
	XZU645		11.6 ~	HN-441		HN-543	
	XZU650	2t FULL JUST LOW	11.6 ~	HN-441		HN-543	
		3t FULL JUST LOW	11.6 ~	HN-329		HN-543	
		2t, 3t HIGH FLOOR	11.6 ~	HN-329		HN-543	
		3.5t HIGH FLOOR	11.6 ~	HN-464		HN-464	FN-4443
	XZU650W	3.5t HIGH FLOOR	11.6 ~	HN-464		HN-464	FN-4443
	XZU655	2t FULL JUST LOW	11.6 ~	HN-441		HN-543	
		2t HIGH FLOOR, JUST LOW	11.6 ~	HN-329		HN-543	
	XZU675, 675D		11.6 ~	HN-329		HN-543	FN-4443
	XZU685, 695		11.6 ~	HN-329		HN-543	FN-4443
	XZU700	2t FULL JUST LOW	11.6 ~	HN-329		HN-543	FN-0015
		3t, 3.5t HIGH FLOOR, JUST LOW	11.6 ~	HN-464		HN-464	
	XZU700A		11.6 ~	HN-464		HN-464	FN-4466
	XZU710, 720	2t HIGH FLOOR, FULL JUST LOW	11.6 ~	HN-329		HN-543	
		3t, 3.5t HIGH FLOOR, JUST LOW	11.6 ~	HN-464		HN-464	
	XZU730		11.6 ~	HN-464		HN-464	FN-4466
	XZU775		11.6 ~	HN-329		HN-543	FN-4443
	XKU304H	2t, HYBRID	3.10 ~ 6.10	HN-329			FN-2329
	XKU600	2t FULL JUST LOW, HYBRID	11.6 ~	HN-441		HN-543	FN-0015
		3t FULL JUST LOW, HYBRID	11.6 ~	HN-329		HN-543	FN-0015
		2t, 3t HIGH FLOOR, JUST LOW, HYBRID	11.6 ~	HN-329		HN-543	FN-0015
	XKU605	2t FULL JUST LOW, HYBRID	11.6 ~	HN-441		HN-543	FN-0015
		2t HIGH FLOOR, JUST LOW, HYBRID	11.6 ~	HN-329		HN-543	FN-0015
	XKU640	HYBRID	11.6 ~	HN-329		HN-543	FN-0015
	XKU650	2t FULL JUST LOW, HYBRID	11.6 ~	HN-441		HN-543	FN-0015
		3t FULL JUST LOW, HYBRID	11.6 ~	HN-329		HN-543	FN-0015
		2t, 3t HIGH FLOOR, HYBRID	11.6 ~	HN-329		HN-543	FN-0015
	XKU655	2t FULL JUST LOW, HYBRID	11.6 ~	HN-441		HN-543	FN-0015
		2t HIGH FLOOR, HYBRID	11.6 ~	HN-329		HN-543	FN-0015

Model 車種形式		Year 年式	Front フロント		Rear リア		Parking パーキング
			Pad パッド	Shoe シュー	Pad パッド	Shoe シュー	Shoe シュー
DYNA・TOYOACE							
4000	XKU700 HYBRID	11.6 ~	HN-464		HN-464		
	XKU710, 720 2t HIGH FLOOR, FULL JUST LOW, HYBRID	11.6 ~	HN-329		HN-543		FN-0015
	3t, 3.5t, 4t HIGH FLOOR, JUST LOW, HYBRID	11.6 ~	HN-464		HN-464		
	XKU605 2t HIGH FLOOR, FULL JUST LOW, HYBRID	11.6 ~	HN-553		HN-553		
	XKU645 2t HIGH FLOOR, FULL JUST LOW, HYBRID	11.6 ~	HN-553		HN-553		
	XKC655 2t HIGH FLOOR, FULL JUST LOW, HYBRID	11.6 ~	HN-553		HN-553		
	XKU645 2t FULL JUST LOW, DUMP TRUCK, HYBRID	11.6 ~	HN-441		HN-543		
4100	XZU600 2t FULL JUST LOW, HYBRID	11.6 ~	HN-441		HN-543		
	3t, LPG	11.6 ~	HN-329		HN-543		
	BZU600A 2t LPG	11.6 ~	HN-329		HN-543		
FJ CLUISER							
4000	GSJ15W	10.11 ~	HN-482		HN-243		
	GSJ15	10.11 ~	HN-482		HN-243		FN-2904
FORTUNER							
2500	LAN5, KUN5	09.01 ~	HN-710			FN-2395	
2700	LAN5, KUN5	04.06 ~	HN-710			FN-2335	
HIACE							
	20, 30, 40 series	77.02 ~ 82.12		FN-2256		FN-2259	
	10 series	75.11 ~ 79.12				FN-2240	
HIACE COMMUTER							
		14 ~				FN-2803	
HI-LUX							
	RN20, RN30, RN40 series	72.5 ~ 83.11		FN-556 or NA		FN-2259	
HI-LUX VII/TACOMA							
2500	PICK-UP SUV	09.01 ~	HN-790				
2700	PICK-UP SUV	09.01 ~	HN-790				
3000	PICK-UP SUV	09.01 ~	HN-790				
4000	PICK-UP SUV	09.01 ~	HN-790				
HI-LUX VIII/TACOMA STOUT							
2500	PICK-UP SUV	01.01 ~ 05.01	HN-710				
2700	PICK-UP SUV/FLATBED/CHASIS	01.01 ~ 04.01	HN-710				
3000	PICK-UP SUV	01.01 ~ 05.01	HN-710				
3400	PICK-UP SUV/FLATBED/CHASIS	01.01 ~ 05.01	HN-710				
HI-LUX IX/TACOMA							
2000	PICK-UP SUV	07.12 ~	HN-710				
2500	PICK-UP SUV	07.12 ~	HN-710				
2700	PICK-UP SUV	07.12 ~	HN-710				
3000	PICK-UP SUV	07.12 ~	HN-710				
4000	PICK-UP SUV	07.12 ~	HN-710				

New Products

CAR MODEL

Model 車種形式	Year 年式	Front フロント		Rear リア		Parking パーキング
		Pad パッド	Shoe シュー	Pad パッド	Shoe シュー	Shoe シュー
HI-LUX SURF						
LN61, YN61	85. 8 ~ 86. 8				FN-2302	
KDN215, RZN21#, TRN21#, VZN21#	02.11 ~ 05.08	HN-482		HN-243		FN-2904
GRN215, TRN21#	05.08 ~	HN-482		HN-243		FN-2904
HI-LUX SURF(PICK UP)						
KUN15, LAN15, TGN15, TGN16, GGN15	11.07 ~	HN-968 or others			FN-2335 or others	
2000 GGN25, KUN20, 30	04.08 ~	HN-710			FN-2395	
LAN25, 35, TGN26	04.08 ~	HN-710			FN-2395	
2500 GGN15, KUN10	04.08 ~	HN-709			FN-2335	
TGN1, GGN2	07.12 ~	HN-710			FN-2395	
3000 KUN26L-PRMSYM	07.12 ~	HN-709			FN-2395	
HI-LUX VIGO						
2500 KUN20	02.01 ~	HN-710			FN-2395	
INOVA/KIJANG						
KUN40, TGN40, 41	04.08 ~	HN-834, HN-709, or NA			FN-2411, 2335 or NA	
2000 KUN40, TGN41	11.11 ~	HN-834			FN-2335	
2500 KUN40, TGN40	04.08 ~ 11.07	HN-834			FN-2335	
2700 KUN40, TGN40	04.08 ~ 11.07	HN-709			FN-2335	
IST						
NCP110.. CBU	14.04 ~				FN-2423	
JPN TAXI						
NTP10	17.10 ~				FN-2423	
KIJING TAMARAW						
LF20, LF30	81 ~ 86		FN-2256		FN-2259	
KF10	76 ~ 81		FN-2210		FN-2210	
LAND CRUISER						
BJ45, HJ47, FJ45	80. 8 ~ 82. 9				FN-2279	
FJ60 series FIRE ENGINE	80.11 ~ 84.11				FN-2279	
J40 series	69. 3 ~ 80. 7		FN-2221		FN-2221	
J40, J60 series	75. 9 ~ 87. 8		FN-2255		FN-2255	
FRONT BRAKE SHOE TYPE	80. 8 ~ 85. 6					FN-2257
HZJ74, 76.. ZX	99.08 ~ 04.08	HN-411 or others		FN-2280, HN-243 or others		FN-2904
LAND CRUISER PRADE						
KZJ9#, RZJ9#, VZJ9#	96.04 ~ 99.06	HN-387		HN-243		FN-2904
KDJ9#, KZJ9#, RZJ9#, VZJ9#	99.06 ~ 02.11	HN-387		HN-243		FN-2904
GRJ12#, KDJ121, 125, RZJ12#, TRJ12#, VZJ12#	02.09 ~ 07.07	HN-482		HN-243		FN-2904
KDJ120	02.09 ~ 07.07	HN-482		HN-243		FN-2904
GRJ15#, TRJ150	09.08 ~ 13.08	HN-482		HN-243		FN-2904
	13.08 ~	HN-482		HN-243		FN-2904
2800 GDJ150W, GDJ151W	15. 6 ~	HN-482		HN-243		

New Products

CAR MODEL

Model 車種形式	Year 年式	Front フロント		Rear リア		Parking パーキング
		Pad パッド	Shoe シュー	Pad パッド	Shoe シュー	Shoe シュー
MATRIX						
AZE144, AZE146	08.01 ~ 11.11	HN-530		HN-522		FN-1299
MIRAI						
FCV JPD10	14.12 ~	HN-530		HN-569		
NOAH・VOXY						
1800 ZER80G, W G, V, X, HYBRID	14.1 ~	HN-524				
2000 ZRR80G, 85G,	14.1 ~	HN-524			FN-2371	
4WD	14.1 ~	HN-524				
2000 ZRR80W, 85W Si, ZS	14.1 ~	HN-524				
V, X	14.1 ~	HN-524			FN-2371	
PIXIS EPOCH						
660 LA300A	12.5 ~	HN-428				
LA310A	12.5 ~	HN-428			FN-0043	
PIXIS MEGA						
660 LA700A	15.7 ~				FN-2397	
LA710A	15.7 ~				FN-0043	
PIXIS SPACE						
660 L575A	11.9 ~ 12.4	HN-428			FN-0027	
Custom RS ~0028111	12.4 ~ 13.6	HN-492				
0028112~	13.7 ~	HN-492				
Excl. Custom RS ~0028106	12.4 ~ 13.6	HN-428			FN-0027	
0028107~	13.7 ~	HN-428				
L585A Custom RS	11.9 ~	HN-492			FN-0043	
Excl. Custom RS ~0005998	11.9 ~ 12.4	HN-428			FN-0043	
0005999~	12.4 ~	HN-492			FN-0043	
PIXIS TRUCK						
660 S201U, S211U	11.11 ~ 14.8	HN-512			FN-0038	
S500U, S510U	14.9 ~	HN-512			FN-0038	
PIXIS VAN						
660 S321M, S331M	11.12 ~ 14.5	HN-512			FN-0038	
	14.5 ~	HN-512			FN-0038 or FN-0041	
PORTE・SPADE						
1300 NSP140	12.7 ~ 14.4	HN-508			FN-2342	
	14.4 ~	HN-508			FN-2389	
1500 NCP141	12.7 ~ 14.4	HN-508			FN-2389	
	14.4 ~	HN-508			FN-2423	
NCP145 4WD	12.7 ~ 14.4	HN-518			FN-2389	
	14.4 ~	HN-518			FN-2423	
NSP141	15.7 ~	HN-508			FN-2423	
PREMIO・ARION						
ZRT261, 265	14.04 ~				FN-2423	

New Products

CAR MODEL

Model 車種形式	Year 年式	Front フロント		Rear リア		Parking パーキング
		Pad パッド	Shoe シュー	Pad パッド	Shoe シュー	Shoe シュー
PRIUS EX GRADE						
1500 NHW20	09. 6 ~ 11.12	HN-472				FN-2383
RACTIS						
	05 ~ 10	HN-976				
1300 NSP120, 122	10.11 ~ 14. 4	HN-518				FN-2389
	14. 4 ~	HN-518				
1500 NCP120, 122, 125	10.11 ~ 14. 4	HN-518				FN-2389
NCP120 S package	10.11 ~	HN-518		HN-519		
NCP120, 122, 125	14. 4 ~	HN-518				
RAV4						
ACA30 SERIES, ALA30 SERIES, GSA33, ZSA30, ZSA35	05.11 ~ 12.12	HN-530 or HN-524			HN-522	FN-1299
ALA40, ALA49, ZSA44	12.12 ~	HN-530 or N/A			HN-522	FN-1299
ACA33L-A, ASA33L-A, ACA38L-A	05.11 ~	HN-530 or HN-524			HN-522	FN-1299
GSA33L-A, ACA38L-A	06.01 ~ 12.12	HN-530			HN-522	FN-1299
ASA33L-C, GSA33L-C, ASA38L-C	08.11 ~ 12.12	HN-530 or HN-524			HN-522	FN-1299
ASA42L, ASA44L	12.12 ~	HN-530 or HN-524			HN-522	FN-1299
ASA42, ASA44, ZSA42, ZSA44	12.12 ~	HN-530			HN-522	FN-1299
ACA20, CLA20, ZCA25	04.02 ~ 05.11	HN-447				FN-2404
ACA21, CLA21, ZCA26	02.08 ~ 05.11	HN-447				FN-2404
RAV4・VANGUARD						
ACA20W, 21W, ZCA25W, 26W	02.08 ~ 03.07	HN-447				FN-2404
ACA20W, ZCA25W	04.02 ~ 05.11	HN-447				FN-2404
ACA21W, ZCA26W	03.07 ~ 05.11	HN-447				FN-2404
SPRINTER						
AE80, 81, 82, CE80, EE80	83.05 ~ 87.05					FN-2288
STOUT						
RK101	67. 9 ~ 79. 3		FN-2221			FN-2221
TACOMA						
2500 PICK-UP SUV	01.01 ~ 05.12	HN-710				
2700 PICK-UP SUV	01.01 ~ 05.12	HN-710				
3000 PICK-UP SUV	02.01 ~ 05.12	HN-710				
3400 PICK-UP SUV	01.01 ~ 05.12	HN-710				
TACOMA(USA)						
2400 PICK-UP TRUCK	02.01 ~ 04.01					
2700 PICK-UP TRUCK	02.01 ~ 04.01					
3400 PICK-UP TRUCK	02.01 ~ 04.01					
TUNDRA						
GSK30, UCK3#, 4#, VCK30, 40	04 ~ 06					FN-2803
VERSO S						
2200 ZGR2	09.04 ~	HN-933				

New Products

CAR MODEL

Model 車種形式	Year 年式	Front フロント		Rear リア		Parking パーキング
		Pad パッド	Shoe シュー	Pad パッド	Shoe シュー	Shoe シュー
VIOS						
NCP150, 151	13.04 ~	HN-969 or others			FN-2383 or others	
VITS						
NHP130..	17. ~				FN-2423	
1000 KSP130	12. 5 ~				FN-2383	
1300 NSP135 4WD	10.12 ~	HN-508			FN-2383	
1500 NCP131 RS G's	10.12 ~			HN-519		
RS	10.12 ~	HN-518		HN-519		
Excl. RS	10.12 ~	HN-508			FN-2383	
WISH						
ZGE20.. 18X	14.04 ~				FN-2423	
YARIS						
NHP13#, NSP13#, NCP13#, KSP13#, NLP13#	11 ~	HN-976				
SCP9#, NSP9#, KSP9#, ZSP9#	05 ~	HN-976				
NCP150, 151	13. 8 ~	HN-969 or others			FN-2383 or others	
1000 SCP10	01.01 ~ 04.12	HN-703			FN-2386	
1400 NLP10, SCP10	01.01 ~ 09.06	HN-703			FN-2386	
YARIS(EURO)						
1400 NLP	01.01 ~ 05.06	HN-703		HN-454		
1500 SCP, NCP	01.01 ~ 04.12	HN-703		HN-454		
YARIS VERSO(EURO)						
1300 NCP20/22	01.01 ~ 04.12	HN-703				
1400 NLP20	01.01 ~ 04.12	HN-703				
1500 NCP21	01.01 ~ 04.12	HN-703				
MAZDA						
ATENZA (Mazda 6) Sedan						
2000 GJEFP, GJEFW	12.11 ~	HN-602		HN-603		
2200 GJ2FP, GJ2FW	12.11 ~	HN-602		HN-603		
2500 GJ5FP, GJ5FW	12.11 ~	HN-602		HN-603		
GH5FW SPORT WAGON	08.01 ~	HN-942				
AXELA (Mazda 3)						
BK3P	03.10 ~ 09.05	HN-507		HN-967		
2000 BYEFP Hybrid	13.11 ~	HN-602		HN-603		
1500 BM5AP, BM5FP	13.11 ~	HN-615		HN-616		
BM5AS, BM5FS Sports 5-door	13.11 ~	HN-615		HN-616		
2000 BMEFS Sports 5-door	13.11 ~	HN-615		HN-616		
2200 BM2FS Sports 5-door	14. 1 ~	HN-615		HN-616		
B2200						
UN1, UN8	99.02 ~	HN-965			FN-3357	
B2500						
UN1, UN8	99.02 ~	HN-965			FN-3413	

New Products

CAR MODEL

Model 車種形式	Year 年式	Front フロント		Rear リア		Parking パーキング
		Pad パッド	Shoe シュー	Pad パッド	Shoe シュー	Shoe シュー
B2500						
2500 UG71, UG74, UJ74	96.04 ~ 98.07	HN-953			FN-3378	
	04.01 ~	HN-956			FN-3413	
B2600						
2600 UG72, UK51	96.04 ~ 98.07	HN-953				
UN8	99.02 ~	HN-965			FN-3416	
B2900						
2900	04.01 ~	HN-956			FN-3413	
BIANTE						
CCEFW, CCEAW	08.07 ~ 10.09	HN-507		HN-967		
CC3FW	08.07 ~ 13.05	HN-507		HN-967		
BONGO						
1800 SKP2L, SKP2M, SKP2T, SKP2V	10. 8 ~	HN-332			FN-3426	
BT-50						
J97M	07.01 ~ 11.10	HN-965			FN-3416	
BT-50 II						
	11.11 ~	HN-966				
CAPELLA						
SNA (105507-), CB2VS(-152667) TAXI	72. 7 ~ 82.12		FN-3324		FN-3324	
CAROL						
660 HB36S	15. 1 ~	HN-582				
CX-3						
1500 DK5AW, DK5FW	15. 2 ~	HN-615		HN-601		
CX-5						
2000 KEEAW, KEEFW	12. 2 ~	HN-600		HN-601		
2200 KE2AW, KE2FW	12. 2 ~	HN-600		HN-601		
2500 KE5AW, KE5FW	12. 2 ~	HN-600		HN-601		
FAMILIA						
FA2, FA3	73. 1 ~ 78. 1		FN-3324		FN-3324	
FINDER						
2500	02.01 ~	HN-956				
FLAIR						
660 MJ34S	12.10 ~	HN-566			FN-9999	
MJ44S	14.08 ~	HN-566			FN-9999	
MJ55S	17.02 ~				FN-9999	

New Products

CAR MODEL

Model 車種形式		Year 年式	Front フロント		Rear リア		Parking パーキング
			Pad パッド	Shoe シュー	Pad パッド	Shoe シュー	Shoe シュー
FLAIR CROSSOVER							
660	MS31S	14.01 ~ 15.12	HN-566				FN-9999
	MS41S	15.05 ~					FN-9999
	MJ41S	15. 5 ~	HN-566				
FLAIR WAGON							
660	MM21S	12.06 ~ 13.04	HN-566				FN-9999
	MM32S	13.03 ~ 15.05	HN-566				FN-9999
	MM42S	15.05 ~	HN-566				FN-9999
LUCE							
	LA2, LA3, LA4 series	72.11 ~ 79.10		FN-3324			FN-3324
MAZDA 3							
	BK12, BK14	03.10 ~ 09.01	HN-507		HN-967		
	BL	09.05 ~	HN-507		HN-967		
MAZDA 5							
	CR	05.03 ~ 10.01	HN-507		HN-967		
	CW	10.06 ~	HN-507		HN-967		
MAZDA 6							
1800	L8 ESTATE/WAGON	06.01 ~ 07.01	HN-942				
MAZDA 6/ATENZA							
2300	GG3S	05.01 ~ 08.01	HN-942				
PROCEED							
	BTA67, BNA61, PE2N6, PE2V6	65. 8 ~ 79.10		FN-3326			FN-3326
RX-7							
	SA22C	79 ~ 80		FN-3324			FN-3324
RX-8							
1300	SE3P	03.05 ~	HN-947				
RX-8(USA)							
2600		04.01 ~	HN-947				
SCRUM							
660	DG16T TRUCK	13. 9 ~	HN-566				FN-9966
TELSTAR							
	CB2N, CB2M	78 ~ 80		FN-3324			FN-3324
	CB2N, CB2V, CB2M (EUR, UK)	80 ~ 81					FN-3344
TITAN							
2000	SYF4L SINGLE TIRES	4. 8 ~	HN-376				
	DOUBLE TIRES	4. 8 ~	HN-376				FN-3426

New Products

CAR MODEL

Model 車種形式		Year 年式	Front フロント		Rear リア		Parking パーキング
			Pad パッド	Shoe シュー	Pad パッド	Shoe シュー	Shoe シュー
TRIBUTE							
2000	TA-EPEW	01.01 ~ 03.11	HN-939			FN-3382	
2300	TA-EP3W	03.12 ~ 05.10	HN-939				
3000	LA-EPFW	01.01 ~ 03.11	HN-939			FN-3382	
TRIBUTE(USA)							
2000	SUV	01.01 ~ 04.01	HN-939			FN-3382	
2500	SUV	06.01 ~ 10.12	HN-939				
3000	SUV	01.01 ~ 04.01	HN-939			FN-3382	
ISUZU							
COMO							
2000	JVRE26	12. 7 ~	HN-475				
	JVW2E26, JVW6E26	12. 7 ~	HN-475				
	JCS4E26, JCW4E26	12. 7 ~	HN-475				
	JCW8E26	12. 7 ~	HN-475				
	JDS4E26, JDW4E26	MICROBUS	12. 7 ~	HN-475			
ELF							
	TLD40, 50, 60, 70 series	79. 1 ~ 83. 3		FN-4429		FN-4429	
	NPR57, NPR59, NRR12	86. 9 ~					FN-4433
3000	ATZ2F24	SINGLE TIRE	7. 7 ~	HN-475		FN-1208	
		DOUBLE TIRES	7. 7 ~	HN-475		FN-6655	
	ASZ4F24, ASZ5F24	SINGLE TIRE	7. 7 ~	HN-475		FN-1208	
		DOUBLE TIRES	7. 7 ~	HN-475		FN-6655	
	NHR85	INDEPENDENT SUS. SINGLE TIRE	7. 2 ~ 11. 8	HN-543	FN-4459	FN-4461	FN-4443
		INDEPENDENT SUS. DOUBLE TIRES	7. 2 ~ 11. 8	HN-543	FN-4459	FN-4465	FN-4443
		EXCL. INDEPENDENT SUS., SINGLE CABIN SINGLE TIRE	7. 2 ~ 11. 8	HN-543	FN-4459	FN-4461	FN-4443
		EXCL. INDEPENDENT SUS., SINGLE CABIN DOUBLE TIRES	7. 2 ~ 11. 8	HN-543	FN-4459	FN-4465	FN-4443
		SINGLE TIRE	11. 8 ~	HN-543		FN-4461	FN-4443
		DOUBLE TIRES	11. 8 ~	HN-543		FN-4465	FN-4443
	NHS85		11. 8 ~	HN-543		FN-4461	FN-4443
	NJR85	INDEPENDENT SUS., SINGLE CABIN	7. 2 ~ 10	HN-543	FN-4459	*	FN-4443
		INDEPENDENT SUS., SINGLE CABIN SINGLE TIRE	11. 4 ~	HN-543		FN-4461	FN-4443
		INDEPENDENT SUS., SINGLE CABIN DOUBLE TIRES	11. 4 ~	HN-543		FN-4465	FN-4443
		INDEPENDENT SUS., HYBRID	7. 7 ~	HN-543		FN-4461	FN-4443
		INDEPENDENT SUS., DOUBLE CABIN SINGLE TIRE	7. 2 ~ 10	HN-543		FN-4461	FN-4443
		INDEPENDENT SUS., DOUBLE CABIN DOUBLE TIRES	7. 2 ~	HN-543		FN-4465	FN-4443
		INDEPENDENT SUS., SINGLE CABIN	7. 2 ~ 10	HN-464		*	FN-4443
		EXCL. INDEPENDENT SUS., SINGLE CABIN	11. 4 ~	HN-464		FN-4451	FN-4443
		EXCL. INDEPENDENT SUS., DOUBLE CABIN	7. 2 ~ 10	HN-464		FN-4451	FN-4443
		EXCL. INDEPENDENT SUS., HYBRID	7. 7 ~	HN-464		FN-4451	FN-4443
*REAR DRUM FN-4451, FN-4461 or FN-4465.							
	NKS85	2t, DUMP TRUCK	7. 2 ~ 12.12	HN-464		FN-4451	FN-4443
			13. 1 ~			FN-4451	FN-4443
		EXCL. DUMP TRUCK	7. 2 ~	HN-543		FN-4451	FN-4443
		3t	7. 2 ~ 12.12	HN-464		FN-4459	FN-4443
			13. 1 ~			FN-4459	FN-4443
	NLR82	INDEPENDENT SUS., CNG	7. 7 ~	HN-543		FN-4461	FN-4443
		EXCL. INDEPENDENT SUS., CNG	7. 7 ~	HN-464	FN-4459	FN-4451	FN-4443

New Products

CAR MODEL

Model 車種形式		Year 年式	Front フロント		Rear リア		Parking パーキング	
			Pad パッド	Shoe シュー	Pad パッド	Shoe シュー	Shoe シュー	
ELF								
3000	NLR85	INDEPENDENT SUS.	6.11 ~	HN-543			FN-4461	FN-4443
		EXCL. INDEPENDENT SUS.	6.11 ~	HN-464			FN-4451	FN-4443
	NLS85		6.11 ~	HN-543			FN-4451	FN-4443
	NNR85, NNS85		6.12 ~				FN-4451	FN-4443
	NPR85	SINGLE CABIN, with HYDRAULICALLY ASSISTED BRAKE	6.12 ~	HN-491	FN-4459		FN-4459	FN-4443
		without HYDRAULICALLY ASSISTED BRAKE	6.12 ~	HN-464	FN-4459		FN-4459	FN-4443
		DOUBLE CABIN	6.12 ~ 9. 2	HN-464			FN-4459	FN-4443
	NPS85		6.12 ~ 9. 2	HN-464			FN-4459	FN-4443
		with HYDRAULICALLY ASSISTED BRAKE	9. 2 ~	HN-491			FN-4459	FN-4443
		without HYDRAULICALLY ASSISTED BRAKE	9. 2 ~	HN-464			FN-4459	FN-4443
4600	NPR82	with HYDRAULICALLY ASSISTED BRAKE	9. 2 ~	HN-491	FN-4459		FN-4459	FN-4443
		without HYDRAULICALLY ASSISTED BRAKE	9. 2 ~	HN-464	FN-4459		FN-4459	FN-4443
5000	NPR72		99.04 ~	HN-963			FN-4459	
5200	NPR75		99.04 ~	HN-963			FN-4459	
MU, WIZARD								
3000	MU7		07.03 ~	HN-721				
HONDA								
ODYSSEY								
			02.01 ~ 04.01				HN-982	
ACCORD								
2000	CU1, CW1		8.12 ~ 13. 6	HN-614			HN-604	
	CR6, 7	Hybrid	13.06 ~	HN-609			HN-580	
2400	CU2		8.12 ~ 11. 2	HN-445			HN-604	
ACCORD VIII/IX TOURER								
2000	CP, CU, CW		08.01 ~				HN-918	
2200	CP, CU, CW, IX E		08.01 ~				HN-918	
2400	CP, CU, CW		08.01 ~				HN-918	
ACCORD(EURO)								
2000			03.01 ~ 08.12	HN-937				
2200			04.01 ~ 08.12	HN-937			HN-397	
2400			03.01 ~ 08.12	HN-937			HN-397	
BALLADE								
	SS, ST		80. 8 ~ 83. 9				FN-5510	
CITY								
	AA, FA, VF		81.11 ~ 86.10				FN-5510	
CITY (EUR,GEN)								
	4DOOR		06 ~				FN-5547	
	4DOOR		09 ~				FN-5547	
CIVIC								
	SB, SL, SS, SR, ST		79. 7 ~ 83. 9				FN-5510	

New Products

CAR MODEL

Model 車種形式		Year 年式	Front フロント		Rear リア		Parking パーキング
			Pad パッド	Shoe シュー	Pad パッド	Shoe シュー	Shoe シュー
CIVIC (USA)							
FA1		06 ~				FN-5547	
CIVIC VI(EURO)							
1300	HATCHBACK, SED	06.01 ~			HN-943		
1400	HATCHBACK, SED	06.01 ~			HN-943		
1600	HATCHBACK, SED	05.01 ~			HN-943		
	HATCHBACK, SED	06.01 ~			HN-943		
1800	HATCHBACK, SED	05.01 ~			HN-943		
	HATCHBACK, SED	06.01 ~			HN-943		
2000	HATCHBACK TYPE	06.01 ~			HN-943		
2200	HATCHBACK, SED	06.01 ~			HN-943		
CIVIC COUNTRY							
WD		80. 1 ~ 83. 9				FN-5514	
CR-V							
		07 ~	HN-559 or HN-913		HN-255 or HN-985		
		07 ~					FN-5901
CR-V I-CTDI							
		07 ~ 09	HN-913		HN-985		
CR-V I-DTEC							
		10 ~	HN-913		HN-985		
CR-V III							
2000	DBA-RE3, RE4	07.01 ~	HN-913				
2200	DBA-RE3, RE4	07.01 ~	HN-913				
2400	DBA-RE3, RE4	07.01 ~	HN-913				
FIT							
GE06		07.10 ~				FN-5547	
1300	GK3, GK4	13.09 ~	HN-560			FN-5547	
	GP1 HYBRID	10.10 ~ 13. 9	HN-560			FN-5547	
1500	GK5 Rear drum brake	13.09 ~	HN-560			FN-5547	
	Rear disc brake	13.09 ~	HN-560		HN-266		
	GK6, GP5, GP6	13.09 ~	HN-560			FN-5547	
	GP4 HYBRID	12.05 ~ 13. 9	HN-560		HN-397		
Grace							
1500	GM4, 5	14.12 ~	HN-560			FN-5547	
	GM6, 9	15.06 ~	HN-560			FN-5547	
INSIGHT (USA)							
		10 ~				FN-5547	
INSPIRE							
3500	CP3	7.12 ~ 12. 9	HN-445		HN-604		

New Products

CAR MODEL

Model 車種形式	Year 年式	Front フロント		Rear リア		Parking パーキング
		Pad パッド	Shoe シュー	Pad パッド	Shoe シュー	Shoe シュー
JADE						
1500 FR4, 5	15. 2 ~	HN-485		HN-580		
JAZZ						
AA, VF	84 ~ 86				FN-5510	
JAZZ (EUR)						
5D00R	09 ~				FN-5547	
JAZZ HYBRID (EUR)						
	12 ~				FN-5547	
LAGREAT						
3500 RL1	01.11 ~ 04.05	HN-916				
MR-V						
	03.01 ~ 08.01			HN-982		
N-BOX						
660 JF1	Excl. Turbo ~1400000	11.12 ~ 13.12	HN-336			FN-5541
	Turbo	11.12 ~	HN-558			FN-5541
	Excl. Turbo 1400001~	13.12 ~				FN-5541
	JF2	13.12 ~	HN-558			FN-5541
N-BOX+						
660 JF1, 2		12.07 ~	HN-558			FN-5541
N-ONE						
660 JG1, 2	~1100000	12.11 ~ 14.05	HN-336			FN-5541
	1100000~	14.05 ~				FN-5541
	TURBO	12.11 ~	HN-558			FN-5541
N-WGN						
660 JH1, 2		13.11 ~				FN-5541
	TURBO	13.11 ~	HN-558			FN-5541
ODYSSEY						
2000 RC4	Hybrid	16. 2 ~	HN-609		HN-580	
2400 RC1, RC2		13.11 ~	HN-609		HN-580	
PRELUDE						
AB		82.11 ~ 87.05				FN-5516
SN		78.11 ~ 82.11				FN-5510 or FN-5514
QUINT						
SU		80. 2 ~ 84. 2				FN-5510

New Products

CAR MODEL

Model 車種形式	Year 年式	Front フロント		Rear リア		Parking パーキング
		Pad パッド	Shoe シュー	Pad パッド	Shoe シュー	Shoe シュー
SHUTTLE						
1500 GK8 Wagon	15. 5 ~	HN-560			FN-5547	
GK9 Wagon 4WD	15. 5 ~	HN-560			FN-5547	
GP7 Wagon Hybrid	15. 5 ~	HN-560			FN-5524	
GP8 Wagon Hybrid 4WD	15. 5 ~	HN-560			FN-5524	
STEP WGN						
1500 RP1, RP2, RP3, RP4	15. 4 ~	HN-609		HN-580		
VEZEL						
1500 RU1, RU2, RU3, RU4	13.12 ~	HN-609				
VIGOR						
AC, AD, SY, SZ	81.09 ~ 85.06				FN-5516	
mitsubishi						
CANTER						
3000 FEB73	13. 8 ~	HN-575		HN-575		FN-6680
FBA00	10.11 ~					FN-6680
FEBMO	15. 4 ~	HN-575		HN-575		FN-6680
FED90K	14.12 ~	HN-575		HN-575		FN-6680
FB70B	9. 5 ~	HN-576		HN-576		
FD70B SINGLE TIRE	9. 5 ~	HN-515		HN-515		
DOUBLE TIRE	9. 5 ~	HN-576		HN-576		
FE70B, FE72B 2t	9. 4 ~ 11. 9	HN-572			FN-6602	
3t	9. 4 ~ 11. 9	HN-571			FN-6653	
FE71B	9. 4 ~ 11. 9	HN-572		HN-572	FN-6602	FN-6680
FE73B	9. 4 ~ 11. 9	HN-571			FN-6653	FN-6680
FE74B 2t	4. 4 ~ 9. 4	HN-514			FN-6602	
	9. 4 ~ 11. 9	HN-572, 513 or 571			FN-6602, 6653 or 6722	
FE82B 2t	9. 4 ~ 11.11	HN-572			FN-6602	
3t	9. 4 ~ 11.11	HN-531				
FE84B	9. 4 ~ 11.11	HN-572, 514 or 513			FN-6602 or 6722	
FBA20, FEA20, FEB20	10.11 ~	HN-574		HN-573		FN-6680
FBA30, FBA60, FEA50, FEA53, FEA70, FEA80, FEB50, FEB70, FEB80, FEB90, FEC90	10.11 ~	HN-575		HN-575		FN-6680
FDA00, FDA20, FDA40	10. 6 ~	HN-574		HN-573		
FEA13	12. 5 ~	HN-575		HN-575		FN-6680
FGA20	11. 6 ~	HN-573		HN-573		FN-6680
FGB70	11. 6 ~		FN-6653		FN-6653	FN-6680
3300 FGB70	85.09 ~ 93.10	HN-981 or NA				
3600 FGB70	85.09 ~ 93.10	HN-981 or NA				
4900 FE70D, FE71D, FE72D, FE74D 2t	4. 2 ~ 9. 4	HN-514			FN-6602	
	9. 4 ~	HN-572			FN-6602	
3t	4. 2 ~ 9. 4	HN-513			FN-6653	
	9. 4 ~	HN-571			FN-6653	
FE71D 2T Double cab	4. 2 ~ 9. 4	HN-514		HN-514		
FE73D	4. 2 ~ 9. 4	HN-513	FN-6653	HN-513	FN-6653	
	9. 5 ~	HN-571			FN-6653	

New Products

CAR MODEL

Model 車種形式		Year 年式	Front フロント		Rear リア		Parking パーキング
			Pad パッド	Shoe シュー	Pad パッド	Shoe シュー	Shoe シュー
CANTER							
4900 FE83D	2t, 3t, Reinforcement type	9.5 ~		FN-6722		FN-6722	FN-4443
	3.5~4t	2.5 ~ 9.4	HN-513				
		9.5 ~		FN-6722		FN-6722	FN-4443
FG70D, FG74D, FE84D, FG84D	2t	9.5 ~	HN-572			FN-6602	
	3t	9.5 ~	HN-571			FN-6653	
FG84D		7.6 ~ 9.4	HN-514			FN-6602	
CANTER GUTS							
3000 BSZ1F24	1.15~1.5t 2WD A flat single tire / double tires	13.1 ~	HN-475			FN-1208	
	1.25~1.5t 2WD Small-diameter double tires	13.1 ~	HN-475			FN-6655	
BSZ2F24	1.15~1.5t 2WD A flat single tire / double tires	13.1 ~	HN-475			FN-1208	
	1.25~1.5t 2WD Small-diameter double tires	13.1 ~	HN-475			FN-6655	
BSZ4F24	1.15~1.5t 4WD A flat single tire / double tires	13.1 ~	HN-475			FN-1208	
BSZ5F24	1.15~1.5t 4WD A flat single tire / double tires	13.1 ~	HN-475			FN-1208	
FB70B		4.7 ~ 9.4	HN-515		HN-515		
	Full low floor 2WD Single Cab · Double Cab	9.5 ~ 10.11	HN-576		HN-576		FN-6680
FD70B		4.7 ~ 9.4	HN-515		HN-515		
	Full low floor 4WD Single Cab / Single tire · Double Cab	9.5 ~ 10.11	HN-515		HN-515		
	Full low floor 4WD Single Cab / Double tires	9.5 ~ 10.11	HN-576		HN-576		
COLT							
1300 Z21W	PLUS	4.10 ~ 12.6	HN-500			FN-1267	
Z22W	PLUS	4.10 ~ 12.6	HN-500			FN-6729	
eK custom							
660 B11W		13.6 ~	HN-570			FN-6726	
	TURBO	13.6 ~	HN-566			FN-6726	
ek SPACE							
660 B11A	2WD, CUSTOM 2WD	14.2 ~	HN-570			FN-6726	
	4WD, CUSTOM 4WD, CUSTOM TURBO	14.2 ~	HN-566			FN-6726	
i-MiEV							
HA4W		13.1 ~				FN-1267	
L200							
2000 K62T	Crewcab	00.06 ~ 01.07	HN-954			FN-6715	
2400 K75T		00.06 ~ 01.07	HN-954			FN-6718	
2500 K75T	TWINCAB	00.01 ~ 05.06	HN-702				
	Crewcab	00.06 ~ 05.06	HN-954				
K64T		00.06 ~ 01.07	HN-954			FN-6715	
K74T		00.06 ~ 01.07	HN-954			FN-6718	
KB4		05.06 ~ 10.04	HN-960			FN-6741	
KB4T		05.01 ~ 10.04	HN-960			FN-6741	
		10.04 ~	HN-960			FN-6741	
		07.10 ~	HN-960			FN-6741	
MINICAB MiEV							
660 U67V		11.12 ~	HN-437			FN-1267	

New Products

CAR MODEL

Model 車種形式	Year 年式	Front フロント		Rear リア		Parking パーキング
		Pad パッド	Shoe シュー	Pad パッド	Shoe シュー	Shoe シュー
MINICAB MiEV						
660 U68V, 68T	13. 1 ~ 14. 9	HN-437			FN-1267	
	14.10 ~	HN-570			FN-1267	
OUTLANDER						
2000 CF7W, 8W	12.10 ~	HN-548		HN-603		
GG2W	13. 1 ~ 15. 6	HN-548		HN-603		
	15. 7 ~	HN-233		HN-603		
PAJERO III						
	00 ~ 05					FN-6904
PAJERO IO						
	99 ~ 02					FN-6704
PAJERO SPORT						
2500 KH4W, KH6W	08.07 ~ 13.02	HN-960				
	98 ~					FN-6901
RVR ASX, Outlander sport						
1800 GA3W, GA4W	12. 1 ~	HN-548		HN-603		
STAKER						
2500 K64T	00.06 ~ 01.07	HN-954			FN-6715	
TRITON/L200						
3500 ABF-KB7T	06.09 ~ 11.09	HN-960			FN-6741	
ZINGER						
2400	06.01 ~	HN-960				
SUBARU						
BRZ						
2000 ZC6	RA Racing, R, S W/ LSD	11.11 ~ 13.08	HN-579			
	RA, R W/O LSD	11.11 ~ 13.08	HN-579		HN-501	
	RA, R W/O LSD	13.08 ~	HN-579			
	RA Racing, S (EXCL. TS)	13.08 ~	HN-579			
	S, RA Racing, R (With LSD)	11.11 ~ 13. 8	HN-579		HN-611	
	R, RA (Without LSD), RA Racing, S (Excl. TS)	13. 8 ~	HN-579		HN-611	
	R Customize Package	15. 4 ~	HN-579		HN-611	
EXIGA						
2000 YA4, YA5		08.06 ~ 10.05	HN-460		HN-501	
		10.05 ~ 12.06	HN-579		HN-501	
2500 YA9	003832~	10.05 ~ 12.06	HN-579		HN-501	
YAM		12.07 ~	HN-579		HN-501	
FORESTER						
2000 SHJ		10.10 ~ 12.11	HN-579		HN-501	
SJ5		12.11 ~	HN-579		HN-501	

New Products

CAR MODEL

Model 車種形式	Year 年式	Front フロント		Rear リア		Parking パーキング
		Pad パッド	Shoe シュー	Pad パッド	Shoe シュー	Shoe シュー
FORESTER						
2000 SJG	12.11 ~	HN-499		HN-611		
IMPREZA						
1500 GH2	07.06 ~ 11.12	HN-493				
~038768	09.09 ~ 10.05	HN-460				
038771~	10.05 ~ 11.12	HN-579		HN-501		
GH3	07.06 ~ 11.12	HN-493				
~016407	09.09 ~ 10.05	HN-460		HN-501		
016414~	10.05 ~ 11.12	HN-579		HN-501		
1600 GP2, GP3	11.12 ~			HN-501		
2000 GH6	~003087	08.10 ~ 10.05	HN-460		HN-501	
003088~	10.05 ~ 11.12	HN-579			HN-501	
GH7, GH8	07.03 ~ 10.05	HN-460			HN-501	
	10.05 ~ 11.12	HN-579			HN-501	
GP6, GP7 2.0i, 2.0iS INCL. Eye Sight	11.12 ~	HN-579			HN-501	
VAG WRX S4	14.08 ~	HN-499				
2500 GRF, GVF WRX Sti A-Line, EXCL. BREMBO	09.02 ~	HN-499				
	9. 2 ~	HN-499		HN-611		
	08 ~				FN-7757 or NA	
IMPREZA ANESIS						
1500 GE2, GE3	8.10 ~ 11.09	HN-493				
GE2, GE3 1.5i-L	10.04 ~ 11.12					
2000 GE6, GE7	08.10 ~ 10.05	HN-460		HN-501		
	10.05 ~ 11.12	HN-579		HN-501		
IMPREZA G4						
1600 GJ2, GJ3	11.12 ~	HN-579		HN-501		
2000 GJ6, GJ7 2.0i, 2.0iS, INCL. Eye Sight	11.12 ~	HN-579		HN-501		
JUSTY						
KA5, KA6, KA7, KA8	84.02 ~ 94.04				FN-7728	
LEGACY						
2000 BMG B4 2.0GT, W/TURBO	12.05 ~ 14.10	HN-499				
2500 BM9 ~013006	09.05 ~ 10.05	HN-460		HN-501		
013007~	10.05 ~ 12.05	HN-579		HN-501		
2.5i S Package 013012~	10.05 ~ 12.05	HN-499				
TURBO	09.05 ~ 12.05	HN-499				
B4 2.5GT EyeSight W/TURBO	12.05 ~ 14.10	HN-499				
BR9 ~030001	09.05 ~ 10.05	HN-460		HN-501		
030002~	10.05 ~ 14.06	HN-579		HN-501		
2.5i S Package 030013~	10.05 ~ 14.06	HN-499				
TURBO	09.05 ~ 14.06	HN-499				
LEGACY B4						
2000 BMG	12. 5 ~ 14. 1	HN-499		HN-611		
2500 BM9, BMM	9. 5 ~ 14. 1	HN-499		HN-611		

Model 車種形式		Year 年式	Front フロント		Rear リア		Parking パーキング
			Pad パッド	Shoe シュー	Pad パッド	Shoe シュー	Shoe シュー
LEGACY Touring wagon							
2000 BRG	2.0GT DIT Turbo	12. 5 ~	HN-499		HN-611		
2500 BR9, BRM	Turbo	9. 6 ~ 14.10	HN-499		HN-611		
3600 BRF	OUTBACK	9. 5 ~ 14.10	HN-499		HN-611		
LEVORG							
1600 VM4	1.6GT	14.06 ~	HN-499		HN-501		
	1.6GT EyeSight 1.6GTS EyeSight	14.06 ~	HN-499				
2000 VMG	2.0GT EyeSight 2.0GTS EyeSight	14.06 ~	HN-499				
LUCRA							
660 L455F	Excl. Turbo	12.04 ~ 14.09	HN-428			FN-2397	
	RS Turbo	12.04 ~ 14.09	HN-492			FN-2397	
PLEO							
660 L275B	Van	10. 4 ~ 13.02	HN-428			FN-0027	
	Van 5MT	13. 2 ~	HN-428			FN-2397	
	Van CVT	13. 2 ~	HN-492			FN-2397	
L275F	RS CUSTOM 12 inch	10. 4 ~ 13.02	HN-428			FN-0027	
	RS CUSTOM 12 inch	13. 2 ~	HN-428			FN-2397	
	L LTD 13 inch	13. 2 ~	HN-492			FN-2397	
L285B	Van 12 inch	10. 4 ~ 13.02	HN-428			FN-0027	
L285B	Van 4WD CVT, 13 inch	13. 2 ~	HN-492			FN-0043	
L285F		10. 4 ~	HN-428			FN-0043	
REX COMBI							
	KM2	81.08 ~ 86.10				FN-7728	
PLEO+							
660 LA300F	2WD	12.12 ~	HN-428			FN-0044	
	LA310F 4WD	12.12 ~	HN-428			FN-0043	
SAMBAR							
660 S201J, S211J, S201H, S211H, S321B, S331B		12.04 ~ 14.09	HN-512			FN-0038	
	S500J, S510J	14.09 ~	HN-512			FN-0038	
	S321B Without ABS	14. 5 ~	HN-512			FN-0038	
	With ABS	14. 5 ~	HN-512			FN-0041	
	S321Q Without ABS	14. 5 ~	HN-512			FN-0038	
	With ABS	14. 5 ~	HN-512			FN-0041	
	S331B Without ABS	14. 5 ~	HN-512			FN-0038	
	With ABS	14. 5 ~	HN-512			FN-0041	
	S331Q Without ABS	14. 5 ~	HN-512			FN-0038	
	With ABS	14. 5 ~	HN-512			FN-0041	
STELLA							
660 LA100F		11. 4 ~ 11. 8	HN-428			FN-0042	
	Excl. RS	11. 8 ~ 12.12	HN-428			FN-0042	
	RS	11. 8 ~ 12.12	HN-492			FN-0042	
		13. 1 ~ 14.12	HN-492			FN-2392	
	LA110F 4WD	11. 4 ~ 11.08	HN-428			FN-0043	

Model 車種形式	Year 年式	Front フロント		Rear リア		Parking パーキング
		Pad パッド	Shoe シュー	Pad パッド	Shoe シュー	Shoe シュー
STELLA						
LA110F	4WD Excl. RS		11. 8 ~ 12.12	HN-428		FN-0043
	4WD RS		11. 8 ~ 12.12	HN-492		FN-0043
			13. 1 ~ 14.12	HN-492		FN-0043
SUBARU XV						
1500 GH2	1.5i 1.5i-L 040805-040806		10. 6 ~ 11.10	HN-460		HN-501
	1.5i 1.5i-L 040810~		10. 6 ~ 11.10	HN-579		HN-501
GH3	1.5i 1.5i-L 017902~		10. 6 ~ 11.10	HN-579		HN-501
2000 GH6	2.0i 2.0i-S 003301-003302		10. 6 ~ 11.10	HN-460		HN-501
	2.0i 2.0i-S 003305~		10. 6 ~ 11.10	HN-579		HN-501
GH7	10401		10. 6 ~ 11.10	HN-460		HN-501
	10402~		10. 6 ~ 11.10	HN-579		HN-501
GP7	4WD		12.10 ~	HN-579		HN-501
GPE	4WD Hybrid		13. 3 ~	HN-579		HN-501
SUZUKI						
800, SS80, ALTO, MARUTI ALTO, A-STAR, CELERIO						
AMF310				HN-443 or NA		FN-9992
ALTO						
SS41V			83.10 ~ 84. 9		FN-9910	FN-9910
660 HA25S, HA25V			09.12 ~ 14.12	HN-566		FN-9967 or 9999
HA35S	eco ~No.140000		11.12 ~ 14.12	HN-566		FN-9967
	No.140001~		11.12 ~ 14.12	HN-566		
HA36S	Turbo RS		15. 3 ~	HN-443		FN-9999
	Excl. Turbo RS		14.12 ~	HN-582		FN-9999
HA36V	Van		14.12 ~	HN-582		FN-9999
ALTO LAPIN						
660 HE33S			15. 6 ~	HN-582		
APV						
GC415T, GC416T				HN-957		FN-9980
GC415V, GC416V				HN-957		FN-9980
APV ARENA						
1500 SGX-M/SGX-AT			07.10 ~	HN-957		
1600 SGX-AT			07.10 ~	HN-957		
CARRY						
ST30, ST31, ST40, ST41			79. 5 ~ 85. 3		FN-9904	FN-9904
ST31, ST41 4WD			81. 9 ~ 85. 3		FN-9910	FN-9910
ST90K, ST90V			81 ~		FN-9910	FN-9910
660 DA16T	EXCL. SPECIALLY-EQUIPPED VEHICLE		13. 9 ~	HN-566		FN-9966
	SPECIALLY-EQUIPPED VEHICLE, MOTORCYCLE CARRIER CAR		13.10 ~	HN-566		FN-9966
	DUMP, GATE LIFTER, A REFRIGERATOR VEHICLE		13.10 ~	HN-566		FN-5524

New Products

CAR MODEL

Model 車種形式	Year 年式	Front フロント		Rear リア		Parking パーキング
		Pad パッド	Shoe シュー	Pad パッド	Shoe シュー	Shoe シュー
Carry, Super carry						
GC415T, GC416T		HN-957			FN-9980	
GC415V, GC416V		HN-957			FN-9980	
ESCUDE						
1600 TA74W	06.06 ~	HN-980			FN-9970	
TD54W, TD94W	05.04 ~	HN-980			FN-9970	
CBA-TA74W	06.06 ~	HN-980		HN-466		
2000 TD54	05.05 ~	HN-980			FN-9970	
CBA-TD54W	05.06 ~ 08.05	HN-980		HN-466		
2400 CBA-TDA4W	08.06 ~	HN-980		HN-466		
2700 CBA-TD84W	05.05 ~	HN-980		HN-466		
TD94W	05.05 ~	HN-980			FN-9970	
3200 TDB4W, CBA-TDB4W	08.06 ~	HN-980		HN-466		
GRAND VITARA						
1600 JT	09.01 ~	HN-980		HN-466		
2000 JT COMPACT SUV	05.10 ~ 08.06	HN-980		HN-466		
2400 JT COMPACT SUV	09.01 ~	HN-980		HN-466		
3200 JT COMPACT SUV	09.01 ~	HN-980		HN-466		
GRAND VITARA XL-7						
JA420WD-4, JA627W, JA627W-2		HN-382 or N/A			FN-9968	
GRAND VITARA, GRAND VITARA X						
JB416X, JB416X-2, JB416X-4, JB419XD, JB419XD2, JB419XD-3, JB419XD-4, JB420W, JB420W-2, JB424X-4, JB627W, JB627W-2, JB627W-3		HN-980 or N/A		FN-9970 or HN-565		
JB419WD, JB419WD-2, JB419WD-3, JB420W, JB420W-2, JB627W, JB627W-2, JB627W-3		HN-980 or N/A			FN-9970	
JB419WD-4, JB420W-4, JB424W-4, JB632W-4, JB424W, JB632W, JB632W-4		HN-980 or N/A		HN-565		
SQ416L, SQ416Q, SQ416V, SQ416X, SQ420L, SQ420Q, SQ420V, SQ420X, SQ625L, SQ420XD, SQ420W, SQ420WD, SQ625, SQ625W		HN-301, HN-382			FN-9958	
HUSTLER						
660 MR31S	14. 1 ~	HN-566			FN-9999	
MR41S	15. 5 ~	HN-566			FN-9999	
IGNIS						
1200 FF21S	16. 2 ~	HN-443				

New Products

CAR MODEL

Model 車種形式	Year 年式	Front フロント		Rear リア		Parking パーキング
		Pad パッド	Shoe シュー	Pad パッド	Shoe シュー	Shoe シュー
JIMNY						
SJ30, SJ40, SJ410	81. 5 ~		FN-9910		FN-9910	
LANDY						
2000 SC25 ~No. 690963	07. 1 ~ 10.12	HN-517		HN-466		
No. 690963~	07. 1 ~ 10.12	HN-517		HN-565		
SNC25 ~No. 690188	07. 1 ~ 10.12	HN-517		HN-466		
No. 690189~	07. 1 ~ 10.12	HN-517		HN-565		
SHC26	12. 8 ~	HN-517		HN-565		
LAPAN						
660 HE22S	13.06 ~ 15.06				FN-9999	
HE33S	15.05 ~				FN-9999	
LIANA						
1300 RB21S	01.07 ~ 07.12	HN-948			FN-0032	
RH413	01.03 ~ 07.12	HN-948			FN-0032	
1500 RB21S	01.07 ~ 07.12	HN-948			FN-0032	
1600 RB21S, RH416	01.07 ~ 07.12	HN-948			FN-0032	
SOLIO						
1200 MA15S	10.12 ~ 15. 7	HN-529				
BANDIT	12.06 ~ 15. 7	HN-529				
MA26S, MA36S	15. 8 ~	HN-443				
SPACIA						
660 MK32S	13.02 ~	HN-566			FN-9999	
MK42S	15.05 ~	HN-566			FN-9999	
SPLASH						
1000 5DR HATCHBACK	08.10 ~ 11.02	HN-959			FN-2386	
1200 DBA-XB32S	08.10 ~	HN-959			FN-2386	
1300 DBA-XB32S 5DR HATCHBACK	08.10 ~	HN-959			FN-2386	
SWIFT						
1600 ZC32S SPORTS	11.12 ~	HN-562		HN-581		
SWIFT(EURO)						
1300 MZ, SG	05.01 ~ 09.06	HN-959				
1500 MZ, SG	05.01 ~ 09.06	HN-959				
SWIFT III(SG)						
1300 SG HATCHBACK	01.06 ~	WHN-959			FN-2386	
SWIFT, FORSA						
AZG412, AZG413D, AZG416	09 ~	HN-562 or N/A			FN-9991 or N/A	
AZH412, AZH414, AZH416	09 ~	HN-562, HN-529 or N/A			FN-9991 or N/A	

Model 車種形式	Year 年式	Front フロント		Rear リア		Parking パーキング
		Pad パッド	Shoe シュー	Pad パッド	Shoe シュー	Shoe シュー
SX4						
RW415, RW415-3, RW416, RW416-2, RW416-3, RW415-2, RW416D, RW419D, RW420D, RW415-4, RW416-4, RW416-5, RW420		HN-504 or others		FN-9996, FN-9983 or HN-397		
WAGON R						
660 MH34S	12.09 ~ 17.02	HN-566			FN-9999	
MH44S	15.05 ~ 17.02	HN-566			FN-9999	
MH35S, MH55S	17.12 ~				FN-9999	
DAIHATSU						
ATRAI WAGON						
660 S320G, S330G	05.11 ~ 07. 7	HN-512			FN-0038	
HIJET ・ ATRAI						
S220V, S230V	98.12 ~ 00. 5	HN-438			FN-0029	
	00. 5 ~ 01.12	HN-438			FN-0038	
TURBO	98.12 ~ 00. 1	HN-341			FN-0029	
660 S500P, S510P	14. 9 ~	HN-512			FN-0038	
S321W,V,S331W,V W/O ABS	14. 5 ~	HN-512			FN-0038	
W ABS	14. 5 ~	HN-512			FN-0041	
S320V	7. 8 ~	HN-512			FN-0038	
MEBIUS						
2000 ZVW41N	13. 4 ~	HN-524		HN-569		
MIRA						
660 L275V	12 inch disc	13. 2 ~	HN-428		FN-2397	
	13 inch disc	13. 2 ~	HN-428		FN-2397	
L285V		13. 2 ~	HN-492		FN-0043	
L275S		13. 2 ~	HN-428		FN-2397	
MIRA COCOA						
660 L675S		14. 8 ~	HN-492		FN-2397	
L685S		14. 8 ~	HN-492		FN-0043	
MIRA e:s						
660 LA300S		11. 8 ~			FN-0044	
MOVE						
660 L160S	W/O TURBO	05. 8 ~ 06.10	HN-428		FN-0030	
TANTO						
660 L375S		12. 5 ~ 13. 9	HN-492		FN-2397	
LA600S		13.10 ~ 15. 5			FN-2397	
LA610S	4WD	13.10 ~ 15. 5			FN-0043	

New Products Brake Shoe-Cross Reference

Original Parts No.	Mfg. No.
NISSAN	
44060-8J00K	FN-1901
44060-0F027	FN-1225
44060-21G25	FN-1162
44060-37G25	FN-1189
44060-4Z025	FN-1247
44060-8H725	FN-1903
44060-8M125	FN-1247
44060-8M126	FN-1247
44060-AR025	FN-1901
44060-AX625	FN-1255
44060-CY025	FN-1299
44060-EA025	FN-1902
44060-EA026	FN-1902
44060-VE426	FN-1174
46540-42010	FN-1299
46540-42020	FN-1299
AY360-NS104	FN-1276
AY360-NS107	FN-1280
AY360-NS108	FN-1276
AY360-NS112	FN-1280
AY360-NS113	FN-1276
AY360-NS114	FN-1280
D4060-1HA3B	FN-1280
D4060-1HA3D	FN-1280
D4060-1HJ2D	FN-1280
D4060-1HJ2E	FN-1280
D4060-28N25	FN-1174
D4060-2S425	FN-1174
D4060-8H725	FN-1903
D4060-8M126	FN-1247
D4060-AX600	FN-1255
D4060-JX00A	FN-1276
D4060-JX01A	FN-1276
D4060-JX02A	FN-1276
D4060-WE90A	FN-1170
D40FOAR06K	FN-1901
MQ704263	FN-1276
MQ710678	FN-1276
44060-80W25	FN-1175
D4060-1HD3E	FN-1286
1606631180	FN-1286
7701206429	FN-1286
7701207178	FN-1286
D40601HD3A	FN-1286
D40601HD3B	FN-1286
D40601HD3C	FN-1286
D40601HD3D	FN-1286
44060-95FOA	FN-1279

Original Parts No.	Mfg. No.
TOYOTA	
04495-33070	FN-2404
04494-37021	FN-2801R
04494-60030	FN-2255
04495-02110	FN-2354
04495-05010	FN-2354
04495-05020	FN-2347
04495-05030	FN-2347
04495-0D060	FN-2383
04495-0K070	FN-2395
04495-0K120	FN-2395
04495-37032	FN-2802R
04495-42050	FN-2404
04495-42080	FN-2404
04495-74010	FN-2401
04495-74020	FN-2401
04495-74030	FN-2401
04495-8Z010	FN-2367
46540-20040	FN-2901
46540-60060	FN-2904
46550-60070	FN-2904
46580-60060	FN-2904
46590-33020	FN-2901
04495-0K040	FN-2411
04495-0K110	FN-2411
04495-35250	FN-2803
04495-35220	FN-2803
04495-52121	FN-2423

Original Parts No.	Mfg. No.
ISUZU	
8-973026351	FN-4470
5-47110-058-2	FN-4442
5-87832-090-0	FN-4467
8-97113-219-1	FN-4462
8-973519211	FN-4467
8-973682530	FN-4470
8-973682540	FN-4467
8-97947802-0	FN-6741
8-980180360	FN-4467

New Products Brake Shoe-Cross Reference

Original Parts No.	Mfg. No.
mitsubishi	
4600A018	FN-6741
4600A106	FN-6741
4600A122	FN-6741
4600A198	FN-6715
4800A089	FN-6729
MB238520	FN-6664
MB618915	FN-6901
MB618916	FN-6901
MB858665	FN-6712
MB950211	FN-6704
MC889515	FN-6722R
MK326854	FN-6722
MK501612	FN-6722R
MK530539	FN-6680
MN102645	FN-6904
MN150861	FN-6904
MN186303	FN-6704
MR129852	FN-6704
MR178827	FN-6901
4600A350	FN-6744

Original Parts No.	Mfg. No.
DAIHATSU	
04495-B1080	FN-0042
04495-B2010	FN-0027
04495-B2210	FN-0043

Original Parts No.	Mfg. No.
MAZDA	
D6Y1-26-38Z	FN-3434
1823-26-310B	FN-3326
B4Y5-26-38Z	FN-3373
BSY6-26-38Z	FN-3373
DFY1-26-38Z	FN-3431
DFY1-26-38ZA	FN-3431
ECY12638ZB	FN-3382
GEYT2638ZC	FN-3399
UAYN-26-38Z	FN-3413
UB39-26-310	FN-3357
UHY1-26-38Z	FN-3413
UHY4-26-38Z	FN-3416
UJY6-26-38Z	FN-3413
UJY8-26-38Z	FN-3416
URY1-26-38Z	FN-3416
URY2-26-38Z	FN-3416
26694-FG000	FN-7757
04495-B2270	FN-0044
04495-B2271	FN-0044

New Products Brake Pad-Cross Reference

Genuine Parts No.	JFBK Parts No.
NISSAN	
41060-17U90	HN-954
41060-1E090	HN-954
41060-2F525	HN-950
41060-2F526	HN-950
41060-2F527	HN-950
41060-2X825	HN-922
41060-38U90	HN-954
41060-38UX0	HN-954
41060-5M325	HN-950
41060-5M326	HN-950
41060-7S025	HN-961
41060-7S026	HN-961
41060-7S027	HN-961
41060-7Z025	HN-701
41060-7Z026	HN-701
41060-89E92	HN-954
41060-9C125	HN-922
41060-9C525	HN-922
41060-9C526	HN-922
41060-AX601	HN-959
41060-AX625	HN-959
41060-BM525	HN-950
41060-CA090	HN-958
41060-CA091	HN-958
41060-CA092	HN-958
41060-CA093	HN-958
41060-CG00J	HN-958
41060-CG090	HN-958
41060-CG091	HN-958
41060-VK190	HN-701
41060-ZA525	HN-958
41060-ZC025	HN-961
41060-ZC026	HN-961
41060-ZC027	HN-961
44060-7S025	HN-920
44060-EA085	HN-962
44060-EA090	HN-962
44060-EA091	HN-962
44060-EB325	HN-962
44060-VC290	HN-955
44060-ZC025	HN-920
44060-ZC026	HN-920
AY040-NS121	HN-958
AY040-NS935	HN-958
D10601AA0A	HN-958
D10601HA0A	HN-959
D10601HA0B	HN-959
D1060-1LB2A	HN-973
D1060AX60A	HN-959
D1060AX61A	HN-959
D1060AX61F	HN-959
D1060-BM50A	HN-950

Genuine Parts No.	JFBK Parts No.
D1060-JK000	HN-936
D1060-JK00B	HN-936
D1060-VK190	HN-701
D1M601AA0K	HN-958
D4060-9FE0A	HN-920
D4060-VC290	HN-955
N1010-132644	HN-958
AY040-NS150	HN-610
D1060-1JA0A	HN-610
D1060-4BA0A	HN-620
D4060-1LB8E	HN-979
D4060-1LBOA	HN-979
D1060-3TA0A	HN-975
D1060-3TA0B	HN-975
TOYOTA	
04465-02010	HN-710
04465-02030	HN-972
04465-02040	HN-952
04465-02050	HN-952
04465-02061	HN-951
04465-02100	HN-951
04465-02130	HN-951
04465-02150	HN-951
04465-02160	HN-713
04465-02170	HN-713
04465-02190	HN-933
04465-02200	HN-713
04465-02210	HN-713
04465-02270	HN-713
04465-02280	HN-933
04465-02330	HN-713
04465-02370	HN-713
04465-04010	HN-710
04465-04030	HN-710
04465-04050	HN-710
04465-04060	HN-710
04465-05020	HN-930
04465-05030	HN-930
04465-05040	HN-930
04465-05042	HN-930
04465-05060	HN-930
04465-05110	HN-930
04465-05130	HN-964
04465-0D050	HN-976
04465-0D120	HN-976

Genuine Parts No.	JFBK Parts No.
04465-05131	HN-964
04465-05140	HN-964
04465-05150	HN-964
04465-05170	HN-964
04465-05210	HN-964
04465-05220	HN-964
04465-05221	HN-964
04465-05270	HN-964
04465-05280	HN-964
04465-05281	HN-964
04465-06090	HN-970
04465-0D040	HN-703
04465-0D160	HN-969
04465-0F010	HN-933
04465-0J140	HN-710
04465-0K010	HN-709
04465-0K020	HN-710
04465-0K040	HN-834
04465-0K070	HN-710
04465-0K100	HN-834
04465-0K110	HN-834
04465-0K130	HN-834
04465-0K140	HN-710
04465-0K141	HN-710
04465-0K160	HN-709
04465-0K240	HN-790
04465-0K260	HN-790
04465-0K290	HN-968
04465-0K300	HN-790
04465-0K310	HN-834
04465-0K330	HN-790
04465-0K340	HN-790
04465-0W110	HN-928
04465-0W130	HN-928
04465-12520	HN-952
04465-47060	HN-567
04465-47070	HN-567
04465-50260	HN-928
04465-53020	HN-912
04465-BZ010	HN-957
04465-YZZE4	HN-710
04465-YZZEB	HN-964
04466-02020	HN-929
04466-02040	HN-929
04466-02070	HN-929
04466-02110	HN-929
04466-02160	HN-929
04466-02170	HN-904
04466-02180	HN-904
04466-02181	HN-904
04466-05040	HN-935
04466-05041	HN-935
04466-0W010	HN-945



DISC BRAKE PADS & BRAKE SHOE ASSY

CAR MODEL

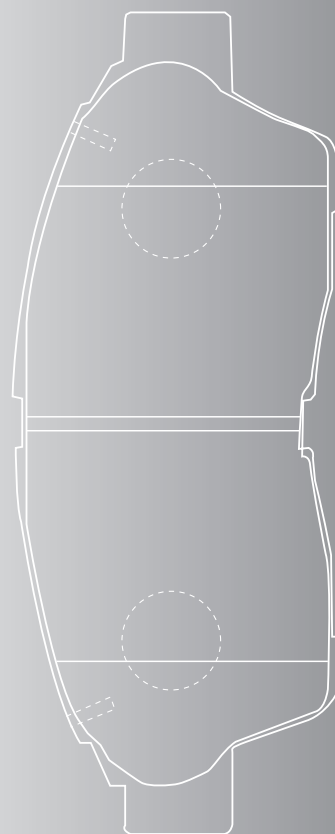

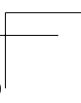
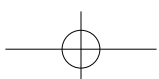
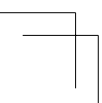
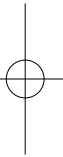
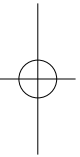
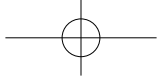
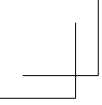

NISSAN - 1

Model 車種形式	Year 年式	Front フロント		Rear リア		Parking パーキング
		Pad パッド	Shoe シュー	Pad パッド	Shoe シュー	Shoe シュー
180SX						
1800 RS13	89.3 ~ 91.1	HN-367		HN-377		
2000 RPS13, KRPS13 Turbo	91.1 ~ 99.1	HN-201A		HN-377		
AD・AD EXPERT						
1200 VAY12	06.12 ~	HN-452			FN-1264	
1500 VY12	06.12 ~	HN-452			FN-1264	
1600 VZNY12	08.12 ~	HN-452			FN-1264	
1800 VJY12	06.12 ~	HN-452			FN-1264	
AD VAN						
1300 VY10	90.10 ~ 97.5	HN-375			FN-1185	
	W/O ABS 97.5 ~ 99.6	HN-225			FN-1185	
	W/ ABS 97.5 ~ 99.6	HN-225			FN-1185	
WY10	90.10 ~ 95.6	HN-375			FN-1185	
MVY10 MEXICO ORIGIN	93.7 ~ 99.6	HN-375			FN-1185	
VY11	W/O ABS 99.6 ~ 07.1	HN-435			FN-1170	
	DX W/ ABS 99.6 ~ 07.1	HN-435			FN-1198	
1500 VFY10	90.10 ~ 97.5	HN-375			FN-1185	
	97.5 ~ 99.6	HN-225			FN-1185	
	W/ ABS 94.8 ~ 99.6	HN-225			FN-1198	
VFGY10	92.4 ~ 97.5	HN-375			FN-1170	
	97.5 ~ 99.6	HN-225			FN-1170	
	W/ ABS 94.8 ~ 99.6	HN-225			FN-1198	
WFY10	W/O ABS 90.10 ~ 96.5	HN-375			FN-1185	
	W/ ABS 94.8 ~ 96.5	HN-225			FN-1198	
WFGY10	92.4 ~ 96.5	HN-375			FN-1170	
	96.5 ~ 99.6	HN-356			FN-1170	
	WITH ABS 94.8 ~ 99.6	HN-225			FN-1198	
VFNY10	90.10 ~ 99.6	HN-225			FN-1170	
WFNY10	W/O ABS 90.10 ~ 96.5	HN-225			FN-1170	
	W/ ABS 94.8 ~ 96.5	HN-225			FN-1198	
MVFY10 MEXICO ORIGIN	93.7 ~ 99.6	HN-375			FN-1185	
VFY11	W/O ABS 99.6 ~ 07.1	HN-435			FN-1170	
	W/ ABS 99.6 ~ 07.1	HN-435			FN-1198	
1700 VSY10	93.8 ~ 97.5	HN-375			FN-1170	
	WITH ABS 94.8 ~ 97.5	HN-225			FN-1198	
VSGY10	92.4 ~ 97.5	HN-375			FN-1170	
	WITH ABS 94.8 ~ 97.5	HN-225			FN-1198	
VSNY10	90.10 ~ 97.5	HN-225			FN-1170	
1800 VHNY11	99.6 ~ 07.1	HN-435			FN-1170	
VGY11	W/O ABS 00.1 ~ 07.1	HN-435			FN-1170	
	W/ ABS 00.1 ~ 07.1	HN-435			FN-1198	

- NISSAN
- TOYOTA (HINO)
- MAZDA
- ISUZU
- HONDA
- MITSUBISHI
- SUBARU
- SUZUKI
- DAIHATSU
- LEXUS
- INFINITI
- HYUNDAI
- KIA

NISSAN - 2

NISSAN

TOYOTA
(HINO)

MAZDA

ISUZU

HONDA

MITSUBISHI

SUBARU

SUZUKI

DAIHATSU

LEXUS

INFINITI

HYUNDAI

KIA

Model 車種形式	Year 年式	Front フロント		Rear リア		Parking パーキング
		Pad パッド	Shoe シュー	Pad パッド	Shoe シュー	Shoe シュー
AD VAN						
2000 WEY10	93. 8 ~ 96. 5	HN-375			FN-1185	
	W/ ABS 94. 8 ~ 96. 5	HN-225			FN-1198	
2200 VEY11	99. 6 ~ 07. 1	HN-435			FN-1170	
	W/ ABS 99. 6 ~ 07. 1	HN-435			FN-1198	
VENY11	99. 6 ~ 07. 1	HN-435			FN-1170	
GT-R						
3800 R35	07.12 ~					
NV200 VANETTE						
1600 M20, VM20	09. 5 ~	HN-556			FN-1276	
COUPE						
1500 FB13	91. 1 ~ 93.12	HN-226		HN-283	FN-1185	
1600 EB13	90. 1 ~ 93.12	HN-226		HN-283	FN-1185	
1800 HB13	W/O ABS 90. 1 ~ 93.12	HN-225		HN-283		
	W/ ABS 90. 1 ~ 93.12	HN-199		HN-283		
S-RV						
1500 FN15	W/O ABS 96. 5 ~ 00. 8	HN-356			FN-1185	
	W/ ABS 96. 5 ~ 00. 8	HN-356		HN357		
FNN15	W/O ABS 96. 5 ~ 00. 8	HN-356			FN-1170	
	W/ ABS 96. 5 ~ 00. 8	HN-356		HN-283		
1600 JN15 VZ-R	97. 9 ~ 00. 8	HN-268		HN-224		
1800 HNN15	96. 5 ~ 99. 4	HN-268		HN-224		
ATLAS						
1600 KUF22	SINGLE TYRE 90. 7 ~ 92. 1	HN-105			FN-1162	
UF22	SINGLE TYRE 90. 7 ~ 92. 1	HN-105			FN-1162	
UF22W	DOUBLE TYRES 90. 7 ~ 92. 1	HN-105			FN-1163	
UGF22W	DOUBLE TYRES 90. 7 ~ 91. 1	HN-105			FN-1163	
SJ2F23	SINGLE TYRE 92. 1 ~ 95. 6	HN-105			FN-1210	
	DOUBLE TYRES 92. 1 ~ 95. 6	HN-105			FN-1163	
2000 WF22, WGF22	1.5t SINGLE TYRE 90. 7 ~ 92. 1	HN-204			FN-1146A	
	1.5t DOUBLE TYRES 90. 7 ~ 92. 1	HN-204			FN-1163	
SK2F23	1.5t DOUBLE TYRES 92. 1 ~ 97. 8	HN-204			FN-1163	
	1.5t DOUBLE TYRES 97. 8 ~ 99. 6	HN-446			FN-1163	
	1t SINGLE TYRE 95. 6 ~ 99. 6	HN-105			FN-1210	
	1.25t SINGLE TYRE 95. 6 ~ 99. 6	HN-137			FN-1210	
	1.25t DOUBLE TYRES 95. 6 ~ 99. 6	HN-137			FN-1163	
SK4F23	1.5t SINGLE TYRE 92. 1 ~ 95. 6	HN-204			FN-1208	
	SUPERLOW 1.5t SINGLE TYRE 95. 6 ~ 97. 8	HN-204			FN-1208	
	SUPERLOW 1.5t SINGLE TYRE 97. 8 ~ 99. 6	HN-446			FN-1208	

NISSAN - 3

Model 車種形式			Year 年式	Front フロント		Rear リア		Parking パーキング
				Pad パッド	Shoe シュー	Pad パッド	Shoe シュー	Shoe シュー
ALTAS								
2000	SK4F23	1.5t	DOUBLE TYRES	95. 6 ~ 97. 8	HN-204			FN-1163
		1.5t	DOUBLE TYRES	97. 8 ~ 99. 6	HN-446			FN-1163
	SH2F23	AT	SINGLE TYRE	99. 6 ~ 07. 6	HN-137			FN-1210
		AT	DOUBLE TYRES	99. 6 ~ 07. 6	HN-137			FN-1163
	SH4F23	MT	SINGLE TYRE	99. 6 ~ 07. 6	HN-446			FN-1210
		MT	DOUBLE TYRES	99. 6 ~ 07. 6	HN-446			FN-1163
	SQ1F24	AT		99. 6 ~ 07. 6	HN-446			FN-1163
		MT		99. 6 ~ 07. 8	HN-446			FN-1208
	SQ2F24	SUPER LOW		07. 6 ~	HN-475			FN-6655
		FULL SUPER LOW		07. 6 ~	HN-475			FN-1208
	SM2F23	SUPER LOW		07. 6 ~	HN-475			FN-6655
		FULL SUPER LOW		07. 6 ~	HN-475			FN-1208
2300	SM4F23	1t	SINGLE TYRE	92. 1 ~ 95. 6	HN-105			FN-1210
		1t	DOUBLE TYRES	92. 1 ~ 95. 6	HN-105			FN-1163
	SM6F23	1t	DOUBLE TYRES	92. 1 ~ 95. 6	HN-105			FN-1163
		1t	DOUBLE TYRES	92.10 ~ 95. 6	HN-137			FN-1210
	TF22		SINGLE TYRE	88.10 ~ 92. 1	HN-105			FN-1162
			DOUBLE TYRES	88.10 ~ 92. 1	HN-105			FN-1163
	TGF22W		DOUBLE TYRES	88.10 ~ 92. 1	HN-105			FN-1163
			DOUBLE TYRES	88.10 ~ 92. 1	HN-105			FN-1163
2500	SN2F23	0.85t	SINGLE TYRE	97. 8 ~ 99. 6	HN-137			FN-1210
		0.85t	DOUBLE TYRES	97. 8 ~ 99. 6	HN-137			FN-1163
	SN4F23	1t	SINGLE TYRE	95. 6 ~ 99. 6	HN-105			FN-1210
		1t	SMALL RADIOUS DOUBLE TYRES	95. 6 ~ 99. 6	HN-105			FN-1163
	SN6F23	1.25t DOUBLE CABIN		95. 6 ~ 99. 6	HN-137			FN-1163
		1.25t	SINGLE TYRE	97. 8 ~ 99. 6	HN-137			FN-1210
	SN6F23	1.25t	SMALL RADIOUS DOUBLE TYRES	97. 8 ~ 99. 6	HN-137			FN-1163
		1.25t		95. 6 ~ 99. 6	HN-137			FN-1163
	SN6F23	1.5t		95. 6 ~ 97. 8	HN-204			FN-1163
		1.5t		97. 8 ~ 99. 6	HN-446			FN-1163
	SN6F23			95. 6 ~ 99. 6	HN-137			FN-1210
				95. 6 ~ 99. 6	HN-137			FN-1210
2700	AF22, AGF22	AT		88.10 ~ 92. 1	HN-105			FN-1163
		MT		88.10 ~ 92. 1	HN-204			FN-1146A
	VAGF22W		DOUBLE TYRES	88.10 ~ 92. 1	HN-204			FN-1163
			SINGLE TYRE	88.10 ~ 92. 1	HN-204			FN-1146A
	SP2F23	4WD 1.5t		88.10 ~ 92. 1	HN-204			FN-1146A
		AT		92. 1 ~ 95. 6	HN-105			FN-1163
	SP4F23	MT		95. 6 ~ 99. 6	HN-204			FN-1163
		MT	SINGLE TYRE	99. 6 ~ 04. 8	HN-137			FN-1210
	SP4F23	MT	DOUBLE TYRES	99. 6 ~ 04. 8	HN-137			FN-1163
		AT		92. 1 ~ 95. 6	HN-105			FN-1163
	SP4F23	MT	SINGLE TYRE	95. 6 ~ 99. 6	HN-204			FN-1208
		MT	DOUBLE TYRES	95. 6 ~ 99. 6	HN-204			FN-1163
	SP4F23	MT	SINGLE TYRES	99. 6 ~ 04. 8	HN-137			FN-1210
		MT	DOUBLE TYRES	99. 6 ~ 04. 8	HN-137			FN-1163
	SP6F23			99. 6 ~ 02. 8	HN-137			FN-1210
				02. 8 ~ 04. 8	HN-137			FN-1174
	SP8F23			92. 1 ~ 97. 8	HN-204			FN-1208

- NISSAN
- TOYOTA (HINO)
- MAZDA
- ISUZU
- HONDA
- MITSUBISHI
- SUBARU
- SUZUKI
- DAIHATSU
- LEXUS
- INFINITY
- HYUNDAI
- KIA

NISSAN - 4

- NISSAN
- TOYOTA
(HINO)
- MAZDA
- ISUZU
- HONDA
- MITSUBISHI
- SUBARU
- SUZUKI
- DAIHATSU
- LEXUS
- INFINITI
- HYUNDAI
- KIA

Model 車種形式	Year 年式	Front フロント		Rear リア		Parking パーキング
		Pad パッド	Shoe シュー	Pad パッド	Shoe シュー	Shoe シュー
ALTAS						
3000 SZ1F24	SUPER LOW		HN-475			FN-6655
	FULL SUPER LOW		HN-475			FN-1208
SZ2F24	SUPER LOW		HN-475			FN-6655
			HN-475			FN-1208
SZ4F24			HN-475			FN-1208
SZ5F24			HN-475			FN-1208
TZ2F24	SUPER LOW		HN-545			FN-2297
	FULL SUPER LOW		HN-545			FN-4451
TZ3F24	SUPER LOW		HN-545			FN-2297
	FULL SUPER LOW		HN-545			FN-4451
3200 SR2F23	1.5t	DOUBLE TYRES	97. 8 ~ 07. 6	HN-446		FN-1163
SR4F23	1.5t	DOUBLE TYRES	97. 8 ~ 07. 6	HN-446		FN-1163
	1.5t	SINGLE TYRES	97. 8 ~ 07. 6	HN-446		FN-1208
	1.25t	DOUBLE CABIN	97. 8 ~ 07. 6	HN-446		FN-1163
SR8F23			97. 8 ~ 07. 6	HN-446		FN-1208
ATLAS CONDOR						
2000 WH40		SINGLE TYRES	90. 6 ~ 91.10		FN-1161	FN-1161 FN-1135
WH40WH		HIGH FLOOR DOUBLE TYRES	90. 6 ~ 91.10		FN-1152	FN-1152 FN-1135
WH40WV		LOW-FLOOR, DOUBLE TYRES	90. 6 ~ 91.10		FN-1161	FN-4428 FN-1135
3000 JH40H		HIGH FLOOR SINGLE TYRES	89. 5 ~ 91.10		FN-1152	FN-1152 FN-1135
JH40L		LOW FLOOR SINGLE TYRE	89. 5 ~ 91.10		FN-1161	FN-1161 FN-1135
JGH40W		LOW FLAT FLOOR DOUBLE TYRES	89. 5 ~ 91.10		FN-1161	FN-4428 FN-1135
JH40WH		HIGH FLOOR DOUBLE TYRES	89. 5 ~ 91.10		FN-1152	FN-1152 FN-1135
JH40WT		HIGH FLOOR DOUBLE TYRES	89. 5 ~ 91.10		FN-1152	FN-1152 FN-1135
JH40WV		DOUBLE TYRES	89. 5 ~ 91.10		FN-1161	FN-4428 FN-1135
DJH40W	DUMP TRUCK	DOUBLE TYRES	89. 5 ~ 91.10		FN-1161	FN-4428 FN-1135
SW2H41		LOW FLAT FLOOR SINGLE TYRE	91.10 ~ 93.10		FN-1197	FN-1197 FN-3340
		LOW FLAT FLOOR SINGLE TYRE	93.10 ~ 95. 5		FN-1197	FN-1201 FN-3340
SW2S41		DOUBLE TYRES	91.10 ~ 95. 5	HN-368	FN-1197	FN-1201 FN-3340
		SMALL RADIOUS DOUBLE TYRES	91.10 ~ 95. 5		FN-1197	FN-1197 FN-3340
		SMALL RADIOUS DOUBLE TYRES	91.10 ~ 93.10	HN-368		FN-1202 FN-3340
		SMALL RADIOUS DOUBLE TYRES	93.10 ~ 95. 5	HN-368		FN-1201 FN-3340
		FLAT DOUBLE TYRES	92. 1 ~ 95. 5	HN-368	FN-1201	FN-1201 FN-3340
DW2H41		LOW FLAT FLOOR SINGLE TYRE	91.10 ~ 93.10	HN-368	FN-1197	FN-1197 FN-3340
		LOW FLAT FLOOR SINGLE TYRE	93.10 ~ 95. 5	HN-368	FN-1197	FN-1201 FN-3340
DW2S41		DOUBLE TYRES	91.10 ~ 95. 5	HN-368	FN-1201	FN-1201 FN-3340
		SMALL RADIOUS DOUBLE TYRES	91.10 ~ 95. 5		FN-1201	FN-1197 FN-3340
		SMALL RADIOUS DOUBLE TYRES	91.10 ~ 93.10	HN-368		FN-1202 FN-3340
		SMALL RADIOUS DOUBLE TYRES	93.10 ~ 95. 5	HN-368		FN-1201 FN-3340
		FLAT DOUBLE TYRES	92. 1 ~ 95. 5	HN-368		FN-1201 FN-3340
LW4YH41		SMALL RADIOUS DOUBLE TYRES	91.10 ~ 93.10	HN-368		FN-1202 FN-3340
		SMALL RADIOUS DOUBLE TYRES	93.10 ~ 95. 5	HN-368		FN-1201 FN-3340
LW4YS41		FLAT DOUBLE TYRES	92. 1 ~ 95. 5	HN-368		FN-1201 FN-3340
3100 AKR69E	DUMP TRUCK		95. 6 ~ 99. 4	HN-288		FN-4428 FN-4443
			95. 6 ~ 99. 4	HN-384		FN-4458 FN-4443

NISSAN - 5

Model 車種形式	Year 年式	Front フロント		Rear リア		Parking パーキング
		Pad パッド	Shoe シュー	Pad パッド	Shoe シュー	Shoe シュー
ATLAS CONDOR						
3100 AKR69L	95. 6 ~ 99. 4	HN-384				FN-4451 FN-4443
BKR69E DUMP TRUCK	95. 6 ~ 99. 4	HN-288				FN-4428 FN-4443
	95. 6 ~ 99. 4	HN-384				FN-4458 FN-4443
BKR69L	95. 6 ~ 99. 4	HN-384				FN-4451 FN-4443
AHR69K 1.5t DOUBLE TYRES	99. 2 ~ 99. 6	HN-289				FN-4428 FN-4404
1.5t DOUBLE TYRES	99. 7 ~ 02. 6	HN-289				FN-4404
3500 SH40, SGH40 HIGH-FLOOR	86.11 ~ 91.10		FN-1152			FN-1152 FN-8802
LOW FLAT FLOOR	86.11 ~ 91.10		FN-1161			FN-4428 FN-8802
CSH40	89. 5 ~ 91.10		FN-1183			FN-1183 FN-8802
DSH40 DUMP TRUCK HIGH FLOOR DOUBLE TYRES	89. 5 ~ 91.10		FN-1152			FN-1152 FN-8802
LOW FLOOR DOUBLE TYRES	89. 5 ~ 91.10		FN-1161			FN-4428 FN-8802
SQH40	89. 5 ~ 91.10		FN-1183			FN-1183 FN-8802
SE2H41 2t LOW FLAT FLOOR DOUBLE TYRES	91.10 ~ 95. 5	HN-368				FN-1201 FN-3340
SE2S41 HIGH FLOOR DOUBLE TYRES	91.10 ~ 95. 5	HN-368				FN-1201 FN-3340
TE2H41 1.8t SINGLE TYRE	91.10 ~ 95. 5		FN-1197			FN-1197 FN-3340
TE2S41 SINGLE TYRE	91.10 ~ 95. 5		FN-1197			FN-1197 FN-3340
4200 SG2H41 2t LOW FLAT FLOOR DOUBLE TYRES	91.10 ~ 95. 5	HN-368				FN-1201
SG2S41 LOW FLAT FLOOR DOUBLE TYRES	91.10 ~ 95. 5	HN-368				FN-1201
DG2H41 DUMP TRUCK 2t LOW FLAT FLOOR DOUBLE TYRES	91.10 ~ 95. 5	HN-368				FN-1201
DG2S41 LOW FLAT FLOOR DOUBLE TYRES	91.10 ~ 95. 5	HN-368				FN-1201
DG7YH41	91.10 ~ 95. 5	HN-368				FN-1201
LG2YH41 DOUBLE WIDTH 3t LOW FLAT FLOOR DOUBLE TYRES	91.10 ~ 95. 5	HN-368				FN-1201
LG2YS41 3t LOW FLAT FLOOR DOUBLE TYRES	91.10 ~ 95. 5	HN-368				FN-1201
LG4YH41 DOUBLE WIDTH LOW FLAT FLOOR DOUBLE TYRES	91.10 ~ 95. 5	HN-368				FN-1201
LG4YS41 LOW FLAT FLOOR DOUBLE TYRES	91.10 ~ 95. 5	HN-368				FN-1201
LG7YH41	91.10 ~ 95. 5	HN-368				FN-1201
LG8YH41	91.10 ~ 95. 5	HN-368				FN-1201
UG4YH41 2t LOW FLAT FLOOR DOUBLE TYRES	92. 1 ~ 95. 5	HN-368				FN-1201
UG4YS41 LOW FLAT FLOOR DOUBLE TYRES	92. 1 ~ 95. 5	HN-368				FN-1201
VG2YH41 DOUBLE WIDTH 2t LOW FLAT FLOOR DOUBLE TYRES	91.10 ~ 95. 5	HN-368				FN-1201
VG2YS41 LOW FLAT FLOOR DOUBLE TYRES	91.10 ~ 95. 5	HN-368				FN-1201
RG2YH41 2t DOUBLE WIDTH REFRIGERATOR CAR HIGH FLOOR DOUBLE TYRES	91.10 ~ 95. 5	HN-368				FN-1201
RG2YS41 HIGH FLOOR DOUBLE TYRES	91.10 ~ 95. 5	HN-368				FN-1201
ZG4YH41 2t DOUBLE WIDTH HIGH FLOOR DOUBLE TYRES	91.10 ~ 95. 5	HN-368				FN-1201
ZG4YS41 HIGH FLOOR DOUBLE TYRES	91.10 ~ 95. 5	HN-368				FN-1201
4300 AKR66E	95. 6 ~ 99. 4	HN-384	FN-4451			FN-4428 FN-4443
REFUSE CAR HIGH FLOOR	95. 6 ~ 99. 4	HN-288	FN-4451			FN-4451 FN-4443
AKR66G	95. 6 ~ 99. 4		FN-4451			FN-4451 FN-4443
AKR66L	95. 6 ~ 99. 4	HN-384	FN-4451			FN-4451 FN-4443
APR66G	95. 6 ~ 99. 4	HN-288	FN-4451			FN-4451 FN-4443
APR66L	95. 6 ~ 99. 4	HN-288	FN-4451			FN-4451 FN-4443
APR66P	95. 6 ~ 99. 4	HN-288	FN-4451			FN-4451 FN-4443
BKR66E	95. 6 ~ 99. 4	HN-384	FN-4451			FN-4428 FN-4443
REFUSE CAR HIGH FLOOR	95. 6 ~ 99. 4	HN-288	FN-4451			FN-4451 FN-4443
BKR66G	95. 6 ~ 99. 4		FN-4451			FN-4451 FN-4443
BKR66L	95. 6 ~ 99. 4	HN-384	FN-4451			FN-4451 FN-4443

- NISSAN
- TOYOTA (HINO)
- MAZDA
- ISUZU
- HONDA
- MITSUBISHI
- SUBARU
- SUZUKI
- DAIHATSU
- LEXUS
- INFINITY
- HYUNDAI
- KIA

NISSAN - 6

- NISSAN
- TOYOTA
(HINO)
- MAZDA
- ISUZU
- HONDA
- MITSUBISHI
- SUBARU
- SUZUKI
- DAIHATSU
- LEXUS
- INFINITI
- HYUNDAI
- KIA

Model 車種形式	Year 年式	Front フロント		Rear リア		Parking パーキング
		Pad パッド	Shoe シュー	Pad パッド	Shoe シュー	Shoe シュー
ATLAS CONDOR						
4300 BPR66G	95. 6 ~ 99. 4	HN-288	FN-4451		FN-4451	FN-4443
BPR66L	95. 6 ~ 99. 4	HN-288	FN-4451		FN-4451	FN-4443
BPR66P	95. 6 ~ 99. 4	HN-288	FN-4451		FN-4451	FN-4443
BKS66G	95.12 ~ 99. 4	HN-384			FN-4451	FN-4443
4600 RH4YH41	91.10 ~ 95. 5	HN-368			FN-1201	
RH4YS41	91.10 ~ 95. 5	HN-368			FN-1201	
UH4YH41	LOW FLAT FLOOR DOUBLE TYRES 92. 1 ~ 95. 5	HN-368			FN-1201	
UH4YS41	LOW FLAT FLOOR DOUBLE TYRES 92. 1 ~ 95. 5	HN-368			FN-1201	
UH5YH41	LOW FLAT FLOOR DOUBLE TYRES 92. 1 ~ 95. 5	HN-368			FN-1201	
UH5YS41	LOW FLAT FLOOR DOUBLE TYRES 92. 1 ~ 95. 5	HN-368			FN-1201	
AKR71E	95. 6 ~ 99. 4	HN-384	FN-4451		FN-4451	FN-4443
DUST VEHICLE DOUP TRUCK	95. 6 ~ 99. 4	HN-288	FN-4451		FN-4451	FN-4443
AKR71G	95. 6 ~ 99. 4		FN-4451		FN-4451	FN-4443
AKR71L	95. 6 ~ 99. 4	HN-384	FN-4451		FN-4451	FN-4443
APR71G	95. 6 ~ 99. 4	HN-288	FN-4451		FN-4451	FN-4443
APR71L	95. 6 ~ 99. 4	HN-288	FN-4451		FN-4451	FN-4443
APR71P	95. 6 ~ 99. 4	HN-288	FN-4451		FN-4451	FN-4443
APS71G	95. 6 ~ 99. 4		FN-4451		FN-4459	FN-4443
APS71L	95. 6 ~ 99. 4		FN-4451		FN-4459	FN-4443
BKR71E	95. 6 ~ 99. 4	HN-384	FN-4451		FN-4451	FN-4443
DUST VEHICLE DOUP TRUCK	95. 6 ~ 99. 4	HN-288	FN-4451		FN-4451	FN-4443
BKR71G	95. 6 ~ 99. 4		FN-4451		FN-4451	FN-4443
BKR71L	95. 6 ~ 99. 4	HN-384	FN-4451		FN-4451	FN-4443
BPR71G	95. 6 ~ 99. 4	HN-288	FN-4451		FN-4451	FN-4443
BPR71L	95. 6 ~ 99. 4	HN-288	FN-4451		FN-4451	FN-4443
BPR71P	95. 6 ~ 99. 4	HN-288	FN-4451		FN-4451	FN-4443
4800 APR70G	95. 6 ~ 99. 4	HN-288	FN-4451		FN-4451	FN-4404
APR70L	95. 6 ~ 99. 4	HN-288	FN-4451		FN-4451	FN-4404
APR70P	95. 6 ~ 99. 4	HN-288	FN-4451		FN-4451	FN-4404
BPR70G	95. 6 ~ 99. 4	HN-288	FN-4451		FN-4451	FN-4404
BPR70L	95. 6 ~ 99. 4	HN-288	FN-4451		FN-4451	FN-4404
BPR70P	95. 6 ~ 99. 4	HN-288	FN-4451		FN-4451	FN-4404
AVENIR						
1600 VEW10	W/O ABS 90. 5 ~ 99. 6	HN-359			FN-1170	
	W/ ABS 93. 1 ~ 99. 6	HN-176		HN-224		
VENW10	90.10 ~ 99. 6	HN-359			FN-1170	
1800 W10	W/O ABS 90. 5 ~ 95. 8	HN-359			FN-1170	
	W/ ABS 93. 1 ~ 95. 8	HN-176		HN-224		
SALUT B	95. 8 ~ 98. 8	HN-176		HN-224	FN-1170	
W11	98. 8 ~ 05. 9	HN-201A			FN-1170	
2000 PW10	90. 5 ~ 98. 8	HN-176		HN-224		
PNW10	90. 5 ~ 98. 8	HN-176		HN-224	FN-1170	
GT-TURBO SALUT	95. 8 ~ 98. 8	HN-309		HN-224		
PW11	98. 8 ~ 01. 1	HN-201A		HN-224		

NISSAN - 7

Model 車種形式			Year 年式	Front フロント		Rear リア		Parking パーキング
				Pad パッド	Shoe シュー	Pad パッド	Shoe シュー	Shoe シュー
AVENIR								
2000	PW11		01. 1 ~ 02. 8	HN-201A		HN-467		
	PNW11		98. 8 ~ 01. 1	HN-201A		HN-224		
			01. 1 ~ 02. 8	HN-201A		HN-467		
	GT-4		98. 8 ~ 01. 1	HN-261		HN-224		
			01. 1 ~ 02. 8	HN-201A		HN-467		
	SW10		93. 1 ~ 98. 8	HN-176		HN-224		
	SW11		98. 8 ~ 00. 5	HN-201A			FN-1170	
	VSW10	W/O ABS	90. 5 ~ 99. 6	HN-359			FN-1170	
		W/ ABS	93. 1 ~ 99. 6	HN-176		HN-224		
	RW11, RNW11		02. 8 ~ 05. 9	HN-201A		HN-467		
INFINITI Q45								
4500	G50, HG50		94.11 ~ 98. 3	HN-261		HN-262		
	NG50, NHG50		94.11 ~ 98. 3	HN-261		HN-262		
WINGROAD								
1500	WFY10	LE	W/O ABS	96. 5 ~ 99. 6	HN-356		FN-1185	
		LE, JS	W/ ABS	96. 5 ~ 99. 6	HN-356		FN-1198	
	WFNY10	LE	W/O ABS	96. 5 ~ 99. 6	HN-356		FN-1170	
		LE, JS	W/ ABS	96. 5 ~ 99. 6	HN-356		FN-1198	
	WFY11	LE	W/O ABS	99. 5 ~ 00.10	HN-435		FN-1170	
		LE, G	W/ ABS	99. 5 ~ 05.11	HN-435		FN-1198	
	Y12			05.11 ~	HN-452		FN-1267	
	NY12	4WD		05.11 ~ 14. 9	HN-452		FN-1264	
1800	WHY10		W/O ABS	96. 5 ~ 99. 6	HN-356		FN-1170	
			W/ ABS	96. 5 ~ 99. 6	HN-356		FN-1198	
	WHNY10		W/O ABS	96. 5 ~ 97. 5	HN-356		FN-1170	
			W/ ABS	96. 5 ~ 99. 6	HN-356		FN-1198	
	WHY11	Z		99. 5 ~ 01.10	HN-435		FN-1198	
		ZX		00.10 ~ 01.10	HN-435		FN-1170	
	WHNY11			99. 5 ~ 05.11	HN-435		FN-1170	
	JY12			05.11 ~ 14. 9	HN-452		FN-1267	
2000	WEY10	LE	W/O ABS	96. 5 ~ 99. 6	HN-356		FN-1185	
		LE, JS	W/ ABS	96. 5 ~ 99. 6	HN-356		FN-1198	
	WPY11	ZV		99. 5 ~ 01.10	HN-201A	HN-224		
		ZV-S		01. 1 ~ 01.10	HN-201A	HN-467		
	WRY11			01.10 ~ 05.11	HN-435		FN-1198	
EXPERT								
1800	VW11		W/O ABS	99. 6 ~ 05.11	HN-435		FN-1170	
			W/ ABS	99. 6 ~ 05.11	HN-435		FN-1198	
	VNW11			99. 6 ~ 05.11	HN-435		FN-1170	
2200	VEW11		W/O ABS	99. 6 ~ 05.11	HN-435		FN-1170	
			W/ ABS	99. 6 ~ 05.11	HN-435		FN-1198	
	VENW11			99. 6 ~ 05.11	HN-435		FN-1170	

- NISSAN
- TOYOTA
(HINO)
- MAZDA
- ISUZU
- HONDA
- MITSUBISHI
- SUBARU
- SUZUKI
- DAIHATSU
- LEXUS
- INFINITI
- HYUNDAI
- KIA

NISSAN - 8

- NISSAN
- TOYOTA
(HINO)
- MAZDA
- ISUZU
- HONDA
- MITSUBISHI
- SUBARU
- SUZUKI
- DAIHATSU
- LEXUS
- INFINITI
- HYUNDAI
- KIA

Model 車種形式	Year 年式	Front フロント		Rear リア		Parking パーキング
		Pad パッド	Shoe シュー	Pad パッド	Shoe シュー	Shoe シュー
X-TRAIL						
2000 T30, NT30	00.10 ~ 07. 8	HN-531		HN-466		
PNT30	00.10 ~ 07. 8	HN-531		HN-466		
T31, NT31	07. 8 ~ 13.12	HN-546		HN-466		
DNT31	08. 9 ~ 13.12	HN-546		HN-466		
2500 TNT31	07. 8 ~ 13.12	HN-546		HN-466		
ESCARGOT						
1500 G20	89. 1 ~ 94. 3	HN-108			FN-1167	
ELGRAND						
2500 ME51, MNE51	04.12 ~ 10. 8	HN-488		HN-466		
TE52, TNE52	10. 8 ~	HN-610		HN-565		
3000 ATE50, ATWE50	99. 8 ~ 02. 5	HN-531			FN-1174	
3200 AVE50, AVWE50	97. 5 ~ 99. 8	HN-531			FN-1174	
3300 ALE50, ALWE50	97. 5 ~ 02. 5	HN-531			FN-1174	
AE50, JFLGE50 HIGH STANDARD AMBULANCE	01. 2 ~	HN-531			FN-1189	
3500 APE50, APWE50	98. 8 ~ 02. 5	HN-531			FN-1174	
E51, NE51	02. 5 ~ 10. 8	HN-488		HN-466		
PE52, PNE52	10. 8 ~	HN-610		HN-565		
OTTI						
660 H91W	05. 6 ~ 06.10	HN-453			FN-6726	
H92W	06.10 ~ 07. 8	HN-453			FN-6726	
	07. 8 ~ 13. 6	HN-437			FN-6726	
TURBO	07. 8 ~ 13. 6	HN-453			FN-6726	
KIX						
660 H59A	08.10 ~ 12. 8	HN-417			FN-6723	
CARAVAN・HOMY						
2000 KHE24, KHGE24	86. 9 ~ 95. 8	HN-137			FN-1174	
VTE24, VTGE24	92.10 ~ 99. 6	HN-137			FN-1174	
CTGE24	92.10 ~ 99. 6	HN-137			FN-1174	
CPGE24	99. 6 ~ 02. 7	HN-531			FN-1189	
DTGE24, FTGE24	92.10 ~ 99. 6	HN-137			FN-1174	
VPE24, VPGE24	99. 6 ~ 02. 7	HN-531			FN-1189	
VPE25	01. 4 ~ 07. 8	HN-475			FN-1174	
VRE25	07. 8 ~ 12. 6	HN-475			FN-1174	
VR2E26	12. 6 ~	HN-475			FN-1174	
2400 CQGE24	99. 6 ~ 01. 4	HN-531			FN-1189	
CQGE25	01. 4 ~ 07. 8	HN-475			FN-1174	
DQGE25 MICROBUS	01. 4 ~ 07. 8	HN-475			FN-1174	
QE25, QGE25	01.11 ~ 07. 8	HN-475			FN-1174	

NISSAN - 9

Model 車種形式	Year 年式	Front フロント		Rear リア		Parking パーキング
		Pad パッド	Shoe シュー	Pad パッド	Shoe シュー	Shoe シュー
CARAVAN・HOMY						
2500 SE25, SGE25	07. 8 ~ 12. 6	HN-475				FN-1174
CSGE25	07. 8 ~ 12. 6	HN-475				FN-1174
DSGE25	07. 8 ~ 12. 6	HN-475				FN-1174
VW2E26, VW6E26, VW8E26, KS2E26, KS4E26	12. 6 ~	HN-475				FN-1174
2700 CRGE24	92.10 ~ 97. 5	HN-137				FN-1174
CRMGE24	92.10 ~ 96. 9	HN-137				FN-1174
VRMGE24	92.10 ~ 97. 5	HN-137				FN-1174
VRGE24	92.10 ~ 97. 5	HN-137				FN-1174
VRE24	92.10 ~ 97. 5	HN-137				FN-1174
DRGE24	92.10 ~ 97. 5	HN-137				FN-1174
ARGE24	87.10 ~ 99. 6	HN-137				FN-1174
KRME24	87.10 ~ 99. 6	HN-137				FN-1174
KRMGE24	88.10 ~ 99. 6	HN-137				FN-1174
KRGE24	90.10 ~ 99. 6	HN-137				FN-1174
ARE24, KRE24	88.10 ~ 99. 6	HN-137				FN-1174
ARME24	90.10 ~ 97. 5	HN-137				FN-1174
ARMGE24	90.10 ~ 99. 6	HN-137				FN-1174
3000 KEE24	88.10 ~ 97. 5	HN-137				FN-1174
AEGE24	88.10 ~ 99. 6	HN-137				FN-1174
FEGE24	93. 5 ~ 99. 6	HN-137				FN-1174
VWE25	01. 4 ~ 12. 6	HN-475				FN-1174
VWME25	01. 4 ~ 12. 6	HN-475				FN-1174
CWGE25	01. 4 ~ 12. 6	HN-475				FN-1174
CWMGE25	01. 4 ~ 12. 6	HN-475				FN-1174
DWGE25 MICROBUS	01. 4 ~ 12. 6	HN-475				FN-1174
DWMGE25 MICROBUS	01. 4 ~ 12. 6	HN-475				FN-1174
3200 VWE24	96. 8 ~ 99. 6	HN-137				FN-1174
	99. 6 ~ 01. 4	HN-531				FN-1189
VWGE24	96. 8 ~ 99. 6	HN-137				FN-1174
	99. 6 ~ 01. 4	HN-531				FN-1189
VWME24	99. 6 ~ 01. 4	HN-531				FN-1189
VWMGE24	96. 8 ~ 99. 6	HN-137				FN-1174
	99. 6 ~ 01. 4	HN-531				FN-1189
CWGE24	96. 8 ~ 99. 6	HN-137				FN-1174
	99. 6 ~ 01. 4	HN-531				FN-1189
CWMGE24	96. 8 ~ 99. 6	HN-137				FN-1174
	99. 6 ~ 01. 4	HN-531				FN-1189
DWGE24	97. 5 ~ 01. 4	HN-137				FN-1174
CUBE						
1300 Z10	98. 2 ~ 99.11	HN-420				FN-1204
AZ10 S	99.11 ~ 00. 9	HN-420				FN-1204
S-A	00. 9 ~ 02.10	HN-435				FN-1204
SQUARE, NAVI	99.11 ~ 02.10	HN-435				FN-1198
ANZ10	99.11 ~ 02.10	HN-435				FN-1198

- NISSAN
- TOYOTA
(HINO)
- MAZDA
- ISUZU
- HONDA
- MITSUBISHI
- SUBARU
- SUZUKI
- DAIHATSU
- LEXUS
- INFINITY
- HYUNDAI
- KIA

NISSAN - 10

- NISSAN
- TOYOTA
(HINO)
- MAZDA
- ISUZU
- HONDA
- MITSUBISHI
- SUBARU
- SUZUKI
- DAIHATSU
- LEXUS
- INFINITI
- HYUNDAI
- KIA

Model 車種形式	Year 年式	Front フロント		Rear リア		Parking パーキング
		Pad パッド	Shoe シュー	Pad パッド	Shoe シュー	Shoe シュー
CUBE						
1400 BZ11		02.10 ~ 08.11	HN-452			FN-1261
1400 BNZ11	SX	02.10 ~ 05. 5	HN-452			FN-1198
	14S	05. 5 ~ 08.11	HN-452			FN-1264
BGZ11	SX	03. 9 ~ 05. 5	HN-452			FN-1198
	14S	05. 5 ~ 08.11	HN-452			FN-1264
1500 YZ11		05. 5 ~ 08.11	HN-452			FN-1261
YGZ11		05. 5 ~ 08.11	HN-452			FN-1264
YGNZ11		05. 5 ~ 08.11	HN-452			FN-1264
Z12		08.11 ~	HN-555			FN-1267
NZ12		08.11 ~ 14.11	HN-555			FN-1264
CLIPPER						
660 U71V, U72V	VAN	03.10 ~ 12. 1	HN-437			FN-6729
U71T, U72T	TRUCK	03.10 ~ 12. 1	HN-437			FN-6729
U71TP, U72TP	PANEL VAN	03.10 ~ 13.12	HN-437			FN-6729
U71W, U72W	R10	07. 6 ~ 12. 1	HN-453			FN-6729
CREW						
2000 HK30	SEDAN	94. 1 ~ 96. 9	HN-343T			FN-1198
		96. 9 ~ 02. 8	HN-343T			FN-1170
QK30	TAXI (LPG)	93. 7 ~ 96. 9	HN-343T			FN-1198
		96. 9 ~ 09. 8	HN-343T			FN-1170
THK30, YHK30	SEDAN	94. 1 ~ 96. 9	HN-343T			FN-1198
		96. 9 ~ 02. 8	HN-343T			FN-1170
2800 SK30	SEDAN	93. 7 ~ 96. 9	HN-343T			FN-1198
		96. 9 ~ 02. 8	HN-343T			FN-1170
	TAXI	93. 7 ~ 96. 9	HN-343T			FN-1198
		96. 9 ~ 02. 8	HN-343T			FN-1170
TSK30	FOR DRIVING TRAINING SCHOOL	93. 7 ~ 96. 9	HN-343T			FN-1198
		96. 9 ~ 02. 8	HN-343T			FN-1170
SUNNY CALIFORNIA						
1500 WFY10		94. 8 ~ 96. 5	HN-225			FN-1198
WFNY10	W/O ABS	90.10 ~ 96. 5	HN-225			FN-1170
	W/ ABS	90.10 ~ 96. 5	HN-225			FN-1198
SUNNY・LUCINO						
1300 B14	W/O ABS	94. 1 ~ 98.10	HN-356			FN-1185
	W/ ABS	97. 5 ~ 98.10	HN-356			FN-1167
B15		98.10 ~ 04.10	HN-435			FN-1167
1500 FB14	W/O ABS	94. 1 ~ 98.10	HN-356			FN-1185
	W/ ABS	94. 1 ~ 98.10	HN-356		HN-357	
		97. 5 ~ 98.10	HN-356			FN-1167
FB15		98.10 ~ 04.10	HN-435			FN-1167
FNB14	W/O ABS	94. 1 ~ 98.10	HN-356			FN-1170
	W/ ABS	94. 1 ~ 98.10	HN-356		HN-283	

NISSAN - 11

Model 車種形式	Year 年式	Front フロント		Rear リア		Parking パーキング
		Pad パッド	Shoe シュー	Pad パッド	Shoe シュー	Shoe シュー
SUNNY・LUCINO						
1500 FNB15 4WD	98.10 ~ 04.10	HN-435				FN-1170
FN15 W/O ABS	95.1 ~ 00.8	HN-356				FN-1185
W/ ABS	95.1 ~ 00.8	HN-356		HN-357		
FNN15 W/O ABS	95.1 ~ 00.8	HN-356				FN-1170
W/ ABS	95.1 ~ 00.8	HN-356		HN-283		
1600 EB14	94.1 ~ 97.5	HN-356				FN-1185
	97.5 ~ 98.10	HN-356				FN-1167
EN15 W/O ABS	95.1 ~ 97.9	HN-356				FN-1185
W/ ABS	97.9 ~ 99.4	HN-356				FN-1167
W/ ABS	95.1 ~ 99.4	HN-356		HN-357		
JB15	98.10 ~ 01.5	HN-201A		HN-224		
	01.5 ~ 02.5	HN-201A		HN-467		
1800 HB14	94.1 ~ 98.10	HN-356		HN-357		
HN15 15AW, 195TYRE	95.1 ~ 99.4	HN-268		HN-224		
THE ABOVE IS EXCLUDED	95.1 ~ 99.4	HN-356		HN-357		
QB15	98.10 ~ 02.5	HN-435				FN-1167
HNN15	96.5 ~ 99.4	HN-268		HN-224		
2000 SB14 W/O ABS	94.1 ~ 99.9	HN-356				FN-1185
W/ ABS	94.1 ~ 99.9	HN-356		HN-357		
	97.5 ~ 99.9	HN-356				FN-1167
SNB14 W/O ABS	94.1 ~ 99.9	HN-356				FN-1170
W/ ABS	94.1 ~ 99.9	HN-356		HN-283		
2200 SB15	99.9 ~ 02.5	HN-435				FN-1167
SAFARI						
2800 WYY60	94.10 ~ 97.10	HN-132B		HN-371		
WYY61	97.10 ~ 99.9	HN-413		HN-199		
3000 WTY61	99.9 ~ 02.11	HN-413		HN-199		FN-8802
4200 VRY60, VRGY60	87.10 ~ 98.3	HN-132B		HN-371		FN-8802
FGY60 FIRE ENGINE	87.10 ~ 97.10	HN-132B				FN-8802
WRY60	91.2 ~ 97.10	HN-132B		HN-371		FN-8802
WGY60	91.10 ~ 97.10	HN-308		HN-371		FN-8802
WRGY60	91.2 ~ 97.10	HN-132B		HN-371		FN-8802
WRGY61	97.10 ~ 99.9	HN-413		HN-199		FN-8802
VRGY61	99.9 ~ 02.11	HN-413		HN-199		FN-8802
4500 WGY61	97.10 ~ 02.11	HN-413		HN-199		FN-8802
4800 WFGY61	02.11 ~					
CIMA						
3000 FPY31, FPAY31	88.1 ~ 91.8	HN-137		HN-200		
FPY32	93.9 ~ 96.6	HN-261		HN-262		

- NISSAN
- TOYOTA (HINO)
- MAZDA
- ISUZU
- HONDA
- MITSUBISHI
- SUBARU
- SUZUKI
- DAIHATSU
- LEXUS
- INFINITY
- HYUNDAI
- KIA

NISSAN - 12

- NISSAN
- TOYOTA
(HINO)
- MAZDA
- ISUZU
- HONDA
- MITSUBISHI
- SUBARU
- SUZUKI
- DAIHATSU
- LEXUS
- INFINITI
- HYUNDAI
- KIA

Model 車種形式	Year 年式	Front フロント		Rear リア		Parking パーキング
		Pad パッド	Shoe シュー	Pad パッド	Shoe シュー	Shoe シュー
CIMA						
3000 FHY33	96. 6 ~ 97. 9	HN-261		HN-262		
TRACTION CONTROL IS WITH IT	97. 9 ~ 98. 9	HN-261		HN-262		
THE ABOVE IS EXCLUDED	97. 9 ~ 01. 1	HN-531		HN-262		
HF50 TURBO	01. 1 ~ 07.10	HN-444		HN-262		
3500 HGY51 HYBRID	12. 5 ~	HN-444		HN-565		
4100 FGY32, FGDY32	91. 8 ~ 96. 6	HN-261		HN-262		
FGNY32	92. 9 ~ 96. 6	HN-261		HN-262		
FGY33, FGDY33	96. 6 ~ 01. 1	HN-531		HN-262		
FGNY33	97. 9 ~ 01. 1	HN-531		HN-262		
4500 GF50, GNF50	01. 1 ~ 10. 8	HN-444		HN-262		
CIVILIAN						
3000 ECW41, EHW41	08. 6 ~	HN-464※1			FN-1201	
EJW41, EVW41	08. 6 ~	HN-464※1			FN-1201	
3500 BW40, BGW40	90. 6 ~ 99. 2	HN-368			FN-1201	FN-3340
4200 RW40, RGW40	93. 4 ~ 99. 2	HN-368			FN-1201	
RYW40	93. 4 ~ 99. 2	HN-368			FN-1201	
RAW40	93. 4 ~ 99. 2	HN-368			FN-1201	
BCW41, BHW41	99. 2 ~ 04. 9	HN-464※1			FN-1201	
BJW41, BVW41	99. 2 ~ 04. 9	HN-464※1			FN-1201	
4500 DCW41, DHW41	04. 9 ~	HN-464※1			FN-1201	
DJW41, DVW41	04. 9 ~	HN-464※1			FN-1201	
4900 AHW41 INFANT CAR	04. 9 ~ 07. 8	HN-464※1			FN-6653	FN-4443
THE ABOVE IS EXCLUDED	04. 9 ~ 07. 8	HN-513			FN-6653	FN-4443
ACW41, AJW41	04. 9 ~ 07. 8	HN-513			FN-6653	FN-4443
AVW41	04. 9 ~ 07. 8	HN-513			FN-6653	FN-4443
※1 CAN NOT BE FITTED MOUTING SHIM GENUINE						
SILVIA・GAZELLE						
1800 S13, KS13	88. 5 ~ 91. 1	HN-367		HN-377		
2000 PS13	91. 1 ~ 93.10	HN-367		HN-377		
TURBO	91. 1 ~ 93.10	HN-201A		HN-377		
KPS13	91. 1 ~ 93.10	HN-201A		HN-377		
S14, CS14	93.10 ~ 96. 6	HN-199		HN-377		
	96. 6 ~ 99. 1	HN-176		HN-377		
TURBO	93.10 ~ 99. 1	HN-358		HN-377		
S15	99. 1 ~ 02. 8	HN-201A		HN-377		
TURBO	99. 1 ~ 02. 8	HN-220		HN-377		
AUTECH	99. 9 ~ 02. 8	HN-220		HN-377		

NISSAN - 13

Model 車種形式	Year 年式	Front フロント		Rear リア		Parking パーキング
		Pad パッド	Shoe シュー	Pad パッド	Shoe シュー	Shoe シュー
JUKE						
1500 YF15	10. 6 ~ 11. 5	HN-474			FN-1264	
1600 F15,NF15	10.11 ~	HN-474		HN-565		
SKYLINE						
1800 FR32	89. 5 ~ 93. 8	HN-199			FN-1170	
2000 HR32, YHR32	89. 5 ~ 93. 8	HN-176		HN-270		
HCR32	89. 5 ~ 93. 8	HN-176		HN-270		
TURBO	89. 5 ~ 93. 8	HN-201A		HN-270		
TYPE-M	89. 5 ~ 93. 8	HN-220		HN-221		
HNR32	89. 5 ~ 93. 8	HN-220		HN-221		
HR33	93. 8 ~ 99. 1	HN-176		HN-270		
HR34	98. 5 ~ 01. 6	HN-317		HN-422		
16INCH WHEEL	98. 5 ~ 01. 6	HN-309		HN-422		
2500 ER33	GTS25TYPE X	93. 8 ~ 98. 5	HN-309	HN-270		
	GTS25TYPE S, TURBO	93. 8 ~ 98. 5	HN-358	HN-221		
ECR33		93. 8 ~ 98. 5	HN-309	HN-270		
TURBO		93. 8 ~ 98. 5	HN-358	HN-221		
ENR33		93. 8 ~ 98. 5	HN-309	HN-270		
ER34		98. 5 ~ 01. 6	HN-309	HN-422		
17INCH TURBO		98. 5 ~ 01. 6	HN-358	HN-221		
ENR34		98. 5 ~ 01. 6	HN-309	HN-422		
V35		01. 6 ~ 02. 4	HN-504	HN-466		
		02. 4 ~ 03. 1	HN-505	HN-466		
NV35	4WD	03. 1 ~ 06.11	HN-474	HN-466		
		01. 6 ~ 02. 4	HN-504	HN-466		
		02. 4 ~ 06.11	HN-505	HN-466		
V36		06.11 ~ 09. 8	HN-444	HN-466		
NV36	4WD	06.11 ~ 09. 8	HN-444	HN-466		
		09. 8 ~ 14. 2	HN-444	HN-565		
2600 BCNR33		95. 1 ~ 99. 1				
BNR34	GTR	95. 1 ~ 02. 8				
3000 HV35		01. 6 ~ 02. 4	HN-504	HN-466		
		02. 4 ~ 03. 1	HN-505	HN-466		
		03. 1 ~ 04.11	HN-474	HN-466		
3500 PV35	AT	02. 1 ~ 06.11	HN-474	HN-466		
	MT	04.11 ~ 06.11	HN-444	HN-466		
CPV35		03. 1 ~ 04.11	HN-474	HN-466		
		04.11 ~ 06.11	HN-444	HN-466		
PV36	Excl. Type S and SP	06.11 ~ 14. 2	HN-444	HN-466		
	Type S, SP	06.11 ~ 14. 2		HN-466		
3700 KV36	TYPE P	08.12 ~ 09. 8	HN-444	HN-466		
		09. 8 ~ 14. 6	HN-444	HN-565		

- NISSAN
- TOYOTA
(HINO)
- MAZDA
- ISUZU
- HONDA
- MITSUBISHI
- SUBARU
- SUZUKI
- DAIHATSU
- LEXUS
- INFINITY
- HYUNDAI
- KIA

NISSAN - 14

- NISSAN
- TOYOTA
(HINO)
- MAZDA
- ISUZU
- HONDA
- MITSUBISHI
- SUBARU
- SUZUKI
- DAIHATSU
- LEXUS
- INFINITI
- HYUNDAI
- KIA

Model 車種形式	Year 年式	Front フロント		Rear リア		Parking パーキング
		Pad パッド	Shoe シュー	Pad パッド	Shoe シュー	Shoe シュー
SKYLINE						
3700 KV36 Type S, SP	08.12 ~ 14. 6			HN-466		
CKV36 Excl. Type S and SP	07.10 ~ 16. 1			HN-565		
Type S, SP	07.10 ~ 16. 1			HN-557		
SKYLINE CROSOVER						
3700 J50, NJ50	09. 7 ~ 16. 6	HN-444		HN-565		
STAGEA						
2000 WHC34	96. 9 ~ 97. 8	HN-201A		HN-270		
	97. 8 ~ 01.10	HN-201A		HN-422		
2500 WGC34	96. 9 ~ 97. 8	HN-201A		HN-270		
	97. 8 ~ 01.10	HN-201A		HN-422		
WGNC34 RS-V, TURBO	98. 8 ~ 01.10	HN-444		HN-262		
	96. 9 ~ 97. 8	HN-309		HN-270		
	97. 8 ~ 01.10	HN-309		HN-422		
	96. 9 ~ 97. 8	HN-261		HN-270		
	97. 8 ~ 98. 8	HN-261		HN-422		
	98. 8 ~ 01.10	HN-444		HN-262		
M35	01.10 ~ 02. 4	HN-504		HN-466		
	02. 4 ~ 04. 3	HN-505		HN-466		
	04. 3 ~ 06.11	HN-474		HN-466		
NM35 4WD	06.11 ~ 07. 6	HN-505		HN-466		
	01.10 ~ 02. 4	HN-504		HN-466		
	02. 4 ~ 07. 6	HN-505		HN-466		
2600 WGNC34 AUTECH VERSION	97.11 ~ 01.10					
3000 HM35	01.10 ~ 02. 4	HN-504		HN-466		
	02. 4 ~ 04. 3	HN-505		HN-466		
	04. 3 ~ 04. 8	HN-474		HN-466		
3500 PM35	04. 8 ~ 06.11	HN-474		HN-466		
PNM35 4WD	04. 8 ~ 07. 6	HN-505		HN-466		
CEDRIC・GLORIA						
2000 WY30, VY30	83. 6 ~ 99. 6	HN-105			FN-1156	
VNY30	83. 6 ~ 95.11	HN-105			FN-1156	
Y31, TY31 W/O ABS	87. 6 ~ 02. 8	HN-105		HN-200		
W/ ABS	87. 6 ~ 02. 8	HN-137		HN-200		
CY31 W/O ABS	89. 6 ~ 99. 8	HN-105		HN-200		
W/ ABS	89. 6 ~ 99. 8	HN-137		HN-200		
MJY31, CMJY31	87. 6 ~ 98. 6	HN-105			FN-1156	
	98. 6 ~ 02. 8	HN-343T			FN-1156	
QJY31 LPG	91. 6 ~ 14.11	HN-343T			FN-1156	
BJY31, CBJY31 LPG	04. 1 ~ 07. 8	HN-343T			FN-1156	
YY31 W/O ABS	91. 6 ~ 95. 8	HN-105		HN-200		
W/ ABS	91. 6 ~ 95. 8	HN-137		HN-200		
Y32 W/O ABS	91. 6 ~ 95. 6	HN-105		HN-270		

NISSAN - 15

Model 車種形式		Year 年式	Front フロント		Rear リア		Parking パーキング
			Pad パッド	Shoe シュー	Pad パッド	Shoe シュー	Shoe シュー
CEDRIC・GLORIA							
2800	Y32	W/ ABS	91. 6 ~ 95. 6	HN-137		HN-270	
	Y33		96. 1 ~ 99. 6	HN-261		HN-270	
2500	MY33		97. 6 ~ 99. 6	HN-261		HN-270	
	ENY33		97. 6 ~ 99. 6	HN-261		HN-262	
	MY34		99. 6 ~ 04. 9	HN-261		HN-422	
	ENY34	TURBO	99. 6 ~ 04. 9	HN-444		HN-262	
2800	UY31, CUY31	W/O ABS	87. 6 ~ 02. 8	HN-105		HN-200	
		W/ ABS	87. 6 ~ 02. 8	HN-137		HN-200	
	UJY31		87. 6 ~ 99. 8	HN-343T		FN-1156	
	UY32		91. 6 ~ 95. 6	HN-137		HN-270	
	UY33		95. 6 ~ 99. 6	HN-261		HN-262	
3000	PY31	BROUGHAM	87. 6 ~ 02. 8	HN-105		HN-200	
		BROUGHAM VIP	87. 6 ~ 02. 8	HN-137		HN-200	
	PAY31	W/O ABS	87. 6 ~ 02. 8	HN-105		HN-200	
		W/ ABS	87. 6 ~ 02. 8	HN-137		HN-200	
	YPY31		91. 6 ~ 02. 8	HN-137		HN-200	
	PY32	BROUGHAM J, J2, AV, AV2	93. 6 ~ 95. 6	HN-137		HN-270	
		BROUGHAM, GT, GTAV, GTS	93. 6 ~ 95. 6	HN-261		HN-262	
		VG30DE	91. 6 ~ 95. 6	HN-137		HN-270	
		VG30DT	91. 6 ~ 95. 6	HN-261		HN-262	
	PAY32, PBY32		91. 6 ~ 95. 6	HN-261		HN-262	
	PY33, HY33		95. 6 ~ 99. 6	HN-261		HN-270	
		TURBO	95. 6 ~ 99. 6	HN-261		HN-262	
	HBY33		95. 6 ~ 99. 6	HN-261		HN-262	
	HY34		99. 6 ~ 04. 9	HN-261		HN-422	
		TURBO	99. 6 ~ 04. 9	HN-444		HN-262	
CEFIRO							
2000	A31, CA31	W/O ABS	90. 4 ~ 92. 6	HN-199		HN-270	
		W/ ABS	90. 4 ~ 92. 6	HN-176		HN-270	
		TURBO	90. 4 ~ 92. 6	HN-201A		HN-270	
	LA31	W/O ABS	92. 6 ~ 94. 8	HN-199		HN-270	
		W/ ABS	92. 6 ~ 94. 8	HN-176		HN-270	
		TURBO	92. 6 ~ 94. 8	HN-201A		HN-270	
	NA31		90. 8 ~ 92. 6	HN-201A		HN-270	
	LCA31, LNA31		92. 6 ~ 94. 8	HN-201A		HN-270	
	A32		94. 8 ~ 98.12	HN-201A		HN-224	
	WA32	STATION WAGON	97. 6 ~ 00. 8	HN-201A		HN-224	
	A33		98.12 ~ 00.12	HN-474		HN-224	
			00.12 ~ 01. 3	HN-474		HN-467	
			01. 3 ~ 02.12	HN-504		HN-467	
2500	PA32		94. 8 ~ 98.12	HN-201A		HN-224	
	WPA32	STATION WAGON	97. 6 ~ 00. 8	HN-201A		HN-224	
	PA33		98.12 ~ 00.12	HN-474		HN-224	
			00.12 ~ 02. 8	HN-474		HN-467	

- NISSAN
- TOYOTA
(HINO)
- MAZDA
- ISUZU
- HONDA
- MITSUBISHI
- SUBARU
- SUZUKI
- DAIHATSU
- LEXUS
- INFINITY
- HYUNDAI
- KIA

NISSAN - 16

- NISSAN
- TOYOTA
(HINO)
- MAZDA
- ISUZU
- HONDA
- MITSUBISHI
- SUBARU
- SUZUKI
- DAIHATSU
- LEXUS
- INFINITI
- HYUNDAI
- KIA

Model 車種形式	Year 年式	Front フロント		Rear リア		Parking パーキング
		Pad パッド	Shoe シュー	Pad パッド	Shoe シュー	Shoe シュー
CEFIRO						
3000 HA32	94. 8 ~ 98.12	HN-201A		HN-224		
WHA32 STATION WAGON	97. 6 ~ 99. 8	HN-201A		HN-224		
SERENA						
1600 VAJC23	91. 6 ~ 99. 6	HN-188			FN-1198	
KAJC23 FG	91. 6 ~ 97. 1	HN-245			FN-1193	
SERENA						
2000 VVJC23, KVJC23	91. 6 ~ 99. 6	HN-188			FN-1198	
KVC23, KBC23	91. 6 ~ 99. 6	HN-245			FN-1193	
KBCC23	91. 6 ~ 99. 6	HN-245			FN-1193	
KBNC23	91. 6 ~ 99. 6	HN-245			FN-1193	
KVNC23	91. 6 ~ 99. 6	HN-245			FN-1193	
PC24, PNC24	99. 6 ~ 01.12	HN-531			FN-1193	
TC24, TNC24	01.12 ~ 05. 5	HN-531			FN-1193	
C25, NC25	05. 5 ~ 07. 3	HN-517		HN-466		
	07. 3 ~ 10. 6	HN-517		HN-466		
CC25, CNC25 HIGHWAY STAR	06. 6 ~ 07. 3	HN-517		HN-466		
	07. 3 ~ 10. 6	HN-517		HN-466		
2500 VC24, VNC24	99. 6 ~ 01.12	HN-531			FN-1193	
RC24	01.12 ~ 05. 5	HN-531			FN-1193	
DATSUN TRUCK						
1600 D21, GD21	89. 9 ~ 95. 8	HN-105			FN-1174	
2000 QD21, QGD21	89. 9 ~ 97. 1	HN-105			FN-1174	
QYD21, QMD21	89. 9 ~ 97. 1	HN-105			FN-1189	
QD22	97. 1 ~ 99. 6	HN-137			FN-1174	
PD22, LPD22	99. 6 ~ 02. 8	HN-137			FN-1174	
2400 LFMD22	97. 1 ~ 02. 8	HN-137			FN-189	
LFD22	99. 6 ~ 02. 8	HN-137			FN-1174	
2700 BMD21	89. 9 ~ 97. 1	HN-105			FN-1189	
TURBO	92. 8 ~ 97. 1	HN-137			FN-1189	
BD21, BGD21	92. 8 ~ 97. 1	HN-105			FN-1174	
BD22, LBD22	97. 1 ~ 02. 8	HN-137			FN-1174	
3200 LRMD22	97. 1 ~ 02. 8	HN-137			FN-1189	
AUTECH VERSION	98. 8 ~ 99. 6	HN-137			FN-1174	
TEANA						
2300 J31	03. 2 ~ 08. 6	HN-504		HN-466		
2500 TNJ31 4WD	03. 2 ~ 08. 6	HN-504		HN-466		
J32, TNJ32	08. 6 ~ 10. 7	HN-474		HN-466		
	10. 7 ~ 14. 2	HN-474		HN-565		
L33	14. 2 ~			HN-565		

NISSAN - 17

Model 車種形式	Year 年式	Front フロント		Rear リア		Parking パーキング
		Pad パッド	Shoe シュー	Pad パッド	Shoe シュー	Shoe シュー
TEANA						
3500 PJ31	03. 2 ~ 08. 6	HN-504		HN-466		
PJ32	08. 6 ~ 10. 7	HN-474		HN-466		
	10. 7 ~ 14. 2	HN-474		HN-565		
TIIDA						
1500 C11	04. 9 ~ 12. 9	HN-452			FN-1267	
NC11 4WD	04. 9 ~ 12. 9	HN-452			FN-1264	
1800 JC11	05. 1 ~	HN-452			FN-1267	
TIIDA・LATIO						
1500 SC11	04.10 ~ 12.10	HN-452			FN-1267	
SNC11 4WD	04.10 ~ 12.10	HN-452			FN-1264	
1800 SJC11	05. 1 ~ 12.10	HN-452			FN-1267	
TINO						
1800 V10, PV10	98.12 ~ 01. 1	HN-474		HN-224		
	01. 1 ~ 03. 2	HN-474		HN-467		
2000 HV10	98.12 ~ 01. 1	HN-474		HN-224		
	01. 1 ~ 02.10	HN-474		HN-467		
DUALIS						
2000 J10, J10E	07. 5 ~ 09. 9	HN-546		HN-466		
NJ10 4WD	07. 5 ~ 09. 9	HN-546		HN-466		
TERRANO・REGULUS						
2700 WBYD21	88.11 ~ 95. 8	HN-137		HN-304		
LBYD21	93. 1 ~ 95. 8	HN-137		HN-304		
PR50	95. 9 ~ 99. 2	HN-531			FN-1189	
3000 WHYD21	87.10 ~ 95. 8	HN-137		HN-304		
LHYD21	93. 1 ~ 95. 8	HN-137		HN-304		
TR50, JTR50	99. 2 ~ 02. 8	HN-531			FN-1189	
3200 RR50, JRR50	96. 8 ~ 99. 2	HN-531			FN-1189	
3300 LR50, JLR50	95. 9 ~ 02. 8	HN-531			FN-1189	
LUR50	99. 2 ~ 02. 8	HN-531			FN-1189	
JLUR50	99. 2 ~ 01.10	HN-531			FN-1189	
NOTE						
1500 E11	05. 1 ~ 12. 9	HN-452			FN-1261	
NE11 4WD	05. 1 ~ 12. 9	HN-452			FN-1264	
BASSARA						
2400 JU30, JNU30	99.11 ~ 01. 8	HN-531			FN-1193	

- NISSAN
- TOYOTA
(HINO)
- MAZDA
- ISUZU
- HONDA
- MITSUBISHI
- SUBARU
- SUZUKI
- DAIHATSU
- LEXUS
- INFINITY
- HYUNDAI
- KIA

NISSAN - 18

NISSAN

TOYOTA
(HINO)

MAZDA

ISUZU

HONDA

MITSUBISHI

SUBARU

SUZUKI

DAIHATSU

LEXUS

INFINITI

HYUNDAI

KIA

Model 車種形式	Year 年式	Front フロント		Rear リア		Parking パーキング
		Pad パッド	Shoe シュー	Pad パッド	Shoe シュー	Shoe シュー
BASSARA						
2500 JVU30, JVNU30	99.11 ~ 01. 8	HN-531			FN-1193	
JTU30, JTNU30	01. 8 ~ 03. 6	HN-531			FN-1193	
3000 JHU30	99.11 ~ 03. 6	HN-531			FN-1193	
VANETTE						
1200 JC22, VJC22	85. 9 ~ 94. 3	HN-149			FN-1170	
1500 VPJC22	85. 9 ~ 94. 3	FN-149			FN-1170	
KPJC22	85. 9 ~ 91. 6	HN-149			FN-1170	
PJC22	88.11 ~ 94. 3	HN-149			FN-1170	
PGJC22	88.11 ~ 94. 3	HN-149			FN-1170	
SS58VN	SINGLE TYRE 94. 4 ~ 95. 8	HN-211			FN-3348	
	DOUBLE TYRES 94. 4 ~ 95. 8	HN-211			FN-3351	
SE58TN	SINGLE TYRE 94. 4 ~ 95. 8	HN-211			FN-3348	
	DOUBLE TYRES 94. 4 ~ 95. 8	HN-211			FN-3351	
1800 SS88MN	94. 4 ~ 99. 7	HN-211			FN-3348	
SS88VN	SINGLE TYRE 95. 8 ~ 96.10	HN-211			FN-3348	
	DOUBLE TYRES 95. 8 ~ 96.10	HN-211			FN-3351	
SE88MN	94. 4 ~ 99. 7	HN-211			FN-3350	
SE88TN	SINGLE TYRE 95. 8 ~ 99. 7	HN-211			FN-3348	
	DOUBLE TYRES 95. 8 ~ 99. 7	HN-211			FN-3351	
SK82LN	99. 6 ~ 04. 3	HN-332			FN-3410	
	04. 3 ~ 10.10	HN-332			FN-3426	
SK82MN	99. 6 ~ 04. 3	HN-332			FN-3410	
	04. 3 ~ 10.10	HN-332			FN-3426	
SK82TN	99. 6 ~ 04. 3	HN-332			FN-3410	
	04. 3 ~ 10.10	HN-332			FN-3426	
SK82VN	99. 6 ~ 04. 3	HN-332			FN-3410	
	04. 3 ~ 10.10	HN-332			FN-3426	
VUJC22	95. 9 ~ 94. 3	HN-149			FN-1170	
VUJNC22	88. 9 ~ 94. 3	HN-176			FN-1170	
VUJNBC22	88. 9 ~ 91. 6	HN-176			FN-1170	
KUJC22	85. 9 ~ 91. 6	HN-149			FN-1170	
KMJNC22	88. 9 ~ 91. 6	HN-176			FN-1170	
KUJNC22	88. 9 ~ 94. 3	HN-176			FN-1170	
UJC22	88.11 ~ 94. 3	HN-149			FN-1170	
UGJC22	88.11 ~ 94. 3	HN-149			FN-1170	
FJNC22	90. 8 ~ 94. 3	HN-176			FN-1170	
UGJNC22	88.11 ~ 94. 3	HN-176			FN-1170	
2000 SKF2LN	03.12 ~ 04. 3	HN-332			FN-3410	
	04. 3 ~ 10.10	HN-332			FN-3426	
SKF2MN	03.12 ~ 04. 3	HN-332			FN-3410	
	04. 3 ~ 10.10	HN-332			FN-3426	
SKF2TN	03.12 ~ 04. 3	HN-332			FN-3410	
	04. 3 ~ 10.10	HN-332			FN-3426	
SKF2VN	03.12 ~ 04. 3	HN-332			FN-3410	

NISSAN - 19

Model 車種形式	Year 年式	Front フロント		Rear リア		Parking パーキング
		Pad パッド	Shoe シュー	Pad パッド	Shoe シュー	Shoe シュー
VANETTE						
2000 SKF2VN	04. 3 ~ 10.10	HN-332				FN-3426
2200 SS28VN	SINGLE TYRE	94. 4 ~ 99. 7	HN-211			FN-3348
	DOUBLE TYRES	94. 4 ~ 99. 7	HN-211			FN-3351
SE28MN		94. 4 ~ 99. 7	HN-211			FN-3350
SE28TN	SINGLE TYRE	94. 4 ~ 99. 7	HN-211			FN-3351
	DOUBLE TYRES	94. 4 ~ 99. 7	HN-211			FN-3351
SS28MN		94. 4 ~ 99. 7	HN-211			FN-3348
SK22LN		99. 6 ~ 03.12	HN-332			FN-3410
SK22MN		99. 6 ~ 03.12	HN-332			FN-3410
SK22TN		99. 6 ~ 03.12	HN-332			FN-3410
SK22VN		99. 6 ~ 03.12	HN-332			FN-3410
PULSAR						
1300 N14		90. 8 ~ 94.12	HN-226			FN-1185
1500 FN14	W/O ABS	90. 8 ~ 94.12	HN-226			FN-1185
	W/ ABS	90. 8 ~ 94.12	HN-226		HN-283	
FNN14	W/O ABS	90. 8 ~ 94.12	HN-226			FN-1170
	W/ ABS	90. 8 ~ 94.12	HN-226		HN-283	
FN15	W/O ABS	95. 1 ~ 00. 8	HN-356			FN-1185
	W/ ABS	95. 1 ~ 00. 8	HN-356		HN-357	
FNN15	W/O ABS	95. 1 ~ 00. 8	HN-356			FN-1170
	W/ ABS	95. 1 ~ 00. 8	HN-356		HN-283	
1600 EN14	W/O ABS	90. 8 ~ 94.12	HN-226			FN-1185
	W/ ABS	90. 8 ~ 94.12	HN-226		HN-283	
EN15	W/O ABS	95. 1 ~ 97. 9	HN-356			FN-1185
	W/ ABS	97. 9 ~ 00. 8	HN-356			FN-1167
JN15		95. 1 ~ 00. 8	HN-356		HN-357	
		97. 9 ~ 00. 8	HN-268		HN-224	
1700 SN14	W/O ABS	90. 8 ~ 94.12	HN-226			FN-1185
	W/ ABS	90. 8 ~ 94.12	HN-226		HN-283	
1800 HN14		90. 8 ~ 94.12	HN-199		HN-283	
HN15		95. 1 ~ 00. 8	HN-356		HN-357	
	3D HATCH-BACK 15INCH	95. 1 ~ 00. 8	HN-268		HN-224	
HNN15		96. 5 ~ 00. 8	HN-268		HN-224	
2000 RNN14		90. 8 ~ 00. 8	HN-268		HN-224	
SN15	W/O ABS	95. 1 ~ 00. 8	HN-356			FN-1185
	W/ ABS	95. 1 ~ 00. 8	HN-356		HN-357	
SNN15	W/O ABS	95. 1 ~ 00. 8	HN-356			FN-1170
	W/ ABS	95. 1 ~ 00. 8	HN-356		HN-283	
PINO						
660 HC24S		07. 1 ~	HN-523			FN-9967

- NISSAN
- TOYOTA
(HINO)
- MAZDA
- ISUZU
- HONDA
- MITSUBISHI
- SUBARU
- SUZUKI
- DAIHATSU
- LEXUS
- INFINITY
- HYUNDAI
- KIA

NISSAN - 20

- NISSAN
- TOYOTA
(HINO)
- MAZDA
- ISUZU
- HONDA
- MITSUBISHI
- SUBARU
- SUZUKI
- DAIHATSU
- LEXUS
- INFINITI
- HYUNDAI
- KIA

Model 車種形式	Year 年式	Front フロント		Rear リア		Parking パーキング
		Pad パッド	Shoe シュー	Pad パッド	Shoe シュー	Shoe シュー
FUGA						
2500 Y50	04.10 ~ 09. 8	HN-444		HN-466		
	09. 8 ~ 09.11	HN-444		HN-565		
Y51	09.11 ~	HN-444		HN-565		
3500 PY50, PNY50						
	04.10 ~	HN-444		HN-466		
	09. 8 ~ 09.11	HN-444		HN-565		
3700 KY51						
	09.11 ~	HN-444		HN-565		
370GT TYPE S	09.11 ~			HN-557		
KNY51	09.11 ~	HN-444		HN-565		
	09. 8	HN-444		HN-565		
4500 GY50	05. 8 ~	HN-444		HN-466		
FIGARO						
1000 FK10	91. 2 ~ 92. 4	HN-131			FN-1164	
FAIRLADY Z						
3000 Z32, GZ32	89. 7 ~ 98.10	HN-220		HN-221		
	98.10 ~ 00. 8	HN-358		HN-221		
GCZ32	89. 7 ~ 98.10	HN-220		HN-221		
	98.10 ~ 00. 8	HN-358		HN-221		
HZ32	92. 8 ~ 98.10	HN-220		HN-221		
3500 Z33						
COUPE, STANDARD BRAKE	02. 7 ~ 05. 9	HN-474		HN-466		
	05. 9 ~ 08.12	HN-444		HN-466		
VERSION S, VERSION ST	02. 7 ~ 08.12					
HZ33	ROADSTER, STANDARD BRAKE	03.10 ~ 05. 9	HN-474	HN-466		
		05. 9 ~ 08.12	HN-444	HN-466		
VERSION ST	03.10 ~ 08.12					
3700 Z34						
	08.12 ~ 09. 8	HN-444		HN-466		
	09. 8 ~	HN-444		HN-565		
VERSION S, ST	08.12 ~			HN-557		
HZ34	09.10 ~	HN-444		HN-565		
PRIMERA・PRIMERA WAGON						
1800 P10	W/O ABS	90. 2 ~ 95. 9	HN-188		FN-1167	
	W/ ABS	92. 9 ~ 95. 9	HN-176		HN-130	
P11	W/O ABS	95. 9 ~ 96. 8	HN-176		FN-1167	
	W/ ABS	95. 9 ~ 97. 9	HN-176		HN-224	
		97. 9 ~ 98. 9	HN-176		FN-1223	
QP11		98. 9 ~ 01. 1	HN-176		FN-1223	
WP11	WAGON	97. 9 ~ 98. 9	HN-176		HN-224	
QP12		02. 2 ~ 05.12	HN-504		HN-467	
2000 HP10, FHP10						
		90. 2 ~ 96.11	HN-176		HN-130	
HNP10		90.10 ~ 95. 9	HN-176		HN-224	
HP11		95. 9 ~ 01. 1	HN-176		HN-224	
TE-V		97. 9 ~ 01. 1	HN-201A		HN-224	

NISSAN - 21

Model 車種形式	Year 年式	Front フロント		Rear リア		Parking パーキング
		Pad パッド	Shoe シュー	Pad パッド	Shoe シュー	Shoe シュー
PRIMERA・PRIMERA WAGON						
2000 HNP11	95.9 ~ 97.9	HN-176		HN-224		
	97.9 ~ 01.1	HN-201A		HN-224		
WHP11 WAGON	97.9 ~ 01.1	HN-201A		HN-224		
WHNP11 WAGON	97.9 ~ 01.1	HN-201A		HN-224		
TP12	01.1 ~ 05.12	HN-504		HN-467		
4WD	01.1 ~ 05.12	HN-504		HN-466		
WTP12 WAGON	01.1 ~ 05.12	HN-504		HN-467		
WAGON 4WD	01.1 ~ 05.12	HN-504		HN-466		
WTNP12 WAGON	01.1 ~ 05.12	HN-504		HN-466		
HP12, WHP12	01.8 ~ 03.7	HN-504		HN-467		
TNP12	01.8 ~ 05.12	HN-504		HN-466		
2500 RP12, WRP12	01.1 ~ 05.12	HN-504		HN-467		
BLUEBIRD						
1500 FG10 SYLPHY	00.8 ~ 05.12	HN-435			FN-1167	
G11 SYLPHY	05.12 ~ 12.12	HN-452			FN-1267	
NG11 SYLPHY	05.12 ~ 12.12	HN-452			FN-1264	
1600 U12	87.9 ~ 91.8	HN-188			FN-1176	
U13	W/O ABS 91.9 ~ 95.11	HN-188			FN-1196	
	W/ ABS 91.9 ~ 95.11	HN-176		HN-224		
1800 EU12, TMU12	W/O ABS 89.10 ~ 91.8	HN-188			FN-1167	
	W/ ABS 89.10 ~ 91.8	HN-176		HN-130		
ENU12	89.10 ~ 91.8	HN-176		HN-130	FN-1170	
EU13	W/O ABS 91.9 ~ 95.11	HN-188			FN-1196	
	W/ ABS 91.9 ~ 95.11	HN-176		HN-224		
SUPER TOURING	92.8 ~ 95.11	HN-176		HN-224		
ENU13	W/O ABS 91.9 ~ 95.11	HN-176			FN-1198	
	W/ ABS 91.9 ~ 95.11	HN-176		HN-224		
EU14	W/O ABS 96.1 ~ 97.9	HN-176			FN-1167	
	W/ ABS 97.9 ~ 98.9	HN-176			FN-1223	
	W/ ABS 96.1 ~ 98.9	HN-176		HN-224		
ENU14	96.1 ~ 00.11	HN-176		HN-224		
	00.11 ~ 01.8	HN-176		HN-467		
QU14	98.9 ~ 01.8	HN-176			FN-1223	
	98.9 ~ 00.11	HN-176		HN-224		
	00.11 ~ 01.8	HN-176		HN-467		
QG10 SYLPHY	00.8 ~ 05.12	HN-435			FN-1167	
QNG10 SYLPHY 4WD	00.8 ~ 05.12	HN-435			FN-1170	
2000 SU12, TSU12	87.9 ~ 91.8	HN-188			FN-1167	
HU12, HNU12	89.10 ~ 91.8	HN-176		HN-130		
HNU12 TURBO	89.10 ~ 91.8	HN-245		HN-130		
HAU12	91.2 ~ 92.4	HN-176		HN-130		
HU13, HNU13	91.9 ~ 95.11	HN-176		HN-224		
HNU13 TURBO	91.9 ~ 95.11	HN-309		HN-224		
SU13	W/O ABS 91.9 ~ 95.11	HN-188			FN-1196	

- NISSAN
- TOYOTA (HINO)
- MAZDA
- ISUZU
- HONDA
- mitsubishi
- SUBARU
- SUZUKI
- DAIHATSU
- LEXUS
- INFINITY
- HYUNDAI
- KIA

NISSAN - 22

- NISSAN
- TOYOTA
(HINO)
- MAZDA
- ISUZU
- HONDA
- MITSUBISHI
- SUBARU
- SUZUKI
- DAIHATSU
- LEXUS
- INFINITI
- HYUNDAI
- KIA

Model 車種形式			Year 年式	Front フロント		Rear リア		Parking パーキング
				Pad パッド	Shoe シュー	Pad パッド	Shoe シュー	Shoe シュー
BLUEBIRD								
2000	SU13	W/ ABS	91. 9 ~ 95.11	HN-176		HN-224		
	SNU13	W/O ABS	91. 9 ~ 95.11	HN-176			FN-1198	
		W/ ABS	91. 9 ~ 95.11	HN-176		HN-224		
	HU14	W/O ABS	96. 1 ~ 97. 9	HN-176			FN-1167	
		W/O ABS	97. 9 ~ 01. 8	HN-176			FN-1223	
		W/ ABS	96. 1 ~ 01. 8	HN-176		HN-224		
	SSS		96. 1 ~ 00.11	HN-176		HN-224		
			00.11 ~ 01. 8	HN-176		HN-467		
	SSS-Z		97. 9 ~ 00.11	HN-201A		HN-224		
			00.11 ~ 01. 8	HN-201A		HN-467		
	HNU14		96. 1 ~ 00.11	HN-176		HN-224		
			00.11 ~ 01. 8	HN-176		HN-467		
	SU14	W/OUT ABS	96. 1 ~ 97. 9	HN-176			FN-1167	
		W/OUT ABS	97. 9 ~ 01. 6	HN-176			FN-1223	
		WITH ABS	96. 1 ~ 01. 6	HN-176		HN-224		
	FOR DRIVING TRAINING SCHOOL		96. 1 ~ 00.11	HN-176		HN-224		
			00.11 ~ 01. 8	HN-176		HN-467		
	TG10	SYLPHY	00. 8 ~ 05.12	HN-435			FN-1167	
	KG11	SYLPHY	05.12 ~ 12.12	HN-452			FN-1267	
2400	PU13		93. 8 ~ 95.11	HN-176		HN-224		
PRARIE・LIBERTY								
2000	M11		88. 9 ~ 95. 8	HN-176			FN-1170	
	NM11	4WD	W/O ABS	88. 9 ~ 95. 8	HN-176		FN-1170	
			W/ ABS	88. 9 ~ 95. 8	HN-176	HN-130		
	J8	W/O ABS	90. 9 ~ 95. 8	HN-245			FN-1170	
		W/ ABS	90. 9 ~ 95. 8	HN-245		HN-130		
	PM11	W/O ABS	95. 8 ~ 98.11	HN-245			FN-1170	
		W/ ABS	95. 8 ~ 98.11	HN-245		HN-224		
	PNM11		95. 8 ~ 98.11	HN-245		HN-224		
	PM12	WAGON	98.11 ~ 01. 5	HN-261			FN-1170	
	PNM12	WAGON	98.11 ~ 01. 5	HN-261			FN-1193	
	RM12		01. 5 ~ 04.12	HN-261			FN-1170	
	RNM12	4WD	01. 5 ~ 04.12	HN-261			FN-1193	
2400	HM11		92. 2 ~ 95. 8	HN-245			FN-1170	
	HNM11	W/O ABS	90. 9 ~ 95. 8	HN-245			FN-1170	
		W/ ABS	90. 9 ~ 95. 8	HN-245		HN-130		
PRESAGE								
2400	U30, NU30		98. 6 ~ 01. 8	HN-531			FN-1193	
2500	VU30, VNU30		98. 6 ~ 01. 8	HN-531			FN-1193	
	TU30, TNU30		01. 8 ~ 03. 7	HN-531			FN-1193	
	TU31, TNU31		03. 6 ~ 09. 8	HN-488		HN-466		
3000	HU30		98. 6 ~ 03. 7	HN-531			FN-1193	

NISSAN - 23

Model 車種形式	Year 年式	Front フロント		Rear リア		Parking パーキング
		Pad パッド	Shoe シュー	Pad パッド	Shoe シュー	Shoe シュー
PRESAGE						
3500 PU31, PNU31	03. 6 ~ 09. 8	HN-488		HN-466		
PRESIDENT						
4500 JHG50	90.10 ~ 02. 8					
JG50, PG50	92. 2 ~ 02. 8					
PHG50	92. 2 ~ 02. 8					
PGF50	03.10 ~ 10. 8	HN-444		HN-262		
PRESEA						
1500 R10	90. 6 ~ 95. 1	HN-226		HN-283	FN-1185	
R11	95. 1 ~ 97. 8	HN-356		HN-357	FN-1185	
	97. 8 ~ 00. 8	HN-356		HN-357	FN-1167	
1800 PR10	90. 6 ~ 95. 1	HN-226		HN-283	FN-1185	
PR11	95. 1 ~ 97. 8	HN-356		HN-357	FN-1185	
	97. 8 ~ 00. 8	HN-356		HN-357	FN-1167	
2000 HR10	90. 6 ~ 95. 1	HN-199		HN-283		
HR11	95. 1 ~ 97. 8	HN-356		HN-357	FN-1185	
	97. 8 ~ 00. 8	HN-356		HN-357		
MARCH						
1000 K10	84. 3 ~ 92. 1	HN-131			FN-1164	
EK10	88. 8 ~ 92. 1	HN-367			FN-1164	
K11	92. 1 ~ 97. 5	HN-131			FN-1204	
	97. 5 ~ 99.11	HN-410			FN-1204	
K11, WK11	99.11 ~ 02. 2	HN-435			FN-1204	
K12	02. 2 ~ 03. 7	HN-452			FN-1261	
1200 AK12	02. 2 ~ 10. 7	HN-452			FN-1261	
K13	10. 7 ~	HN-555				
NK13	10. 7 ~	HN-555			FN-1264	
1300 HK11	W/O ABS 92. 1 ~ 97. 5	HN-131			FN-1204	
	W/ ABS 92. 1 ~ 97. 5	HN-131				
HK11, FHK11	97. 5 ~ 99.11	HN-410			FN-1204	
CK11 CABRIOLET	97. 8 ~ 99.10	HN-410			FN-1204	
AK11, WAK11	99.11 ~ 02. 2	HN-435			FN-1204	
ANK11 4WD	99.11 ~ 02. 2	HN-435			FN-1198	
1400 BK12	02. 2 ~ 05. 8	HN-452			FN-1261	
BNK12 4WD	02. 9 ~ 05. 8	HN-452			FN-1198	
	05. 8 ~ 10. 7	HN-452			FN-1264	
1500 YK12	05. 8 ~ 10. 7	HN-452			FN-1261	
K13	13.12 ~	HN-555				
MAXIMA						
3000 J30	88.10 ~ 91. 8	HN-201A		HN-130		

- NISSAN
- TOYOTA (HINO)
- MAZDA
- ISUZU
- HONDA
- MITSUBISHI
- SUBARU
- SUZUKI
- DAIHATSU
- LEXUS
- INFINITY
- HYUNDAI
- KIA

NISSAN - 24

- NISSAN
- TOYOTA
(HINO)
- MAZDA
- ISUZU
- HONDA
- MITSUBISHI
- SUBARU
- SUZUKI
- DAIHATSU
- LEXUS
- INFINITI
- HYUNDAI
- KIA

Model 車種形式	Year 年式	Front フロント		Rear リア		Parking パーキング
		Pad パッド	Shoe シュー	Pad パッド	Shoe シュー	Shoe シュー
MAXIMA						
PJ30	91. 8 ~ 94. 2	HN-201A		HN-224		
MISTRAL						
2700 R20, KR20	94. 2 ~ 98. 7	HN-137			FN-1174	
MURANO						
2500 TZ50	04. 9 ~ 08. 9	HN-554		HN-466		
TNZ51, TZ50, TZ51	08. 9 ~ 11. 6	HN-554		HN-466		
TZ51, TNZ51	11. 6 ~ 15. 3	HN-444		HN-565		
3500 PZ50, PNZ50	04. 9 ~ 08. 9	HN-554		HN-466		
PNZ51	08. 9 ~ 11. 6	HN-554		HN-466		
	11. 6 ~ 15. 3	HN-444		HN-565		
MOCO						
660 MG21S	02. 4 ~ 03. 8	HN-426			FN-9959	
	03. 8 ~ 04.12	HN-426			FN-9967	
W/O TURBO	04.12 ~ 06. 2	HN-566			FN-9967	
TURBO	04.12 ~ 06. 2	HN-426			FN-9967	
MG22S	06. 2 ~ 11. 2	HN-523			FN-9967	
MG33S	11. 2 ~ 16. 5	HN-566				
RASHEEN						
1500 RFNB14	94.12 ~ 00. 8	HN-356		HN-283	FN-1170	
1800 RHNB14	97. 1 ~ 00. 8	HN-268		HN-224		
2000 RKNB14	98. 4 ~ 00. 8	HN-268		HN-224		
LAFESTA						
2000 B30, NB30	04.12 ~ 12. 5	HN-474			FN-1264	
VANETTE LARGO						
1500 EPC22	86. 5 ~ 93. 4	HN-149			FN-1170	
1800 KHGC22	86. 5 ~ 93. 4	HN-149			FN-1170	
KHGNC22	89. 6 ~ 93. 4	HN-105			FN-1174	
2000 VUGJC22	86. 5 ~ 93. 4	HN-149			FN-1170	
KMGC22	86. 5 ~ 93. 4	HN-149			FN-1170	
KUGC22	86. 5 ~ 93. 4	HN-149			FN-1170	
VUGJNC22	86.11 ~ 93. 4	HN-105			FN-1174	
KUMGNC22	86.11 ~ 93. 4	HN-105			FN-1174	
KUGNC22	86.11 ~ 93. 4	HN-105			FN-1174	
LARGO						
2000 VW30	93. 5 ~ 99. 6	HN-245			FN-1193	
VNW30	SEVEN SEATER 93. 5 ~ 99. 6	HN-245			FN-1193	
TURBO	EIGHT SEATER 94. 4 ~ 99. 6	HN-344			FN-1193	

NISSAN - 25

Model 車種形式	Year 年式	Front フロント		Rear リア		Parking パーキング
		Pad パッド	Shoe シュー	Pad パッド	Shoe シュー	Shoe シュー
LARGO						
2400 W30, CW30	93. 5 ~ 99. 6	HN-245				FN-1193
NW30, NCW30	93. 5 ~ 99. 6	HN-344				FN-1193
ROOX						
660 ML21S	09.12 ~ 13. 3	HN-523				FN-9967
R'NESSA						
2000 N30	97.10 ~ 98.11	HN-261				FN-1170
	98.11 ~ 00. 1	HN-261				
	00. 1 ~ 01. 7	HN-261				FN-1193
NN30	97.10 ~ 01. 7	HN-531				FN-1193
2400 PNN30	97.10 ~ 01. 7	HN-531				FN-1193
EVN30 ELECTRIC CAR	98. 5 ~ 00.11	HN-531				FN-1193
LEOPARD						
2000 GF31	86. 2 ~ 91.12	HN-105		HN-200		
JY33	97. 1 ~ 99. 6	HN-261		HN-270		
2500 JENY33	97.10 ~ 99. 6	HN-261		HN-262		
JMY33	97.10 ~ 99. 6	HN-261		HN-270		
3000 UF31	86. 2 ~ 91.12	HN-105		HN-200		
JPY32 J.FERIE	92. 6 ~ 95.12	HN-261		HN-262		
JPY33	96. 3 ~ 97.10	HN-261		HN-270		
JHY33 XR	96. 3 ~ 99. 6	HN-261		HN-270		
XV, XV-G	96. 3 ~ 99. 6	HN-261		HN-262		
JHBY33	96. 3 ~ 99. 6	HN-261		HN-262		
4100 JGBY32 J.FERIE	92. 6 ~ 95.12	HN-261		HN-262		
LAUREL						
1800 FJC32	84.10 ~ 93. 8	HN-105				FN-1170
FC33	88.12 ~ 93. 1	HN-199				FN-1170
2000 HC33	W/O ABS 90. 4 ~ 93. 1	HN-199		HN-270		
	W/ ABS 90. 4 ~ 93. 1	HN-176		HN-270		
TURBO	90. 4 ~ 93. 1	HN-201A		HN-270		
HCC33	90. 4 ~ 93. 1	HN-176		HN-270		
TURBO	90. 4 ~ 93. 1	HN-201A		HN-270		
HC34	93. 1 ~ 97. 6	HN-317		HN-270		
HC35	97. 6 ~ 02. 8	HN-201A		HN-422		
2500 EC33, ECC33	91.10 ~ 93. 1	HN-201A		HN-270		
GC34, GCC34	93. 1 ~ 97. 6	HN-201A		HN-270		
TURBO	94. 1 ~ 97. 6	HN-309		HN-270		
GNC34	94. 9 ~ 97. 6	HN-309		HN-270		
GC35, GCC35	97. 6 ~ 02. 8	HN-201A		HN-422		
TURBO	97. 6 ~ 98. 9	HN-309		HN-422		

- NISSAN
- TOYOTA
(HINO)
- MAZDA
- ISUZU
- HONDA
- MITSUBISHI
- SUBARU
- SUZUKI
- DAIHATSU
- LEXUS
- INFINITY
- HYUNDAI
- KIA

TOYOTA - 1

Model 車種形式	Year 年式	Front フロント		Rear リア		Parking パーキング
		Pad パッド	Shoe シュー	Pad パッド	Shoe シュー	Shoe シュー
bb						
1300 NCP30	00. 1 ~ 04.11	HN-472				FN-2342
	04.11 ~ 05.12	HN-540				FN-2342
QNC20	06. 1 ~ 16. 7	HN-443				FN-2397
QNC25 4WD	06. 1 ~ 16. 7	HN-443				FN-0041
1500 NCP31, 35						
	00. 1 ~ 04.11	HN-472				FN-2342
	04.11 ~ 05.12	HN-540				FN-2342
NCP34 OPEN DECK	01. 6 ~ 03. 3	HN-472				FN-2342
QNC21	06. 1 ~ 16. 7	HN-443				FN-2397
iQ						
1000 KGJ10	08.11 ~ 16. 3	HN-577		HN-519		
1300 NGJ10	08.11 ~ 16. 3	HN-577		HN-519		
ist						
1300 NCP60	02. 4 ~ 07. 7	HN-472				FN-2342
1500 NCP61						
NCP65 4WD	02. 4 ~ 07. 7	HN-472		HN-454		FN-2342
NCP110	07. 7 ~ 16. 4	HN-524				FN-2389
NCP115 4WD	07. 7 ~ 16. 4	HN-524		HN-519		
1800 ZSP110	07. 7 ~ 16. 4	HN-524				FN-2389
M R - 2						
2000 SW20	91.12 ~ 99. 8	HN-267		HN-496		
M R - S						
1800 ZZW30	99.10 ~ 07. 7	HN-472		HN-496		
R A V - 4						
1800 ZCA25W						
	00. 5 ~ 03. 7	HN-447				FN-2333
	03. 7 ~ 05.11	HN-447				
ZCA26W	00. 5 ~ 02. 8	HN-447				FN-2333
	02. 8 ~ 05.11	HN-447				
2000 SXA10G, 11G						
SXA10W, 11W	96. 8 ~ 00. 5	HN-322		HN-424		FN-2333
SXA15G, 16G FF 2WD	97. 9 ~ 00. 5	HN-322				FN-2333
ACA20W	00. 5 ~ 03. 7	HN-447		HN-424		FN-2333
	03. 7 ~ 05.11	HN-447		HN-424		
ACA21W	00. 5 ~ 02. 8	HN-447		HN-424		FN-2333
	02. 8 ~ 05.11	HN-447		HN-424		
2400 ACA31W, 36W	05.11 ~ 16. 7	HN-530		HN-522		
Will CYPHA						
1300 NCP70	02. 9 ~ 05. 7	HN-472				FN-2342

- NISSAN
- TOYOTA (HINO)
- MAZDA
- ISUZU
- HONDA
- MITSUBISHI
- SUBARU
- SUZUKI
- DAIHATSU
- LEXUS
- INFINITY
- HYUNDAI
- KIA

TOYOTA - 2

- NISSAN
- TOYOTA**
(HINO)
- MAZDA
- ISUZU
- HONDA
- MITSUBISHI
- SUBARU
- SUZUKI
- DAIHATSU
- LEXUS
- INFINITY
- HYUNDAI
- KIA

Model 車種形式	Year 年式	Front フロント		Rear リア		Parking パーキング
		Pad パッド	Shoe シュー	Pad パッド	Shoe シュー	Shoe シュー
Will CYPHA						
1500 NCP75 4WD	02. 9 ~ 05. 7	HN-472			FN-2342	
Will Vi						
1300 NCP19	00. 1 ~ 01.12	HN-472			FN-2350	
Will VS						
1500 NZE127	02. 1 ~ 04. 4	HN-472			FN-2342	
1800 ZZE127	01. 4 ~ 04. 4	HN-472		HN-454		
ZZE128	01. 4 ~ 04. 4	HN-430		HN-454		
ZZE129 4WD	01. 4 ~ 04. 4	HN-472			FN-2342	
ISIS						
1800 ZNM10G, 10W	04. 9 ~ 09. 9	HN-479			FN-2371	
ZGM10G, 10W	09. 9 ~	HN-479			FN-2371	
ZGM15G, 15W	09. 9 ~	HN-479		HN-449		
2000 ANM10G, 10W	04. 9 ~ 09. 9	HN-479		HN-449		
ANM15G, 15W	04. 9 ~ 09. 9	HN-479		HN-449		
ZGM11G, 11W	09. 9 ~	HN-479		HN-449		
AVALON						
3000 MCX10	95. 3 ~ 97. 9	HN-228		HN-323		
	97. 9 ~ 00. 2	HN-401		HN-323		
AVENSIS						
2000 AZT250, 255	03.10 ~ 08.10			HN-528		
AZT250W, 255W WAGON	03.10 ~ 08.10			HN-528		
2400 AZT251	05. 6 ~ 08.10			HN-528		
AZT251W WAGON	05. 6 ~ 08.10			HN-528		
ARISTO						
3000 JZS147 Q	91.10 ~ 97. 8	HN-228		HN-363		FN-2392
V. TURBO	93. 8 ~ 97. 8	HN-324		HN-363		FN-2392
JZS160, 161	97. 8 ~ 04.11	HN-324		HN-421		
4000 UZS143	92.10 ~ 97. 8	HN-324		HN-363		
ALTEZZA						
2000 SXE10, GXE10 17inch	98.10 ~ 05. 7	HN-324		HN-421		
15inch	98.10 ~ 01. 5	HN-228		HN-421		
	01. 5 ~ 05. 7	HN-442		HN-421		
GXE10W GITA 17inch	01. 6 ~ 05. 7	HN-324		HN-421		
GITA 15inch	01. 6 ~ 05. 7	HN-442		HN-421		
GXE15W	02. 1 ~ 05. 7	HN-324		HN-421		
	02. 1 ~ 03. 8	HN-228		HN-421		
3000 JCE10W, 15W GITA	01. 6 ~ 05. 7	HN-324		HN-421		

TOYOTA - 3

Model 車種形式	Year 年式	Front フロント		Rear リア		Parking パーキング
		Pad パッド	Shoe シュー	Pad パッド	Shoe シュー	Shoe シュー
ALPHARD・VELLFIRE						
2400 ANH10W, 15W	02. 5 ~ 08. 5	HN-480		HN-449		FN-2392
ATH10W HYBRID	03. 7 ~ 08. 5	HN-480		HN-449		FN-2392
ANH20W, 25W	08. 5 ~ 15. 1	HN-527		HN-528		FN-2392
ATH20W HYBRID	11.11 ~ 15. 1	HN-527		HN-528		
2500 AGH30W, AGH35W, AYH30W	15. 1 ~					
3000 MNH10W, 15W	02. 5 ~ 08. 5	HN-480		HN-449		FN-2392
3500 GGH20W, 25W	08. 5 ~ 15. 1	HN-527		HN-528		
GGH30W, GGH35W	15. 1 ~	HN-527				
IPSUM						
2000 SXM10G, 15G	96. 5 ~ 01. 5	HN-322			FN-2339	
2200 CXM10G	97. 9 ~ 01. 5	HN-322			FN-2339	
2400 ACM21W, 26W	01. 5 ~ 09.12	HN-470		HN-449		
VANGUARD						
2400 ACA33W, 38W	07. 8 ~ 13.11	HN-530		HN-522		
3500 GSA33W	07. 8 ~ 13.11	HN-530		HN-522		
WISH						
1800 ZNE10G	03. 1 ~ 09.03	HN-479		HN-458	FN-2358	
ZNE14G	03. 1 ~ 09.03	HN-479		HN-458		
ZGE20G	09.03 ~	HN-524			FN-2389	
ZGE20W	09.03 ~	HN-524		HN-458		
ZGE25G, W	09.03 ~	HN-524		HN-458		
2000 ANE10G, 11W	03. 4 ~ 09.03	HN-479		HN-458		
ZGE21G, 22W	09. 3 ~	HN-524		HN-458		
VITZ						
1000 SCP10	99. 1 ~ 05. 1	HN-471			FN-2350	
KSP90	05. 2 ~ 10.12	HN-508			FN-2383	
1300 SCP13	02.12 ~ 05. 1	HN-471			FN-2350	
SCP90	05. 2 ~ 10.12	HN-508			FN-2383	
NCP15 4WD	99. 8 ~ 05. 1	HN-471			FN-2342	
NCP10	99. 9 ~ 05. 1	HN-471			FN-2350	
NCP95 RS	00.10 ~ 05. 1	HN-472		HN-454		
NCP95	05. 2 ~ 10.12	HN-508			FN-2383	
1500 NCP13 RS	00.10 ~ 05. 1	HN-472		HN-454		
NCP91 X	05. 2 ~ 10.12	HN-508			FN-2383	
NCP91 RS	05. 2 ~ 10.12	HN-518		HN-519		

- NISSAN
- TOYOTA (HINO)
- MAZDA
- ISUZU
- HONDA
- MITSUBISHI
- SUBARU
- SUZUKI
- DAIHATSU
- LEXUS
- INFINITY
- HYUNDAI
- KIA

TOYOTA - 4

- NISSAN
- TOYOTA**
(HINO)
- MAZDA
- ISUZU
- HONDA
- MITSUBISHI
- SUBARU
- SUZUKI
- DAIHATSU
- LEXUS
- INFINITI
- HYUNDAI
- KIA

Model 車種形式	Year 年式	Front フロント		Rear リア		Parking パーキング
		Pad パッド	Shoe シュー	Pad パッド	Shoe シュー	Shoe シュー
WINDOM						
2500 VCV11	93. 8 ~ 96. 8	HN-228		HN-321		
MCV21	96. 8 ~ 99. 8	HN-401		HN-321		
MCV21	99. 8 ~ 01. 7	HN-401		HN-431		
3000 VCV10	91.10 ~ 96. 8	HN-228		HN-321		
MCV20	96. 8 ~ 99. 8	HN-401		HN-321		
	99. 8 ~ 01. 7	HN-401		HN-431		
MCV30	01. 7 ~ 06. 2	HN-480		HN-458		
VEROSSA						
2000 GX110	01. 6 ~ 04. 4	HN-442		HN-421		
GX115 4WD	01. 6 ~ 04. 4	HN-228		HN-421		
2500 JZX110	01. 6 ~ 04. 4	HN-442		HN-421		
TURBO	01. 6 ~ 04. 4	HN-324		HN-421		
VOLIZ						
1800 ZZE136	02. 5 ~ 04. 2	HN-470				
ZZE137	02. 5 ~ 04. 2	HN-470		HN-454		
ZZE138	02. 5 ~ 04. 2	HN-470			FN-2358	
ESTIMA						
2200 CXR10G	92. 1 ~ 93. 8	HN-273			FN-2252	
W/O ABS	93. 8 ~ 94. 5	HN-399			FN-2252	
W/O ABS	94. 5 ~ 96. 8	HN-399			FN-2335A	
W/ ABS	93. 8 ~ 95. 1	HN-399		HN-274		
W/ ABS	95. 1 ~ 96. 8	HN-385		HN-274		
	96. 8 ~ 99.12	HN-404		HN-274		
CXR11G	92. 1 ~ 93. 8	HN-273		HN-274	FN-2252	
W/O ABS	93. 8 ~ 94. 5	HN-399		HN-274	FN-2252	
W/O ABS	94. 5 ~ 96. 8	HN-399		HN-274	FN-2335	
W/ ABS	95. 1 ~ 96. 8	HN-385		HN-274		
	96. 8 ~ 99.12	HN-404		HN-274		
CXR20G	92. 1 ~ 93. 8	HN-273			FN-2252	
W/O ABS	93. 8 ~ 94. 5	HN-399			FN-2252	
W/O ABS	94. 5 ~ 96. 8	HN-399			FN-2335A	
W/ ABS	93. 8 ~ 95. 1	HN-399		HN-274		
W/ ABS	95. 1 ~ 96. 8	HN-385		HN-274		
	96. 8 ~ 99.12	HN-404		HN-274		
CXR21G	92. 1 ~ 93. 8	HN-273		HN-274	FN-2252	
W/O ABS	93. 8 ~ 94. 5	HN-399		HN-274	FN-2252	
W/O ABS	94. 5 ~ 96. 8	HN-399		HN-274	FN-2335	
W/ ABS	95. 1 ~ 96. 8	HN-385		HN-274		
	96. 8 ~ 99.12	HN-404		HN-274		
2400 TCR10G	92. 1 ~ 93. 8	HN-273			FN-2252	
W/O ABS	93. 8 ~ 94. 5	HN-399			FN-2252	
W/O ABS	94. 5 ~ 96. 8	HN-399			FN-2335A	
W/ ABS	93. 8 ~ 95. 1	HN-399		HN-274		FN-2392

TOYOTA - 5

Model 車種形式	Year 年式	Front フロント		Rear リア		Parking パーキング
		Pad パッド	Shoe シュー	Pad パッド	Shoe シュー	Shoe シュー
ESTIMA						
2400 TCR10G	W/ ABS	95. 1 ~ 96. 8	HN-385		HN-274	FN-2392
		96. 8 ~ 99.12	HN-404		HN-274	FN-2392
TCR10W	W/O ABS	93. 2 ~ 96. 8	HN-385		HN-274	FN-2392
	W/ ABS	93. 2 ~ 96. 8	HN-399		HN-274	FN-2392
TCR10W		96. 8 ~ 99.12	HN-404		HN-274	FN-2392
TCR11G		92. 1 ~ 93. 8	HN-273		HN-274	FN-2252
	W/O ABS	93. 8 ~ 94. 5	HN-399			FN-2252
	W/O ABS	94. 5 ~ 96. 8	HN-399			FN-2335
	W/ ABS	95. 1 ~ 96. 8	HN-385		HN-274	FN-2392
		96. 8 ~ 99.12	HN-404		HN-274	FN-2392
TCR11W		90. 5 ~ 92. 9	HN-273		HN-274	FN-2392
		92. 9 ~ 96. 8	HN-399		HN-274	FN-2392
		96. 8 ~ 99.12	HN-404		HN-274	FN-2392
TCR20G		92. 1 ~ 93. 8	HN-273			FN-2252
	W/O ABS	93. 8 ~ 94. 5	HN-399			FN-2252
	W/O ABS	94. 5 ~ 96. 8	HN-399			FN-2335A
	W/ ABS	93. 8 ~ 95. 1	HN-399		HN-274	FN-2392
	W/ ABS	95. 1 ~ 96. 8	HN-385		HN-274	FN-2392
		96. 8 ~ 99.12	HN-404		HN-274	FN-2392
TCR20W	W/O ABS	93. 2 ~ 96. 8	HN-385		HN-274	FN-2392
	W/ ABS	93. 2 ~ 96. 8	HN-399		HN-274	FN-2392
		96. 8 ~ 99.12	HN-404		HN-274	FN-2392
TCR21G		92. 1 ~ 93. 8	HN-273			FN-2252
	W/O ABS	93. 8 ~ 94. 5	HN-399			FN-2252
	W/O ABS	94. 5 ~ 96. 8	HN-399			FN-2335
	W/ ABS	95. 1 ~ 96. 8	HN-385		HN-274	FN-2392
		96. 8 ~ 99.12	HN-404		HN-274	FN-2392
TCR21W		90. 5 ~ 92. 9	HN-273		HN-274	FN-2392
		92. 9 ~ 96. 8	HN-399		HN-274	FN-2392
		96. 8 ~ 99.12	HN-404		HN-274	FN-2392
ACR30W, 40W		00. 2 ~ 03. 4	HN-448		HN-449	FN-2392
		03. 4 ~ 06. 1	HN-480		HN-449	FN-2392
AHR10W HYBRID		01. 5 ~ 03. 8	HN-448		HN-449	
		03. 8 ~ 06. 1	HN-470		HN-449	
AHR20W HYBRID		06. 1 ~	HN-527		HN-528	
ACR50W, 55W		06. 1 ~	HN-527		HN-528	
3000 MCR30W, 40W						
		99.12 ~ 03. 4	HN-448		HN-449	
		03. 4 ~ 06. 1	HN-480		HN-449	
3500 GSR50W, 55W						
		06. 1 ~	HN-527		HN-528	
OPA						
1800 ZCT10 A		00. 4 ~ 05. 2	HN-472			FN-2342
	I (SPECIFOR CARS WITH NO REAR DISC)	02. 5 ~ 05. 2	HN-430		HN-431	
ZCT15		00. 4 ~ 05. 2	HN-430		HN-431	FN-2358
2000 ACT10 A						
	I	00. 8 ~ 05. 2	HN-472			FN-2358
		00. 8 ~ 05. 2	HN-430		HN-431	FN-2358

- NISSAN
- TOYOTA (HINO)
- MAZDA
- ISUZU
- HONDA
- MITSUBISHI
- SUBARU
- SUZUKI
- DAIHATSU
- LEXUS
- INFINITI
- HYUNDAI
- KIA

TOYOTA - 6

- NISSAN
- TOYOTA**
(HINO)
- MAZDA
- ISUZU
- HONDA
- MITSUBISHI
- SUBARU
- SUZUKI
- DAIHATSU
- LEXUS
- INFINITI
- HYUNDAI
- KIA

Model 車種形式	Year 年式	Front フロント		Rear リア		Parking パーキング
		Pad パッド	Shoe シュー	Pad パッド	Shoe シュー	Shoe シュー
AURIS						
1500 NZE151H	06.10 ~ 12. 8	HN-524		HN-519		
NZE154H 4WD	06.10 ~ 12. 8	HN-524		HN-519		
1800 ZRE152H	06.10 ~ 12. 8	HN-524		HN-519		
ZRE154H 4WD	06.10 ~ 12. 8	HN-524		HN-519		
GAIA						
2000 SXM10G, 15G	98. 5 ~ 01. 4	HN-511			FN-2339	
SXM15G	01. 4 ~ 02. 8	HN-401			FN-2339	
ACM10G, 15G	01. 4 ~ 04. 9	HN-401			FN-2339	
2200 CXM10G	98. 5 ~ 01. 4	HN-511			FN-2339	
	01. 4 ~ 04. 9	HN-401			FN-2339	
GRACIA						
2200 SXV20, 20W	96.12 ~ 99. 8	HN-322		HN-321		
	99. 8 ~ 01. 9	HN-322		HN-431		
SXV25, 25W	97. 6 ~ 01. 9	HN-401		HN-321		
2500 MCV21, 21W	96.12 ~ 99. 8	HN-401		HN-321		
	99. 8 ~ 01. 9	HN-401		HN-431		
MCV25W	97. 6 ~ 01. 9	HN-401		HN-321		
CAMRY・VISTA						
1800 SV30	90. 7 ~ 94. 6	HN-259			FN-2285	
SV40	94. 6 ~ 98. 6	HN-322			FN-2285	
2000 CV30	90. 7 ~ 94. 6	HN-259			FN-2285	
SV32, 33 VE, VX, ZX	90. 7 ~ 94. 6	HN-259		HN-321		
GT, TOURING PG	90. 7 ~ 94. 6	HN-260		HN-321		
SV35	90. 7 ~ 94. 6	HN-259		HN-321		
SV41, 42, 43	94. 6 ~ 98. 6	HN-322		HN-321		
VZV30, 31	90. 7 ~ 92. 6	HN-260		HN-321		
2200 CV40	W/O ABS 94. 6 ~ 98. 6	HN-322			FN-2285	
	W/ ABS 94. 6 ~ 98. 6	HN-322		HN-321		
CV43	95. 1 ~ 98. 6	HN-322		HN-321		
2400 ACV30	01. 9 ~ 06. 1	HN-479		HN-458		
ACV35	01. 9 ~ 06. 1	HN-479		HN-321		
ACV40	06. 1 ~ 11. 9	HN-521		HN-522		
ACV45	06. 1 ~ 11. 9	HN-521		HN-458		
AVV50	11. 9 ~	HN-521		HN-522		
2500 VZV32, 33	91. 5 ~ 94. 6	HN-260		HN-321		
CARINA						
1500 AT170, AT170G	88. 5 ~ 92.11	HN-077C			FN-2285	
AT192 SG	92. 8 ~ 96. 8	HN-077C			FN-2285	

TOYOTA - 7

Model 車種形式			Year 年式	Front フロント		Rear リア		Parking パーキング
				Pad パッド	Shoe シュー	Pad パッド	Shoe シュー	Shoe シュー
CARINA								
1500	AT192	SX	92. 8 ~ 96. 8	HN-322			FN-2285	
	AT212	14inch WHEEL	96. 8 ~ 01.12	HN-322			FN-2311	
		13inch WHEEL	97.11 ~ 01.12	HN-077C			FN-2311	
	ET176V		88. 5 ~ 92.11	HN-077C			FN-2285	
1600	AT171	S LIMITED	88. 5 ~ 90. 5	HN-077C			FN-2285	
		S LIMITED	90. 5 ~ 92. 8	HN-281			FN-2285	
		G LIMITED	88. 5 ~ 92. 8	HN-281		HN-321		
	AT175		88. 8 ~ 92. 8	HN-281		HN-321		
	AT190	SGI	92. 8 ~ 96. 8	HN-077C			FN-2285	
		SXI	92. 8 ~ 96. 8	HN-322			FN-2285	
	AT210		96. 8 ~ 98. 8	HN-322		HN-321		
			98. 8 ~ 01.12	HN-267		HN-321		
1800	AT191	SGI	94. 8 ~ 96. 8	HN-077C			FN-2285	
		SXI , SEEXT	94. 8 ~ 96. 8	HN-322			FN-2285	
		SLTD	94. 8 ~ 96. 8	HN-322		HN-321		
	AT211		96. 8 ~ 01.12	HN-322			FN-2311	
	ST170, 170G		88. 5 ~ 92.11	HN-077C			FN-2285	
	ST190		92. 8 ~ 94. 8	HN-322			FN-2285	
		SL	92. 8 ~ 94. 8	HN-322		HN-321		
2000	CT170		88. 5 ~ 92.11	HN-077C			FN-2285	
	CT170G		90. 5 ~ 92.11	HN-077C			FN-2285	
	CT176V		88. 5 ~ 92.11	HN-077C			FN-2285	
	CT190		92. 8 ~ 96. 8	HN-322			FN-2285	
	CT195		92. 8 ~ 96. 8	HN-322		HN-321		
	CT210		96. 8 ~ 98. 8	HN-322			FN-2311	
	CT215		96. 8 ~ 98. 8	HN-322			FN-2338	
	ST195		92. 8 ~ 96. 8	HN-322		HN-321		
	ST215		96. 8 ~ 01.12	HN-322			FN-2338	
2200	CT211		98. 8 ~ 01.12	HN-322			FN-2311	
	CT216		98. 8 ~ 01.12	HN-322			FN-2338	
CARINA ED								
1800	ST180, 181		89. 9 ~ 91. 8	HN-077C			FN-2285	
			91. 8 ~ 93. 9	HN-281			FN-2285	
	ST200, 201		93. 9 ~ 98. 4	HN-322			FN-2285	
2000	ST182, 183		89. 9 ~ 91. 8	HN-281		HN-321		
	ST202	SLTD, X	93. 9 ~ 98. 4	HN-322		HN-321		
		GLTD	93. 9 ~ 98. 4	HN-228		HN-321		
		GLTD (SS SUSP.)	93. 9 ~ 98. 4	HN-362		HN-321		
	ST203		93. 9 ~ 97.12	HN-322		HN-321		
	ST205		94. 5 ~ 98. 4	HN-362		HN-321		
CALDINA								
1500	ET196V		92.11 ~ 02. 6	HN-077C			FN-2285	

- NISSAN
- TOYOTA (HINO)
- MAZDA
- ISUZU
- HONDA
- MITSUBISHI
- SUBARU
- SUZUKI
- DAIHATSU
- LEXUS
- INFINITY
- HYUNDAI
- KIA

TOYOTA - 8

- NISSAN
- TOYOTA**
(HINO)
- MAZDA
- ISUZU
- HONDA
- MITSUBISHI
- SUBARU
- SUZUKI
- DAIHATSU
- LEXUS
- INFINITI
- HYUNDAI
- KIA

Model 車種形式	Year 年式	Front フロント		Rear リア		Parking パーキング
		Pad パッド	Shoe シュー	Pad パッド	Shoe シュー	Shoe シュー
CALDINA						
1800 ST190G	92.11 ~ 96. 1	HN-322			FN-2285	
AT191G	96. 1 ~ 97. 8	HN-322			FN-2311	
AT211G	97. 8 ~ 02. 9	HN-322			FN-2311	
ZZT241W	02. 9 ~ 07. 6	HN-430		HN-431		
2000						
CT190G	92.11 ~ 97. 8	HN-322			FN-2285	
DTB	96. 1 ~ 97. 8	HN-322			FN-2311	
CT196V	92.11 ~ 98. 5	HN-077C			FN-2285	
CT198V	92.11 ~ 98. 5	HN-077C			FN-2313	
ST191G	92.11 ~ 97. 8	HN-322		HN-321	FN-2311	
ST195G	92.11 ~ 97. 8	HN-322		HN-321	FN-2338	
ST198V	99. 8 ~ 02. 6	HN-077C			FN-2203	
ST210G E, G	97. 8 ~ 02. 9	HN-322			FN-2311	
GT	97. 8 ~ 02. 9	HN-267		HN-321		
ST215G E, G	97. 8 ~ 02. 9	HN-322			FN-2338	
GT	97. 8 ~ 02. 9	HN-267		HN-321		
ST215W GT-T	97. 8 ~ 02. 9	HN-267		HN-321		
AZT241W	02. 9 ~ 07. 6	HN-430		HN-431		
AZT246W	02. 9 ~ 07. 6	HN-430		HN-431		
ST246W	02. 9 ~ 07. 6	HN-480		HN-458		
2200						
CT216G	97. 8 ~ 02. 9	HN-322			FN-2338	
CT197V	98. 5 ~ 02. 6	HN-077C			FN-2285	
CT199V	98. 5 ~ 99. 8	HN-077C			FN-2313	
	99. 8 ~ 02. 6	HN-077C			FN-2203	
CURREN						
1800 ST208	95. 9 ~ 98. 7	HN-322			FN-2285	
2000						
ST206 FS, XS	94. 2 ~ 98. 7	HN-322		HN-321		
ZS	94. 2 ~ 98. 7	HN-228		HN-321		
ZS (SS SUSP.)	94. 2 ~ 98. 7	HN-362		HN-321		
ST207	94. 2 ~ 97.12	HN-322		HN-321		
COROLLA						
1300						
EE90	87. 5 ~ 91. 6	HN-077C			FN-2311	
EE96V, 97G	87. 8 ~ 91. 9	HN-077C			FN-2311	
EE101	91. 6 ~ 95. 5	HN-077C			FN-2311	
EE102V	94. 1 ~ 02. 6	HN-077C			FN-2311	
EE106V	91. 9 ~ 94. 1	HN-077C			FN-2311	
EE111	95. 5 ~ 00. 8	HN-077C			FN-2311	
NZE120	00. 8 ~ 06.10	HN-472			FN-2342	
1500						
AE91	89. 5 ~ 92. 5	HN-077C		HN-136	FN-2311	
AE100	91. 6 ~ 95. 5	HN-077C			FN-2311	
AE100G	95. 5 ~ 00. 8	HN-077C			FN-2311	
EE98V	87. 8 ~ 91. 9	HN-077C			FN-2311	
EE103V	94. 1 ~ 02. 6	HN-077C			FN-2311	
EE104G	94. 1 ~ 02. 6	HN-077C			FN-2311	

TOYOTA - 9

Model 車種形式	Year 年式	Front フロント		Rear リア		Parking パーキング
		Pad パッド	Shoe シュー	Pad パッド	Shoe シュー	Shoe シュー
COROLLA						
1500 EE107, EE108G	91. 9 ~ 94. 1	HN-077C				FN-2311
AE110	95. 5 ~ 00. 8	HN-077C				FN-2311
NZE121, 121G	00. 8 ~ 06.10	HN-472				FN-2342
NZE124, 124G 4WD	00. 8 ~ 06.10	HN-472				FN-2342
NZE141 X Gt TRD TURBO	06.10 ~ 12. 5	HN-524				FN-2389
NZE141 X	06.10 ~ 12. 5	HN-508				FN-2383
G	06.10 ~ 08.10	HN-524				FN-2389
G	08.10 ~ 12. 4	HN-508				FN-2389
NZE141G	06.10 ~ 12. 4	HN-524				FN-2389
NZE144, 144G 4WD	06.10 ~ 12. 4	HN-524				FN-2389
1600 AE92	87. 5 ~ 92. 5	HN-077C		HN-136		
AE95	87.10 ~ 91. 6	HN-077C				FN-2313
AE101	91. 6 ~ 95. 5	HN-077C		HN-136		FN-2311
FX SS SUSP.	92. 5 ~ 95. 5	HN-267		HN-136		
AE101G	96. 5 ~ 00. 8	HN-077C		HN-136		
AE104	91. 9 ~ 95. 5	HN-077C				FN-2285
AE104G	95. 5 ~ 00. 8	HN-077C				FN-2285
AE111	95. 5 ~ 00. 8	HN-077C		HN-136		FN-2311
BZR, SS SUSP.	95. 5 ~ 00. 8	HN-267		HN-136		
AE114	95. 5 ~ 00. 8	HN-077C				FN-2285
AE109V	96. 5 ~ 02. 6	HN-077C				FN-2313
1800 CE90	87. 5 ~ 91. 6	HN-077C				FN-2311
CE96V	87. 8 ~ 91. 9	HN-077C				FN-2311
CE97G	87. 8 ~ 91. 9	HN-077C				FN-2311
ZZE122	00. 8 ~ 06.10	HN-472				FN-2342
LUXEL VSC	00. 8 ~ 06.10	HN-472		HN-454		
ZZE122G	00. 8 ~ 06.10	HN-472				FN-2342
ZZE123, 123G	00. 8 ~ 06.10	HN-430		HN-454		
ZZE124, 124G 4WD	00. 8 ~ 06.10	HN-472				FN-2342
ZRE142, 142G	06.10 ~ 12. 5	HN-524				FN-2389
ZRE144, 144G 4WD	06.10 ~ 12. 5	HN-524				FN-2389
2000 CE95	89.10 ~ 91. 6	HN-077C				FN-2313
CE100	91. 6 ~ 95. 5	HN-077C				FN-2311
CE100G	95. 5 ~ 98. 4	HN-077C				FN-2311
CE104	91. 9 ~ 95. 5	HN-077C				FN-2285
CE106V, 108G	91. 9 ~ 98. 4	HN-077C				FN-2311
CE109V	91. 9 ~ 98. 4	HN-077C				FN-2313
CE110	95. 5 ~ 98. 4	HN-077C				FN-2311
CE114	95. 5 ~ 98. 4	HN-077C				FN-2285
2200 CE113	98. 4 ~ 00. 8	HN-077C				FN-2311
CE116	98. 4 ~ 00. 8	HN-077C				FN-2285
CE101G	98. 4 ~ 00. 8	HN-077C				FN-2311
CE102G	98. 4 ~ 02. 6	HN-077C				FN-2311
CE105V	98. 4 ~ 02. 6	HN-077C				FN-2313
CE107V	98. 4 ~ 02. 6	HN-077C				FN-2311

- NISSAN
- TOYOTA (HINO)
- MAZDA
- ISUZU
- HONDA
- MITSUBISHI
- SUBARU
- SUZUKI
- DAIHATSU
- LEXUS
- INFINITY
- HYUNDAI
- KIA

TOYOTA - 10

- NISSAN
- TOYOTA**
(HINO)
- MAZDA
- ISUZU
- HONDA
- MITSUBISHI
- SUBARU
- SUZUKI
- DAIHATSU
- LEXUS
- INFINITI
- HYUNDAI
- KIA

Model 車種形式		Year 年式	Front フロント		Rear リア		Parking パーキング
			Pad パッド	Shoe シュー	Pad パッド	Shoe シュー	Shoe シュー
COROLLA							
2200	CE121, 121G	00. 8 ~ 04. 4	HN-472			FN-2342	
SPACIO							
1500	NZE121N FIVE-SEATER	01. 5 ~ 03. 4	HN-472			FN-2342	
	SEVEN-SEATER	01. 5 ~ 07. 6	HN-472			FN-2358	
1600	AE111N	97. 1 ~ 01. 5	HN-077C			FN-2311	
1800	AE115N	97. 1 ~ 01. 5	HN-077C			FN-2285	
	ZZE122N	01. 5 ~ 07. 6	HN-472			FN-2358	
	ZZE124N 4WD	01. 5 ~ 07. 6	HN-472			FN-2358	
RUMION							
1500	NZE151N	07.10 ~	HN-524		HN-519		
1800	ZRE152N, 154N	07.10 ~	HN-524		HN-519		
COROLLA LEVIN・CERES							
1500	AE91	87. 5 ~ 91. 6	HN-077C		HN-136	FN-2311	
	AE100	91. 6 ~ 98. 8	HN-077C			FN-2311	
	AE110	95. 5 ~ 00. 8	HN-077C			FN-2311	
1600	AE92	87. 5 ~ 91. 6	HN-077C		HN-136	FN-2311	
	AE101 SJ, X	91. 6 ~ 98. 8	HN-077C			FN-2311	
	GT	91. 6 ~ 98. 8	HN-077C		HN-136		
	GTZ, GTAPEX (SS SUSP.)	91. 6 ~ 98. 8	HN-267		HN-136		
	AE111 XZ	95. 5 ~ 00. 8	HN-077C			FN-2311	
	BZ-G	95. 5 ~ 00. 8	HN-077C		HN-136		
	BZ-V, BZ-G (SS SUSP.)	95. 5 ~ 00. 8	HN-267		HN-136		
	BZ-R	97. 4 ~ 00. 8	HN-267		HN-136		
COROLLA II・TERSEL・CORSA							
1300	EL41	90. 9 ~ 94. 9	HN-077C			FN-2321	
	EL51	94. 9 ~ 99. 7	HN-077C			FN-2321	
1500	EL43	90. 9 ~ 94. 9	HN-077C			FN-2321	
	EL45	90. 9 ~ 94. 9	HN-077C			FN-2313	
	EL53	94. 9 ~ 99. 7	HN-077C			FN-2321	
	EL55	94. 9 ~ 99. 7	HN-077C			FN-2313	
	NL40	90. 9 ~ 94. 9	HN-077C			FN-2321	
	NL50	94. 9 ~ 99. 7	HN-077C			FN-2321	
CAVALIER							
2400	TJG00-C694G SEDAN	95.10 ~ 00. 8				FN-2345	
	TJG00-C694H SEDAN	95.10 ~ 00. 8				FN-2345	
	TJG00-C374G COUPE	95.10 ~ 00. 8				FN-2345	
	TJG00-C374H COUPE	95.10 ~ 00. 8				FN-2345	

TOYOTA - 11

Model 車種形式		Year 年式	Front フロント		Rear リア		Parking パーキング
			Pad パッド	Shoe シュー	Pad パッド	Shoe シュー	Shoe シュー
CAMI							
1300	J100E	99. 5 ~ 00. 5	HN-416			FN-2333	
	J102E	00. 5 ~ 05.12	HN-416			FN-2339	
	J122E	00. 5 ~ 05.12	HN-416			FN-2339	
QUICK DELIVERY							
2400	LH80VH	SINGLE TIRE	85. 8 ~ 95. 5	HN-166		FN-2276	
	LH85VH	DOUBLE TIRE	87.11 ~ 95. 5	HN-144		FN-2276	
2700	RZU68VH	LPG	96.10 ~ 99. 8	HN-229		FN-2297	FN-2298
	BU280K	LPG	00. 1 ~ 03. 6	HN-441		FN-2296	
	RZU280K	LPG	03. 6 ~ 06.10	HN-441		FN-2296	FN-0015
	XZU281K	LPG	04. 6 ~ 06.10	HN-441		FN-2296	FN-0015
2800	LH81VH		95. 5 ~ 99. 5	HN-166		FN-2276	
	LY151		95. 5 ~ 99. 5	HN-144		FN-2276	
3000	LH82K		99. 5 ~ 01. 8	HN-166		FN-2276	
	LY152		99. 5 ~ 01. 8	HN-144		FN-2276	
	LY228K, 270		01. 8 ~ 04. 7	HN-144		FN-2296	
3400	BU68VH		95. 5 ~ 99. 8	HN-229		FN-2297	FN-2298
3700	BU280K, 281K		99. 8 ~ 04. 6	HN-441		FN-2296	
4100	XZU280K, 281K		04. 6 ~ 06.10	HN-441		FN-2296	FN-0015
	XKU280K		06.10 ~ 10.12	HN-441		FN-2296	FN-0015
CROWN							
2000	GS130		87. 9 ~ 95.12	HN-157	FN-2251	HN-142C	FN-2252
	GS130G		87. 9 ~ 99. 4	HN-157			FN-2252
	GS130H	LPG	91.12 ~ 95.12	HN-157			FN-2252
	GS131		87. 9 ~ 91.10	HN-157		HN-142C	
	GS131H		89. 8 ~ 95.12	HN-157		HN-142C	
	GS136V		87. 9 ~ 99. 4	HN-157			FN-2252
	GS141		93. 8 ~ 95. 8	HN-157		HN-142C	
	YS130		87. 9 ~ 95.12	HN-157	FN-2251		FN-2252
	GS151	SEDAN	95. 8 ~ 98. 8	HN-322		HN-323	
		HARD-TOP	95. 8 ~ 98. 8	HN-228		HN-363	
			98. 8 ~ 01. 8	HN-434		HN-409	
		LPG	95.12 ~ 01. 2	HN-322T		HN-323	
	GS151H		95. 8 ~ 01. 8	HN-228		HN-363	
		LPG	95.12 ~ 01. 2	HN-322T		HN-323	
	GS171, 171W		99. 9 ~ 03.12	HN-442		HN-421	
	GXS12, GBS12		01. 8 ~ 07. 8	HN-386T			FN-2363
	YXS10, 10H	LPG	01. 8 ~ 08. 8	HN-402T			FN-2363
	GXS10	LPG	01.10 ~ 02.10	HN-402T			FN-2363
2400	LS130		87. 9 ~ 99. 4	HN-157	FN-2251		FN-2252
		SAL	87. 9 ~ 95.12	HN-157		HN-142C	

- NISSAN
- TOYOTA (HINO)
- MAZDA
- ISUZU
- HONDA
- MITSUBISHI
- SUBARU
- SUZUKI
- DAIHATSU
- LEXUS
- INFINITY
- HYUNDAI
- KIA

TOYOTA - 12

- NISSAN
- TOYOTA**
(HINO)
- MAZDA
- ISUZU
- HONDA
- MITSUBISHI
- SUBARU
- SUZUKI
- DAIHATSU
- LEXUS
- INFINITI
- HYUNDAI
- KIA

Model 車種形式	Year 年式	Front フロント		Rear リア		Parking パーキング
		Pad パッド	Shoe シュー	Pad パッド	Shoe シュー	Shoe シュー
CROWN						
2400 LS130G	87. 9 ~ 91.10	HN-157			FN-2252	
LS130W	91.10 ~ 99. 4	HN-157			FN-2252	
LS131	89. 8 ~ 95. 9	HN-157		HN-142C		
LS136V	87. 9 ~ 94. 9	HN-157			FN-2252	
LS141	91.10 ~ 95. 8	HN-157		HN-142C		
LS151	95. 8 ~ 99. 9	HN-322		HN-323		
LS151H	95. 8 ~ 99. 9	HN-228		HN-363		
2500 JZS130G	90. 8 ~ 99. 4	HN-157			FN-2252	
JZS131, 141	90. 8 ~ 95.12	HN-157		HN-142C		
JZS151, 153	95. 8 ~ 01. 8	HN-228		HN-363		
JZS171, 171W	99. 9 ~ 03.12	HN-442		HN-421		
TURBO	99. 9 ~ 03.12	HN-324		HN-421		
JZS173, 173W 4WD	99. 9 ~ 03.12	HN-228		HN-421		
GRS180, 181 ROYAL	03.12 ~ 08. 2	HN-550		HN-494		
ATHLETE	03.12 ~ 08. 2	HN-479		HN-494		
GRS200, 201 ROYAL	08. 2 ~ 12.12	HN-550		HN-494		
ATHLETE	08. 2 ~ 12.12	HN-479		HN-494		
3000 MS135, 137	87. 9 ~ 91.10	HN-157		HN-142C		
JZS133, 135	91.10 ~ 95.12	HN-157		HN-142C		
JZS143, 145	91.10 ~ 95. 8	HN-157		HN-142C		
JZS147, 149	91.10 ~ 95. 8	HN-228		HN-363		FN-2392
JZS155	95. 8 ~ 01. 8	HN-228		HN-363		
JZS175, 175W	99. 9 ~ 03.12	HN-442		HN-421		
JZS177	99. 9 ~ 04. 6	HN-228		HN-421		
JZS179 4WD	99. 9 ~ 03.12	HN-228		HN-421		
JKS175 HIBRID	01. 8 ~ 03.12	HN-442		HN-421		
GRS182 ROYAL	03.12 ~ 08. 2	HN-550		HN-494		
ATHLETE	03.12 ~ 08. 2	HN-479		HN-494		
GRS183	03.12 ~ 12.12	HN-550		HN-494		
GRS202, 203	08. 2 ~ 12.12	HN-550		HN-494		
3500 GRS184 ATHLETE	05. 9 ~ 08. 2	HN-547		HN-494		
GRS204 ATHLETE	08. 2 ~ 12.12	HN-547		HN-494		
GWS204 HYBRID	08. 2 ~ 12.12	HN-547		HN-494		
4000 UZS131	89. 8 ~ 91.10	HN-157		HN-142C		
UZS141, 147	91.10 ~ 95. 8	HN-228		HN-363		
UZS143, 145	92.10 ~ 95. 8	HN-324		HN-363		
UZS151, 157	95. 8 ~ 99. 9	HN-228		HN-363		
UZS155	95.11 ~ 99. 9	HN-324		HN-363		
UZS171	99. 9 ~ 04. 6	HN-228		HN-421		
UZS173 4WD	99. 9 ~ 04. 6	HN-324		HN-421		
UZS175	99. 9 ~ 04. 6	HN-228		HN-421		
2500 AWS215 MAJESTA	14. 7 ~	HN-550				
3500 GWS214 MAJESTA	13. 9 ~	HN-547				

TOYOTA - 13

Model 車種形式	Year 年式	Front フロント		Rear リア		Parking パーキング
		Pad パッド	Shoe シュー	Pad パッド	Shoe シュー	Shoe シュー
CROWN						
4300 UZS186, 187 MAJESTA	04. 6 ~ 09. 4	HN-479		HN-494		
UZS207 MAJESTA	09. 3 ~ 13. 9	HN-479		HN-494		
4600 URS206 MAJESTA	09. 3 ~ 13. 9	HN-547		HN-494		
GRANVIA・GRAND HIACE						
2700 RCH11W	95. 8 ~ 98. 4	HN-237		HN-363	FN-2330	
3000 KCH10W, 16W	95. 8 ~ 02. 5	HN-237		HN-363	FN-2330	
3400 VCH10W, 16W	97. 5 ~ 02. 5	HN-237		HN-363		
VCH22K, 28K	99. 7 ~ 02. 5	HN-237			FN-2330	
KLUGER						
2400 ACU20W, 25W	00.11 ~ 03. 8	HN-457		HN-458		
	03. 8 ~ 07. 5	HN-457		HN-498		
3000 MCU20W, 25W	00.11 ~ 03. 8	HN-457		HN-458		
	03. 8 ~ 07. 5	HN-457		HN-498		
3300 MHU28W HYBRID	05. 3 ~ 07. 5	HN-497		HN-498		
COASTER						
2400 RB20	84. 8 ~ 93. 1	HN-099	FN-2294		FN-2295	
3400 BB21	84. 8 ~ 93. 1	HN-099	FN-2294		FN-2295	
BB26V	84. 8 ~ 93. 1	HN-099	FN-2294		FN-2295	
BB31	84. 8 ~ 93. 1	HN-099	FN-2294		FN-2295	
BB40, 46V	93. 1 ~ 99. 7	HN-329			FN-2329	
3700 BB23	88. 8 ~ 93. 1	HN-099	FN-2294		FN-2295	
BB24	88. 8 ~ 93. 1	HN-099			FN-2295	
4100 BB55	95.12 ~ 97. 5	HN-393		HN-394		
BB58	97. 5 ~ 04. 8	HN-393			FN-2329	
BZB40, 50	02. 3 ~	HN-330			FN-2329	
XZB40, 46V STANDARD	W/O ABS 04. 8 ~	HN-329			FN-2329	
LX	W/ ABS 04. 8 ~	HN-330			FN-2329	
XZB50, 51	04. 8 ~	HN-330			FN-2329	
XZB56V	04. 8 ~	HN-330			FN-2329	
4200 HDB20	90. 1 ~ 93. 1	HN-099			FN-2295	
HDB30, 31	90. 1 ~ 93. 1	HN-099			FN-2295	
HDB50, 51	93. 1 ~ 99. 7	HN-330			FN-2329	
	99. 7 ~ 04. 8	HN-330			FN-2329	
HZB30, 31	90. 1 ~ 93. 1	HN-099			FN-2295	
HZB36V	90. 1 ~ 93. 1	HN-099	FN-2294		FN-2295	
HZB40	W/O ABS 93. 1 ~ 99. 7	HN-329			FN-2329	
	W/O ABS 99. 7 ~ 04. 8	HN-329			FN-2329	

- NISSAN
- TOYOTA (HINO)
- MAZDA
- ISUZU
- HONDA
- MITSUBISHI
- SUBARU
- SUZUKI
- DAIHATSU
- LEXUS
- INFINITY
- HYUNDAI
- KIA

TOYOTA - 14

- NISSAN
- TOYOTA**
(HINO)
- MAZDA
- ISUZU
- HONDA
- MITSUBISHI
- SUBARU
- SUZUKI
- DAIHATSU
- LEXUS
- INFINITI
- HYUNDAI
- KIA

Model 車種形式	Year 年式	Front フロント		Rear リア		Parking パーキング
		Pad パッド	Shoe シュー	Pad パッド	Shoe シュー	Shoe シュー
COASTER						
4200 HZB40	W/ ABS	93. 1 ~ 99. 7	HN-330			FN-2329
	W/ ABS	99. 7 ~ 04. 8	HN-330			FN-2329
HZB41		93. 1 ~ 99. 7	HN-330			FN-2329
		99. 7 ~ 04. 8	HN-330			FN-2329
HZB50, 56V		93. 1 ~ 99. 7	HN-330			FN-2329
		99. 7 ~ 04. 8	HN-330			FN-2329
HZB46V	W/O ABS	99. 7 ~ 04. 8	HN-329			FN-2329
	W/ ABS	99. 7 ~ 04. 8	HN-330			FN-2329
CORONA						
1500 AT170		87.12 ~ 92. 2	HN-077C			FN-2285
ET176V		87.12 ~ 92.11	HN-077C			FN-2285
1600 AT175		88. 8 ~ 92. 2	HN-281		HN-321	
AT190		92. 2 ~ 96. 1	HN-322			FN-2285
1800 YT140		82. 9 ~ 98. 4	HN-192	FN-2267		FN-2268
ST170		87.12 ~ 92. 2	HN-077C			FN-2285
ST190		92. 2 ~ 96. 1	HN-322			FN-2285
2000 CT141		86.12 ~ 91.11	HN-192	FN-2267		FN-2268
CT170, 176V		87.12 ~ 92.11	HN-077C			FN-2285
CT190		92. 2 ~ 96. 1	HN-322			FN-2285
CT195		92. 8 ~ 96. 1	HN-322		HN-321	
ST171		87.12 ~ 92. 2	HN-281		HN-321	FN-2285
ST191, 195		92. 2 ~ 96. 1	HN-322		HN-321	
CORONA EXIV						
1800 ST180, 181		89. 9 ~ 91. 8	HN-077C			FN-2285
		91. 8 ~ 93. 9	HN-281			FN-2285
ST200, 201		93. 9 ~ 98. 4	HN-322			FN-2285
2000 ST182, 183		89. 9 ~ 93. 9	HN-281		HN-321	
ST202	TRR, TRX	93. 9 ~ 98. 4	HN-322		HN-321	
	TRG	W/O ABS	93. 9 ~ 98. 4	HN-228	HN-321	
	TRG (SS SUSP.)	W/ ABS	93. 9 ~ 98. 4	HN-362	HN-321	
ST203		93. 9 ~ 97.12	HN-322		HN-321	
ST205		94. 5 ~ 98. 4	HN-362		HN-321	
CORONA PREMIO						
1600 AT210		96. 1 ~ 01.12	HN-322			FN-2311
1800 AT211		96. 1 ~ 01.12	HN-322			FN-2311
2000 ST210		96. 1 ~ 01.12	HN-322			FN-2311
ST215		96. 1 ~ 01.12	HN-322			FN-2338
CT210		96. 1 ~ 97.12	HN-322			FN-2311
CT215		96. 1 ~ 97.12	HN-322			FN-2338
AZT240		01.12 ~ 07. 5	HN-430			

TOYOTA - 15

Model 車種形式	Year 年式	Front フロント		Rear リア		Parking パーキング
		Pad パッド	Shoe シュー	Pad パッド	Shoe シュー	Shoe シュー
CORONA PREMIO						
2200 CT211	97.12 ~ 01.12	HN-322			FN-2311	
CT216	97.12 ~ 01.12	HN-322			FN-2338	
COMFORT						
1800 SXS11Y	FOR DRIVING TRAINING SCHOOL 96.4 ~ 97.1	HN-386T			FN-2232	
	FOR DRIVING TRAINING SCHOOL 97.1 ~ 01.8	HN-402T			FN-2232	
2000 GXS10	95.12 ~ 97.1	HN-386T			FN-2333	
	97.1 ~	HN-402T			FN-2252	
GXS12, GBS12	01.8 ~	HN-386T			FN-2363	
YXS10	95.12 ~ 97.1	HN-386T			FN-2333	
	97.1 ~ 01.7	HN-402T			FN-2252	
	01.8 ~ 08.8	HN-402T			FN-2363	
YXS11	95.12 ~ 97.1	HN-386T			FN-2333	
	97.1 ~ 01.7	HN-402T			FN-2252	
	01.8 ~ 08.8	HN-402T			FN-2363	
YXS11Y	FOR DRIVING TRAINING SCHOOL 96.4 ~ 97.1	HN-402T			FN-2232	
SXS13Y	FOR DRIVING TRAINING SCHOOL 01.8 ~ 07.07	HN-402T			FN-2232	
TSS10	08.8 ~	HN-402T			FN-2363	
TSS11	08.8 ~	HN-402T			FN-2363	
TSS11Y	08.8 ~	HN-402T			FN-2363	
TSS13Y	FOR DRIVING TRAINING SCHOOL 07.9 ~ 08.8	HN-402T			FN-2232	
	FOR DRIVING TRAINING SCHOOL 08.8 ~	HN-402T			FN-2363	
2400 LXS11	95.12 ~ 97.1	HN-386T			FN-2333	
	97.1 ~ 99.8	HN-402T			FN-2252	
LXS11Y	FOR DRIVING TRAINING SCHOOL 96.4 ~ 97.1	HN-386T			FN-2232	
	FOR DRIVING TRAINING SCHOOL 97.1 ~ 99.8	HN-402T			FN-2232	
SAI						
2400 AZK10	09.12 ~ 10.1	HN-524		HN-522		
	10.1 ~	HN-524				
CYNOS						
1300 EL52	95.8 ~ 99.7	HN-077C			FN-2321	
1500 EL44	91.1 ~ 95.8	HN-077C		HN-178	FN-2321	
EL54	95.8 ~ 99.7	HN-077C			FN-2321	
SIENTA						
1500 NCP81G, 85G	03.9 ~ 04.10	HN-472			FN-2358	
	04.10 ~ 15.6	HN-540			FN-2358	
NCP175G, NHP170G, NSP170G, NSP172G	15.6 ~	HN-524				
SUPRA						
2000 GA70	86.2 ~ 93.5	HN-141		HN-142C		
2500 JZA70	90.8 ~ 93.5	HN-141		HN-142C		

- NISSAN
- TOYOTA (HINO)
- MAZDA
- ISUZU
- HONDA
- MITSUBISHI
- SUBARU
- SUZUKI
- DAIHATSU
- LEXUS
- INFINITY
- HYUNDAI
- KIA

TOYOTA - 16

- NISSAN
- TOYOTA**
(HINO)
- MAZDA
- ISUZU
- HONDA
- MITSUBISHI
- SUBARU
- SUZUKI
- DAIHATSU
- LEXUS
- INFINITI
- HYUNDAI
- KIA

Model 車種形式	Year 年式	Front フロント		Rear リア		Parking パーキング
		Pad パッド	Shoe シュー	Pad パッド	Shoe シュー	Shoe シュー
SUPRA						
3000 JZA80	93. 5 ~ 02. 8	HN-324		HN-363		
RZ,GZ 17inch	94. 8 ~ 02. 8	HN-360		HN-361		
STARLET						
1300 EP82	W/O ABS 89.12 ~ 96. 1	HN-256			FN-2321	
	W/ ABS 89.12 ~ 96. 1	HN-077C			FN-2321	
STARLET						
1300 EP82 GT	89.12 ~ 96. 1	HN-077C		HN-178		
EP85	90. 8 ~ 96. 1	HN-077C			FN-2313	
EP91	W/O ABS 96. 1 ~ 99. 7	HN-256			FN-2321	
	W/ ABS 96. 1 ~ 99. 7	HN-077C			FN-2321	
GLANZA V	96. 1 ~ 99. 7	HN-077C		HN-178		
1300 EP95	96. 1 ~ 99. 7	HN-077C			FN-2313	
1500 NP80	W/O ABS 89.12 ~ 95. 9	HN-256			FN-2321	
	W/ ABS 92. 1 ~ 95. 9	HN-077C			FN-2321	
NP90	W/O ABS 96. 1 ~ 99. 7	HN-256			FN-2321	
	W/ ABS 96. 1 ~ 99. 7	HN-077C			FN-2321	
SPARKY						
1300 S221E	00. 9 ~ 03. 3	HN-341			FN-0041	
S231E 4WD	00. 9 ~ 03. 3	HN-341			FN-0041	
SPRINTER						
1300 EE90	87. 5 ~ 91. 6	HN-077C			FN-2311	
EE96V	88. 8 ~ 91. 8	HN-077C			FN-2311	
EE101	91. 6 ~ 95. 5	HN-077C			FN-2311	
EE102V	94. 1 ~ 02. 6	HN-077C			FN-2311	
EE106V	91. 9 ~ 94. 1	HN-077C			FN-2311	
EE111	95. 5 ~ 00. 8	HN-077C			FN-2311	
1500 AE91	87. 5 ~ 91. 6	HN-077C		HN-136	FN-2311	
AE100	91. 6 ~ 98. 8	HN-077C			FN-2311	
EE98V	88. 8 ~ 91. 8	HN-077C			FN-2311	
EE103V	94. 1 ~ 02. 6	HN-077C			FN-2311	
EE104G	94. 1 ~ 02. 6	HN-077C			FN-2311	
EE107V, 108G	91. 9 ~ 94. 1	HN-077C			FN-2311	
AE110	95. 5 ~ 00. 8	HN-077C			FN-2311	
1600 AE92	87. 5 ~ 91. 6	HN-077C		HN-136		
AE95	87.10 ~ 91. 6	HN-077C			FN-2313	
AE101	91. 6 ~ 98. 8	HN-077C		HN-136	FN-2311	
AE104	91. 9 ~ 95. 5	HN-077C			FN-2285	
AE111	95. 5 ~ 00. 8	HN-077C			FN-2311	
AE114	95. 5 ~ 00. 8	HN-077C			FN-2285	
1800 CE90	87. 5 ~ 91. 6	HN-077C			FN-2311	
CE96V	88. 8 ~ 91. 8	HN-077C			FN-2311	

TOYOTA - 17

Model 車種形式	Year 年式	Front フロント		Rear リア		Parking パーキング
		Pad パッド	Shoe シュー	Pad パッド	Shoe シュー	Shoe シュー
SPRINTER						
2000 CE95	89.10 ~ 91.6	HN-077C				FN-2313
CE100	91.6 ~ 95.5	HN-077C				FN-2311
CE104	91.9 ~ 95.5	HN-077C				FN-2285
CE106V, 108G	91.9 ~ 98.4	HN-077C				FN-2311
CE109V	91.9 ~ 98.4	HN-077C				FN-2313
CE110	95.5 ~ 98.4	HN-077C				FN-2311
CE114	95.5 ~ 98.4	HN-077C				FN-2285
2200 CE102G	98.4 ~ 02.6	HN-077C				FN-2311
CE113	98.4 ~ 00.8	HN-077C				FN-2311
CE116	98.4 ~ 00.8	HN-077C				FN-2285
CE105V	98.4 ~ 02.6	HN-077C				FN-2313
CE107V	98.4 ~ 02.6	HN-077C				FN-2311
SPRINTER CARIB						
1500 AE95G	88.2 ~ 95.8	HN-077C				FN-2313
1600 AE111G	4AGE 4AFE	96.5 ~ 02.7 96.5 ~ 02.7	HN-077C HN-077C		HN-136	FN-2311
AE114G	95.8 ~ 02.7 95.8 ~ 02.7	HN-077C HN-077C				FN-2285 FN-2285
1800 AE115G	95.8 ~ 02.7	HN-077C				FN-2285
SPRINTER TRUENO・MARINO						
1500 AE91	87.5 ~ 91.6	HN-077C		HN-136		FN-2311
AE100	91.6 ~ 98.8	HN-077C				FN-2311
AE110	95.5 ~ 00.8	HN-077C				FN-2311
1600 AE92	87.5 ~ 91.6	HN-077C		HN-136		FN-2311
AE101	GT GTZ, GTAPEX (SS SUSP.)	91.6 ~ 95.5 91.6 ~ 95.5	HN-077C HN-267	HN-136 HN-136		
AE111	XZ BZ-G BZ-V, BZ-G (SS SUSP.) BZ-R	95.5 ~ 00.8 95.5 ~ 00.8 95.5 ~ 00.8 97.5 ~ 00.8	HN-077C HN-077C HN-267 HN-267			FN-2311
SCEPTER						
2200 SXV10, 15W	92.11 ~ 96.8	HN-322		HN-321		
3000 VCV10, 15W	92.11 ~ 96.8	HN-228		HN-321		
SERA						
1500 EXY10	90.3 ~ 95.12	HN-077C		HN-178		FN-2321
CELICA						
1800 ZZT230	SS1	99.8 ~ 06.4	HN-472			FN-2342
ZZT231	SS2	99.8 ~ 06.4	HN-430		HN-454	

- NISSAN
- TOYOTA (HINO)
- MAZDA
- ISUZU
- HONDA
- MITSUBISHI
- SUBARU
- SUZUKI
- DAIHATSU
- LEXUS
- INFINITY
- HYUNDAI
- KIA

TOYOTA - 18

- NISSAN
- TOYOTA**
(HINO)
- MAZDA
- ISUZU
- HONDA
- MITSUBISHI
- SUBARU
- SUZUKI
- DAIHATSU
- LEXUS
- INFINITI
- HYUNDAI
- KIA

Model 車種形式	Year 年式	Front フロント		Rear リア		Parking パーキング
		Pad パッド	Shoe シュー	Pad パッド	Shoe シュー	Shoe シュー
CELICA						
2000 ST182, 183	89. 9 ~ 93. 9	HN-281		HN-321		
ST185	89.10 ~ 91. 8			HN-321		
	91. 8 ~ 93. 9	HN-281		HN-321		
ST202 SS1	93. 9 ~ 99. 8	HN-322		HN-321		
	93. 9 ~ 97.12	HN-228		HN-321		
	97.12 ~ 99. 8	HN-267		HN-321		
ST202 SS2(SS SUSP.)	93. 9 ~ 95. 8	HN-362		HN-321		
	95. 8 ~ 99. 8	HN-362		HN-321		
ST202C CONVERTIBLE	94. 8 ~ 97.12	HN-228		HN-321		
	97.12 ~ 99. 5	HN-267		HN-321		
ST203	93. 9 ~ 97.12	HN-322		HN-321		
ST205 GT-FOUR	94. 2 ~ 99. 8	HN-360		HN-361		
CELSIOR						
4000 UCF10 B, SPEC	89.11 ~ 92. 8	HN-228		HN-252		
	92. 8 ~ 94.10	HN-324	W/O ABS	HN-363		
	92. 8 ~ 94.10	HN-325	W/ ABS	HN-326		
UCF11	92. 8 ~ 94.10	HN-325		HN-326		
UCF20, 21	94.10 ~ 00. 8	HN-370		HN-326		
4300 UCF30, 31	00. 8 ~ 06. 6	HN-455		HN-456		
CENTURY						
4000 VG40, 45	92.12 ~ 97. 1	HN-228		HN-142C		
5000 GZG50	97. 4 ~	HN-370		HN-326		
SOARER						
2000 GZ20	86. 1 ~ 91. 4	HN-141		HN-142C		
2500 JZZ30	91. 5 ~ 00.12	HN-231A		HN-363		
3000 MZ20, MZ21	86. 1 ~ 91. 4	HN-141		HN-142C		
JZZ31	94. 1 ~ 99. 8	HN-228		HN-363		
	96. 8 ~ 00.12	HN-231A	16inch WHEEL	HN-363		
4000 UZZ30, 31	91. 5 ~ 97. 9	HN-228		HN-363		FN-2392
UZZ32	91. 5 ~ 96. 8	HN-231A		HN-363		FN-2392
4300 UZZ40	01. 4 ~ 05. 7	HN-324		HN-421		FN-2392
DYNA						
2000 YU70V	84. 9 ~ 93. 9		FN-2296		FN-2296	FN-2298
3000 BU70V, 70VH	87. 9 ~ 95. 5		FN-2296		FN-2296	FN-2298
DYNA・TOYOACE・HINO DUTRO・HINO RANGER						
1800 YY51	SINGLE TIRE 87. 8 ~ 93. 9	HN-212			FN-2260	FN-2298
	DOUBLE TIRE 87. 8 ~ 93. 9	HN-212			FN-2276	FN-2298

TOYOTA - 19

Model 車種形式	Year 年式	Front フロント		Rear リア		Parking パーキング
		Pad パッド	Shoe シュー	Pad パッド	Shoe シュー	Shoe シュー
DYNA・TOYOACE・HINO DUTRO・HINO RANGER						
1800 YY51	DOUBLE CABIN					FN-2275 FN-2298
2000 YU60	SINGLE TIRE			FN-2296		FN-2296 FN-2298
	HIGH FLOOR DOUBLE TIRE		HN-099	FN-2294		FN-2295 FN-2298
	HIGH FLOOR DOUBLE TIRE		HN-388	FN-2294		FN-2295 FN-2298
	JUSTLOW			FN-2296		FN-2297 FN-2298
YU61D				FN-2294		FN-2295 FN-2298
YY52	SINGLE TIRE		HN-212			FN-2275 FN-2298
	JUSTLOW		HN-212			FN-2286 FN-2298
1.25t	SINGLE TIRE		HN-212			FN-2260 FN-2298
	SINGLE TIRE		HN-212			FN-2275 FN-2298
	DOUBLE TIRE		HN-212			FN-2276 FN-2298
	DOUBLE TIRE		HN-212			FN-2286 FN-2298
	DOUBLE TIRE		HN-212			FN-2275 FN-2298
YY61	HIGH FLOOR DOUBLE CABIN SINGLE TIRE		HN-212			FN-2275 FN-2298
	JUSTLOW DOUBLE CABIN SMALL RADIUS DOUBLE TIRE		HN-212			FN-2286 FN-2298
	FULL JUSTLOW BIG RADIUS DOUBLE TIRE		HN-229			FN-2297 FN-2298
YY101		96.10 ~ 01.7	HN-166			FN-2260
YY121,131	SINGLE TIRE		96.10 ~ 01.7	HN-144		FN-2275 FN-2298
	SINGLE TIRE		99.5 ~ 01.7	HN-144		FN-2362 FN-2298
	DOUBLE TIRE		96.10 ~ 01.7	HN-144		FN-2286 FN-2298
YY201	1t,1.25t SINGLE TIRE		95.5 ~ 01.7	HN-212		FN-2260 FN-2298
	1.5t SINGLE TIRE		95.5 ~ 01.7	HN-212		FN-2275 FN-2298
	SINGLE TIRE		99.5 ~ 01.7	HN-212		FN-2362 FN-2298
	DOUBLE TIRE		95.5 ~ 01.7	HN-212		FN-2286 FN-2298
YY211	AT		95.5 ~ 01.7	HN-212		FN-2276 FN-2298
	MT SINGLE TIRE		95.5 ~ 01.7	HN-212		FN-2275 FN-2298
	MT SINGLE TIRE		99.5 ~ 01.7	HN-212		FN-2362 FN-2298
	JUSTLOW MT DOUBLE TIRE		95.5 ~ 01.7	HN-212		FN-2286 FN-2298
	FULL JUSTLOW MT DOUBLE TIRE		95.5 ~ 01.7	HN-229		FN-2297 FN-2298
LY161,162	SINGLE JUSTLOW SINGLE TIRE		96.10 ~ 01.7	HN-144		FN-2305
	JUSTLOW DOUBLE CABIN SINGLE TIRE		96.10 ~ 01.7	HN-144		FN-2280
	1.25tSP SINGLE JUSTLOW SINGLE TIRE		96.10 ~ 01.7	HN-144		FN-2260
RZY220	1t LOW FLOOR		01.7 ~ 07.8	HN-144		FN-2305 FN-2298
	1.25tSP SINGLE JUSTLOW		01.7 ~ 07.8	HN-144		FN-2330 FN-2298
	1.5t FULL JUSTLOW W/O ABS		01.7 ~ 07.8	HN-144		FN-2297 FN-2298
	W/ ABS		01.7 ~ 07.8	HN-144		FN-2296 FN-2298
RZY230	1t SINGLE JUSTLOW		01.7 ~ 07.8	HN-144		FN-2305 FN-2298
	1.25t JUSTLOW		01.7 ~ 07.8	HN-144		FN-2330 FN-2298
	1.25t FULL JUSTLOW W/O ABS		01.7 ~ 07.8	HN-144		FN-2297 FN-2298
	W/ ABS		01.7 ~ 07.8	HN-144		FN-2296 FN-2298
	1.25t LOW FLOOR		01.7 ~ 07.8	HN-144		FN-2362 FN-2298
	1.25tSP SINGLE JUSTLOW		01.7 ~ 07.8	HN-144		FN-2330 FN-2298
TRY220,230	1t SINGLE JUSTLOW		03.5 ~	HN-144		FN-2305 FN-2298
	1.25t JUSTLOW		03.5 ~	HN-144		FN-2330 FN-2298
	1.25t LOW FLOOR		03.5 ~	HN-144		FN-2362 FN-2298
	1.5t JUSTLOW		03.5 ~	HN-144		FN-2297 FN-2298
	1.5t FULL JUSTLOW W/O ABS		03.5 ~	HN-144		FN-2297 FN-2298
	W/ ABS		03.5 ~	HN-144		FN-2296 FN-2298
TRY231,281	LPG		07.12 ~	HN-144		FN-2297
		W/O ABS		HN-144		FN-2297

- NISSAN
- TOYOTA (HINO)
- MAZDA
- ISUZU
- HONDA
- MITSUBISHI
- SUBARU
- SUZUKI
- DAIHATSU
- LEXUS
- INFINITY
- HYUNDAI
- KIA

TOYOTA - 20

- NISSAN
- TOYOTA**
(HINO)
- MAZDA
- ISUZU
- HONDA
- MITSUBISHI
- SUBARU
- SUZUKI
- DAIHATSU
- LEXUS
- INFINITI
- HYUNDAI
- KIA

Model 車種形式	Year 年式	Front フロント		Rear リア		Parking パーキング	
		Pad パッド	Shoe シュー	Pad パッド	Shoe シュー	Shoe シュー	
DYNA・TOYOACE・HINO DUTRO・HINO RANGER							
2000 TRY231,281	W/ ABS	07.12 ~	HN-144			FN-2296	
2400 LY50	DOUBLE CABIN	SINGLE TIRE	88. 8 ~ 95. 5	HN-212		FN-2260	FN-2298
	1.25t	SINGLE TIRE	85. 8 ~ 95. 5	HN-212		FN-2260	FN-2298
	1.5t	SINGLE TIRE	85. 8 ~ 95. 5	HN-212		FN-2275	FN-2298
	1.25t JUSTLOW		85. 8 ~ 95. 5	HN-212		FN-2276	FN-2298
LY50	1.5t JUSTLOW		85. 8 ~ 95. 5	HN-212		FN-2286	FN-2298
2500 KDY220,230	1t SINGLE JUSTLOW		04. 8 ~ 07. 9	HN-144		FN-2305	FN-2298
	1.25t,1.5t JUSTLOW		04. 8 ~ 07. 9	HN-144		FN-2362	FN-2298
	1.25t,1.5t FULL JUSTLOW	W/O ABS	04. 8 ~ 07. 9	HN-144		FN-2297	FN-2298
		W/ ABS	04. 8 ~ 07. 9	HN-144		FN-2296	FN-2298
	1.25tSP SINGLE JUSTLOW		04. 8 ~ 07. 9	HN-144		FN-2330	FN-2298
	1.5tSP SINGLE JUSTLOW		04. 8 ~ 07. 9	HN-144		FN-2362	FN-2298
KDY240V,290V	1.5t	W/O ABS	04. 8 ~ 07. 9	HN-144		FN-2297	FN-2298
		W/ ABS	04. 8 ~ 07. 9	HN-144		FN-2296	FN-2298
KDY270,280	1t SINGLE JUSTLOW		04. 8 ~ 07. 9	HN-144		FN-2305	FN-2298
	1.25t LOW FLOOR		04. 8 ~ 07. 9	HN-144		FN-2362	FN-2298
	1.25t FULL JUSTLOW	W/O ABS	04. 8 ~ 07. 9	HN-144		FN-2297	FN-2298
		W/ ABS	04. 8 ~ 07. 9	HN-144		FN-2296	FN-2298
	1.25tSP SINGLE JUSTLOW		04. 8 ~ 07. 9	HN-144		FN-2330	FN-2298
2700 RZU100	JUSTLOW		95. 5 ~ 00. 5		FN-2296	FN-2297	FN-2298
	FULL JUSTLOW		95. 5 ~ 00. 5	HN-229	FN-2297	FN-2297	FN-2298
	HIGH FLOOR		95. 5 ~ 00. 5	HN-388	FN-2329	FN-2329	FN-2298
RZU100A	DUMP TRUCK		95. 5 ~ 00. 5	HN-388	FN-2329	FN-2329	FN-2298
RZU100H	HIGH FLOOR		95. 5 ~ 00. 5	HN-388	FN-2329	FN-2329	FN-2298
	FULL JUSTLOW		95. 5 ~ 00. 5	HN-229	FN-2297	FN-2297	FN-2298
RZU140			97. 8 ~ 00. 5	HN-229		FN-2297	FN-2298
RZU300	2t		00. 5 ~ 07. 5	HN-441		FN-2296	FN-2298
	3t		00. 5 ~ 07. 5	HN-329		FN-2329	FN-0015
RZU301,340			00. 5 ~ 07. 5	HN-441		FN-2296	FN-0015
RZY231H,281H		W/O ABS	03. 5 ~ 07. 8	HN-144		FN-2297	FN-2298
		W/ ABS	03. 5 ~ 07. 8	HN-144		FN-2296	FN-2298
TRU300	2t FULL JUSTLOW	DOUBLE TIRE	07. 5 ~ 11. 6	HN-441		HN-543	FN-0015
	3t HIGH FLOOR	DOUBLE TIRE	07. 5 ~ 11. 6	HN-329		HN-543	FN-0015
TRU340	2t FULL JUSTLOW	DOUBLE TIRE	07. 5 ~ 11. 6	HN-441		HN-543	FN-0015
TRU500	2t FULL JUSTLOW	DOUBLE TIRE	07. 5 ~ 11. 6	HN-441		HN-543	FN-0015
2800 LY51		SINGLE TIRE	88. 8 ~ 95. 5	HN-212		FN-2275	FN-2298
	JUSTLOW		88. 8 ~ 95. 5	HN-212		FN-2286	FN-2298
LY61		SINGLE TIRE	88. 8 ~ 95. 5	HN-212		FN-2275	FN-2298
	JUSTLOW	SMALL RADIOUS DOUBLE TIRE	88. 8 ~ 95. 5	HN-212		FN-2286	FN-2298
	FULL JUSTLOW	BIG RADIOUS DOUBLE TIRE	88. 8 ~ 95. 5	HN-229		FN-2297	FN-2298
LY101			96. 5 ~ 99. 5	HN-166		FN-2260	
LY111			96.10 ~ 99. 5	HN-166		FN-2260	
	CAMPER		96.10 ~ 99. 5	HN-237		FN-2305	
LY121,131		SINGLE TIRE	96.10 ~ 99. 5	HN-144		FN-2275	FN-2298
		DOUBLE TIRE	96.10 ~ 99. 5	HN-144		FN-2286	FN-2298

TOYOTA - 21

Model 車種形式	Year 年式	Front フロント		Rear リア		Parking パーキング
		Pad パッド	Shoe シュー	Pad パッド	Shoe シュー	Shoe シュー
DYNA・TOYOACE・HINO DUTRO・HINO RANGER						
2800 LY151	JUSTLOW					FN-2260
	HIGH FLOOR DOUBLE CABIN	DOUBLE TIRE				FN-2305
LY161	SINGLE JUSTLOW	SINGLE TIRE				FN-2305
	LOW FLOOR DOUBLE CABIN, JUSTLOW					FN-2280
	SP SHINGLE JUSTLOW					FN-2260
LY201	1t, 1.25t	SINGLE TIRE				FN-2260 FN-2298
	1.5t	SINGLE TIRE				FN-2275 FN-2298
		DOUBLE TIRE				FN-2286 FN-2298
LY211		SINGLE TIRE				FN-2275 FN-2298
	JUSTLOW	DOUBLE TIRE				FN-2286 FN-2298
	FULL JUSTLOW	DOUBLE TIRE				FN-2297 FN-2298
3000 BU60		SINGLE TIRE		FN-2296		FN-2296 FN-2298
	HIGH FLOOR	DOUBLE TIRE		FN-2294		FN-2295 FN-2298
BU60	JUSTLOW			FN-2296		FN-2297 FN-2298
	FULL JUSTLOW			FN-2297		FN-2297 FN-2298
BU61		SINGLE TIRE		FN-2296		FN-2296 FN-2298
	JUSTLOW			FN-2296		FN-2297 FN-2298
	FULL JUSTLOW			FN-2297		FN-2297 FN-2298
BU70V, 70VH				FN-2296		FN-2296 FN-2298
BU83				FN-2297		FN-2297 FN-2298
BU84	JUSTLOW			FN-2296		FN-2297 FN-2298
	FULL JUSTLOW			FN-2297		FN-2297 FN-2298
LY102				FN-116		FN-2260
LY112				FN-116		FN-2260
	CAMPER			FN-237		FN-2305
LY122, 132		SINGLE TIRE		FN-144		FN-2362 FN-2298
		DOUBLE TIRE		FN-144		FN-2286 FN-2298
LY152	SP SHINGLE JUSTLOW			FN-144		FN-2260
				FN-144		FN-2305
LY162	SP SHINGLE JUSTLOW	SINGLE TIRE		FN-144		FN-2260
		DOUBLE TIRE		FN-144		FN-2276
	HIGH FLOOR, SHINGLE JUSTLOW	SINGLE TIRE		FN-144		FN-2305
	DOUBLE CABIN, LOW FLOOR, JUSTLOW	SINGLE TIRE		FN-144		FN-2280
	CAMPER			FN-144		FN-2305
LY202		SINGLE TIRE		FN-212		FN-2362 FN-2298
		DOUBLE TIRE		FN-212		FN-2286 FN-2298
LY212		SINGLE TIRE		FN-212		FN-2362 FN-2298
	JUSTLOW	DOUBLE TIRE		FN-212		FN-2286 FN-2298
	FULL JUSTLOW	DOUBLE TIRE		FN-229		FN-2297 FN-2298
LY220	1t LOW FLOOR			FN-144		FN-2305 FN-2298
	1.25t SP SINGLE JUSTLOW			FN-144		FN-2330 FN-2298
	1.5t JUSTLOW			FN-144		FN-2298
	FULL JUSTLOW	W/O ABS		FN-144		FN-2297 FN-2298
		W/ ABS		FN-144		FN-2296 FN-2298
LY230	1t SINGLE JUSTLOW			FN-144		FN-2305 FN-2298
	1.2t JUSTLOW			FN-144		FN-2298
	1.25t FULL JUSTLOW	W/O ABS		FN-144		FN-2297 FN-2298
		W/ ABS		FN-144		FN-2296 FN-2298

- NISSAN
- TOYOTA (HINO)**
- MAZDA
- ISUZU
- HONDA
- MITSUBISHI
- SUBARU
- SUZUKI
- DAIHATSU
- LEXUS
- INFINITY
- HYUNDAI
- KIA

TOYOTA - 22

- NISSAN
- TOYOTA**
(HINO)
- MAZDA
- ISUZU
- HONDA
- MITSUBISHI
- SUBARU
- SUZUKI
- DAIHATSU
- LEXUS
- INFINITI
- HYUNDAI
- KIA

Model 車種形式	Year 年式	Front フロント		Rear リア		Parking パーキング
		Pad パッド	Shoe シュー	Pad パッド	Shoe シュー	Shoe シュー
DYNA・TOYOACE・HINO DUTRO・HINO RANGER						
3000 LY230	1.25t LOW FLOOR					FN-2362 FN-2298
	1.25tSP SINGLE JUSTLOW					FN-2330 FN-2298
LY240V,290V	1.5t FULL JUSTLOW	W/O ABS	01.7 ~ 04.8	HN-144		FN-2297 FN-2298
		W/ ABS	01.7 ~ 04.8	HN-144		FN-2296 FN-2298
LY270	1t LOW FLOOR		01.7 ~ 04.8	HN-144		FN-2305 FN-2298
	1.2tSP SHINGLE JUSTLOW		01.7 ~ 04.8	HN-144		FN-2330 FN-2298
LY280	1t SINGLE JUSTLOW		01.7 ~ 04.8	HN-144		FN-2305 FN-2298
	1.25t FULL JUSTLOW	W/O ABS	01.7 ~ 04.8	HN-144		FN-2297 FN-2298
		W/ ABS	01.7 ~ 04.8	HN-144		FN-2296 FN-2298
	1.2t LOW FLOOR		01.7 ~ 04.8	HN-144		FN-2362 FN-2298
	1.25tSP SINGLE JUSTLOW		01.7 ~ 04.8	HN-144		FN-2330 FN-2298
KDY221	1t LOW FLOOR	SINGLE TIRE	07.9 ~	HN-144		FN-2305 FN-2298
	1.25t JUSTLOW		07.9 ~	HN-144		FN-2330 FN-2298
	1.5t FULL JUSTLOW	W/O ABS	07.9 ~	HN-144		FN-2297 FN-2298
KDY221		W/ ABS	07.9 ~	HN-144		FN-2296 FN-2298
KDY231	1t HIGH FLOOR		07.9 ~	HN-144		FN-2305 FN-2298
	1.25t FULL JUSTLOW	W/O ABS	07.9 ~	HN-144		FN-2297 FN-2298
		W/ ABS	07.9 ~	HN-144		FN-2296 FN-2298
	1.25t JUSTLOW		07.9 ~	HN-144		FN-2330 FN-2298
	1.5t JUSTLOW	SINGLE TIRE	07.9 ~	HN-144		FN-2362 FN-2298
KDY241V	1.5t	W/O ABS	07.9 ~	HN-144		FN-2297 FN-2298
		W/ ABS	07.9 ~	HN-144		FN-2296 FN-2298
KDY271			07.9 ~	HN-144		FN-2305 FN-2298
KDY281	1t HIGH FLOOR		07.9 ~	HN-144		FN-2305 FN-2298
	1.25t LOW FLOOR		07.9 ~	HN-144		FN-2362 FN-2298
	1.25t JUSTLOW		07.9 ~	HN-144		FN-2330 FN-2298
<hr/>						
3400 BU68DH			89.10 ~ 95.5		FN-2294	FN-2295 FN-2298
BU90			84.9 ~ 95.5		FN-2292	FN-2292 FN-2298
BU100	LOW FLOOR	SINGLE TIRE	95.5 ~ 99.5		FN-2296	FN-2296 FN-2298
	HIGH FLOOR	DOUBLE TIRE	95.5 ~ 99.5		FN-2329	FN-2329 FN-2298
	JUSTLOW		95.5 ~ 99.5		FN-2296	FN-2297 FN-2298
	FULL JUSTLOW		95.5 ~ 99.5	HN-229	FN-2297	FN-2297 FN-2298
BU100A	DUMP TRUCK		95.5 ~ 99.5	HN-388	FN-2329	FN-2329 FN-2298
BU105			97.8 ~ 99.5	HN-330		FN-2329 FN-2298
BU120			95.5 ~ 99.5		FN-2296	FN-2296 FN-2298
BU140	HIGH FLOOR		95.5 ~ 97.8		FN-2296	FN-2297 FN-2298
	JUSTLOW		95.5 ~ 97.8	HN-388	FN-2329	FN-2329 FN-2298
BU145	JUSTLOW		97.8 ~ 99.5	HN-329		FN-2297 FN-2298
	FULL JUSTLOW		97.8 ~ 99.5	HN-329		FN-2297 FN-2298
	HIGH FLOOR		97.8 ~ 99.5	HN-330		FN-2329 FN-2298
<hr/>						
3700 BU66		SINGLE TIRE	88.8 ~ 95.5		FN-2296	FN-2296 FN-2298
	HIGH FLOOR	DOUBLE TIRE	88.8 ~ 95.5	HN-099	FN-2294	FN-2295 FN-2298
	JUSTLOW		88.8 ~ 95.5		FN-2296	FN-2297 FN-2298
	FULL JUSTLOW		88.8 ~ 95.5	HN-229	FN-2297	FN-2297 FN-2298
BU66D	THREE TRANSFER STANDAEED FORMULA		88.8 ~ 95.5		FN-2294	FN-2295 FN-2298
	JUSTLOW		88.8 ~ 95.5		FN-2296	FN-2297 FN-2298
	FULL JUSTLOW		88.8 ~ 95.5		FN-2297	FN-2297 FN-2298

TOYOTA - 23

Model 車種形式	Year 年式	Front フロント		Rear リア		Parking パーキング
		Pad パッド	Shoe シュー	Pad パッド	Shoe シュー	Shoe シュー
DYNA・TOYOACE・HINO DUTRO・HINO RANGER						
3700 BU66DH	90. 8 ~ 95. 5		FN-2294		FN-2295	FN-2298
BU66H	88. 8 ~ 95. 5	HN-388	FN-2294		FN-2295	FN-2298
BU67	88. 8 ~ 95. 5	HN-388	FN-2294		FN-2295	FN-2298
BU67D	88. 8 ~ 95. 5		FN-2294		FN-2295	FN-2298
BU72, 72D	89.10 ~ 95. 5		FN-2296		FN-2297	FN-2298
BU72DH	89.10 ~ 95. 5		FN-2294		FN-2295	FN-2298
BU73, 74	89.10 ~ 95. 5		FN-2294		FN-2295	FN-2298
BU78	89.10 ~ 95. 5	HN-388	FN-2294		FN-2295	FN-2298
BU87	HIGH FLOOR DOUBLE TIRE	88. 8 ~ 95. 5	HN-388	FN-2294	FN-2295	FN-2298
	JUSTLOW	88. 8 ~ 95. 5		FN-2296	FN-2297	FN-2298
	FULL JUSTLOW	88. 8 ~ 95. 5	HN-229	FN-2297	FN-2297	FN-2298
	DOUBLE CABIN	88. 8 ~ 95. 5		FN-2294	FN-2295	FN-2298
	HIGH FLOOR DOUBLE CABIN DOUBLE TIRE	91. 9 ~ 95. 5	HN-388		FN-2295	
BU87V		88. 8 ~ 95. 5	HN-099	FN-2294	FN-2295	FN-2298
BU88	HIGH FLOOR DOUBLE TIRE	88. 8 ~ 95. 5	HN-388	FN-2294	FN-2295	FN-2298
	JUSTLOW	88. 8 ~ 95. 5		FN-2296	FN-2297	FN-2298
	FULL JUSTLOW	88. 8 ~ 95. 5	HN-388	FN-2294	FN-2295	FN-2298
	DOUBLE CABIN	88. 8 ~ 95. 5	HN-388	FN-2294	FN-2295	FN-2298
BU91, 96		88. 8 ~ 95. 5		FN-2292	FN-2292	FN-2298
BU94		88. 8 ~ 95. 5	HN-388	FN-2294	FN-2295	FN-2298
BU301		99. 5 ~ 04. 6	HN-329		FN-2329	FN-2298
BU306, 346	HIGH FLOOR	99. 5 ~ 04. 6	HN-329		FN-2329	FN-2298
	JUSTLOW	99. 5 ~ 04. 6	HN-329		FN-2296	FN-2298
	PICKUP TRUCK, FULL JUSTLOW	99. 5 ~ 04. 6	HN-441		FN-2296	FN-2298
4000 WU75D		84. 9 ~ 95. 5		FN-2292	FN-2292	FN-2298
WU85		89.10 ~ 95. 5	HN-388	FN-2294	FN-2295	FN-2298
WU90, 95		84. 9 ~ 95. 5		FN-2292	FN-2292	FN-2298
WU93		91. 9 ~ 95. 5	HN-099	FN-2294	FN-2295	FN-2298
4100 BU102	CARGO TRUCK, HIGH FLOOR	95. 5 ~ 99. 5		FN-2296	FN-2329	FN-2298
	CHASSIS WITH CABIN, HIGH FLOOR	95. 5 ~ 99. 5		FN-2329	FN-2329	FN-2298
	JUSTLOW	95. 5 ~ 99. 5		FN-2296	FN-2297	FN-2298
	FULL JUSTLOW	95. 5 ~ 99. 5		FN-2297	FN-2297	FN-2298
	DUMP TRUCK	95. 5 ~ 99. 5	HN-388	FN-2329	FN-2329	FN-2298
BU102H	HIGH FLOOR	95. 5 ~ 99. 5	HN-388	FN-2329	FN-2329	FN-2298
BU105	HIGH FLOOR	97. 8 ~ 99. 5	HN-330	FN-2329	FN-2329	
	FULL JUSTLOW, JUSTLOW	97. 8 ~ 99. 5	HN-329	FN-2329	FN-2329	
	YAMATO SPEC	97. 8 ~ 99. 5	HN-229		FN-2297	
BU107	JUSTLOW	97. 8 ~ 99. 5	HN-329		FN-2297	FN-2298
BU112	HIGH FLOOR	95. 5 ~ 99. 5	HN-388	FN-2329	FN-2329	FN-2298
BU120, 122		95. 5 ~ 99. 5		FN-2296	FN-2296	FN-2298
BU132	HIGH FLOOR	95. 5 ~ 99. 5	HN-388	FN-2329	FN-2329	FN-2298
	FULL JUSTLOW	95. 5 ~ 99. 5	HN-229	FN-2297	FN-2297	FN-2298
BU137		97. 8 ~ 99. 5	HN-329		FN-2297	FN-2298
BU142	HIGH FLOOR	95. 5 ~ 99. 5	HN-388	FN-2329	FN-2329	FN-2298
	JUSTLOW	95. 5 ~ 99. 5		FN-2296	FN-2297	FN-2298
	FULL JUSTLOW	95. 5 ~ 99. 5	HN-229	FN-2297	FN-2297	FN-2298
BU147	JUSTLOW	96.10 ~ 99. 5	HN-329		FN-2297	FN-2298

- NISSAN
- TOYOTA (HINO)
- MAZDA
- ISUZU
- HONDA
- MITSUBISHI
- SUBARU
- SUZUKI
- DAIHATSU
- LEXUS
- INFINITY
- HYUNDAI
- KIA

TOYOTA - 24

- NISSAN
- TOYOTA**
(HINO)
- MAZDA
- ISUZU
- HONDA
- MITSUBISHI
- SUBARU
- SUZUKI
- DAIHATSU
- LEXUS
- INFINITI
- HYUNDAI
- KIA

Model 車種形式	Year 年式	Front フロント		Rear リア		Parking パーキング
		Pad パッド	Shoe シュー	Pad パッド	Shoe シュー	Shoe シュー
DYNA・TOYOACE・HINO DUTRO・HINO RANGER						
4100 BU147 HIGH FLOOR	96.10 ~ 99. 5	HN-330			FN-2329	FN-2298
BU162 DUMP TRUCK, FULL JUSTLOW	95. 5 ~ 99. 5		FN-2296		FN-2297	FN-0015
REINFORCEMENT TYPE DUMP TRUCK	95. 5 ~ 99. 5		FN-2329		FN-2329	FN-0015
BU172, 182 HIGH FLOOR	95. 5 ~ 99. 5		FN-2329		FN-2329	FN-0015
BU202, 222 HIGH FLOOR DOUBLE TIRE	95. 5 ~ 99. 5	HN-388	FN-2329		FN-2329	FN-2298
BU212 JUSTLOW	95. 5 ~ 99. 5		FN-2296		FN-2297	FN-2298
FULL JUSTLOW, HIGH FLOOR	95. 5 ~ 99. 5	HN-388	FN-2329		FN-2329	FN-2298
BU297	97. 8 ~ 99. 5	HN-393		HN-394		FN-2298
BU400	99. 5 ~ 04. 6	HN-329			FN-2329	FN-0015
BU410, 420 2t HIGH FLOOR	99. 5 ~ 04. 6	HN-329			FN-2329	FN-0015
3t, 3.5t HIGH FLOOR	99. 5 ~ 04. 6	HN-329				
BU430 3.5t HIGH FLOOR	99. 5 ~ 04. 6					
BZU300, 340 2t	03. 6 ~			HN-543	FN-2296	
3t	03. 6 ~	HN-329		HN-543	FN-2329	FN-0015
BZU300A	03. 6 ~ 11. 6	HN-329		HN-543	FN-2329	FN-0015
BZU410 2t	03. 6 ~ 07. 5	HN-329			FN-2329	FN-0015
3t	03. 6 ~ 07. 5					
XZU301A, 301H	00. 5 ~ 04. 6	HN-329			FN-2329	
XZU304 1.75t	03.10 ~ 06.10	HN-329			FN-2329	FN-0015
2t	03.10 ~ 06.10	HN-441			FN-2296	
2t HIGH FLOOR DOUBLE TIRE	06.10 ~ 11. 6	HN-329		HN-543	FN-2296	
2t FULL JUSTLOW DOUBLE TIRE	06.10 ~ 11. 6	HN-441		HN-543	FN-2296	
XZU304A, 304H	03.10 ~ 06.10	HN-329		HN-543	FN-2329	
XZU305A	03.10 ~ 11. 6	HN-329			FN-2329	
XZU308 2t JUSTLOW DOUBLE TIRE	04. 6 ~ 06.10	HN-329		HN-543	FN-2329	FN-0015
2t FULL JUSTLOW DOUBLE TIRE	04. 6 ~ 06.10	HN-441		HN-543	FN-2296	FN-0015
XZU314 3t	04. 6 ~ 06.10	HN-329		HN-543	FN-2329	FN-4443
XZU324D	06.10 ~ 11. 6	HN-329		HN-543		FN-4443
XZU334 2t	04. 6 ~ 06.10	HN-441			FN-2296	FN-0015
3t HIGH FLOOR DOUBLE TIRE	04. 6 ~ 06.10	HN-329		HN-543	FN-2329	FN-0015
4t HIGH FLOOR DOUBLE TIRE	04. 6 ~ 11. 6	HN-464		HN-464		
XZU338 2t JUSTLOW DOUBLE TIRE	04. 6 ~ 06.10	HN-329		HN-543	FN-2296	FN-0015
2t FULL JUSTLOW DOUBLE TIRE	04. 6 ~ 06.10	HN-441		HN-543	FN-2296	FN-0015
XZU344 2t	03.10 ~ 06.10	HN-441			FN-2296	FN-0015
2t HIGH FLOOR DOUBLE TIRE	06.10 ~ 11. 6	HN-329		HN-543	FN-2296	FN-0015
2t FULL JUSTLOW DOUBLE TIRE	06.10 ~ 11. 6	HN-441			FN-2296	FN-0015
3t	03.10 ~ 06.10	HN-329			FN-2329	FN-0015
3.5t HIGH FLOOR DOUBLE TIRE	04. 6 ~ 11. 6	HN-464		HN-464		
XZU348 JUSTLOW	04. 6 ~ 06.10	HN-329		HN-543	FN-2296	FN-0015
FULL JUSTLOW	04. 6 ~ 06.10	HN-441		HN-543	FN-2296	FN-0015
XZU354 2t FULL JUSTLOW DOUBLE TIRE	04. 6 ~ 06.10	HN-441		HN-543	FN-2296	
4t HIGH FLOOR DOUBLE TIRE	04. 6 ~ 11. 6	HN-464		HN-464		
XZU368, 368D	04. 6 ~ 06.10	HN-329		HN-543	FN-2329	FN-4443
XZU378, 388	04. 6 ~ 06.10	HN-329		HN-543	FN-2329	FN-4443
XZU404 2t FULL JUSTLOW DOUBLE TIRE	06.10 ~ 11. 6	HN-329		HN-543		FN-0015
3.5t HIGH FLOOR DOUBLE TIRE	04. 6 ~ 11. 6	HN-464		HN-464		FN-4443
XZU404A 4t HIGH FLOOR DOUBLE TIRE	04. 6 ~ 11. 6	HN-464		HN-464		FN-4443
XZU414 2t HIGH FLOOR DOUBLE TIRE	03.10 ~ 06.10	HN-329		HN-543	FN-2329	FN-0015
3t, 4t HIGH FLOOR DOUBLE TIRE	03.10 ~ 11. 6	HN-464		HN-464		

TOYOTA - 25

Model 車種形式	Year 年式	Front フロント		Rear リア		Parking パーキング
		Pad パッド	Shoe シュー	Pad パッド	Shoe シュー	Shoe シュー
DYNA・TOYOACE・HINO DUTRO・HINO RANGER						
4100 XZU415	3t CABIN			HN-464		
XZU424	2t HIGH FLOOR DOUBLE TIRE			HN-329		FN-0015
	3t HIGH FLOOR DOUBLE TIRE			HN-464		FN-4443
XZU434	3.5t, 4t DOUBLE TIRE			HN-464		FN-4443
XZU454	2t FULL JUSTLOW DOUBLE TIRE			HN-329		FN-0015
XZU488	2t FULL JUSTLOW, 3t HIGH FLOOR DOUBLE TIRE			HN-329		FN-4443
XZU504	2t HIGH FLOOR SINGLE TIRE			HN-329		FN-0015
	2t FULL JUSTLOW DOUBLE TIRE				FN-2329	FN-0015
XZU508, 508V	2t FULL JUSTLOW DOUBLE TIRE			HN-553		FN-0015
XZU524D	2t HIGH FLOOR DOUBLE TIRE			HN-553		FN-4443
XZU538	2t FULL JUSTLOW DOUBLE TIRE			HN-553		FN-0015
XZU548	2t HIGH FLOOR, FULL JUSTLOW DOUBLE TIRE			HN-553		FN-0015
XZU554D	2t HIGH FLOOR, FULL JUSTLOW DOUBLE TIRE			HN-553		FN-0015
XZU568, 568D	2t FULL JUSTLOW DOUBLE TIRE			HN-329		FN-4443
XKU304	2t HYBRID			HN-329		FN-2329
XKU308	2t FULL JUSTLOW HYBRID DOUBLE TIRE			HN-441		FN-0015
	2t HIGH FLOOR HYBRID DOUBLE TIRE			HN-329		FN-0015
XKU308H	2t HIGH FLOOR HYBRID DOUBLE TIRE			HN-329		FN-0015
XKU338	2t FULL JUSTLOW HYBRID DOUBLE TIRE			HN-441		FN-0015
XKU344	2t HIGH FLOOR HYBRID DOUBLE TIRE			HN-329		FN-2329
XKU348	2t HIGH FLOOR HYBRID DOUBLE TIRE			HN-329		FN-0015
	2t FULL JUSTLOW HYBRID DOUBLE TIRE			HN-441		FN-0015
XKU414	2t FULL JUSTLOW HYBRID DOUBLE TIRE			HN-329		FN-2329
	3t HIGH FLOOR HYBRID DOUBLE TIRE			HN-464		
XKU424	HYBRID DOUBLE TIRE			HN-464		
XKU508	2t FULL JUSTLOW HYBRID DOUBLE TIRE			HN-553		FN-0015
XKU508H	2t HIGH FLOOR HYBRID DOUBLE TIRE			HN-553		FN-0015
4600 XZU302	3t HIGH FLOOR, FULL JUSTLOW			HN-329		FN-2329
	2t FULL JUSTLOW LPG			HN-441		FN-2296
	2t			HN-441		FN-2296
XZU302A	2t DUMP TRUCK			HN-329		FN-2329
XZU302D	2t DUMP TRUCK			HN-329		FN-2329
XZU302H	3t TRUCK			HN-329		FN-2329
XZU307	HIGH FLOOR			HN-329		FN-2329
	JUSTLOW			HN-329		FN-2296
	PICKUP TRUCK, FULL JUSTLOW			HN-441		FN-2296
XZU312D	2t DUMP TRUCK			HN-441		FN-2296
	3t DUMP TRUCK			HN-329		FN-2329
XZU322	2t TRUCK			HN-329		FN-2329
XZU322D	2t DUMP TRUCK			HN-329		FN-2329
XZU337	JUSTLOW			HN-329		FN-2296
	FULL JUSTLOW			HN-441		FN-2296
XZU342	HIGH FLOOR			HN-329		FN-2329
	FULL JUSTLOW			HN-441		FN-2296
	2t			HN-441		FN-2296
XZU347	HIGH FLOOR			HN-329		FN-2329
	JUSTLOW			HN-329		FN-2296
	FULL JUSTLOW			HN-441		FN-2296

- NISSAN
- TOYOTA (HINO)
- MAZDA
- ISUZU
- HONDA
- MITSUBISHI
- SUBARU
- SUZUKI
- DAIHATSU
- LEXUS
- INFINITY
- HYUNDAI
- KIA

TOYOTA - 26

- NISSAN
- TOYOTA**
(HINO)
- MAZDA
- ISUZU
- HONDA
- MITSUBISHI
- SUBARU
- SUZUKI
- DAIHATSU
- LEXUS
- INFINITI
- HYUNDAI
- KIA

Model 車種形式	Year 年式	Front フロント		Rear リア		Parking パーキング
		Pad パッド	Shoe シュー	Pad パッド	Shoe シュー	Shoe シュー
DYNA・TOYOACE・HINO DUTRO・HINO RANGER						
4600 XZU352D JUSTLOW,DUMP TRUCK	99. 5 ~ 04. 6	HN-329			FN-2296	FN-0015
DUMP TRUCK,FULL JUSTLOW	99. 5 ~ 04. 6	HN-441			FN-2296	FN-0015
XZU362	99. 7 ~ 04. 6	HN-330			FN-2329	FN-0015
XZU362A,362D 2t DUMP TRUCK	99. 7 ~ 04. 6	HN-330			FN-2329	FN-0015
XZU372,382	99. 7 ~ 04. 6	HN-330			FN-2329	FN-0015
XZU402 JUSTLOW	99. 5 ~ 04. 6	HN-329			FN-2296	FN-0015
XZU402 FULL JUSTLOW	99. 5 ~ 04. 6	HN-329			FN-2329	FN-0015
XZU412 2tHIGH FLOOR	99. 5 ~ 04. 6	HN-329			FN-2329	FN-0015
2t JUSTLOW	99. 5 ~ 04. 6	HN-329			FN-2296	FN-0015
3t HIGH FLOOR	99. 5 ~ 04. 6					
2t,3t	99. 5 ~ 03. 6	HN-329			FN-2329	
4700 XZU413 2t HIGH FLOOR	04. 6 ~ 06.10	HN-329			FN-2329	
3t,4t HIGH FLOOR	04. 6 ~ 06.10	HN-464		HN-464		FN-4443
XZU423 2t FULL JUSTLOW	04. 6 ~ 06.10	HN-329			FN-2329	
3.5t HIGH FLOOR	04. 6 ~ 06.10	HN-464		HN-464		FN-4443
XZU433 3.5t HIGH FLOOR	04. 6 ~ 06.10	HN-464		HN-464		FN-4443
4900 XZU301 2t	99. 5 ~ 04. 6	HN-329			FN-2329	
	04. 6 ~ 11. 7	HN-441			FN-2296	
XZU301A,301D 2t,3t DUMP TRUCK	99. 5 ~ 11. 7	HN-329			FN-2329	
XZU301H 2.95t,3t TRUCK	99. 5 ~ 11. 7	HN-329			FN-2329	FN-0015
XZU306 HIGH FLOOR	99. 5 ~ 11. 7	HN-329			FN-2329	FN-0015
JUSTLOW	99. 5 ~ 11. 7	HN-329			FN-2296	FN-0015
FULL JUSTLOW	99. 5 ~ 11. 7	HN-441			FN-2296	FN-0015
XZU311A 3t DUMP TRUCK	99. 5 ~ 02. 6	HN-329			FN-2329	FN-0015
XZU311D 2t DUMP TRUCK	99. 5 ~ 11. 7	HN-441			FN-2296	
3t DUMP TRUCK	99. 5 ~ 11. 7	HN-329			FN-2329	
XZU321A 3t DUMP TRUCK	99. 5 ~ 02. 6	HN-329			FN-2329	FN-0015
XZU321D 2t,3t DUMP TRUCK	99. 5 ~ 11. 7	HN-329			FN-2329	
XZU331 3t TRUCK	99. 5 ~ 11. 7	HN-329			FN-2329	FN-0015
XZU341 2.95t	99. 5 ~ 11. 7	HN-329			FN-2329	FN-0015
2t	04. 6 ~ 11. 7	HN-441			FN-2329	FN-0015
3t	00. 5 ~ 04. 6	HN-329			FN-2329	FN-0015
XZU336 JUSTLOW	04. 6 ~ 11. 7	HN-329			FN-2296	FN-0015
FULL JUSTLOW	04. 6 ~ 11. 7	HN-441			FN-2296	FN-0015
XZU346 HGH FLOOR,JUSTLOW	99. 5 ~ 11. 7	HN-329			FN-2329	FN-0015
FULL JUSTLOW	99. 5 ~ 11. 7	HN-441			FN-2296	FN-0015
XZU351D JUSTLOW,DUMP TRUCK	99. 5 ~ 11. 7	HN-329			FN-2296	
DUMP TRUCK,FULL JUSTLOW	99. 5 ~ 11. 7	HN-441			FN-2296	
XZU371 3t	99. 5 ~ 04. 6	HN-330			FN-2329	FN-0015
XZU401 2t JUSTLOW	99. 5 ~ 06.10	HN-329			FN-2296	FN-0015
2t FULL JUSTLOW	99. 5 ~ 06.10	HN-329			FN-2329	FN-0015
3t HIGH FLOOR	99. 5 ~ 06.10	HN-464		HN-464		
XZU411 2t HIGH FLOOR	99. 5 ~ 06.10	HN-329			FN-2329	FN-0015
2t JUSTLOW	99. 5 ~ 06.10	HN-329			FN-2296	FN-0015
3t HIGH FLOOR	04. 6 ~ 06.10	HN-464		HN-464		
XZU421 2t HIGH FLOOR	99. 5 ~ 06.10	HN-329			FN-2329	FN-0015
3t FULL JUSTLOW	99. 5 ~ 06.10	HN-464		HN-464		

TOYOTA - 27

Model 車種形式	Year 年式	Front フロント		Rear リア		Parking パーキング
		Pad パッド	Shoe シュー	Pad パッド	Shoe シュー	Shoe シュー
DYNA・TOYOACE・HINO DUTRO・HINO RANGER						
4900 XZU421 3t HIGH FLOOR	99.5 ~ 06.10					
5300 XZU130, 140	95.5 ~ 99.5		FN-2329		FN-2329	FN-0015
XZU300H, 320 3t	95.5 ~ 04.6	HN-329			FN-2329	FN-0015
XZU310	99.5 ~ 04.6	HN-329			FN-2296	
XZU330, 340 3t	99.5 ~ 04.6	HN-329			FN-2329	FN-0015
XZU330, 340 3.5t, 4t	99.5 ~ 04.6	HN-329				
XZU350H 4t WORK PLATFORM	99.5 ~ 04.6					
XZU400, 400A 3.5t, 4t	99.5 ~ 04.6					
XZU410 2t FULL JUSTLOW	99.5 ~ 04.6	HN-329			FN-2329	FN-0015
3t HIGH FLOOR	99.5 ~ 04.6					
XZU420 3.5t HIGH FLOOR	99.5 ~ 04.6					
XZU430 3.5t HIGH FLOOR	99.5 ~ 04.6					
TOWN ACE						
1500 KM51	86.10 ~ 99.2	HN-216			FN-2232	
	99.2 ~ 99.6	HN-216			FN-2339	
KR27V	92.1 ~ 96.10	HN-328			FN-2232	
KR41V	96.11 ~ 98.12	HN-404			FN-2339	
S402M, U, S412M, U	08.01 ~	HN-552			FN-2398	
1800 YM55	86.10 ~ 99.2	HN-216			FN-2232	
	99.2 ~ 99.6	HN-216			FN-2339	
YM60, 65	86.10 ~ 99.6	HN-217			FN-2252	
YR20G	82.11 ~ 92.1	HN-216			FN-2232	
YR25V	92.1 ~ 96.10	HN-328			FN-2232	
KR42V	96.11 ~ 07.8	HN-404			FN-2339	
KR52V	04.10 ~ 07.8	HN-405			FN-2335A	
KM70	99.6 ~ 07.8	HN-404			FN-2339	
KM75	99.6 ~ 07.8	HN-404			FN-2339	
CAMPER-BASED	02.8 ~ 07.8	HN-503			FN-2335A	
KM80, 85	99.6 ~ 07.8	HN-503			FN-2335A	
2000 CM51	86.10 ~ 99.2	HN-216			FN-2232	
	99.2 ~ 99.6	HN-216			FN-2339	
CM55	86.10 ~ 99.2	HN-216			FN-2232	
	99.2 ~ 99.6	HN-216			FN-2339	
AERIAL WORK PLATFORMS	94.4 ~ 99.6	HN-328			FN-2252	
CM52, 61	91.10 ~ 99.6	HN-217			FN-2317	
CM60	86.10 ~ 99.6	HN-217			FN-2252	
CM65	86.10 ~ 99.6	HN-217			FN-2252	
AERIAL WORK PLATFORMS	96.11 ~ 99.6	HN-327			FN-2330	
CR21G	83.4 ~ 92.1	HN-216			FN-2232	
	W/O ABS	92.1 ~ 93.9	HN-328		FN-2232	
	W/ ABS	92.1 ~ 93.9	HN-328		FN-2252	
CR27V	84.9 ~ 92.1	HN-216			FN-2232	
	92.1 ~ 96.10	HN-328			FN-2232	
CR28G	85.8 ~ 92.1	HN-216			FN-2232	
	92.1 ~ 93.9	HN-328			FN-2232	

- NISSAN
- TOYOTA (HINO)
- MAZDA
- ISUZU
- HONDA
- MITSUBISHI
- SUBARU
- SUZUKI
- DAIHATSU
- LEXUS
- INFINITY
- HYUNDAI
- KIA

TOYOTA - 28

- NISSAN
- TOYOTA**
(HINO)
- MAZDA
- ISUZU
- HONDA
- MITSUBISHI
- SUBARU
- SUZUKI
- DAIHATSU
- LEXUS
- INFINITI
- HYUNDAI
- KIA

Model 車種形式	Year 年式	Front フロント		Rear リア		Parking パーキング
		Pad パッド	Shoe シュー	Pad パッド	Shoe シュー	Shoe シュー
TOWN ACE						
2000 CR30G, 37G	85.10 ~ 92. 1	HN-218			FN-2252	
	92. 1 ~ 93. 9	HN-327			FN-2252	
CR36V	85.10 ~ 92. 1	HN-218			FN-2252	
	92. 1 ~ 96.10	HN-327			FN-2252	
YR21G	83. 5 ~ 92. 1	HN-216			FN-2232	
	W/O ABS 92. 1 ~ 96.10	HN-328			FN-2232	
	W/ ABS 92. 1 ~ 96.10	HN-328			FN-2252	
YR30G	85.10 ~ 92. 1	HN-218			FN-2252	
	92. 1 ~ 96.10	HN-327			FN-2252	
YR36G	86. 8 ~ 92. 1	HN-218			FN-2252	
CR31G, 38G	93. 9 ~ 96.10	HN-327			FN-2252	
CR41V	96.11 ~ 98.12	HN-404			FN-2339	
CR51V	96.11 ~ 98.12	HN-405			FN-2335A	
2200						
CR22G, 29G MT	W/O ABS 93. 9 ~ 96.10	HN-328			FN-2252	
CR22G, 29G AT	W/O ABS 93. 9 ~ 96.10	HN-328			FN-2232	
	AT W/ ABS 93. 9 ~ 96.10	HN-328			FN-2252	
CR31G, 38G	93. 9 ~ 96.10	HN-327			FN-2252	
CR42V	98.12 ~ 04. 7	HN-404			FN-2339	
CR52V	98.12 ~ 04. 7	HN-405			FN-2335A	
CM70, 75	99. 6 ~ 04. 8	HN-404			FN-2339	
CM75	YAMATO SPEC 99. 6 ~ 04. 8	HN-404			FN-2252	
	CAMPER BASED 02. 8 ~ 04. 8	HN-503			FN-2335A	
CM80, 85	99. 6 ~ 04. 8	HN-503			FN-2335A	
CM85	YAMATO SPEC 99. 6 ~	HN-273			FN-2330	
DUET						
1000 M100A	98. 9 ~ 99. 9	HN-427			FN-0037	
M110A	V W/O ABS 98. 9 ~ 04. 5	HN-427			FN-0020	
	X, V W/ ABS 98. 9 ~ 04. 5	HN-427			FN-0036	
1300 M101A	X, V 00. 5 ~ 04. 5	HN-427			FN-0037	
	S 01.12 ~ 04. 5	HN-443			FN-0037	
M111A	X, V 00. 5 ~ 04. 5	HN-427			FN-0036	
	S 01.12 ~ 04. 5	HN-443			FN-0036	
DELIBOY						
1500 KXC10V	89. 7 ~ 95.11	HN-216			FN-2232	
2000 CXC10V	91. 5 ~ 95.11	HN-216			FN-2232	
NADIA						
2000 SXN10, 10H	98. 7 ~ 01. 4	HN-401			FN-2339	
SXN15, 15H	98. 7 ~ 02. 8	HN-401			FN-2339	
ACN10, 10H	01. 4 ~ 03. 7	HN-401			FN-2339	
ACN15, 15H	02. 8 ~ 03. 7	HN-401			FN-2339	
NOAH・VOXY						
2000 AZR60G	01.11 ~ 07. 6	HN-470			FN-2371	

TOYOTA - 29

Model 車種形式	Year 年式	Front フロント		Rear リア		Parking パーキング
		Pad パッド	Shoe シュー	Pad パッド	Shoe シュー	Shoe シュー
NOAH・VOXY						
2000 AZR65G 4WD	01.11 ~ 07. 6	HN-470			FN-2371	
ZRR70G, W	07. 6 ~ 14. 1	HN-524		HN-449	FN-2371	
ZRR75G, W 4WD	07. 6 ~ 14. 1	HN-524		HN-449		
HIACE・REGIUSACE						
1800 YH81	SINGLE TYRE	88. 3 ~ 95. 5	HN-227		FN-2260	
	DOUBLE TYRE	88. 3 ~ 95. 5	HN-227		FN-2276	
2000 RZH100G, 110G		89. 8 ~ 93. 8	HN-227		FN-2317	
		93. 8 ~ 95. 8	HN-237		FN-2330	
RZH102V		89. 8 ~ 96. 8	HN-227		FN-2317	
		96. 8 ~ 03. 7	HN-237		FN-2330	
RZH112K (V)	LOW FLOOR	89. 8 ~ 93. 8	HN-227		FN-2317	
		93. 8 ~ 96. 8	HN-227		FN-2330	
		96. 8 ~ 03. 7	HN-237		FN-2330	
	JUSTLOW	89. 8 ~ 95. 8	HN-227			
	JUSTLOW	95. 8 ~ 96. 8	HN-227		FN-2335	
	JUSTLOW	96. 8 ~ 03. 7	HN-237		FN-2330	
RZH122V	LOW FLOOR	89. 8 ~ 93. 8	HN-227		FN-2317	
RZH124B		89. 8 ~ 93. 8	HN-227		FN-2317	
		93. 8 ~ 96. 8	HN-227		FN-2330	
		96. 8 ~ 03. 7	HN-237		FN-2330	
RZH182K, 183K		00.12 ~ 03. 8	HN-237		FN-2330	
YY101		95. 5 ~ 96.10	HN-227		FN-2260	
TRH102V, 112V		03. 8 ~ 04. 8	HN-237		FN-2330	
TRH112K, 122K		03. 8 ~ 04. 8	HN-237		FN-2330	
TRH124B		03. 8 ~ 05. 1	HN-237		FN-2330	
TRH200K, 200V		04. 8 ~	HN-516		FN-2378	
2400 LH80	SINGLE TYRE	87. 8 ~ 95. 5	HN-227		FN-2260	
	DOUBLE TYRE	87. 2 ~ 95. 5	HN-227		FN-2276	
	DOUBLE CABIN	87. 2 ~ 95. 5	HN-227		FN-2260	
LH85, 95	S JUSTLOW, DOUBLE CABIN	87.10 ~ 95. 5	HN-144		FN-2305	
	SS JUSTLOW, DOUBLE CABIN	87.10 ~ 95. 5	HN-144		FN-2260	
LH90	SINGLE TYRE	91. 9 ~ 95. 5	HN-227		FN-2260	
	DOUBLE TYRE	91. 9 ~ 95. 5	HN-227		FN-2276	
LH100G, 110G		89. 8 ~ 93. 8	HN-227		FN-2317	
LH102V	LOW FLOOR	89. 8 ~ 93. 8	HN-227		FN-2317	
	JUSTLOW	89. 8 ~ 93. 8	HN-227		FN-2282A	
LH120G, 140G		90.10 ~ 93. 8	HN-227		FN-2317	
RZH101G		89. 8 ~ 93. 8	HN-227		FN-2317	
		93. 8 ~ 02. 8	HN-237		FN-2330	
RZH133V		95. 8 ~ 99. 7	HN-237		FN-2330	
RZH111G		95. 8 ~ 02. 8	HN-237		FN-2330	
RZH125B		98. 8 ~ 03. 8	HN-237		FN-2330	
2500 KDH200K, 205K		04. 8 ~	HN-516		FN-2378	
KDH200V, 205V		04. 8 ~	HN-516		FN-2378	
KDH220K, 225K		05. 1 ~ 07. 9	HN-516		FN-2378	

- NISSAN
- TOYOTA (HINO)
- MAZDA
- ISUZU
- HONDA
- MITSUBISHI
- SUBARU
- SUZUKI
- DAIHATSU
- LEXUS
- INFINITY
- HYUNDAI
- KIA

TOYOTA - 30

- NISSAN
- TOYOTA**
(HINO)
- MAZDA
- ISUZU
- HONDA
- MITSUBISHI
- SUBARU
- SUZUKI
- DAIHATSU
- LEXUS
- INFINITI
- HYUNDAI
- KIA

Model 車種形式	Year 年式	Front フロント		Rear リア		Parking パーキング
		Pad パッド	Shoe シュー	Pad パッド	Shoe シュー	Shoe シュー
HIACE・REGIUSACE						
2500 KDH222B, 227B	05. 1 ~ 07. 9	HN-516			FN-2378	
2700 TRH214W, 219W	04. 8 ~	HN-516			FN-2378	
TRH221K, 226K	05. 1 ~	HN-516			FN-2378	
TRH224W, 229W	05. 1 ~	HN-516			FN-2378	
TRH223B, 228B	05. 1 ~	HN-516			FN-2378	
TRH211K, 216K	07. 9 ~	HN-516			FN-2378	
2800 LH103V	LOW FLOOR 93. 8 ~ 96. 8	HN-227			FN-2330	
	LOW FLOOR 96. 8 ~ 98. 8	HN-237			FN-2330	
JUSTLOW	89. 8 ~ 95. 8	HN-227				
JUSTLOW	95. 8 ~ 96. 8	HN-227			FN-2335	
JUSTLOW	96. 8 ~ 98. 8	HN-237			FN-2330	
LH107G	89. 8 ~ 93. 8	HN-237			FN-2305	
LH107W	90.10 ~ 93. 8	HN-237			FN-2305	
LH109V	89. 8 ~ 98. 8	HN-237			FN-2305	
LH113K (V)	LOW FLOOR 89. 8 ~ 93. 8	HN-227			FN-2317	
	93. 8 ~ 96. 8	HN-227			FN-2330	
	96. 8 ~ 98. 8	HN-237			FN-2330	
JUSTLOW	89. 8 ~ 95. 8	HN-227				
JUSTLOW	95. 8 ~ 96. 8	HN-227			FN-2335	
JUSTLOW	96. 8 ~ 98. 8	HN-237			FN-2330	
LH115B	89. 8 ~ 98. 8	HN-227			FN-2317	
LH117G	90.10 ~ 93. 8	HN-237			FN-2305	
LH123V	89. 8 ~ 93. 8	HN-227			FN-2317	
	93. 8 ~ 96. 8	HN-227			FN-2330	
	96. 8 ~ 98. 8	HN-237			FN-2330	
LH125B	89. 8 ~ 93. 8	HN-227			FN-2317	
	93. 8 ~ 96. 8	HN-227			FN-2330	
	96. 8 ~ 98. 8	HN-237			FN-2330	
LH129V	90.10 ~ 98. 8	HN-237			FN-2305	
LY101, 111	95. 5 ~ 96.10	HN-227			FN-2260	
LY151, 161	JUSTLOW 95. 5 ~ 96.10	HN-144			FN-2260	
	DOUBLE CABIN 95. 5 ~ 96.10	HN-144			FN-2305	
3000 KZH100G	93. 8 ~ 04. 8	HN-237			FN-2330	
KZH106G, 106W	93. 8 ~ 04. 8	HN-237			FN-2305	
KZH110G, 120G EXCL. KZH120G At MODEL	93. 8 ~ 04. 8	HN-237			FN-2330	
KZH120G AT	93. 8 ~ 04. 8	HN-237			FN-2305	
KZH116G, 126G	93. 8 ~ 04. 8	HN-237			FN-2305	
KZH132V	95. 8 ~ 04. 8	HN-237			FN-2330	
KZH138V	95. 8 ~ 04. 8	HN-237			FN-2305	
LH162V, 172V	98. 8 ~ 04. 8	HN-237			FN-2330	
LH172K, 182K	98. 8 ~ 04. 8	HN-237			FN-2330	
LH168V, 178V	98. 8 ~ 04. 8	HN-237			FN-2305	
LH184B	98. 8 ~ 04. 8	HN-237			FN-2330	
LH188K	98. 8 ~ 04. 8	HN-237			FN-2305	
KDH201K, 201V	07. 9 ~	HN-516			FN-2378	
KDH206K, 206V	07. 9 ~	HN-516			FN-2378	

TOYOTA - 31

Model 車種形式	Year 年式	Front フロント		Rear リア		Parking パーキング
		Pad パッド	Shoe シュー	Pad パッド	Shoe シュー	Shoe シュー
HIACE・REGIUSACE						
3000 KDH211K, 221K	07. 9 ~	HN-516				FN-2378
KDH223B, 228B	07. 9 ~	HN-516				FN-2378
HILUX・HILUXSURF						
1800 YN80, 85	88. 9 ~ 94. 8	HN-209				FN-2260
2000 YN81, 86	94. 8 ~ 97. 8	HN-209				FN-2330
YN86 JUSTLOW	94. 8 ~ 97. 8	HN-209				FN-2260
YN100, 105	88. 9 ~ 94. 8	HN-219				FN-2305
YN107	91. 8 ~ 97. 8	HN-219				FN-2305
YN130G	89. 4 ~ 91. 8	HN-219				FN-2305
RZN147	97. 8 ~ 99. 8	HN-227				FN-2330
	99. 8 ~ 03. 8	HN-227				FN-2252
RZN167	97. 8 ~ 99. 8	HN-219				FN-2305
RZN152H	99. 8 ~ 03. 8	HN-227				FN-2252
2400 LN80, 85	88. 9 ~ 94. 8	HN-209				FN-2260
LN130G	89. 4 ~ 91. 8	HN-219				FN-2305
	91. 8 ~ 93. 8	HN-351				FN-2305
LN130W	91. 8 ~ 93. 8	HN-351				FN-2305
LN108, 112	95. 8 ~ 97. 8	HN-219				FN-2305
LN165, 165H	97. 8 ~ 99. 8	HN-219				FN-2305
LN170H	97.11 ~ 99. 8	HN-219				FN-2305
2700 RZN180W, 185W	95.11 ~ 02.11	HN-387				FN-2305
RZN169H, 174H	99. 8 ~ 03. 8	HN-219				FN-2305
RZN210W, 215W	02.11 ~ 04. 8	HN-482		HN-243		
TRN210W, 215W	04. 8 ~ 09. 8	HN-482		HN-243		
2800 LN81, 86	94. 8 ~ 97. 8	HN-209				FN-2330
LN86 JUSTLOW	94. 8 ~ 97. 8	HN-209				FN-2260
LN100, 106	88. 9 ~ 97. 8	HN-219				FN-2305
LN107, 109	91. 8 ~ 97. 8	HN-219				FN-2305
LN131V	89. 4 ~ 91. 8	HN-219				FN-2305
	91. 8 ~ 93. 8	HN-351				FN-2305
3000 KZN130G, 130W	93. 8 ~ 95.11	HN-351				FN-2305
VZN130G	90. 8 ~ 91. 8	HN-219				FN-2305
	91. 8 ~ 95.11	HN-351				FN-2305
KZN185G, 185W	95.11 ~ 00. 8	HN-387				FN-2305
KDN185G, 185W	00. 8 ~ 02.11	HN-387				FN-2305
KDN215W	02.11 ~ 05. 8	HN-482		HN-243		
LN147	97. 8 ~ 04. 7	HN-227				FN-2330
LN167, 172H	97. 8 ~ 04. 7	HN-219				FN-2305
3400 VZN185W	95.11 ~ 02.11	HN-387				FN-2305
VZN180W	98. 7 ~ 00. 8	HN-387				FN-2305
VZN210W, 215W	02.11 ~ 05. 8	HN-482		HN-243		

- NISSAN
- TOYOTA (HINO)
- MAZDA
- ISUZU
- HONDA
- MITSUBISHI
- SUBARU
- SUZUKI
- DAIHATSU
- LEXUS
- INFINITY
- HYUNDAI
- KIA

TOYOTA - 32

- NISSAN
- TOYOTA**
(HINO)
- MAZDA
- ISUZU
- HONDA
- MITSUBISHI
- SUBARU
- SUZUKI
- DAIHATSU
- LEXUS
- INFINITI
- HYUNDAI
- KIA

Model 車種形式	Year 年式	Front フロント		Rear リア		Parking パーキング
		Pad パッド	Shoe シュー	Pad パッド	Shoe シュー	Shoe シュー
HILUX・HILUXSURF						
4000 GRN215W	05. 8 ~ 09. 8	HN-482		HN-243		
HILUX VIGO						
2500 TGN16, 26 (4X2)		HN-709			FN-2335	
KUN15 (4X2)					FN-2395	
GGN15 (4X2)		HN-710			FN-2395	
KUN20 (4X4)					FN-2395	
KUN25 (4X4)					FN-2395	
GGN25 (4X4)					FN-2395	
INNOVA						
2700 TGN40		HN-834				
FORTUNER						
2700 GGN50, 60					FN-2395	
TGN51, 61						
PASSO						
1000 KGC10	04. 6 ~ 10. 2	HN-492			FN-0042	
KGC15	04. 6 ~ 10. 2	HN-492			FN-0030	
KGC30	10. 2 ~ 16. 4	HN-492			FN-0042	
KGC35 4WD X	10. 2 ~ 16. 4	HN-492			FN-0043	
4WD+NANA	10. 2 ~ 16. 4	HN-562			FN-0043	
1300 QNC10	04. 6 ~ 10. 2	HN-492			FN-0042	
NGC30	10. 2 ~ 16. 4	HN-492			FN-0042	
PASSO SETTE						
1500 M502E W/VSC	08.12 ~ 12. 3	HN-518			FN-2389	
W/O VSC	08.12 ~ 12. 3	HN-508			FN-2389	
M512E	08.12 ~ 12. 3	HN-518			FN-2389	
HARRIER						
2000 ZSU60W, 65W	13.12 ~	HN-530		HN-522		
2200 SXU10W, 15W	97.12 ~ 00.11	HN-401		HN-321		
2400 ACU10W, 15W	00.11 ~ 01. 8	HN-401		HN-321		
	01. 8 ~ 03. 2	HN-481		HN-321		
ACU30W, 35W	03. 2 ~	HN-497		HN-498		
2500 AVU65W	14. 1 ~	HN-530		HN-522		
3000 MCU10W, 15W	97.12 ~ 01. 8	HN-401		HN-321		
	01. 8 ~ 03. 2	HN-481		HN-321		
MCU30W, 35W	03. 2 ~ 06. 1	HN-497		HN-498		
MCU31W, 36W	03. 2 ~ 06. 1	HN-497		HN-498		
3300 MHU38W HYBRID	05. 3 ~ 12. 6	HN-497		HN-498		

TOYOTA - 33

Model 車種形式	Year 年式	Front フロント		Rear リア		Parking パーキング
		Pad パッド	Shoe シュー	Pad パッド	Shoe シュー	Shoe シュー
HARRIER						
3500 GSU30W, 35W	06. 1 ~ 12. 6	HN-497		HN-498		
GSU31W, 36W	06. 1 ~ 12. 6	HN-497		HN-498		
VISTA・VISTA ARDEO						
1800 ZZV50, 50G	98. 6 ~ 00. 4	HN-322			FN-2342	
	00. 4 ~ 03. 7	HN-472			FN-2342	
VISTA・VISTA ARDEO						
2000 SV50	98. 6 ~ 01. 8	HN-430		HN-431		
SV55, 55G	98. 6 ~ 02. 4	HN-430		HN-431		
AZV50, 50G	01. 8 ~ 03. 7	HN-430		HN-431		
AZV55, 55G	02. 4 ~ 03. 7	HN-430		HN-431		
FUNCARGO						
1300 NCP20	99. 8 ~ 04.11	HN-472			FN-2342	
	04.11 ~ 05. 9	HN-540			FN-2342	
1500 NCP21, 25	99. 8 ~ 04.11	HN-472			FN-2342	
	04.11 ~ 05. 9	HN-540			FN-2342	
PLATZ						
1000 SCP11	99. 8 ~ 05.10	HN-471			FN-2350	
1300 NCP16 4WD	99. 8 ~ 05.10	HN-471			FN-2342	
1500 NCP12	99. 8 ~ 05.10	HN-471			FN-2350	
PRIUS						
1500 NHW10	97.12 ~ 00. 5	HN-322			FN-2342	
NHW11 REAR DRUM	00. 5 ~ 03. 8	HN-472			FN-2342	
NHW11 REAR DISC	01. 8 ~ 03. 8	HN-472		HN-454		
NHW20	03. 9 ~ 09. 5	HN-472			FN-2342	
	09. 6 ~ 11.12	HN-472			FN-2383	
1800 ZVW30	09. 4 ~	HN-567		HN-568		
ZVW35	12. 1 ~	HN-567		HN-568		
ZVW50, ZVW51, ZVW55	15.12 ~	HN-567		HN-568		
PRIUS α						
1800 ZVW40W, 41W	11. 5 ~	HN-524		HN-569		
BLADE						
2400 AZE156H	06.12 ~ 12. 4	HN-524		HN-519		
AZE154H 4WD	06.12 ~ 12. 4	HN-524		HN-519		
3500 GRE156H MASTER	07. 8 ~ 12. 4	HN-530		HN-519		
BREVIS						
2500 JCG10	01. 5 ~ 07. 6	HN-442		HN-421		
JCG15 4WD	01. 5 ~ 07. 6	HN-228		HN-421		

- NISSAN
- TOYOTA (HINO)
- MAZDA
- ISUZU
- HONDA
- MITSUBISHI
- SUBARU
- SUZUKI
- DAIHATSU
- LEXUS
- INFINITY
- HYUNDAI
- KIA

TOYOTA - 34

- NISSAN
- TOYOTA**
(HINO)
- MAZDA
- ISUZU
- HONDA
- MITSUBISHI
- SUBARU
- SUZUKI
- DAIHATSU
- LEXUS
- INFINITI
- HYUNDAI
- KIA

Model 車種形式	Year 年式	Front フロント		Rear リア		Parking パーキング
		Pad パッド	Shoe シュー	Pad パッド	Shoe シュー	Shoe シュー
BREVIS						
3000 JCG11	01. 5 ~ 07. 6	HN-442		HN-421		
PREMIO・ALION						
1500 NZT240	01.12 ~ 07. 6	HN-472			FN-2342	
NZT260	07. 6 ~	HN-508			FN-2383	
16inch	07. 6 ~	HN-524			FN-2383	
1800 ZZT240	01.12 ~ 07. 6	HN-472			FN-2342	
ZZT245 4WD	01.12 ~ 07. 6	HN-430			FN-2358	
ZRT260	07. 6 ~	HN-524			FN-2383	
ZRT265	07. 6 ~	HN-524			FN-2389	
2000 AZT240	01.12 ~ 07. 6	HN-430			FN-2358	
ZRT261	07. 6 ~	HN-524			FN-2389	
PROGRES						
2500 JCG10	98. 5 ~ 01. 4	HN-228		HN-421		
	01. 4 ~ 07. 6	HN-442		HN-421		
JCG15 4WD	99.12 ~ 07. 6	HN-228		HN-421		
3000 JCG11	98. 5 ~ 01. 4	HN-228		HN-421		
	01. 4 ~ 07. 6	HN-442		HN-421		
PRONARD						
3000 MCX20	00. 2 ~ 03. 1	HN-401				
PROBOX・SUCCED						
1300 NCP50V	02. 6 ~ 14	HN-471			FN-2358	
NSP160V	14. 8 ~	HN-508			FN-2358	
1400 NLP51V	02. 6 ~ 14	HN-471			FN-2358	
1500 NCP51V	02. 6 ~	HN-471			FN-2358	
NCP52V	03. 4 ~	HN-471			FN-2358	
NCP55V	02. 6 ~	HN-471			FN-2358	
NCP58G, 59G TX G PACKAGE LIMITED	02. 6 ~ 04.11	HN-472			FN-2358	
TX G PACKAGE LIMITED	04.11 ~ 10. 6	HN-540			FN-2358	
W/O THE ABOVE	02. 6 ~ 10. 6	HN-471			FN-2358	
	10. 6 ~	HHN-471 or 472			FN-2358	
NCP160V, 165V	14. 8 ~	HN-508			FN-2358	
BELTA						
1000 KSP92	05.11 ~ 12. 6	HN-508			FN-2383	
1300 SCP92	05.11 ~ 12. 6	HN-508			FN-2383	
W/VSC	05.11 ~ 12. 6	HN-518		HN-519		
NCP96 4WD	05.11 ~ 12. 6	HN-508			FN-2383	

TOYOTA - 35

Model 車種形式	Year 年式	Front フロント		Rear リア		Parking パーキング
		Pad パッド	Shoe シュー	Pad パッド	Shoe シュー	Shoe シュー
PORTE・SPADE						
1300 NNP10	04. 7 ~ 04. 9	HN-472			FN-2342	
	04. 9 ~ 12. 7	HN-540			FN-2342	
1500 NNP11	04. 7 ~ 04. 9	HN-472			FN-2342	
	04. 9 ~ 12. 7	HN-540			FN-2342	
	06. 1 ~ 12. 7	HN-540			FN-2342	
QUALIS						
2200 SXV20W	97. 4 ~ 99. 8	HN-322		HN-321		
	99. 8 ~ 01.12	HN-322		HN-431		
	97. 6 ~ 01.12	HN-401		HN-321		
2500 MCV21W	97. 4 ~ 99. 8	HN-401		HN-321		
	99. 8 ~ 01.12	HN-401		HN-431		
	97. 6 ~ 01.12	HN-401		HN-321		
3000 MCV20W	97. 4 ~ 99. 8	HN-401		HN-321		
	99. 8 ~ 01.12	HN-401		HN-431		
MARK II・CHASER・CRESTA						
1800 SX80	88. 8 ~ 95.12	HN-246			FN-2232	
	92.10 ~ 96. 9	HN-322		HN-323		
	97. 4 ~ 98. 8	HN-322		HN-409		
		98. 8 ~ 01. 6	HN-434		HN-409	
2000 GX70G	84.11 ~ 97. 4	HN-071			FN-2232	
	88. 8 ~ 95.12	HN-246		HN-142C		
	92.10 ~ 96. 9	HN-322		HN-323		
	93. 2 ~ 97. 4	HN-071			FN-2232	
	88. 8 ~ 95.12	HN-246			FN-2232	
	96. 9 ~ 98. 8	HN-322		HN-409		
	98. 8 ~ 00.10	HN-434		HN-409		
	98. 8 ~ 00.10	HN-228		HN-363		
	00.10 ~ 07. 6	HN-442		HN-421		
	00.10 ~ 07. 6	HN-228		HN-421		
2400 LX76V	84.11 ~ 94. 9	HN-071			FN-2232	
	88. 8 ~ 93. 8	HN-246			FN-2232	
	92.10 ~ 96. 9	HN-322		HN-323		
	96. 9 ~ 98. 8	HN-322		HN-409		
	98. 8 ~ 99. 8	HN-434		HN-409		
2500 JZX81	90. 8 ~ 93. 2	HN-246		HN-142C		
	92.10 ~ 95. 9	HN-228		HN-323		
	95. 9 ~ 96. 9	HN-228		HN-363		
	92.10 ~ 96. 9	HN-324		HN-323		
	93.10 ~ 95. 9	HN-228		HN-323		
	95. 9 ~ 96. 9	HN-228		HN-363		
	96. 9 ~ 00.10	HN-228		HN-363		
	96. 9 ~ 00.10	HN-228		HN-363		
	96. 9 ~ 00.10	HN-228		HN-363		
	96. 9 ~ 00.10	HN-228		HN-363		

- NISSAN
- TOYOTA (HINO)
- MAZDA
- ISUZU
- HONDA
- MITSUBISHI
- SUBARU
- SUZUKI
- DAIHATSU
- LEXUS
- INFINITY
- HYUNDAI
- KIA

TOYOTA - 36

- NISSAN
- TOYOTA**
(HINO)
- MAZDA
- ISUZU
- HONDA
- MITSUBISHI
- SUBARU
- SUZUKI
- DAIHATSU
- LEXUS
- INFINITI
- HYUNDAI
- KIA

Model 車種形式	Year 年式	Front フロント		Rear リア		Parking パーキング
		Pad パッド	Shoe シュー	Pad パッド	Shoe シュー	Shoe シュー
MARK II · CHASER · CRESTA						
2500 JZX100 TOURER . V , ROULANT . G	96. 9 ~ 00.10	HN-324		HN-409		
JZX105	96. 9 ~ 00.10	HN-228		HN-363		
JZX110, 110W	00.10 ~ 07. 6	HN-442		HN-421		
TURBO	00.10 ~ 07. 6	HN-324		HN-421		
JZX115, 115W	00.10 ~ 07. 6	HN-228		HN-421		
3000						
MX83	89. 8 ~ 93. 2	HN-246		HN-142C		
JZX91	92.10 ~ 95. 9	HN-228		HN-323		
	95. 9 ~ 96. 9	HN-228		HN-363		
JZX101	96. 9 ~ 00.10	HN-228		HN-363		
MARK X						
2500						
GRX120, 125	04.11 ~ 09.10	HN-550		HN-494		
GRX120 S PACKAGE, W/18-INCH WHEEL	04.11 ~ 09.10	HN-479		HN-494		
GRX130	09.10 ~ 14. 7	HN-550		HN-494		
GRX130 PREMIUM, S PACKAGE, 250G	14. 7 ~	HN-550				
GRX135	09.10 ~	HN-550		HN-494		
3000						
GRX121	04.11 ~ 09.10	HN-550		HN-494		
PREMIUM, S PACKAGE, W/18-INCH WHEEL	04.11 ~ 09.10	HN-479		HN-494		
3500						
GRX133	09.10 ~ 13. 8	HN-547		HN-494		
PREMIUM, S PACKAGE, 350G	13. 8 ~	HN-547				
MARK X ZIO						
2400						
ANA10	07. 9 ~	HN-530		HN-522		
ANA15	07. 9 ~	HN-530		HN-522		
MARK X ZIO						
3500						
GGA10	07. 9 ~	HN-530		HN-522		
MASTERACE SURF						
1800						
YR20G, 28G	82.11 ~ 92. 1	HN-216			FN-2232	
2000						
CR21G, 28G	83. 4 ~ 92. 1	HN-216			FN-2232	
CR30G, 37G	85.10 ~ 92. 1	HN-218			FN-2252	
YR21G	83. 5 ~ 92. 1	HN-216			FN-2232	
YR30G, 36G	85.10 ~ 92. 1	HN-218			FN-2252	
MEGA CRUISER						
4100						
BXD20V	96. 1 ~ 01.10	HN-393		HN-394		
LITE · TOWNACE NOAH						
2000						
SR40G	96.10 ~ 01.11	HN-404			FN-2339	
SR50G	96.10 ~ 98.12	HN-405			FN-2335A	
SIX-SEATER	98.12 ~ 01.11	HN-405			FN-2335A	
SEVEN/EIGHT-SEATER	98.12 ~ 01.11	HN-404			FN-2335A	
2200						
CR40G	96.10 ~ 01.11	HN-404			FN-2339	

TOYOTA - 37

Model 車種形式	Year 年式	Front フロント		Rear リア		Parking パーキング
		Pad パッド	Shoe シュー	Pad パッド	Shoe シュー	Shoe シュー
LITE・TOWNACE NOAH						
2200 CR50G	96.10 ~ 98.12	HN-405				FN-2335A
	98.12 ~ 01.11	HN-404				FN-2335A
LITE ACE						
1500 KM30G	85.9 ~ 92.1	HN-216				FN-2232
KM31V, 36V	85.9 ~ 92.1	HN-216				FN-2232
KM51	86.10 ~ 99.2	HN-216				FN-2232
KR27V	92.1 ~ 96.10	HN-328				FN-2232
KR41V	96.11 ~ 98.12	HN-404				FN-2339
S402M, U, S412M, U	08.1 ~	HN-552				FN-2398
1800 YM30G	85.9 ~ 92.1	HN-216				FN-2232
YM31V	90.8 ~ 92.1	HN-216				FN-2232
YM55	86.10 ~ 99.2	HN-216				FN-2232
	99.2 ~ 99.6	HN-216				FN-2339
YM60, 65	86.10 ~ 99.6	HN-217				FN-2252
YR25V	92.1 ~ 96.10	HN-328				FN-2232
KR42V	96.11 ~ 07.8	HN-404				FN-2339
KM70	99.6 ~ 07.8	HN-404				FN-2339
KM75	99.6 ~ 07.8	HN-404				FN-2339
CAMPER BASED	02.8 ~ 07.8	HN-503				FN-2335A
KM80, 85	99.6 ~ 07.8	HN-503				FN-2335A
2000 CM30G	85.9 ~ 92.1	HN-216				FN-2232
CM31V, 36V	85.9 ~ 92.1	HN-216				FN-2232
CM40G, 41V	85.10 ~ 92.1	HN-217				FN-2252
CM51	86.10 ~ 99.2	HN-216				FN-2232
CM51	99.2 ~ 99.6	HN-216				FN-2339
CM55	86.10 ~ 99.2	HN-216				FN-2232
	99.2 ~ 99.6	HN-216				FN-2339
AERIAL WORK PLATFORMS	94.4 ~ 99.6	HN-328				FN-2252
CM52	91.10 ~ 99.6	HN-217				FN-2317
CM60	86.10 ~ 99.6	HN-217				FN-2252
CM65	86.10 ~ 99.6	HN-217				FN-2252
AERIAL WORK PLATFORMS	96.11 ~ 99.6	HN-327				FN-2330
CM61	91.10 ~ 99.6	HN-217				FN-2317
CR21G LD	W/O ABS	92.1 ~ 93.9	HN-328			FN-2232
GXL	W/ ABS	92.1 ~ 93.9	HN-328			FN-2252
CR27V		92.1 ~ 96.10	HN-328			FN-2232
CR28G		92.1 ~ 93.9	HN-327			FN-2232
CR30G, 37G		92.1 ~ 93.9	HN-327			FN-2252
CR36V		92.1 ~ 96.10	HN-327			FN-2252
YM40G		85.10 ~ 92.1	HN-217			FN-2252
YR21G LD	W/O ABS	92.1 ~ 96.10	HN-328			FN-2232
GXL	W/ ABS	92.1 ~ 96.10	HN-328			FN-2252
YR30G		92.1 ~ 96.10	HN-327			FN-2252
CR31G, 38G		93.9 ~ 96.10	HN-327			FN-2252
CR41V		96.11 ~ 98.12	HN-404			FN-2339
CR51V		96.11 ~ 98.12	HN-405			FN-2335A

- NISSAN
- TOYOTA (HINO)
- MAZDA
- ISUZU
- HONDA
- MITSUBISHI
- SUBARU
- SUZUKI
- DAIHATSU
- LEXUS
- INFINITY
- HYUNDAI
- KIA

TOYOTA - 38

- NISSAN
- TOYOTA
(HINO)
- MAZDA
- ISUZU
- HONDA
- MITSUBISHI
- SUBARU
- SUZUKI
- DAIHATSU
- LEXUS
- INFINITI
- HYUNDAI
- KIA

Model 車種形式	Year 年式	Front フロント		Rear リア		Parking パーキング
		Pad パッド	Shoe シュー	Pad パッド	Shoe シュー	Shoe シュー
LITE ACE						
2200 CR22G, 29G MT	93. 9 ~ 96. 10	HN-328			FN-2252	
AT	93. 9 ~ 96. 10	HN-328			FN-2232	
CR31G, 38G	93. 9 ~ 96. 10	HN-327			FN-2252	
CR42V	98. 12 ~ 04. 7	HN-404			FN-2339	
CR52V	98. 12 ~ 04. 7	HN-405			FN-2335A	
CM70, 75	99. 6 ~ 04. 8	HN-404			FN-2339	
CM75 YAMATO SPEC	99. 6 ~ 04. 8	HN-404			FN-2252	
CAMPER-BASED	02. 8 ~ 04. 8	HN-503			FN-2335A	
CM80, 85	99. 6 ~ 04. 8	HN-503			FN-2335A	
CM85 YAMATO SPEC	99. 6 ~ 02. 8	HN-273			FN-2330	
RAUM						
1500 EXZ10	97. 5 ~ 03. 4	HN-077C			FN-2311	
EXZ15	97. 8 ~ 03. 4	HN-077C			FN-2313	
NCZ20, 25	03. 4 ~ 04. 9	HN-472			FN-2342	
	04. 9 ~ 11. 10	HN-540			FN-2342	
RACTIS						
1300 SCP100	05. 10 ~ 10. 11	HN-518			FN-2389	
1500 NCP100	05. 10 ~ 10. 11	HN-518			FN-2389	
S PACKAGE	05. 10 ~ 10. 11	HN-518		HN-519	FN-2389	
NCP105 4WD	05. 10 ~ 10. 11	HN-518			FN-2389	
RUSH						
1500 J200E	06. 1 ~	HN-416			FN-2339	
J210E	06. 1 ~	HN-416			FN-2339	
LAND CRUISER						
2400 LJ71G	90. 4 ~ 93. 5	HN-350		HN-243		
LJ78G, 78W	90. 4 ~ 93. 5	HN-219		HN-243		
3500 PZJ70, 70V	90. 1 ~ 94. 1	HN-219			FN-2280	
PZJ77V, 77HV	90. 4 ~ 94. 1	HN-219			FN-2280	
4000 FJ75	90. 1 ~ 92. 8	HN-219			FN-2280	
FJ80G	90. 1 ~ 92. 8	HN-242		HN-243		
GRJ76K, 79K	14. 8 ~ 15. 7	HN-411		HN-243		
4200 HZJ70, 70V	94. 1 ~ 99. 8	HN-219			FN-2280	
HZJ71V	99. 8 ~ 04. 8	HN-411			FN-2280	
HZJ73V ZX	90. 5 ~ 99. 8	HN-219		HN-243		
LX	94. 1 ~ 99. 8	HN-219			FN-2280	
HZJ73HV	90. 1 ~ 99. 8	HN-219		HN-243		
HZJ74K	99. 8 ~ 04. 8	HN-411		HN-243		
HZJ74V	99. 8 ~ 04. 8	HN-411			FN-2280	
HZJ75	92. 12 ~ 99. 8	HN-219			FN-2280	
HZJ76K	99. 8 ~ 04. 8	HN-411		HN-243	FN-2280	
HZJ76V	99. 8 ~ 04. 8	HN-411			FN-2280	

TOYOTA - 39

Model 車種形式	Year 年式	Front フロント		Rear リア		Parking パーキング
		Pad パッド	Shoe シュー	Pad パッド	Shoe シュー	Shoe シュー
LAND CRUISER						
4200 HZJ77V	94. 1 ~ 99. 8	HN-219			FN-2280	
HZJ77HV ZX	90. 4 ~ 99. 8	HN-219		HN-243		
LX	94. 1 ~ 99. 8	HN-219			FN-2280	
HZJ79	99.11 ~ 04. 8	HN-411			FN-2280	
HZJ81V	90. 1 ~ 98. 1	HN-242		HN-243	FN-2280	
HDJ81V	90. 1 ~ 98. 1	HN-242		HN-243		
HDJ101K	98. 1 ~ 07. 9	HN-411		HN-412		
4500 FZJ80G	92. 8 ~ 98. 1	HN-242		HN-243	FN-2280	
4600 UZJ202W	09. 5 ~	HN-541		HN-542		
4700 UZJ100W	98. 1 ~ 07. 9	HN-411		HN-412		
UZJ200W	07. 9 ~	HN-541		HN-542		
LAND CRUISER PRADO						
2400 LJ71G	90. 4 ~ 93. 5	HN-086		HN-243		
LJ78G, 78W	90. 4 ~ 93. 5	HN-219		HN-243		
2700 RZJ90W, 95W	96. 4 ~ 02. 9	HN-387		HN-243		
RZJ120W, 125W	02. 9 ~ 04. 8	HN-482		HN-243		
TRJ120W, 125W	04. 8 ~ 09. 8	HN-482		HN-243		
TRJ150W	09. 8 ~	HN-482		HN-243		
3000 KZJ71G, 71W	93. 5 ~ 96. 4	HN-219		HN-243		
KZJ78G, 78W	93. 5 ~ 96. 4	HN-219		HN-243		
KZJ90W, 95W	96. 4 ~ 00. 8	HN-387		HN-243		
KDJ90W, 95W	00. 8 ~ 02.11	HN-387		HN-243		
KDJ120W	02.11 ~ 07. 7	HN-482		HN-243		
KDJ121W, 125W	02.11 ~ 05. 8	HN-482		HN-243		
3400 VZJ90W, 95W	96. 4 ~ 02. 9	HN-387		HN-243		
VZJ120W, 121W	02. 9 ~ 05. 8	HN-482		HN-243		
VZJ125W	02. 9 ~ 05. 8	HN-482		HN-243		
4000 GRJ120W, 121W	05. 8 ~ 09. 8	HN-482		HN-243		
GRJ150W, 151W	09. 9 ~	HN-482		HN-243		
LEXUS GS						
3500 GRS191, 196 GS350	05. 8 ~ 12. 1	HN-547		HN-494		
GWS191 GS450H	06. 2 ~ 12. 1	HN-547		HN-494		
4300 UZS190 GS430	05. 8 ~ 07. 9	HN-547		HN-494		
4600 URS190 GS460	07. 9 ~ 12. 1	HN-547		HN-494		
LEXUS HS						
2400 ANF10	09. 7 ~	HN-524		HN-522		

- NISSAN
- TOYOTA (HINO)
- MAZDA
- ISUZU
- HONDA
- MITSUBISHI
- SUBARU
- SUZUKI
- DAIHATSU
- LEXUS
- INFINITY
- HYUNDAI
- KIA

TOYOTA - 40

- NISSAN
- TOYOTA
(HINO)
- MAZDA
- ISUZU
- HONDA
- MITSUBISHI
- SUBARU
- SUZUKI
- DAIHATSU
- LEXUS
- INFINITY
- HYUNDAI
- KIA

Model 車種形式	Year 年式	Front フロント		Rear リア		Parking パーキング
		Pad パッド	Shoe シュー	Pad パッド	Shoe シュー	Shoe シュー
LEXUS IS						
2500 GSE20, 25 IS250	05. 8 ~ 13. 5			HN-494		
3500 GSE21 IS350	05. 8 ~ 13. 5	HN-547		HN-494		
5000 USE20 IS F	07.12 ~ 13. 5					
LEXUS LS						
4600 USF40, 41 LS460	06. 8 ~					
USF45, 46 LS460	06. 8 ~					
5000 UVF45, 46 LS600H	07. 4 ~					
LEXUS RX						
3500 GGL10W, 15W, 16W RX350	08.12 ~			HN-569		
GYL15W, 16W RX450	08.12 ~			HN-569		
LEXUS SC						
4300 UZZ40 SC430	05. 8 ~ 10. 7	HN-324		HN-421		FN-2392
REGIUS · TOURING HIACE						
2000 RCH42V	97. 6 ~ 02. 5	HN-237			FN-2330	
2700 RCH41W, 47W	97. 4 ~ 02. 5	HN-237		HN-363		
3000 KCH40G, 46G	97. 4 ~ 99. 7	HN-237		HN-363		
KCH40W, 46W	97. 4 ~ 02. 5	HN-237		HN-363		
LXH43V, 49V	97. 6 ~ 02. 5	HN-237			FN-2330	

MAZDA - 1

Model 車種形式			Year 年式	Front フロント		Rear リア		Parking パーキング
				Pad パッド	Shoe シュー	Pad パッド	Shoe シュー	Shoe シュー
A Z - 1								
660	PG6SA		92.10 ~ 96.5	HN-183		HN-130		
A Z - 3								
1500	EC5SA		91.6 ~ 93.10	HN-230		HN-198	FN-3385	
			93.9 ~ 98.1	HN-230		HN-353		
1800	ECPSA		93.9 ~ 98.1	HN-230		HN-353		
AZ OFF-ROAD								
660	JM23W		98.10 ~ 14.3	HN-118			FN-5524	
AZ WAGON								
660	CY21S	ZG,ZX	No. ~110000	94.7 ~ 95.10	HN-183		FN-9931	
		ZG,ZX,FG,FX	No.110001~	95.10 ~ 97.4	HN-378		FN-9944	
		FXLTD	No.600001~	96.6 ~ 97.4	HN-378		FN-9944	
		TURBO		95.10 ~ 98.6	HN-213		FN-9944	
	CZ21S	ZG-4	No. ~110000	94.7 ~ 95.10	HN-183		FN-9928	
		ZG-4S W/O ABS	No.110001~	95.10 ~ 98.6	HN-378		FN-9944	
		ZG-4S W/ ABS	No.120001~	97.4 ~ 98.6	HN-213		FN-9944	
		FXLTD	No.600001~	96.6 ~ 97.4	HN-378		FN-9944	
		TURBO		95.10 ~ 98.6	HN-213		FN-9944	
	CY51S,CZ51S	FX,FM,ZX W/O ABS		97.4 ~ 98.9	HN-378		FN-9944	
		FX W/ ABS		97.4 ~ 98.9	HN-213		FN-9944	
		TURBO		97.4 ~ 98.9	HN-213		FN-9944	
	MD11S,MD21S			98.10 ~ 00.11	HN-426		FN-9959	
	MD12S			00.12 ~ 01.10	HN-426		FN-9959	
	MD22S			00.12 ~ 03.9	HN-426		FN-9959	
	MJ21S		No. ~300000	03.10 ~ 04.12	HN-426		FN-9967	
		W/ TURBO	No.300001~	04.12 ~ 05.8	HN-426		FN-9967	
		W/O TURBO	No.300001~	04.12 ~ 07.5	HN-566		FN-9967	
			No.420001~	05.9 ~ 07.5	HN-566		FN-9967	
	MJ22S			07.5 ~ 08.9	HN-566		FN-9967	
	MJ23S	EXCL.2WDXT.4WDXF.XG-B.XG W/O ABS		08.9 ~ 12.9	HN-566		FN-9967	
C X - 7								
2300	ER3P		06.12 ~ 11.12	HN-561		HN-564		
J 8 0								
1400	SE48TF		SINGLE TYRE	83.9 ~ 90.6		FN-3327	FN-3348	
			DOUBLE TYRES	83.9 ~ 90.6		FN-3327	FN-3351	
	SS48VF	No. ~200188	SINGLE TYRE	83.9 ~ 90.6	HN-211		FN-3348	
			DOUBLE TYRES	83.9 ~ 90.6	HN-211		FN-3351	
		No.200189~	SINGLE TYRE	83.9 ~ 90.6	HN-211		FN-3348	
			DOUBLE TYRES	83.9 ~ 90.6	HN-211		FN-3351	
1500	SE58TF			90.7 ~ 95.9	HN-211	FN-3327	FN-3351	
	SS58VF			90.7 ~ 95.9	HN-211		FN-3348	
1800	SS88HF	MT		96.9 ~ 99.5	HN-211		FN-3351	

- NISSAN
- TOYOTA
(HINO)
- MAZDA
- ISUZU
- HONDA
- MITSUBISHI
- SUBARU
- SUZUKI
- DAIHATSU
- LEXUS
- INFINITY
- HYUNDAI
- KIA

MAZDA - 2

- NISSAN
- TOYOTA
(HINO)
- MAZDA**
- ISUZU
- HONDA
- MITSUBISHI
- SUBARU
- SUZUKI
- DAIHATSU
- LEXUS
- INFINITI
- HYUNDAI
- KIA

Model 車種形式	Year 年式	Front フロント		Rear リア		Parking パーキング
		Pad パッド	Shoe シュー	Pad パッド	Shoe シュー	Shoe シュー
J 8 0						
1800 SS88HF AT	96. 9 ~ 99. 5	HN-211			FN-3348	
SS88MF 4WD	83. 9 ~ 90. 6	HN-211			FN-3348	
SS88RF 4WD	83. 9 ~ 90. 6	HN-211			FN-3348	
SS88VF SINGLE TYRE	96. 9 ~ 99. 5	HN-211			FN-3348	
DOUBLE TYRES	96. 9 ~ 99. 5	HN-211			FN-3351	
SE88TF	95. 8 ~ 99. 5	HN-211			FN-3351	
2000 SEF8TF SINGLE TYRE	83.12 ~ 93. 8		FN-3327		FN-3348	
DOUBLE TYRES	83.12 ~ 93. 8		FN-3327		FN-3351	
SSF8VF SINGLE TYRE	83. 9 ~ 95. 9	HN-211			FN-3348	
DOUBLE TYRES	83. 9 ~ 95. 9	HN-211			FN-3351	
2200 SS28HF SINGLE TYRE	96. 9 ~ 99. 5	HN-211			FN-3348	
DOUBLE TYRES	96. 9 ~ 99. 5	HN-211			FN-3351	
SS28MF	86.11 ~ 99. 5	HN-211			FN-3348	
SS28VF SINGLE TYRE	93. 8 ~ 99. 5	HN-211			FN-3348	
DOUBLE TYRES	93. 8 ~ 99. 5	HN-211			FN-3351	
SE28TF	93. 9 ~ 99. 5	HN-211			FN-3351	
SE28MF	96. 9 ~ 99. 5	HN-211			FN-3350	
J 1 0 0						
2000 SDEATF	84. 1 ~ 97. 5	HN-211	FN-3355		FN-3350	
SREAVF	84. 1 ~ 95. 9	HN-211	FN-3355		FN-3349	
2200 SD2ATF	87. 9 ~ 97. 5	HN-211	FN-3355		FN-3350	
SD29MF	87. 9 ~ 97. 5	HN-211	FN-3355		FN-3350	
SR2AVF	87. 9 ~ 97. 5	HN-211	FN-3355		FN-3349	
SR2AMF	87. 9 ~ 97. 5	HN-211	FN-3355		FN-3349	
2500 SR5AVF	97. 4 ~ 99. 6	HN-211			FN-3349	
SR5AMF	97. 4 ~ 99. 6	HN-211			FN-3349	
SD5ATF	97. 4 ~ 99. 6	HN-211			FN-3350	
3000 SRSAVF	92. 7 ~ 97. 4	HN-211			FN-3350	
M P V						
2000 LWEW No. ~151107	99. 5 ~ 02. 4	HN-459			FN-3402	
No. 151108~	99. 5 ~ 02. 4	HN-459			FN-3411	
2300 LW3W	02. 3 ~ 06. 2	HN-459			FN-3411	
LY3P	06. 2 ~	HN-561		HN-564		
2500 LV5W	94.12 ~ 99. 5	HN-376		HN-290		
LVLR, LVLW	95.10 ~ 99. 5	HN-376		HN-290		
LW5W No. ~202360	99. 5 ~ 02. 4	HN-459			FN-3402	
No. 202361~	99. 5 ~ 02. 4	HN-459			FN-3411	
3000 LVEW REAR DRUM	89. 1 ~ 91. 8	HN-303			FN-3378	
REAR DRUM	91. 8 ~ 95.10	HN-332			FN-3378	

MAZDA - 3

Model 車種形式	Year 年式	Front フロント		Rear リア		Parking パーキング
		Pad パッド	Shoe シュー	Pad パッド	Shoe シュー	Shoe シュー
MPV						
3000 LVEW REAR DISC	91. 8 ~ 99. 5	HN-376		HN-290		
LWFW	02. 3 ~ 06. 2	HN-459			FN-3411	
MS-6						
1800 GE8P	91.10 ~ 94. 7	HN-239		HN-238		
2000 GEEP	91.10 ~ 94. 7	HN-239		HN-238		
GESR	92. 4 ~ 94. 7	HN-239		HN-203		
GEFP	93. 6 ~ 94. 7	HN-239		HN-238		
MS-8						
2000 MBEP	92. 1 ~ 98. 2	HN-239		HN-238		
2500 MB5A, MB5P	92. 1 ~ 98. 2	HN-239		HN-238		
MS-9						
2500 HD5S	91. 9 ~ 93.12	HN-294		HN-290		
3000 HDES	91. 9 ~ 93.12	HN-294		HN-290		
MX-6						
2000 GEEB, GEES	91.11 ~ 96. 1	HN-239		HN-238		
2500 GE5B, GE5S	91.11 ~ 96. 1	HN-239		HN-238		
RX-7						
1300 FC3S No.11985~	85. 9 ~ 91.10	HN-316		HN-203		
FC3C CABRIOLET	87. 8 ~ 92.12	HN-316		HN-203		
FD3S	91.10 ~ 02. 8	HN-316		HN-203		
RX-8						
1300 SE3P	03. 5 ~ 12. 6					
AXELA						
1500 BK5P	03.10 ~ 09. 6	HN-507		HN-578	FN-3427	
BL5FP, BL5FW	09. 6 ~ 13.11	HN-507				
1600 BF6FJ	09. 4 ~ 13.11	HN-507		HN-578		
2000 BKEP	03.10 ~ 09. 6	HN-507		HN-578	FN-3427	
BLEAP, BLEAW	09. 6 ~ 13.11	HN-507		HN-578		
BLEFP, BLEFW	09. 6 ~ 13.11	HN-507		HN-578		
2300 BK3P W/O TURBO	03.10 ~ 09. 6	HN-507			FN-3427	
W/TURBO	06. 5 ~ 09. 6					
BL3FW	09. 6 ~ 13.11			HN-578		
ATENZA						
2000 GGEP, GGES	02. 5 ~ 07.12	HN-483		HN-203		

- NISSAN
- TOYOTA (HINO)
- MAZDA
- ISUZU
- HONDA
- MITSUBISHI
- SUBARU
- SUZUKI
- DAIHATSU
- LEXUS
- INFINITI
- HYUNDAI
- KIA

MAZDA - 4

- NISSAN
- TOYOTA
(HINO)
- MAZDA**
- ISUZU
- HONDA
- MITSUBISHI
- SUBARU
- SUZUKI
- DAIHATSU
- LEXUS
- INFINITI
- HYUNDAI
- KIA

Model 車種形式	Year 年式	Front フロント		Rear リア		Parking パーキング
		Pad パッド	Shoe シュー	Pad パッド	Shoe シュー	Shoe シュー
ATENZA						
2000 GYEW	02. 6 ~ 07.12	HN-483		HN-203		
GHEFP, GHEFS	08. 1 ~ 12.11	HN-563		HN-203		
GHEFW	08. 1 ~ 12.11	HN-563		HN-203		
2300						
GG3P	02. 5 ~ 07.12	HN-483		HN-203		
GG3S	23C W/O 18inch WHEEL	02. 5 ~ 07.12	HN-483	HN-203		
	23Z 18inch WHEEL	02. 5 ~ 05. 4	HN-526	HN-203		
GY3W	23C W/O 18inch WHEEL	02. 6 ~ 07.12	HN-483	HN-203		
	23C, 23Z 18inch WHEEL	02. 6 ~ 05. 4	HN-526	HN-203		
2500						
GH5FP	08. 1 ~ 12.11	HN-563		HN-203		
GH5FS, GH5FW	25S, 25EX	08. 1 ~ 12.11	HN-563	HN-203		
	25Z 18inch WHEEL	08. 1 ~ 12.11	HN-563	HN-203		
GH5AP, GH5AS	08. 1 ~ 12.11	HN-563		HN-203		
GH5AW	08. 1 ~ 12.11	HN-563		HN-203		
IXION						
1800 CP8WF	2WD	99. 4 ~ 03. 1	HN-239		HN-203	FN-3382
	4WD	99. 4 ~ 03. 1	HN-239		HN-203	
ESCAPE						
2000 EPEWF, EPFWF	00.11 ~					
ETUDE						
1500 BFSP	88. 2 ~ 90. 8	HN-138			FN-3356	
1600 BFMP	87. 1 ~ 90. 8	HN-138		HN-353		
CUSTOM CAB						
2000 HBEY	89. 5 ~ 96. 1				FN-3365	
CAPELLA・CAPELLA CARGO						
1600 GC6P	82. 9 ~ 87. 2				FN-3347	
	82. 9 ~ 87. 2	HN-155			FN-3347	
GD6P	87. 7 ~ 91.10	HN-194		HN-195	FN-3373	
GV6V	VAN	88. 1 ~ 99. 4	HN-194	HN-195	FN-3375	
1800						
GC8P	TAXI	83. 8 ~ 87. 6		FN-3353	FN-3379	
GD8A, GD8B	88. 2 ~ 91.10	HN-194		HN-195	FN-3372	
GD8J	TRAINING VEHICLES	87. 7 ~ 92. 1	HN-194		FN-3372	
GD8P	87. 5 ~ 91.10	HN-194		HN-195	FN-3373	
	EGI	87. 5 ~ 91.10	HN-194	HN-195	FN-3372	
GD8Y	TAXI	83. 8 ~ 87. 6	HN-194	FN-3380	FN-3375	
GD8R	89. 4 ~ 91.10	HN-194		HN-203	FN-3372	
GD8S	87. 5 ~ 91.10	HN-194		HN-195	FN-3372	
GD8Y	87. 7 ~ 92. 1	HN-194			FN-3375	
GV8W	STATION WAGON	88. 1 ~ 97.10	HN-194		HN-195	FN-3375
CG2PP	94. 7 ~ 97. 6	HN-239		HN-238	FN-3386	
GF8P	97. 6 ~ 02. 3	HN-239			FN-3386	

MAZDA - 5

Model 車種形式			Year 年式	Front フロント		Rear リア		Parking パーキング
				Pad パッド	Shoe シュー	Pad パッド	Shoe シュー	Shoe シュー
CAPELLA・CAPELLA CARGO								
1800	GW8W	STATION WAGON	No.100001~102554	97.10 ~ 99. 9	HN-239			FN-3391
			No.102555~106930	97.10 ~ 99. 9	HN-239			FN-3399
			No.106931~108439	97.10 ~ 99. 9	HN-239			FN-3999
			No.106440~109266	99. 9 ~ 02. 5	HN-239			FN-3999
			No.109268~	99. 9 ~ 02. 5	HN-239			FN-3382
2000	GCEP, GCFP		No. ~250000	82. 9 ~ 87. 2				FN-3347
			No.250001~	82. 9 ~ 87. 2	HN-155			FN-3347
	GDEA, GDEP			87. 5 ~ 91.10	HN-194		HN-195	FN-3372
	GDEB, GDES			88. 2 ~ 91.10	HN-194		HN-195	FN-3372
	GDER			87. 7 ~ 91.10	HN-194		HN-203	FN-3372
	GDFJ	TRAINING VEHICLES		87. 7 ~ 92. 1	HN-194			FN-3373
	GDFP			87. 7 ~ 91.10	HN-194		HN-195	FN-3372
	GVER	STATION WAGON (GT)		90. 8 ~ 94. 9	HN-194		HN-203	
		STATION WAGON (SV, SF)		94.10 ~ 97.10	HN-194		HN-203	
		STATION WAGON (FX, CR)		94.10 ~ 97.10	HN-331		HN-203	
	GVFV	VAN		88. 1 ~ 99. 4	HN-194		HN-195	FN-3375
	GVEW, GVFW	STATION WAGON		89. 5 ~ 97.10	HN-194		HN-195	
	GVFR	STATION WAGON		92. 8 ~ 97.10	HN-331		HN-203	
	CG2SP			94. 7 ~ 97. 6	HN-239		HN-238	
	CG2SR			94. 7 ~ 97. 6	HN-239		HN-203	
	GFEP			97. 6 ~ 99. 9	HN-239		HN-238	
		ZI	No.200001~	99. 9 ~ 02. 3	HN-239		HN-476	
	GFFP			98. 6 ~ 99.10	HN-239			
	GFER			97. 6 ~ 02. 3	HN-239		HN-203	
	GWEW	STATION WAGON		97.10 ~ 02. 5	HN-239		HN-203	
	GWER, GWFW	STATION WAGON		97.10 ~ 02. 5	HN-418		HN-203	
2500	GW5R	STATION WAGON		97.10 ~ 02. 5	HN-418		HN-203	
CAROL								
660	AA5PA, AA6PA	W/O ABS		90. 2 ~ 95.10	HN-183			FN-9931
		W/ ABS		90. 2 ~ 95.10	HN-213			FN-0032
		TURBO		90. 2 ~ 95.10	HN-213			FN-9931
	AA5RA, AA6RA	W/O ABS		90. 2 ~ 95.10	HN-182			FN-9928
		AT W/ ABS		92. 7 ~ 95.10	HN-182			FN-9928
		MT W/ ABS		92. 7 ~ 95.10	HN-182			FN-0032
	AC6P			95.10 ~ 98. 9	HN-378			FN-9944
		TURBO		95.10 ~ 98. 9	HN-213			FN-9944
	AC6R			95.10 ~ 98. 9	HN-378			FN-9944
	HB12S			98.10 ~ 00.11	HN-426			FN-9959
	HB22S			98.10 ~ 02. 4	HN-426			FN-9959
	HB23S			00.12 ~ 03. 8	HN-426			FN-9959
				03. 9 ~ 04. 9	HN-426			FN-9967
	HB24S			04. 9 ~ 05. 2	HN-426			FN-9967
				05. 2 ~ 09.12	HN-566			FN-9967
	HB25S			09.12 ~	HN-566			FN-9967
	HB35S	ECO		12.11 ~	HN-566			

- NISSAN
- TOYOTA
(HINO)
- MAZDA
- ISUZU
- HONDA
- MITSUBISHI
- SUBARU
- SUZUKI
- DAIHATSU
- LEXUS
- INFINITI
- HYUNDAI
- KIA

MAZDA - 6

- NISSAN
- TOYOTA
(HINO)
- MAZDA**
- ISUZU
- HONDA
- MITSUBISHI
- SUBARU
- SUZUKI
- DAIHATSU
- LEXUS
- INFINITI
- HYUNDAI
- KIA

Model 車種形式	Year 年式	Front フロント		Rear リア		Parking パーキング
		Pad パッド	Shoe シュー	Pad パッド	Shoe シュー	Shoe シュー
CRONOS						
1800 GE8P	91. 9 ~ 94. 7	HN-239		HN-238		
2000 GEEP, GEFP	91. 9 ~ 96. 4	HN-239		HN-238		
GESR	91.11 ~ 96. 4	HN-239		HN-203		
2500 GE5P	92. 4 ~ 96. 4	HN-239		HN-238		
CLEF						
2000 GEEPA	92. 4 ~ 94. 7	HN-239		HN-238		
GESRA	92. 4 ~ 94. 7	HN-239		HN-203		
2500 GE5PA	92. 4 ~ 94. 7	HN-239		HN-238		
SCRUM						
660 DG41B, DG41T, DG41V	89. 5 ~ 90. 2	HN-408	FN-9932		FN-9919	
DH41T, DH41V	89. 5 ~ 90. 2	HN-408	FN-9932		FN-9919	
DG51B	90. 2 ~ 91. 9		FN-9932		FN-9919	
DG51T	90. 2 ~ 91. 9	HN-408	FN-9932		FN-9919	
DG51V GA FRONT DRUM	90. 2 ~ 91. 9		FN-9932		FN-9919	
PL FRONT DISC	90. 2 ~ 91. 9	HN-408			FN-9923	
DH51T	90. 2 ~ 91. 9	HN-408			FN-9919	
DH51V	90. 2 ~ 91. 9				FN-9923	
DJ51B, DK51B	91. 9 ~ 98.10	HN-408			FN-9943	
DJ51T, DK51T AT	91. 9 ~ 98.10	HN-408			FN-9943	
MT No. ~390000	91. 9 ~ 98.10	HN-408			FN-9919	
MT No. 390001~	91. 9 ~ 98.10	HN-408			FN-9951	
DL51V, DM51V No. ~770000	91. 9 ~ 98.10	HN-408			FN-9943	
No. 770001~	91. 9 ~ 98.10	HN-408			FN-9952	
DG52T, DH52T TRUCK	99. 1 ~ 01. 9	HN-439			FN-9951	
DUMP TRUCK	99. 1 ~ 01. 9	HN-439			FN-5524	
DG52V, DH52V	99. 1 ~ 01. 9	HN-439			FN-9962	
DG52W	99.12 ~ 01. 9	HN-439			FN-9962	
DG62T TRUCK	01. 9 ~ 02. 5	HN-439			FN-9951	
DUMP TRUCK	01. 9 ~ 02. 5	HN-439			FN-5524	
DG62V, DG62W	01. 9 ~ 05. 9	HN-439			FN-9962	
DG63T TRUCK No. ~380000	02. 5 ~ 05. 9	HN-426			FN-9966	
No. 380001~	05. 9 ~ 13. 9	HN-566			FN-9966	
DUMP TRUCK No. ~380000	02. 5 ~ 05. 9	HN-426			FN-5524	
No. 380001~	05. 9 ~ 13. 9	HN-566			FN-5524	
DG64V, DG64W	05. 9 ~ 15. 3	HN-566			FN-9973	
DG17V, W	15. 3 ~	HN-566				
SPIANO						
660 HF21S TURBO No. ~910000	02. 2 ~ 04.10	HN-426			FN-9959	
No. 910001~	02. 2 ~ 04.10	HN-426			FN-9967	
2WD No. ~320000	02. 2 ~ 04.10	HN-426			FN-9959	
No. 320001~	02. 2 ~ 04.10	HN-426			FN-9967	
4WD No. ~110000	02. 2 ~ 04.10	HN-426			FN-9959	
No. 110001~	02. 2 ~ 04.10	HN-426			FN-9967	

MAZDA - 7

Model 車種形式			Year 年式	Front フロント		Rear リア		Parking パーキング
				Pad パッド	Shoe シュー	Pad パッド	Shoe シュー	Shoe シュー
SPIANO								
660	HF21S	W/ TURBO	04.10 ~	HN-426			FN-9967	
		W/O TURBO	04.10 ~ 05. 2	HN-426			FN-9967	
		W/O TURBO	05. 2 ~	HN-566			FN-9967	
SPECTRON								
2000	SS28RF	4WD	83. 9 ~ 97.10	HN-211			FN-3348	
	SS88WF		No. ~151352	83. 9 ~ 97.10	HN-211		FN-3348	
			No. 151353~	83. 9 ~ 97.10	HN-211		FN-3348	
	SSE8RF		86.11 ~ 93. 8	HN-211			FN-3348	
	SSE8WF		86.11 ~ 95. 9	HN-211			FN-3348	
	SSF8RF		88.12 ~ 97.10	HN-211			FN-3348	
	SSF8WF		83. 9 ~ 97.10	HN-211			FN-3348	
	SE88TF		95. 8 ~ 99. 5	HN-211			FN-3351	
	SE28TF		93. 9 ~ 99. 5	HN-211			FN-3351	
SENTIA								
2500	HD5S, HD5P		91. 3 ~ 96. 1	HN-294		HN-290		
3000	HDES, HDEP		91. 3 ~ 96. 1	HN-294		HN-290		
	HEEA, HEEP		95.10 ~ 00. 9	HN-294		HN-290		
TITAN								
2000	SYE4T	1t	SINGLE TYRE	00.10 ~ 04. 8	HN-376		FN-3406	
			SINGLE TYRE	04. 8 ~	HN-376			
			DOUBLE TYRES	00.10 ~ 04. 8	HN-376		FN-3407	
			DOUBLE TYRES	04. 8 ~	HN-376		FN-3426	
		1.35t	SINGLE TYRE	00.10 ~ 04. 8			FN-3406	
			DOUBLE TYRES	00.10 ~ 04. 8			FN-3407	
	SYF4L			04. 8 ~	HN-376			
	SYF4T	1t	DOUBLE TYRES	04. 8 ~	HN-376		FN-3426	
		1.35t	SINGLE TYRE	04. 8 ~				
	SYE6T	1.5t	SINGLE TYRE	00.10 ~ 04. 8	HN-376		FN-3406	
		1.5t	SINGLE TYRE	04. 8 ~	HN-376			
		1.25t	DOUBLE TYRES	00.10 ~ 04. 8	HN-376		FN-3407	
		1.25t	DOUBLE TYRES	04. 8 ~	HN-376		FN-3426	
	SYF6L		SINGLE TYRE	04. 8 ~	HN-376			
			DOUBLE TYRES	04. 8 ~	HN-376		FN-3426	
	SYF6T		SINGLE TYRE	04. 8 ~	HN-376			
			DOUBLE TYRES	04. 8 ~	HN-376		FN-3426	
	WEF4T, WEF4C		SINGLE TYRE	84. 1 ~ 87. 2		FN-3335	FN-3334	FN-3340
			DOUBLE TYRES	84. 1 ~ 87. 2		FN-3336	FN-3337	FN-3340
	WEL4T, WEL4H	HIGH FLOOR		84. 1 ~ 87. 2		FN-3336	FN-3337	FN-3340
		WIDE LOW		84. 1 ~ 87. 2		FN-3336	FN-3334	FN-3340
		WIDE LOW/2t		84. 1 ~ 89. 5		FN-3336	FN-3334	FN-8802
		HIGH FLOOR		84. 1 ~ 89. 5		FN-3336	FN-3337	FN-8802
		FULLWIDE LOW		84. 1 ~ 89. 5		FN-3370	FN-3371	FN-3340
		3t WIDE LOW, TURBO		84. 1 ~ 89. 5		FN-3361	FN-3334	FN-8802
	WEL4M			87. 2 ~ 89. 5		FN-3336	FN-3337	FN-8802
	WE5AT	WIDE LOW/1.5t		87. 2 ~ 89. 5		FN-3333	FN-3334	FN-3340

NISSAN

TOYOTA
(HINO)

MAZDA

ISUZU

HONDA

MITSUBISHI

SUBARU

SUZUKI

DAIHATSU

LEXUS

INFINITY

HYUNDAI

KIA

MAZDA - 8

- NISSAN
- TOYOTA (HINO)
- MAZDA**
- ISUZU
- HONDA
- MITSUBISHI
- SUBARU
- SUZUKI
- DAIHATSU
- LEXUS
- INFINITI
- HYUNDAI
- KIA

Model 車種形式	Year 年式	Front フロント		Rear リア		Parking パーキング
		Pad パッド	Shoe シュー	Pad パッド	Shoe シュー	Shoe シュー
TITAN						
2t	SINGLE TYRE					
2000 WE5AT	2t					
	FULLWIDE LOW					
	DOUBLE CABIN					
WEFAT	WIDE LOW					
	HIGH FLOOR					
WELAC, WELAK	HIGH FLOOR					
WELAN, WELAT	HIGH FLOOR					
	WIDE LOW					
WELAN, WELAT	DUMPTRUCK /3t					
	DUMPTRUCK /4t					
	DUMPTRUCK TURBO					
2500 WG5AT						
	FULLWIDE LOW					
SY54T	1t					
	SINGLE TYRE					
	DOUBLE TYRES					
	1.35t					
	SINGLE TYRE					
	DOUBLE TYRES					
	LONG BODY/1.35t					
	LONG BODY/1.5t					
SY54L	1.25t					
	SINGLE TYRE					
	DOUBLE TYRES					
SY56T	LONG BODY/1.25t					
	SINGLE TYRE					
	DOUBLE TYRES					
SY56L	LONG BODY/1t					
	LONG BODY/1.5t					
3000 WGFAD						
WGFAT	FRONT DRUM					
	FRONT DRUM HIGH-FLOOR					
	DOUBLE TYRES					
	WIDE LOW/1.5t					
	FRONT DRUM					
	WIDE LOW/2t					
	FRONT DRUM					
	FULLWIDE LOW					
	FRONT DRUM					
WGSAT	FRONT DISK					
	WIDE LOW/1.5t					
	WIDE LOW/1.5t					
	FULLWIDE LOW					
	FULLWIDE LOW					
	1.5t					
	HIGH-FLOOR					
	1.5t					
	HIGH-FLOOR					
	WIDE LOW/2t					
	WIDE LOW/2t					
	FULLWIDE LOW					
	FULLWIDE LOW					
	2t					
	HIGH-FLOOR					
	2t					
	HIGH-FLOOR					
	2t					
	HIGH-FLOOR					
	DOUBLE TYRES					
	2t					
	HIGH-FLOOR					
	DOUBLE TYRES					

MAZDA - 9

Model 車種形式	Year 年式	Front フロント		Rear リア		Parking パーキング
		Pad パッド	Shoe シュー	Pad パッド	Shoe シュー	Shoe シュー
TITAN						
WHS5T 1.5t	00. 5 ~	HN-464				FN-3408 FN-3384
LLR85 INDEPENDENT SUS/2t HIGH-FLOOR DOUBLE TYRES	07. 2 ~	HN-543				FN-4461 FN-4443
2t/FULLFLAT-LOW DOUBLE TYRES	07. 2 ~	HN-464				FN-4451 FN-4443
LMR85 INDEPENDENT SUS/3t HIGH-FLOOR DOUBLE TYRES	07. 2 ~	HN-464				FN-4459 FN-4443
GARBAGE TRUCK/2t HIGH-FLOOR DOUBLE TYRES	07. 2 ~	HN-464				FN-4459 FN-4443
EXCL. GARBAGE TRUCK/2t HIGH-FLOOR DOUBLE TYRES	07. 2 ~	HN-543				FN-4451 FN-4443
LLS85, LMS85 3t/FULLWIDE LOW DOUBLE TYRES	07. 2 ~	HN-543				FN-4451 FN-4443
3100 LHR69	04. 7 ~ 06.12					FN-4404
LHS69	04.10 ~ 06.12	HN-384				FN-4465 FN-4443
3500 WGL4H	89. 4 ~ 95. 5		FN-3361			FN-3334 FN-3384
TURBO HIGH-FLOOR	89. 4 ~ 95. 5		FN-3419			FN-3420 FN-3384
WIDE LOW, TURBO	89. 4 ~ 95. 5		FN-3419			FN-3362 FN-3384
WGL4M	89. 4 ~ 95. 5		FN-3336			FN-3337 FN-3384
WGL4T 2.75t HIGH-FLOOR	89. 4 ~ 95. 5		FN-3336			FN-3337 FN-3384
TURBO/ 2.75t	89. 4 ~ 95. 5		FN-3361			FN-3362 FN-3384
WIDE LOW	89. 4 ~ 95. 5		FN-3336			FN-3334 FN-3384
WGLAM	89. 4 ~ 95. 5		FN-3336			FN-3337 FN-3384
WGLAN	89. 4 ~ 95. 5		FN-3336			FN-3337 FN-3384
WGLAD HIGH-FLOOR	89. 4 ~ 95. 5		FN-3336			FN-3337 FN-3384
WIDE LOW	89. 4 ~ 95. 5		FN-3336			FN-3334 FN-3384
WGLAF HIGH-FLOOR	89. 4 ~ 95. 5		FN-3361			FN-3362 FN-3384
WIDE LOW	89. 4 ~ 95. 5		FN-3361			FN-3334 FN-3384
WGLAK	90. 7 ~ 95. 5		FN-3361			FN-3362 FN-3384
WGLAT WIDE LOW DOUBLE TYRES	89. 4 ~ 95. 5		FN-3336			FN-3334 FN-3384
2t LOW-FLOOR DOUBLE TYRES	89. 4 ~ 95. 5		FN-3361			FN-3362 FN-3384
2t HIGH-FLOOR DOUBLE TYRES	89. 4 ~ 95. 5		FN-3336			FN-3337 FN-3384
FRONT DISK	89. 4 ~ 95. 5	HN-392				FN-3371 FN-3384
4000 WGT1D	89. 4 ~ 95. 5		FN-3419			FN-3420 FN-3384
WGT4H 3.5t HIGH-FLOOR	89. 4 ~ 95. 5		FN-3361			FN-3362 FN-3384
4t HIGH-FLOOR	89. 4 ~ 95. 5		FN-3419			FN-3420 FN-3384
WIDE LOW	89. 4 ~ 95. 5		FN-3361			FN-3334 FN-3384
WGT4T 2t HIGH-FLOOR	89. 4 ~ 95. 5		FN-3336			FN-3337 FN-3384
2.75t HIGH-FLOOR	89. 4 ~ 95. 5		FN-3361			FN-3362 FN-3384
WIDE LOW	89. 4 ~ 95. 5		FN-3336			FN-3334 FN-3384
WGTAD	89. 4 ~ 95. 5		FN-3336			FN-3337 FN-3384
WGTAT	89. 4 ~ 95. 5		FN-3336			FN-3337 FN-3384
WGTAE	89. 4 ~ 95. 5		FN-3361			FN-3362 FN-3384
WGTAH	89. 4 ~ 95. 5		FN-3361			FN-3362 FN-3384
WGEAT WIDE LOW/2t	95. 5 ~ 99. 4	HN-392	FN-3390			FN-3334 FN-3384
WIDE LOW/2t	99. 4 ~ 00. 5	HN-464	FN-3408			FN-3408 FN-3384
FULLWIDE LOW	95. 5 ~ 99. 4		FN-3390			FN-3389 FN-3384
FULLWIDE LOW	99. 4 ~ 00. 5	HN-464	FN-3408			FN-3408 FN-3384
HIGH-FLOOR	95. 5 ~ 99. 4	HN-392	FN-3390			FN-3337 FN-3384
HIGH-FLOOR	99. 4 ~ 00. 5	HN-464	FN-3408			FN-3409 FN-3384
HIGH-FLOOR	95. 5 ~ 99. 4		FN-3336			FN-3337 FN-3384
HIGH-FLOOR	99. 4 ~ 00. 5	HN-464				FN-3384

- NISSAN
- TOYOTA (HINO)
- MAZDA
- ISUZU
- HONDA
- MITSUBISHI
- SUBARU
- SUZUKI
- DAIHATSU
- LEXUS
- INFINITY
- HYUNDAI
- KIA

MAZDA - 10

- NISSAN
- TOYOTA
(HINO)
- MAZDA**
- ISUZU
- HONDA
- MITSUBISHI
- SUBARU
- SUZUKI
- DAIHATSU
- LEXUS
- INFINITI
- HYUNDAI
- KIA

Model 車種形式	Year 年式	Front フロント		Rear リア		Parking パーキング
		Pad パッド	Shoe シュー	Pad パッド	Shoe シュー	Shoe シュー
TITAN						
	DISEL/3t					
4000 WGEAD	WIDE LOW			FN-3336		FN-3337 FN-3384
	WIDE LOW			FN-3390		FN-3334 FN-3384
	WIDE LOW			FN-3408		FN-3409 FN-3384
	FULLWIDE LOW			FN-3390		FN-3389 FN-3384
	FULLWIDE LOW			FN-3408		FN-3408 FN-3384
		HIGH-FLOOR		FN-3336		FN-3337 FN-3384
		HIGH-FLOOR		FN-3408		FN-3408 FN-3384
WGEAH		HIGH-FLOOR		FN-3336		FN-3337 FN-3384
				FN-3408		FN-3408 FN-3384
WGFAK	WIDE LOW DUMP TRUCK			FN-3336		FN-3334 FN-3384
				FN-3408		FN-3408 FN-3384
WGE1T				FN-3336		FN-3334 FN-3384
				FN-3408		FN-3408 FN-3384
WGE4T	WIDE LOW			FN-3390		FN-3334 FN-3384
	WIDE LOW			HN-464		FN-3408 FN-3384
		HIGH-FLOOR		FN-3390		FN-3389 FN-3384
		HIGH-FLOOR		HN-464		FN-3408 FN-3384
4100 WH65H				HN-464		FN-3408 FN-3384
				FN-3408		FN-3408 FN-3384
WHF3F, 3G				HN-464		FN-3408 FN-3384
				FN-3408		FN-3408 FN-3384
WHF5D				HN-464		FN-3408 FN-3384
				FN-3408		FN-3408 FN-3384
WHF5G				HN-464		FN-3408 FN-3384
				FN-3408		FN-3408 FN-3384
WHF5T				HN-464		FN-3408 FN-3384
				FN-3408		FN-3408 FN-3384
4300 WG3AT	WIDE LOW W/O ABS			FN-3390		FN-3334 FN-3384
	WIDE LOW W/O ABS			HN-464		FN-3408 FN-3384
	FULLWIDE LOW W/O ABS	HIGH-FLOOR		FN-3390		FN-3389 FN-3384
	FULLWIDE LOW W/O ABS	HIGH-FLOOR		HN-464		FN-3408 FN-3384
	W/ ABS			FN-3336		FN-3337 FN-3384
	W/ ABS			HN-464		FN-3405 FN-3384
WG3AM		HIGH-FLOOR		FN-3336		FN-3337 FN-3384
WGJ4T		HIGH-FLOOR		FN-3336		FN-3337 FN-3384
		HIGH-FLOOR		FN-3408		FN-3408 FN-3384
WG3AD	WIDE LOW			FN-3390		FN-3334 FN-3384
	WIDE LOW			FN-3408		FN-3409 FN-3384
		HIGH-FLOOR		FN-3336		FN-3337 FN-3384
		HIGH-FLOOR		FN-3408		FN-3408 FN-3384
WG3AN		HIGH-FLOOR		FN-3336		FN-3337 FN-3384
WG3AH		HIGH-FLOOR		FN-3336		FN-3337 FN-3384
		HIGH-FLOOR		FN-3408		FN-3408 FN-3384
WG31T	WIDE LOW			FN-3336		FN-3334 FN-3384
	WIDE LOW			FN-3408		FN-3409 FN-3384
WG34T	WIDE LOW			FN-3390		FN-3334 FN-3384
	WIDE LOW			HN-464		FN-3408 FN-3384
	FULLWIDE LOW			FN-3390		FN-3389 FN-3384
	FULLWIDE LOW			HN-464		FN-3408 FN-3384
		HIGH-FLOOR		FN-3390		FN-3389 FN-3384
		HIGH-FLOOR		HN-464		FN-3408 FN-3384
WH33F				HN-464		FN-3409 FN-3384

MAZDA - 11

Model 車種形式			Year 年式	Front フロント		Rear リア		Parking パーキング
				Pad パッド	Shoe シュー	Pad パッド	Shoe シュー	Shoe シュー
TITAN								
4300	WH33G		00. 5 ~ 02.11	HN-464			FN-3409	FN-3384
	WH35D		00. 4 ~ 02.11	HN-464	FN-3408		FN-3408	FN-3384
	WH35H	HIGH-FLOOR	00. 4 ~ 02.11	HN-464	FN-3408		FN-3408	FN-3384
	WH35T		00. 5 ~ 02.11	HN-464	FN-3408		FN-3408	FN-3384
	WH38H	FULLWIDE LOW	00. 4 ~ 02.11	HN-464			FN-3408	FN-3384
	WH3HD, HH	FULLWIDE LOW	00. 6 ~ 02.11	HN-464	FN-3408		FN-3408	FN-3384
	LKR81	2t HIGH-FLOOR DOUBLE TYRES	04. 7 ~	HN-464	FN-4459		FN-4459	FN-4443
4600	WGM4T	WIDE LOW W/O ABS	91.12 ~ 95. 5		FN-3336		FN-3334	FN-3384
	WGM4T	W/ ABS	91.12 ~ 95. 5		FN-3336		FN-3371	FN-3384
		FULLWIDE LOW	91.12 ~ 95. 5		FN-3336		FN-3337	FN-3384
		2t HIGH-FLOOR	91.12 ~ 95. 5		FN-3336		FN-3337	FN-3384
		2.75t HIGH-FLOOR	91.12 ~ 95. 5		FN-3361		FN-3362	FN-3384
	WGM4S	2t HIGH-FLOOR	91.12 ~ 95. 5		FN-3336		FN-3337	FN-3384
	WGM4H	WIDE LOW	91.12 ~ 95. 5		FN-3361		FN-3334	FN-3384
		FULLWIDE LOW	91.12 ~ 95. 5		FN-3361		FN-3362	FN-3384
		HIGH-FLOOR	91.12 ~ 95. 5		FN-3419		FN-3420	FN-3384
	WGM1D	DUMP TRUCK	92. 1 ~ 95. 5		FN-3419		FN-3420	FN-3384
	WGM7T		91.12 ~ 95. 5		FN-3336		FN-3337	FN-3384
	WGM7H		91.12 ~ 95. 5		FN-3419		FN-3420	FN-3384
	WGMAD	DUMP TRUCK	92. 1 ~ 95. 5		FN-3336		FN-3337	FN-3384
	WGMAF		93. 6 ~ 95. 5		FN-3361		FN-3362	FN-3384
	WG6AT		95. 5 ~ 99. 4		FN-3336		FN-3337	FN-3384
			99. 4 ~ 00. 5	HN-464	FN-3408		FN-3408	FN-3384
	WG6AD	WIDE LOW	95. 5 ~ 99. 4		FN-3390		FN-3334	FN-3384
		WIDE LOW	99. 4 ~ 00. 5		FN-3408		FN-3409	FN-3384
		HIGH-FLOOR	95. 5 ~ 99. 4		FN-3336		FN-3337	FN-3384
		HIGH-FLOOR	99. 4 ~ 00. 5		FN-3408		FN-3408	FN-3384
	WG6AK	3t HIGH-FLOOR	95. 5 ~ 99. 4		FN-3336		FN-3337	FN-3384
			99. 4 ~ 00. 5		FN-3408		FN-3408	FN-3384
	WG6AF	3t HIGH-FLOOR	95. 5 ~ 99. 4		FN-3336		FN-3337	FN-3384
			99. 4 ~ 00. 5		FN-3408		FN-3408	FN-3384
	WG61T	3t HIGH-FLOOR	95. 5 ~ 99. 4		FN-3336		FN-3337	FN-3384
			99. 4 ~ 00. 5		FN-3408		FN-3408	FN-3384
		3.5t HIGH-FLOOR	95. 5 ~ 99. 4		FN-3361		FN-3362	FN-3384
			99. 4 ~ 00. 5		FN-3408		FN-3408	FN-3384
	WG61D	3t DUMP TRUCK HIGH-FLOOR	95. 5 ~ 99. 4		FN-3336		FN-3337	FN-3384
			99. 4 ~ 00. 5		FN-3408		FN-3408	FN-3384
	WG61H	4t HIGH-FLOOR	95. 5 ~ 99. 4		FN-3419		FN-3420	FN-3384
			99. 4 ~ 00. 5		FN-3419		FN-3420	FN-3384
	WG61K	4t DUMP TRUCK HIGH-FLOOR	95. 5 ~ 99. 4		FN-3419		FN-3420	FN-3384
			99. 4 ~ 00. 5		FN-3419		FN-3420	FN-3384
	WG64T	WIDE LOW	95. 5 ~ 99. 4		FN-3390		FN-3334	FN-3384
			99. 4 ~ 00. 5	HN-464	FN-3408		FN-3409	FN-3384
		FULLWIDE LOW	95. 5 ~ 99. 4		FN-3390		FN-3389	FN-3384
		HIGH-FLOOR	99. 4 ~ 00. 5	HN-464	FN-3408		FN-3408	FN-3384
			95. 5 ~ 99. 4		FN-3390		FN-3389	FN-3384
			99. 4 ~ 00. 5	HN-464	FN-3408		FN-3408	FN-3384
	WG64H	3t	95. 5 ~ 99. 4		FN-3336		FN-3337	FN-3384

- NISSAN
- TOYOTA (HINO)
- MAZDA
- ISUZU
- HONDA
- MITSUBISHI
- SUBARU
- SUZUKI
- DAIHATSU
- LEXUS
- INFINITY
- HYUNDAI
- KIA

MAZDA - 12

- NISSAN
- TOYOTA
(HINO)
- MAZDA**
- ISUZU
- HONDA
- MITSUBISHI
- SUBARU
- SUZUKI
- DAIHATSU
- LEXUS
- INFINITI
- HYUNDAI
- KIA

Model 車種形式	Year 年式	Front フロント		Rear リア		Parking パーキング
		Pad パッド	Shoe シュー	Pad パッド	Shoe シュー	Shoe シュー
TITAN						
4600 WG64H	3.5t, 4.25t		FN-3408		FN-3408	FN-3384
			FN-3361		FN-3362	FN-3384
WGZ4T	2.95t HIGH-FLOOR		FN-3408		FN-3408	FN-3384
			FN-3336		FN-3337	FN-3384
WG67T	FULLWIDE LOW		FN-3408		FN-3408	FN-3384
	2t HIGH-FLOOR DOUBLE TYRES		FN-3336		FN-3337	FN-3384
	WIDE LOW		FN-3408		FN-3408	FN-3384
WG67H	3.5t, 4t HIGH-FLOOR		FN-3419		FN-3420	FN-3384
WG67H	3.5t, 4t HIGH-FLOOR		FN-3419		FN-3420	FN-3384
WH63F	FULLWIDE LOW HIGH-FLOOR	HN-464	FN-3408		FN-3408	FN-3384
WH63G	FULLWIDE LOW HIGH-FLOOR	HN-464	FN-3408		FN-3408	FN-3384
WH63H	FULLWIDE LOW HIGH-FLOOR	HN-464	FN-3408		FN-3408	FN-3384
WH65D		HN-464	FN-3408		FN-3408	FN-3384
WH65G		HN-464	FN-3408		FN-3408	FN-3384
WH65T	FULLWIDE LOW HIGH-FLOOR	HN-464	FN-3408		FN-3408	FN-3384
WH68G	FULLWIDE LOW	HN-464	FN-3408		FN-3408	FN-3384
WH68H	FULLWIDE LOW HIGH-FLOOR	HN-464	FN-3408		FN-3408	FN-3384
WH68K		HN-464	FN-3408		FN-3408	FN-3384
WH69G	FULLWIDE LOW	HN-464	FN-3408		FN-3408	FN-3384
WH69H						FN-3384
WH6HD	FULLWIDE LOW HIGH-FLOOR	HN-464	FN-3408		FN-3408	FN-3384
WH6HH	FULLWIDE LOW HIGH-FLOOR	HN-464	FN-3408		FN-3408	FN-3384
LKR81	2t HIGH-FLOOR DOUBLE TYRES	HN-464	※		※	FN-4443
	2t HIGH-FLOOR SINGLE TYRE	HN-543	※		※	FN-4443
※ FRONT DRUM:FN-4459, REAR DRUM:FN-4451orFN-4461						
LPR81	2t HIGH-FLOOR DOUBLE TYRES	HN-464	※		※	FN-4443
	3t/FULLFLAT-LOW HIGH-FLOOR DOUBLE TYRES	HN-491	※		※	FN-4443
※ FRONT DRUM:FN-4459, REAR DRUM:FN-4459orFN-4451orFN-4461						
LPR82	2t HIGH-FLOOR DOUBLE TYRES	HN-464	FN-4459		FN-4459	FN-4443
LKR82	2t HIGH-FLOOR DOUBLE TYRES	HN-464	FN-4459		FN-4459	FN-4443
4800 LKR81	2t, 3t HIGH-FLOOR DOUBLE TYRES	HN-464	※		※	FN-4443
	2t/FULLFLAT-LOW HIGH-FLOOR SINGLE TYRE	HN-543	※		※	FN-4443
※ FRONT DRUM:FN-4459, REAR DRUM:FN-4451orFN-4461						
LPR81	2t, 2.75t HIGH-FLOOR DOUBLE TYRES	HN-464	※		※	FN-4443
	4t HIGH-FLOOR DOUBLE TYRES	HN-491	※		※	FN-4443
※ FRONT DRUM:FN-4459, REAR DRUM:FN-4459orFN-4451orFN-4461						
LKS81		HN-384	FN-4451		※	FN-4443
※ REAR DRUM:FN-4451orFN-4459						
LPS81	2t/FULLFLAT-LOW DOUBLE TYRES	HN-464	※		※	FN-4443
	3.5t/FULLFLAT-LOW DOUBLE TYRES	HN-491	※		※	FN-4443
※ FRONT DRUM:FN-4451, REAR DRUM:FN-4451orFN-4459						
DEMIO						
1300 DW3W	W/O ABS No. ~500000	96.7 ~ 00.4	HN-232			FN-3387
	W/ ABS No. ~500000	96.7 ~ 00.4	HN-232			FN-3388
	No. 500001 ~	99.11 ~ 02.7	HN-232			FN-3388
DY3W		02.6 ~ 07.7	HN-495			FN-3421

MAZDA - 13

Model 車種形式	Year 年式	Front フロント		Rear リア		Parking パーキング
		Pad パッド	Shoe シュー	Pad パッド	Shoe シュー	Shoe シュー
DEMIO						
1300 DY3R 4WD	03.11 ~ 07. 7	HN-495				FN-3421
DE3AS, DE3FS	07. 7 ~ 14. 8	HN-544				FN-3431
DEJFS	11. 7 ~	HN-544				
1500 DW5W W/O ABS No. ~300000	96. 7 ~ 00. 4	HN-232				FN-3387
W/ ABS No. ~300000	96. 7 ~ 00. 4	HN-232				FN-3388
No. 300001~	99.11 ~ 02. 7	HN-232				FN-3388
DY5W	02. 6 ~ 07. 7	HN-495				FN-3421
DY5R 4WD	03.11 ~ 07. 7	HN-495				FN-3421
DE5FS W/O SIDESPOILER	07. 7 ~ 14. 8	HN-544				FN-3434
W/ SIDESPOILER, SPORT	07. 7 ~ 14. 8	HN-562				FN-3431
TELSTAR						
GC6PF, GC8PF	82. 9 ~ 87. 4					FN-3347
GCEPF, GC8PF	82. 9 ~ 87. 4					FN-3347
GD8PE	82. 9 ~ 87. 4	HN-239		HN-195		FN-3386
CG2RF, GESRF	82. 9 ~ 87. 4	HN-239		HN-195		FN-3386
1600 GD6PF	87. 4 ~ 89. 5	HN-194				FN-3373
1800 GD8AF	87. 4 ~ 91.10	HN-194		HN-195		
GD8PF	89. 5 ~ 91.10	HN-194		HN-195		FN-3373
EG1, DOHC	89. 5 ~ 91.10	HN-194		HN-195		FN-3372
GD8RF 4WD	89. 5 ~ 91.10	HN-194		HN-203		
GE8PF	91.10 ~ 94. 7	HN-239		HN-238		
GV8WF	92. 8 ~ 97.10	HN-194		HN-195		
CG2PPF W/O ABS	94. 7 ~ 97. 6	HN-239		HN-238		FN-3386
W/ ABS	94. 7 ~ 97. 6	HN-239		HN-238		
GF8PF	97. 6 ~ 99. 8	HN-239				FN-3386
GW8WF No. ~100487	97.10 ~ 99. 8	HN-239				FN-3391
No. 100488~	97.10 ~ 99. 8	HN-239				FN-3399
2000 GDEAF, GDEPF	87. 4 ~ 91.10	HN-194		HN-195		
GDERF	87. 6 ~ 91.10	HN-194		HN-203		
GDEPF	87. 4 ~ 91.10	HN-194		HN-195		
GEEPF	91.10 ~ 96. 1	HN-239		HN-238		
GEFPF	92. 4 ~ 95.10	HN-239		HN-238		
GVERF GT, 20iX	90. 8 ~ 97.10	HN-194		HN-203		
FX, 20iXCA	94.10 ~ 97.10	HN-331		HN-203		
GVFRF	92. 8 ~ 97.10	HN-331		HN-203		
GVEWF	96. 6 ~ 97.10	HN-194		HN-195		
GVFWF	90. 8 ~ 97.10	HN-194		HN-195		
CG2SPF	94. 7 ~ 97. 6	HN-239		HN-238		
CG2SRF	94. 7 ~ 97. 6	HN-239		HN-203		
GFEPF	97. 6 ~ 99. 8	HN-239		HN-238		
GFERF	97. 6 ~ 99. 8	HN-239		HN-203		
GFFPF	98. 6 ~ 99. 8	HN-239				FN-3386
GVEWF	97.10 ~ 99. 8	HN-239		HN-203		
GWERF	97.10 ~ 99. 8	HN-418		HN-203		
GWFWF	98. 7 ~ 99. 8	HN-418		HN-203		

- NISSAN
- TOYOTA (HINO)
- MAZDA**
- ISUZU
- HONDA
- MITSUBISHI
- SUBARU
- SUZUKI
- DAIHATSU
- LEXUS
- INFINITY
- HYUNDAI
- KIA

MAZDA - 14

- NISSAN
- TOYOTA
(HINO)
- MAZDA**
- ISUZU
- HONDA
- MITSUBISHI
- SUBARU
- SUZUKI
- DAIHATSU
- LEXUS
- INFINITI
- HYUNDAI
- KIA

Model 車種形式	Year 年式	Front フロント		Rear リア		Parking パーキング
		Pad パッド	Shoe シュー	Pad パッド	Shoe シュー	Shoe シュー
TELSTAR						
2500 GE5PF	92. 4 ~ 96. 1	HN-239		HN-238		
GW5RF	97.10 ~ 99. 8	HN-418		HN-203		
TRIBUTE						
2000 EPEW	00.11 ~ 03.12				FN-3382	
2300 EP3W, EP3WF	03.12 ~ 05.10				FN-3382	
3000 EPFW	00.11 ~ 05.10				FN-3382	
PARKWAY						
3500 WVLSF, WVF4B	81.10 ~		FN-3336		FN-3337	FN-3340
WVL4B	84. 5 ~		FN-3336		FN-3337	FN-3340
BIANTE						
2000 CCEFW, CCEAW	08. 5 ~ 12. 7	HN-507		HN-578		
CCFFW	13. 5 ~	HN-507		HN-578		
2300 CC3FW	08. 5 ~ 12. 7	HN-507		HN-578		
FAMILIA						
1200 BVAY12	07. 1 ~	HN-452			FN-1264	
1300 FA4TV, FA4UV	FRONT DRUM			FN-3307		FN-3307
	FRONT DISC No. ~250000	78. 5 ~ 83.10	HN-025			FN-3307
	FRONT DISC No. 250001~	83.10 ~ 85.12	HN-025			FN-3343
BF3P, BFTP		84.11 ~ 89. 2	HN-070	HN-353		FN-3356
BF3V		85.11 ~ 94. 8	HN-138			FN-3358
BG3P		89. 2 ~ 91. 1	HN-232			FN-3373
	No. 300930~	90. 1 ~ 96. 1	HN-232			FN-3385
BG3S	No. ~301552	90. 1 ~ 96. 1	HN-232			FN-3373
	No. 301553~	90. 1 ~ 96. 1	HN-232			FN-3385
BW3W		89.10 ~ 94. 8	HN-138			FN-3356
BHA3P, BHA3S		96. 8 ~ 99. 5	HN-232			FN-3385
BVY10	VAN No. ~513000	94. 8 ~ 97. 5	HN-375			FN-1185
	No. 513001~	97. 5 ~ 99. 4	HN-225			FN-1185
BJ3P		98. 4 ~ 02. 8	HN-425			FN-3394
BVY11	VAN W/O ABS	99. 5 ~ 02. 8	HN-435			FN-1170
	W/ ABS	99. 5 ~	HN-435			FN-1198
1500 BF5P		84.11 ~ 89. 2	HN-138		HN-353	FN-3356
BF5R		84.11 ~ 89. 2			HN-353	FN-3356
BF5S, BFMP, BFMR		84.11 ~ 89. 2	HN-138		HN-353	FN-3356
BFMS, BFSP, BFSR		84.11 ~ 89. 2	HN-138		HN-353	FN-3356
BF5V		85.11 ~ 94. 8	HN-138			FN-3358
BW5W		89.10 ~ 94. 8	HN-138			FN-3356
BG5P		89. 2 ~ 90. 1	HN-232			FN-3373
		90. 1 ~ 94. 4	HN-232			FN-3385
BG5S		89. 2 ~ 90. 1	HN-232			FN-3373

MAZDA - 15

Model 車種形式	Year 年式	Front フロント		Rear リア		Parking パーキング
		Pad パッド	Shoe シュー	Pad パッド	Shoe シュー	Shoe シュー
FAMILIA						
1500 BG5S	90. 1 ~ 94. 4	HN-232				FN-3385
BHALP	94. 3 ~ 99. 5	HN-232		HN-365		FN-3385
BHALS	94. 5 ~ 99. 5	HN-232		HN-365		FN-3385
BHA5P	94. 5 ~ 96.10	HN-230		HN-365		FN-3385
BHA5S	94. 5 ~ 96.10	HN-230		HN-365		FN-3385
BV FY10	VAN W/O ABS No. ~513000	94. 8 ~ 97. 5	HN-375			FN-1185
	W/O ABS No. 513001~	97. 5 ~ 99. 4	HN-225			FN-1185
	W/ ABS	94. 8 ~ 99. 4	HN-225			FN-1198
BMV FY10		94. 8 ~ 99. 4	HN-375			FN-1185
BW FY10	STATION WAGON W/O ABS No. ~508000	94. 8 ~ 96. 5	HN-375			FN-1185
	W/O ABS No. 508001~	96. 5 ~ 99. 4	HN-356			FN-1185
	W/ ABS No. ~508000	94. 8 ~ 96. 5	HN-225			FN-1198
BW FY10	W/ ABS No. 508001~	96. 5 ~ 99. 4	HN-356			FN-1198
BV FNY10	VAN	94. 8 ~ 99. 4	HN-225			FN-1170
BW FNY10	STATION WAGON W/O ABS No. ~508000	94. 8 ~ 96. 5	HN-225			FN-1170
	W/O ABS No. 508001~	96. 5 ~ 99. 4	HN-356			FN-1170
	W/ ABS No. ~508000	94. 8 ~ 96. 5	HN-225			FN-1198
	W/ ABS No. 508001~	96. 5 ~ 99. 4	HN-356			FN-1198
BJ5P	LS	98. 4 ~ 03. 9	HN-425		HN-476	FN-3394
	LS 4WD	98. 4 ~ 03. 9	HN-239		HN-203	
	RS	00.10 ~ 03. 9	HN-239		HN-476	
BJ5W	2WD	98. 4 ~ 00.10	HN-425		HN-476	FN-3394
	4WD	98. 4 ~ 00.10	HN-239		HN-203	
	S-f	00.10 ~ 03. 9	HN-425		HN-476	FN-3394
	RS	00.10 ~ 03. 9	HN-239		HN-476	
	S-4	00.10 ~ 03. 9	HN-239		HN-203	
BV FY11, BVGY11	VAN W/O ABS	99. 5 ~	HN-435			FN-1170
	W/ ABS	99. 5 ~	HN-435			FN-1198
BW FY11	STATION WAGON W/O ABS	99. 5 ~	HN-435			FN-1170
	W/ ABS	99. 5 ~	HN-435			FN-1198
BVY12		07. 1 ~	HN-452			FN-1264
1600 BF6M		85.11 ~ 94. 8	HN-138		HN-353	FN-3358
BG6P, BG6S		89. 2 ~ 91. 1	HN-232		HN-353	
BG6R		89. 8 ~ 96. 1	HN-232		HN-353	
BG6Z		89. 8 ~ 94. 3	HN-232		HN-353	
BHA6R		94. 9 ~ 98. 5	HN-230		HN-365	FN-3385
BFMR	4WD TURBO	84.11 ~ 89. 2			HN-353	FN-3356
	W/O TURBO	84.11 ~ 89. 2	HN-138		HN-353	FN-3356
BWMR		85.11 ~ 94. 8	HN-138		HN-365	FN-3356
1700 BF7P		84.11 ~ 89. 2	HN-138		HN-353	FN-3356
BG7P		89. 2 ~ 94. 3	HN-232			FN-3373
BW7W		89.10 ~ 94. 8	HN-138			FN-3356
BF7V		85.11 ~ 94. 8	HN-138			FN-3358
BVSY10	VAN W/O ABS	94. 8 ~ 97. 5	HN-375			FN-1170
	W/ ABS	94. 8 ~ 97. 5	HN-225			FN-1198
BVSNY10	VAN	94. 8 ~ 97. 5	HN-225			FN-1170
BHA7P		94. 9 ~ 99. 5	HN-230		HN-365	FN-3385

- NISSAN
- TOYOTA
(HINO)
- MAZDA
- ISUZU
- HONDA
- MITSUBISHI
- SUBARU
- SUZUKI
- DAIHATSU
- LEXUS
- INFINITY
- HYUNDAI
- KIA

MAZDA - 16

- NISSAN
- TOYOTA
(HINO)
- MAZDA**
- ISUZU
- HONDA
- MITSUBISHI
- SUBARU
- SUZUKI
- DAIHATSU
- LEXUS
- INFINITI
- HYUNDAI
- KIA

Model 車種形式	Year 年式	Front フロント		Rear リア		Parking パーキング
		Pad パッド	Shoe シュー	Pad パッド	Shoe シュー	Shoe シュー
FAMILIA						
1700 BHA7R	94. 9 ~ 98. 5	HN-230		HN-365	FN-3385	
1800 BG8R	89. 8 ~ 94. 3	HN-230		HN-353		
BG8Z GT-X No. ~300000	89. 8 ~ 94. 4	HN-230		HN-198		
BG8Z No. 300001~	89. 8 ~ 94. 4	HN-230		HN-353		
GT-R, GT-AE	92. 1 ~ 94. 4	HN-300		HN-203		
BG8P No. ~300001	90. 3 ~ 91. 1	HN-230		HN-198		
BG8P No. 300002~	90.12 ~ 94. 4	HN-230		HN-353		
BHA8P, BHA8S	94. 5 ~ 99. 5	HN-230		HN-365	FN-3385	
BWHY10 STATION WAGON W/O ABS No. 508001~	96. 5 ~ 99. 4	HN-356			FN-1170	
W/ ABS No. 508001~	96. 5 ~ 99. 4	HN-356			FN-1198	
BWHNY10 STATION WAGON W/O ABS No. 508001~	96. 5 ~ 99. 4	HN-356			FN-1170	
BWHNY10 W/ ABS No. 508001~	96. 5 ~ 99. 4	HN-356			FN-1198	
BJ8W S-STATION WAGON	98. 5 ~ 00.10	HN-239		HN-203		
BVHNY11 VAN	99. 5 ~ 06.12	HN-435			FN-1170	
BWHNY11 STATION WAGON	99. 5 ~ 99.12	HN-435			FN-1170	
BVJY12	07. 1 ~	HN-452			FN-1264	
2000 BWEY10 STATION WAGON W/O ABS	94. 8 ~ 99. 4	HN-375			FN-1185	
W/ ABS	94. 8 ~ 99. 4	HN-225			FN-1198	
STATION WAGON W/O ABS No. 508001~	96. 5 ~ 99. 4	HN-356			FN-1185	
W/ ABS No. 508001~	96. 5 ~ 99. 4	HN-356			FN-1198	
BVEY10 VAN W/O ABS No. 513001~	97. 5 ~ 99. 4	HN-225			FN-1170	
W/ ABS No. 513001~	97. 5 ~ 99. 4	HN-225			FN-1198	
BVENY10 VAN No. 513001~	97. 5 ~ 99. 4	HN-225			FN-1170	
BJEP	98. 4 ~ 00.10	HN-425			FN-3394	
BJFW STATION WAGON 2WD AT	99. 6 ~ 03. 9	HN-239		HN-476	FN-3394	
STATION WAGON 4WD MT	99. 6 ~ 03. 9	HN-239		HN-203		
BJFP	00. 9 ~ 03.10	HN-239		HN-476		
2200 BVEY11 VAN W/O ABS	99. 5 ~ 06.12	HN-435			FN-1170	
W/ ABS	99. 5 ~ 06.12	HN-435			FN-1198	
BVENY11 VAN	99. 5 ~ 06.12	HN-435			FN-1170	
FESTIVA						
1100 DA1PF	85.10 ~ 93. 1	HN-165			FN-3369	
1300 DA3PF	85.10 ~ 93. 1	HN-165			FN-3369	
DA3VF	86.10 ~ 93. 1	HN-165			FN-3369	
DAJPF	86.10 ~ 93. 1	HN-165			FN-3369	
ADA242	89. 4 ~ 94. 5	HN-165			FN-3369	
D23PF W/O ABS	92.11 ~ 97.10	HN-232			FN-3387	
W/ ABS	92.11 ~ 97.10	HN-232			FN-3388	
DW3WF W/O ABS	96. 7 ~ 02. 6	HN-232			FN-3387	
W/ ABS	96. 7 ~ 02. 6	HN-232			FN-3388	
1500 D25PF W/O ABS	92.11 ~ 97.10	HN-232			FN-3387	
W/ ABS	92.11 ~ 97.10	HN-232			FN-3388	
DW5WF W/O ABS	96. 7 ~ 02. 6	HN-232			FN-3387	

MAZDA - 17

Model 車種形式	Year 年式	Front フロント		Rear リア		Parking パーキング
		Pad パッド	Shoe シュー	Pad パッド	Shoe シュー	Shoe シュー
FESTIVA						
1500 DW5WF W/ ABS	96. 7 ~ 02. 6	HN-232				FN-3388
PREMACY						
1800 CP8W 2WD	99. 2 ~ 05. 2	HN-239				
4WD	99. 2 ~ 05. 2	HN-239		HN-203		
2000 CPEW	01. 6 ~ 05. 2	HN-239		HN-203		
CREW	05. 2 ~ 10. 7	HN-507		HN-578		
CWEFW	10. 7 ~	HN-507		HN-578		
CWEAW	10. 8 ~	HN-507		HN-578		
CWFFW	13.12 ~	HN-507		HN-578		
2300 CR3W	05. 2 ~ 10. 7	HN-507		HN-578		
PROBE						
2200 BT22, PT22	88. 5 ~ 92. 9	HN-194		HN-195		
2500 CT22	92. 9 ~ 97.12	HN-239		HN-238		
3500 IZVBT, PT21	89.11 ~ 92. 9	HN-194		HN-195		
PROCEEDLEVANTE						
2000 TF11W No. 100001~100192	95. 2 ~ 96. 9	HN-382				FN-9965
No. 100092~	95. 2 ~ 96. 9	HN-382				FN-9947
TJ11W No. 100001~100641	95. 1 ~ 97.11	HN-382				FN-9965
No. 100642~	95. 2 ~ 96. 9	HN-382				FN-9947
TF31W No. 100001~100228	95. 1 ~ 96. 9	HN-382				FN-9965
No. 100229~	95. 1 ~ 96. 9	HN-382				FN-9947
TJ31W No. 100001~100717	95. 1 ~ 97.11	HN-382				FN-9965
No. 100718~	95. 1 ~ 97.11	HN-382				FN-9947
TF51W, TJ51W	96.10 ~ 97.11	HN-382				FN-9947
TF52W, TJ52W	97.11 ~ 99. 9	HN-301				FN-9958
TJ32W	98. 2 ~ 99. 9	HN-382				FN-9958
2500 TJ61W	96.10 ~ 97.11	HN-382				FN-9947
TJ62W	98. 2 ~ 99. 9	HN-382				FN-9958
PROCEED・PROCEED MARVIE						
2500 UV56R	96. 2 ~ 99. 2	HN-334				FN-3378
UVL6R	96. 2 ~ 99. 2	HN-334				FN-3378
2600 UF66M No. ~200260	89.11 ~ 96. 5	HN-297				FN-3378
No. 200261~	96. 2 ~ 99. 2	HN-334				FN-3378
UV66R	90.12 ~ 96. 1	HN-297				FN-3378
PERSONA						
1800 MA8P	88.10 ~ 92. 3	HN-194				FN-3372
2000 MAEP	88.10 ~ 92. 3	HN-194		HN-195		

NISSAN

TOYOTA
(HINO)

MAZDA

ISUZU

HONDA

MITSUBISHI

SUBARU

SUZUKI

DAIHATSU

LEXUS

INFINITY

HYUNDAI

KIA

MAZDA - 18

- NISSAN
- TOYOTA
(HINO)
- MAZDA**
- ISUZU
- HONDA
- MITSUBISHI
- SUBARU
- SUZUKI
- DAIHATSU
- LEXUS
- INFINITI
- HYUNDAI
- KIA

Model 車種形式		Year 年式	Front フロント		Rear リア		Parking パーキング
			Pad パッド	Shoe シュー	Pad パッド	Shoe シュー	Shoe シュー
VERISA							
1500	DC5W		04. 6 ~	HN-495			FN-3421
	DC5R 4WD		04. 6 ~	HN-495			FN-3421
PORTER							
360	PC4D, PC56T		77. 2 ~ 89. 4		FN-3330		FN-3316
BONGO							
1400	SE48T	SINGLE TYRE	83. 9 ~ 99. 5	HN-211			FN-3348
		DOUBLE TYRES	83. 9 ~ 99. 5	HN-211			FN-3351
	SS48V	SINGLE TYRE	83. 9 ~ 99. 5	HN-211			FN-3348
		DOUBLE TYRES	83. 9 ~ 99. 5	HN-211			FN-3351
1500	SE58T	SINGLE TYRE	90. 7 ~ 95. 9	HN-211	FN-3327		FN-3348
		DOUBLE TYRES	90. 7 ~ 95. 9	HN-211	FN-3327		FN-3351
	SS58V	SINGLE TYRE	90. 7 ~ 95. 9	HN-211	FN-3327		FN-3348
		DOUBLE TYRES	90. 7 ~ 95. 9	HN-211	FN-3327		FN-3351
1800	SE88M		85. 9 ~ 99. 5	HN-211	FN-3327		FN-3350
			84.10 ~ 99. 5	HN-211	FN-3327		FN-3348
	SS88M	SINGLE TYRE	95. 8 ~ 99. 5	HN-211			FN-3348
		DOUBLE TYRES	95. 8 ~ 96. 5	HN-211			FN-3351
	SS88H	SINGLE TYRE	96. 9 ~ 99. 5	HN-211			FN-3348
		DOUBLE TYRES	96. 9 ~ 99. 5	HN-211			FN-3351
	SK82T, SK82L		99. 5 ~ 07. 8	HN-332			FN-3410
			07. 8 ~	HN-332			FN-3426
	SK82M, SK82V		99. 5 ~ 07. 8	HN-332			FN-3410
			07. 8 ~	HN-332			FN-3426
2000	SEF8T	SINGLE TYRE	84. 4 ~ 93. 9	HN-211	FN-3327		FN-3348
		DOUBLE TYRES	84. 4 ~ 93. 9	HN-211	FN-3327		FN-3351
	SSE8R		86.11 ~ 95. 9	HN-211	FN-3327		FN-3348
			86.11 ~ 95. 9	HN-211	FN-3327		FN-3348
	SSF8V	SINGLE TYRE	83. 9 ~ 95. 9	HN-211	FN-3327		FN-3348
		DOUBLE TYRES	83. 9 ~ 95. 9	HN-211	FN-3327		FN-3351
	SSF8W, SSF8R	SINGLE TYRE	83. 9 ~ 93. 8	HN-211			FN-3348
		DOUBLE TYRES	83. 9 ~ 93. 8	HN-211			FN-3351
	SKF2T	SINGLE TYRE	No. ~100341	03.12 ~ 07. 8	HN-332		FN-3410
		DOUBLE TYRES	No. 100342~	03.12 ~	HN-332		FN-3426
	SKF2L	0.85t/WIDE LOW SINGLE TYRE	No. ~100074	03.12 ~ 07. 8	HN-332		FN-3410
		0.85t/WIDE LOW SINGLE TYRE	No. 100075~	03.12 ~	HN-332		FN-3426
	SKF2M	1t/WIDE LOW DOUBLE TYRES	03.12 ~ 04.11	HN-332			FN-3426
			No. ~100320	03.12 ~ 07. 8	HN-332		FN-3410
	SKF2V		No. 100321~	03.12 ~	HN-332		FN-3426
			No. ~100764	03.12 ~ 07. 8	HN-332		FN-3410
			No. 100765~	03.12 ~	HN-332		FN-3426
2200	SE28M		87. 9 ~ 99. 5	HN-211	FN-3327		FN-3350
	SS28M		86.11 ~ 99. 5	HN-211	FN-3327		FN-3348
	SS28V, SE28T	SINGLE TYRE	93. 8 ~ 99. 5	HN-211			FN-3348

MAZDA - 19

Model 車種形式	Year 年式	Front フロント		Rear リア		Parking パーキング
		Pad パッド	Shoe シュー	Pad パッド	Shoe シュー	Shoe シュー
BONGO						
2200 SS28V, SE28T	DOUBLE TYRES	93. 8 ~ 99. 5	HN-211			FN-3351
SS28H	SINGLE TYRE	96. 9 ~ 99. 5	HN-211			FN-3348
	DOUBLE TYRES	96. 9 ~ 99. 5	HN-211			FN-3351
SK22T, SK22L		99. 5 ~ 03.12	HN-332			FN-3410
SK22M, SK22V		99. 5 ~ 03.12	HN-332			FN-3410
BONGO FRIENDEE・FREDA						
2000 SGEW, SGEWF		95. 5 ~ 05.11	HN-376		HN-290	
SGE3, SGE3F		97.11 ~ 05.11	HN-376		HN-290	
2500 SG5W, SG5WF		95. 5 ~ 02. 8	HN-376		HN-290	
SGLW, SGLWF, SGLR, SGLRF		95. 5 ~ 05.11	HN-376		HN-290	
SGL3, SGL3F, SGL5, SGL5F		95. 5 ~ 05.11	HN-376		HN-290	
BONGO BRAUNY						
1800 SD89T	SINGLE TYRE	83.12 ~ 99. 6	HN-211	FN-3355		FN-3349
	DOUBLE TYRES	83.12 ~ 99. 6	HN-211	FN-3355		FN-3350
SR89V	SINGLE TYRE	83. 5 ~ 93. 8	HN-211	FN-3355		FN-3349
	DOUBLE TYRES	83. 5 ~ 93. 8	HN-211	FN-3355		FN-3350
2000 SDEAT	SINGLE TYRE	83.12 ~ 99. 6	HN-211	FN-3355		FN-3349
	DOUBLE TYRES	83.12 ~ 99. 6	HN-211	FN-3355		FN-3350
SREAV, SREAM	SINGLE TYRE	83. 5 ~ 99. 6	HN-211	FN-3355		FN-3349
	DOUBLE TYRES	83. 5 ~ 99. 6	HN-211	FN-3355		FN-3350
SRE9V	SINGLE TYRE	85. 7 ~ 97. 5	HN-211	FN-3355		FN-3349
	DOUBLE TYRES	85. 7 ~ 97. 5	HN-211	FN-3355		FN-3350
SRE9W, SRF9W	SINGLE TYRE	83. 5 ~ 95. 9	HN-211	FN-3355		FN-3349
	DOUBLE TYRES	83. 5 ~ 95. 9	HN-211	FN-3355		FN-3350
SKE4T TRUCK		99. 6 ~ 00.10	HN-376			FN-3407
DOUBLE CABIN		99. 6 ~ 00.10	HN-376			FN-3407
SKE6T		99. 6 ~ 00.10	HN-376			FN-3407
SKE6V SINGLE TYRE	No. ~302350	99. 6 ~ 07. 8	HN-376			FN-3406
SINGLE TYRE	No. 302351~	99. 6 ~ 07. 8	HN-376			FN-3425
DOUBLE TYRES	No. ~302350	99. 6 ~ 07. 8	HN-376			FN-3407
DOUBLE TYRES	No. 302351~	99. 6 ~ 07. 8	HN-376			FN-3426
SKF6V SINGLE TYRE		04.11 ~ 07. 8	HN-376			FN-3425
DOUBLE TYRES	No. ~100108	04.11 ~ 07. 8	HN-376			FN-3426
DOUBLE TYRES	No. 100109~	04.11 ~ 07. 8	HN-376			FN-3426
SKF6M		03.12 ~ 04. 2	HN-376			FN-3425
SKFHM, SKFHV		04.11 ~ 07. 8	HN-376			FN-3425
2200 SD2AT	SINGLE TYRE	83.12 ~ 99. 6	HN-211	FN-3355		FN-3349
	DOUBLE TYRES	83.12 ~ 99. 6	HN-211	FN-3355		FN-3350
SD29M	SINGLE TYRE	87. 9 ~ 99. 6	HN-211	FN-3355		FN-3349
	DOUBLE TYRES	87. 9 ~ 99. 6	HN-211	FN-3355		FN-3350
SD29T	SINGLE TYRE	83.12 ~ 99. 6	HN-211	FN-3355		FN-3349
	DOUBLE TYRES	83.12 ~ 99. 6	HN-211	FN-3355		FN-3350
SR29V	SINGLE TYRE	83. 5 ~ 97. 5	HN-211	FN-3355		FN-3349
	DOUBLE TYRES	83. 5 ~ 97. 5	HN-211	FN-3355		FN-3350

- NISSAN
- TOYOTA (HINO)
- MAZDA
- ISUZU
- HONDA
- MITSUBISHI
- SUBARU
- SUZUKI
- DAIHATSU
- LEXUS
- INFINITY
- HYUNDAI
- KIA

MAZDA - 20

- NISSAN
- TOYOTA
(HINO)
- MAZDA**
- ISUZU
- HONDA
- MITSUBISHI
- SUBARU
- SUZUKI
- DAIHATSU
- LEXUS
- INFINITI
- HYUNDAI
- KIA

Model 車種形式	Year 年式	Front フロント		Rear リア		Parking パーキング
		Pad パッド	Shoe シュー	Pad パッド	Shoe シュー	Shoe シュー
BONGO BRAUNY						
2200 SR2AM	87. 9 ~ 97. 5	HN-211	FN-3355		FN-3349	
SR2AV	SINGLE TYRE 83. 5 ~ 97. 5	HN-211	FN-3355		FN-3349	
	DOUBLE TYRES 83. 5 ~ 97. 5	HN-211	FN-3355		FN-3350	
SD2AM	90. 8 ~ 99. 6	HN-211			FN-3350	
SK24T, SK24L	99. 6 ~ 00.10	HN-376			FN-3407	
SK26T, SK26L	99. 6 ~ 00.10	HN-376			FN-3407	
2500						
SR5AV, SR59V	SINGLE TYRE 97. 4 ~ 99. 6	HN-211			FN-3349	
	DOUBLE TYRES 97. 4 ~ 99. 6	HN-211			FN-3350	
SR5AM	97. 4 ~ 99. 6	HN-211			FN-3349	
SD5AT, SD59T	SINGLE TYRE 97. 4 ~ 99. 6	HN-211			FN-3349	
	DOUBLE TYRES 97. 4 ~ 99. 6	HN-211			FN-3350	
SD5AM, SD59M	SINGLE TYRE 97. 4 ~ 99. 6	HN-211			FN-3349	
	DOUBLE TYRES 97. 4 ~ 99. 6	HN-211			FN-3350	
SK54V, SK56V	SINGLE TYRE 99. 6 ~ 04.11	HN-376			FN-3406	
	DOUBLE TYRES 99. 6 ~ 04.11	HN-376			FN-3407	
SK5HV, SK5HM	99. 6 ~ 04.11	HN-376			FN-3406	
SK54L, SK56M	SINGLE TYRE 99. 6 ~ 04.11	HN-376			FN-3406	
	DOUBLE TYRES 99. 6 ~ 04.11	HN-376			FN-3407	
SK54T	SINGLE TYRE 99. 6 ~ 00.10				FN-3406	
	DOUBLE TYRES 99. 6 ~ 00.10				FN-3407	
SK56T, SK56L	SINGLE TYRE 99. 6 ~ 00.10	HN-376			FN-3406	
	DOUBLE TYRES 99. 6 ~ 00.10	HN-376			FN-3407	
3000						
SRS9V, SRS9V	SINGLE TYRE 92. 2 ~ 97. 5	HN-211			FN-3349	
	DOUBLE TYRES 92. 2 ~ 97. 5	HN-211			FN-3350	
MILENIA(EUNOS 800)						
2000 TAFP	98. 6 ~ 02.10	HN-334		HN-335		
2300 TAG, TA3A, TASP, TAGY, TA3Z MC	93. 8 ~ 00. 7	HN-334		HN-335		
2500 TA5, TA5A, TA5P, TA5Y, YA5Z	93. 8 ~ 03. 8	HN-334		HN-335		
EUNOS 100						
1500 BG5PE	89.10 ~ 94. 6	HN-232			FN-3373	
1800 BG8PE	89.10 ~ 94. 6	HN-230		HN-198		
EUNOS 300						
1800 MA8PE	89.11 ~ 92. 3	HN-194		HN-195		
2000 MAEPE	89.11 ~ 92. 3	HN-194		HN-195		
EUNOS 500						
1800 CA8P, CA8PE, CAPP	91.12 ~ 96. 1	HN-239		HN-238		
2000 CAEP, CAEPE	91.12 ~ 96. 1	HN-239		HN-238		
EUNOS COSMO						
JC3S, JCES	94. 2 ~ 95.10	HN-300		HN-290		
JC3SE, JCESE WANKEL ENGINE	90. 3 ~ 94. 2	HN-300		HN-290		

MAZDA - 21

Double-lined items are discontinued.

Model 車種形式	Year 年式	Front フロント		Rear リア		Parking パーキング
		Pad パッド	Shoe シュー	Pad パッド	Shoe シュー	Shoe シュー
EUNOS PRESSO						
1500 EC5S	93. 9 ~ 98. 1	HN-230		HN-353	FN-3385	
800 EC8SE	91. 4 ~ 93.10	HN-230		HN-198		
EC8S GT	91. 4 ~ 98. 1	HN-230		HN-353		
HIX	91. 4 ~ 98. 1	HN-230		HN-198		
EUNOS CARGO						
1500 SE58TE TRUCK	90. 1 ~ 93. 9	HN-211	FN-3327		FN-3348	
SEF8TE TRUCK	90. 1 ~ 93. 9	HN-211	FN-3327		FN-3351	
EUNOS CARGO						
2000 SSE8WE STATION WAGON	90. 1 ~ 93. 9	HN-211			FN-3348	
SSF8RE STATION WAGON	90. 1 ~ 93. 9	HN-211			FN-3348	
SSF8WE STATION WAGON	90. 1 ~ 93. 9	HN-211			FN-3348	
SSF8VE PICKUP TRUCK SINGLE TYRE	90. 1 ~ 93. 9	HN-211	FN-3327		FN-3348	
PICKUP TRUCK DOUBLE TYRES	90. 1 ~ 93. 9	HN-211	FN-3327		FN-3351	
SS58VE PICKUP TRUCK SINGLE TYRE	90. 1 ~ 93. 9	HN-211	FN-3327		FN-3348	
PICKUP TRUCK DOUBLE TYRES	90. 1 ~ 93. 9	HN-211	FN-3327		FN-3351	
2200 SS28ME PICKUP TRUCK	89.11 ~ 93. 9	HN-211	FN-3327		FN-3348	
SE28ME TRUCK	89.11 ~ 93. 9	HN-211	FN-3327		FN-3350	
LAPUTA						
660 HP11S, HP21S	99. 3 ~ 01. 3	HN-426			FN-9959	
HP12S, HP22S	01. 4 ~ 01.10	HN-426			FN-9959	
HP22S W/O TURBO	03. 9 ~ 04.12	HN-426			FN-9967	
	04.12 ~ 05.12	HN-566			FN-9967	
W/ TURBO	03. 9 ~ 05.12	HN-426			FN-9967	
LANTIS						
1800 CBA8P	93. 8 ~ 97. 6	HN-230		HN-365		
2000 CBAEP	93. 8 ~ 97. 6	HN-300		HN-365		
LUCE						
HBEJ, HBES	81.10 ~ 86. 9			HN-203	FN-3342	
HBP8, HBPS2, HBSN2, HB3S	81.10 ~ 86. 9			HN-203	FN-3342	
HBEP, HBPHE TAXI FRONT DRUM	81.10 ~ 86. 9		FN-3363		FN-3379	
FRONT DISK	81.10 ~ 86. 9				FN-3352	
LA4MV, LA4SV	81.12 ~ 87. 9	HN-063			FN-3332	
HCEJ, HC2J TRAINING VEHICLES	86. 7 ~	HN-167		HN-168	FN-3374	
2000 HCEP No. ~102502	86. 7 ~ 92. 3	HN-386			FN-3365	
No. 102503~	86. 7 ~ 92. 3	HN-386			FN-3374	
TAXI	86. 8 ~ 96. 1	HN-386			FN-3365	
HCFS	86. 7 ~ 92. 3	HN-386		HN-168		
3000 HCSS	86. 7 ~ 92. 3	HN-386		HN-168		
HC3S WANKEL ENGINE	86. 7 ~ 92. 3	HN-386		HN-168		
LASER						
1300 BF3PF	82. 9 ~ 85. 1	HN-070			FN-3329	
BFTPF	84.11 ~ 89. 3	HN-138			FN-3356	
BF3VF	85.11 ~ 94. 8	HN-138			FN-3358	

NISSAN

TOYOTA
(HINO)

MAZDA

ISUZU

HONDA

MITSUBISHI

SUBARU

SUZUKI

DAIHATSU

LEXUS

INFINITY

HYUNDAI

KIA

MAZDA - 22

- NISSAN
- TOYOTA
(HINO)
- MAZDA**
- ISUZU
- HONDA
- MITSUBISHI
- SUBARU
- SUZUKI
- DAIHATSU
- LEXUS
- INFINITI
- HYUNDAI
- KIA

Model 車種形式	Year 年式	Front フロント		Rear リア		Parking パーキング
		Pad パッド	Shoe シュー	Pad パッド	Shoe シュー	Shoe シュー
LASER						
1300 BG3PF	No. ~300278	89. 3 ~ 94. 3	HN-232			FN-3373
	No. 300279~	90.11 ~ 94. 3	HN-232			FN-3385
BHA3PF		96. 8 ~ 98.10	HN-232		HN-365	FN-3385
BJ3PF		98.12 ~ 00.12	HN-425			FN-3394
1500 BF5PF, BF5RF, BF5SF		84.11 ~ 89. 3	HN-138			FN-3356
BF5VF		85.11 ~ 94. 8				
1500 BFSPF, BFSRF, BF7PP		84.11 ~ 89. 3	HN-138			FN-3356
BG5PF	No. ~302497	89. 3 ~ 94. 3				
	No. 302498~	89. 3 ~ 94. 3				
BHALPF		94. 4 ~ 98.10	HN-232		HN-365	FN-3385
BHALSF		94. 4 ~ 98.10	HN-232		HN-365	FN-3385
BHA5PF		94. 4 ~ 96. 9	HN-230		HN-365	FN-3385
BHA5SF		94. 4 ~ 96. 9	HN-230		HN-365	FN-3385
BJ5PF, BJ5WF	2WD MT	98.12 ~ 00.12	HN-425			FN-3394
	4WD AT	98.12 ~ 00.12	HN-239		HN-203	
1600 BFMPF, BFMRF		84.11 ~ 89. 3	HN-138			FN-3356
BG6PF		89. 3 ~ 91. 1	HN-232		HN-353	
BG6RF		89. 8 ~ 94. 3	HN-232		HN-353	
BF6MF		89.10 ~ 94. 8	HN-138		HN-353	
BHA6RF		94. 9 ~ 98. 5	HN-230		HN-365	FN-3385
1700 BG7PF	No. ~110171	89. 3 ~ 94. 3	HN-232			FN-3373
	No. 110172~	89. 3 ~ 94. 3	HN-232			FN-3385
BHA7PF		94. 9 ~ 98. 5	HN-230		HN-365	FN-3385
BHA7RF		94. 9 ~ 96. 9	HN-230		HN-365	FN-3385
1800 BG8PF		90.11 ~ 94. 1	HN-230		HN-353	
BG8RF		89. 3 ~ 94. 4	HN-230		HN-198	
BHA8PF		94. 4 ~ 98.10	HN-230		HN-365	FN-3385
BHA8SF		94. 4 ~ 95. 8	HN-230		HN-365	
BJ8WF		98.12 ~ 00.12	HN-239		HN-203	
2000 BJEPP		98.12 ~ 00.12	HN-425			FN-3394
REVUE						
1300 DB3PA		90. 8 ~ 99. 2	HN-232			FN-3387
1500 DB5PA	W/O ABS	No. 200692~	90. 8 ~ 99. 2	HN-232		FN-3387
	W/ ABS	No. 200692~	90. 8 ~ 99. 2	HN-232		FN-3388
ROADSTER						
1600 NA6CE		89. 6 ~ 93. 8	HN-253		HN-198	
NB6C		97.12 ~ 05. 8	HN-364		HN-365	
	NRA	00. 6 ~ 05. 8	HN-486		HN-487	
1800 NA8C		93. 8 ~ 97.11	HN-364		HN-365	
NB8C		97.12 ~ 05. 8	HN-364		HN-365	
	RS, HERD SUSPENSION	00. 6 ~ 05. 8	HN-486		HN-487	
000 NCEC		05. 8 ~				

ISUZU - 1

Model 車種形式			Year 年式	Front フロント		Rear リア		Parking パーキング
				Pad パッド	Shoe シュー	Pad パッド	Shoe シュー	Shoe シュー
ASKA								
1800	BCK	W/O ABS	90. 9 ~ 93. 9	HN-248			FN-7744	
		W/ ABS	90. 9 ~ 93. 9	HN-248		HN-249		
	CJ2		97. 9 ~ 02. 3	HN-423		HN-397		
2000 BCL . BCM								
	CJ1		94. 3 ~ 02. 3	HN-223		HN-397	FN-5520	
	CJ3		97. 9 ~ 02. 3	HN-254		HN-397		
ELF								
2000	ASK2F23	1t	SINGLE TIRE	95. 6 ~ 99. 6	HN-105		FN-1210	
		1.5t	DOUBLE TIRE	97. 8 ~ 99. 6	HN-446		FN-1163	
	ASK4F23	1t	SINGLE TIRE	97. 8 ~ 99. 6	HN-446		FN-1208	
		1.25t	DOUBLE TIRE	97. 8 ~ 99. 6	HN-446		FN-1163	
		1.5t	SINGLE TIRE	97. 8 ~ 99. 6	HN-446		FN-1208	
		1.5t	DOUBLE TIRE	97. 8 ~ 99. 6	HN-446		FN-1163	
	ASH2F23	1t	DOUBLE TIRE	99. 6 ~ 04. 5	HN-137		FN-1163	
		1.3t	SINGLE TIRE	99. 6 ~ 02. 8	HN-137		FN-1210	
		1.3t	SINGLE TIRE	02. 8 ~	HN-137		FN-1174	
		1.5t	DOUBLE TIRE	99. 6 ~	HN-446		FN-1163	
	ASH4F23	0.75t	SINGLE TIRE	99. 6 ~	HN-446		FN-1163	
		1.25t	DOUBLE TIRE	99. 6 ~	HN-446		FN-1163	
		1.5t	SINGLE TIRE, W/O ABS	99. 6 ~	HN-446		FN-1179	
		1.5t	SINGLE TIRE, W/ ABS	99. 6 ~	HN-446		FN-1208	
		1.5t	DOUBLE TIRE	99. 6 ~	HN-446			
	ASQ1F24		SINGLE TIRE	07. 7 ~	HN-475		FN-1208	FN-1244
			DOUBLE TIRE	07. 7 ~	HN-475		FN-6655	FN-1244
	ASQ2F24	1.25t	SINGLE TIRE	07. 7 ~	HN-475		FN-1208	FN-1244
		1.25t	DOUBLE TIRE	07. 7 ~	HN-475		FN-6655	FN-1244
2500								
	NHR54		SINGLE TIRE	84. 7 ~ 93. 6	HN-289	FN-4434	FN-4434	FN-4404
		FLATLOW		84. 7 ~ 93. 6	HN-289	FN-4434	FN-4428	FN-4404
	ASN2F23	0.85t	SINGLE TIRE	95. 6 ~ 99. 6	HN-137		FN-1210	
		1t	SINGLE TIRE	95. 6 ~ 99. 6	HN-105		FN-1210	
		1t	DOUBLE TIRE	95. 6 ~ 99. 6	HN-105		FN-1163	
	ASN6F23		SINGLE TIRE	95. 6 ~ 99. 6	HN-137		FN-1210	
2700								
	ASP8F23			95. 6 ~ 97. 8	HN-204		FN-1208	
	ASP2F23	1.3t	SINGLE TIRE	99. 6 ~ 02. 8	HN-137		FN-1210	
		1.3t	SINGLE TIRE	02. 8 ~ 04. 8	HN-137		FN-1174	
		1.3t	DOUBLE TIRE	99. 6 ~ 02. 8	HN-137		FN-1163	
		1t	DOUBLE TIRE	99. 6 ~ 04. 8	HN-137		FN-1163	
	ASP6F23	0.75t	SINGLE TIRE	99. 6 ~ 02. 8	HN-137		FN-1210	
		0.75t	SINGLE TIRE	02. 8 ~ 04. 8	HN-137		FN-1174	
2800								
	NHR55		SINGLE TIRE	84. 7 ~ 93. 6	HN-289	FN-4434	FN-4434	FN-4404
		FLATLOW		84. 7 ~ 93. 6	HN-289	FN-4434	FN-4428	FN-4404
	NKR55		SINGLE TIRE	84. 7 ~ 90. 6		FN-4402	FN-4402	FN-4404
		LOW FLOOR	DOUBLE TIRE	84. 7 ~ 90. 6	HN-288	FN-4402	FN-4428	FN-4404
		HIGH FLOOR	DOUBLE TIRE	88. 6 ~ 90. 6	HN-288	FN-4425	FN-4425	FN-4404

- NISSAN
- TOYOTA
(HINO)
- MAZDA
- ISUZU**
- HONDA
- MITSUBISHI
- SUBARU
- SUZUKI
- DAIHATSU
- LEXUS
- INFINITY
- HYUNDAI
- KIA

ISUZU - 2

- NISSAN
- TOYOTA
(HINO)
- MAZDA
- ISUZU**
- HONDA
- mitsubishi
- subaru
- SUZUKI
- DAIHATSU
- LEXUS
- INFINITY
- HYUNDAI
- KIA

Model 車種形式	Year 年式	Front フロント		Rear リア		Parking パーキング
		Pad パッド	Shoe シュー	Pad パッド	Shoe シュー	Shoe シュー
ELF						
2800 NKR55	FLATLOW					
	1.75t FLATLOW					
	2t FLATLOW					
	2t LONG					
	2t LOW FLOOR					
	2t HIGH FLOOR	SINGLE TIRE				
	2t HIGH FLOOR	DOUBLE TIRE				
WHR55		SINGLE TIRE				
		DOUBLE TIRE				
WKR55						
NHS55		SINGLE TIRE				
		DOUBLE TIRE				
3000 NKR85A	2t HIGH FLOOR DUMP, DUSTCART	DOUBLE TIRE				
	2t HIGH FLOOR, W/O THE ABOVE	DOUBLE TIRE				
	3t HIGH FLOOR	DOUBLE TIRE				
※REAR DRUM FN-4451orFN-4459						
NKR85N	3t HIGH FLOOR	DOUBLE TIRE				
NKR85R	2t,4t HIGH FLOOR	DOUBLE TIRE				
NKR85YN	4t HIGH FLOOR	DOUBLE TIRE				
ASZ1F24	1.25t SUPER LOW	DOUBLE TIRE				
	1.25t FULL SUPER LOW	SINGLE TIRE				
ASZ2F24	1.25t SUPER LOW	DOUBLE TIRE				
	1.25t FULL SUPER LOW	DOUBLE TIRE				
3100 NHR69	FRONT DRUM	SINGLE TIRE				
	FRONT DRUM, FLATLOW	DOUBLE TIRE				
	INDEPENDENT SUSPENSION	SINGLE TIRE				
	INDEPENDENT SUSPENSION	DOUBLE TIRE				
	INDEPENDENT SUSPENSION					
	INDEPENDENT SUSPENSION					
	W/O INDEPENDENT SUSPENSION	SINGLE TIRE				
	W/O INDEPENDENT SUSPENSION	DOUBLE TIRE				
	W/O INDEPENDENT SUSPENSION					
NHS69		SINGLE TIRE				
		SINGLE TIRE				
		SINGLE TIRE				
		DOUBLE TIRE				
		DOUBLE TIRE				
		DOUBLE TIRE				
NKR69	LOW FLOOR-HIGH FLOOR					
	FLATLOW					
	FULL FLAT LOW INDEPENDENT SUS.					
	EXCL. INDEPENDENT SUS.					
	INDEPENDENT SUS.					
	DUSTCART, VACUUM					
	W/O THE ABOVE					
WHR69						
	1.5t					

ISUZU - 3

Model 車種形式	Year 年式	Front フロント		Rear リア		Parking パーキング
		Pad パッド	Shoe シュー	Pad パッド	Shoe シュー	Shoe シュー
ELF						
3100 WKR69	94. 1 ~ 99. 6	HN-384				FN-4428 FN-4404
	99. 7 ~	HN-384				FN-4465 FN-4404
VHR69K	96.11 ~ 99. 6	HN-289				FN-4428 FN-4404
	99. 7 ~	HN-289				FN-4465 FN-4404
3200 ASR2F23	99. 6 ~	HN-446				FN-1163
ASR8F23	W/ ABS 97. 8 ~	HN-446				FN-1208
	W/O ABS 97. 8 ~ 01.07	HN-446				FN-1179
	W/O ABS 01.07 ~	HN-446				FN-1208
3300 NKR57						
	SINGLE TIRE 84. 7 ~ 89. 7		FN-4402			FN-4402 FN-4404
	SINGLE TIRE 84. 7 ~ 89. 7	HN-287				FN-4441 FN-4404
LOW FLOOR	DOUBLE TIRE 84. 7 ~ 89. 7	HN-288	FN-4402			FN-4428 FN-4404
HIGH FLOOR	DOUBLE TIRE 84. 7 ~ 88. 6	HN-287	FN-4425			FN-4425 FN-4404
HIGH FLOOR	DOUBLE TIRE 88. 7 ~ 89. 7	HN-288	FN-4425			FN-4425 FN-4404
FULL FLATLOW	84. 7 ~ 88. 6	HN-287	FN-4447			FN-4447 FN-4404
FULL FLATLOW	88. 7 ~ 89. 7	HN-288	FN-4447			FN-4447 FN-4404
NPR57	FRONT 15inch DOUBLE TIRE 84. 7 ~ 90. 5	HN-288	FN-4425			FN-4425 FN-4404
	FRONT 16inch 84. 7 ~ 90. 5	HN-288	FN-4442			FN-4425 FN-4404
	FRONT 15inch DOUBLE TIRE 84. 7 ~ 90. 5	HN-288	FN-4425			FN-4428 FN-4404
	FRONT 16inch 84. 7 ~ 90. 5	HN-288	FN-4442			FN-4428 FN-4404
3600 NKR58						
	SINGLE TIRE 86. 2 ~ 90. 6		FN-4402			FN-4402 FN-4404
	SINGLE TIRE 86. 2 ~ 90. 6	HN-287				FN-4441 FN-4404
LOW FLOOR	DOUBLE TIRE 84. 7 ~ 90. 6	HN-288	FN-4402			FN-4428 FN-4404
HIGH FLOOR	DOUBLE TIRE 84. 7 ~ 88. 6	HN-287	FN-4425			FN-4425 FN-4404
HIGH FLOOR	DOUBLE TIRE 88. 6 ~ 90. 6	HN-288	FN-4425			FN-4425 FN-4404
FLATLOW	86. 2 ~ 90. 6	HN-288	FN-4447			FN-4447 FN-4404
2t FULL FLATLOW	90. 7 ~ 93. 6	HN-289				FN-4425 FN-4443
2t LONG	90. 7 ~ 93. 6		FN-4425			FN-4425 FN-4443
2t FLATLOW	90. 7 ~ 93. 6	HN-289				FN-4428 FN-4443
2.75t LONG	90. 7 ~ 93. 6		FN-4425			FN-4447 FN-4443
2t LOW FLOOR, HIGH FLOOR	90. 7 ~ 93. 6	HN-289				FN-4402 FN-4443
2t HIGH FLOOR LONG	DOUBLE TIRE 90. 7 ~ 93. 6	HN-288	FN-4425			FN-4425 FN-4443
2.75t HIGH FLOOR LONG	DOUBLE TIRE 90. 7 ~ 93. 6		FN-4425			FN-4425 FN-4443
No.7400001 ~	SINGLE TIRE 93. 7 ~ 99. 4	HN-384				FN-4425 FN-4443
FLATLOW	DOUBLE TIRE 93. 7 ~ 99. 4	HN-384				FN-4428 FN-4443
FULL FLATLOW	DOUBLE TIRE 93. 7 ~ 99. 4	HN-384				FN-4425 FN-4443
HIGH FLOOR	DOUBLE TIRE 93. 7 ~ 99. 4	HN-384				FN-4451 FN-4443
HIGH FLOOR	DOUBLE TIRE 93. 7 ~ 99. 4	HN-384				FN-4458 FN-4443
FRONT DRUM	93. 7 ~ 99. 4		FN-4425			FN-4425 FN-4443
FRONT DRUM	93. 7 ~ 99. 4		FN-4458			FN-4458 FN-4443
NKR63						
	SINGLE TIRE 88. 6 ~ 90. 6		FN-4402			FN-4402 FN-4404
FULL FLATLOW	88. 6 ~ 90. 6		FN-4447			FN-4447 FN-4404
	DOUBLE TIRE 88. 6 ~ 90. 6		FN-4425			FN-4425 FN-4404
2t FULL FLATLOW	90. 7 ~ 93. 6		FN-4425			FN-4425 FN-4443
2t FLATLOW	90. 7 ~ 93. 6		FN-4402			FN-4428 FN-4443
2t HIGH FLOOR	SINGLE TIRE 90. 7 ~ 93. 6		FN-4402			FN-4402 FN-4443
2t HIGH FLOOR	DOUBLE TIRE 90. 7 ~ 93. 6	HN-288	FN-4425			FN-4425 FN-4443

- NISSAN
- TOYOTA (HINO)
- MAZDA
- ISUZU
- HONDA
- MITSUBISHI
- SUBARU
- SUZUKI
- DAIHATSU
- LEXUS
- INFINITY
- HYUNDAI
- KIA

ISUZU - 4

- NISSAN
- TOYOTA (HINO)
- MAZDA
- ISUZU**
- HONDA
- MITSUBISHI
- SUBARU
- SUZUKI
- DAIHATSU
- LEXUS
- INFINITI
- HYUNDAI
- KIA

Model 車種形式	Year 年式	Front フロント		Rear リア		Parking パーキング
		Pad パッド	Shoe シュー	Pad パッド	Shoe シュー	Shoe シュー
ELF						
3600 NKR63	No. 7400001~	DOUBLE TIRE			FN-4451	FN-4443
	FLATLOW	DOUBLE TIRE	93. 7 ~ 99. 4	HN-384		FN-4428 FN-4443
	FULL FLATLOW	DOUBLE TIRE	93. 7 ~ 99. 4	HN-384		FN-4425 FN-4443
	HIGH FLOOR	DOUBLE TIRE	93. 7 ~ 99. 4	HN-384		FN-4425 FN-4443
	HIGH FLOOR	DOUBLE TIRE	93. 7 ~ 99. 4	HN-384		FN-4458 FN-4443
	FRONT DRUM		93. 7 ~ 99. 4		FN-4425	FN-4425 FN-4443
	FRONT DRUM		93. 7 ~ 99. 4		FN-4458	FN-4458 FN-4443
	NKS58		87. 9 ~ 93.10		FN-4442	FN-4442 FN-4443
	NPR58	FRONT 15inch	87. 1 ~ 90. 6	HN-288	FN-4425	FN-4428 FN-4404
		FRONT 15inch	87. 1 ~ 90. 6	HN-288	FN-4442	FN-4442 FN-4404
		2t FULL FLATLOW LONG	90. 7 ~ 93. 6	HN-288	FN-4425	FN-4425 FN-4443
		2t FLATLOW LONG	90. 7 ~ 93. 6	HN-288	FN-4425	FN-4428 FN-4443
		2.75t FLATLOW	90. 7 ~ 93. 6	HN-288	FN-4425	FN-4428 FN-4443
		2t FLATLOW SHORTLONG	90. 7 ~ 93. 6	HN-288	FN-4425	FN-4428 FN-4443
		3t FULL FLATLOW LONG	90. 7 ~ 93. 6		FN-4425	FN-4425 FN-4443
		2.75t FLATLOW SHORTLONG	90. 7 ~ 93. 6		FN-4425	FN-4425 FN-4443
		2t,2.75t,3t HIGH FLOOR	DOUBLE TIRE	90. 7 ~ 93. 6	HN-288	FN-4425 FN-4443
	NPS58		88. 7 ~ 93. 5		FN-4451	FN-4451 FN-4443
	3900 NPR59		84. 7 ~ 93. 6	HN-288	FN-4442	FN-4442 FN-4443
	NPS59		87.12 ~ 93. 5		FN-4451	FN-4451 FN-4443
	4300 NPR61		88. 6 ~ 90. 4	HN-288	FN-4442	※ FN-4443
※REAR DRUM FN-4428orFN-4442orFN-4451						
	NKR66	FULL FLATLOW	90. 8 ~ 93. 6		FN-4425	FN-4425 FN-4443
		2t FULL FLATLOW	90. 8 ~ 93. 6	HN-287	FN-4402	FN-4428 FN-4443
		2t LONG	90. 8 ~ 93. 6		FN-4451	FN-4447 FN-4443
		2t HIGH FLOOR	SINGLE TIRE	90. 8 ~ 93. 6	HN-287	FN-4402 FN-4443
		2t HIGH FLOOR	DOUBLE TIRE	90. 8 ~ 93. 6		FN-4451 FN-4443
		HIGH FLOOR	DOUBLE TIRE	90. 8 ~ 93. 6	HN-288	FN-4442 FN-4443
		2t HIGH FLOOR LONG	DOUBLE TIRE	90. 8 ~ 93. 6	HN-288	FN-4451 FN-4443
		2.75t,3t HIGH FLOOR	DOUBLE TIRE	90. 8 ~ 93. 6		FN-4451 FN-4443
		No. 7400001~	SINGLE TIRE	93. 7 ~ 97. 4	HN-384	FN-4425 FN-4443
		FLATLOW	DOUBLE TIRE	93. 7 ~ 97. 4	HN-384	FN-4428 FN-4443
		FULL FLATLOW, MT	DOUBLE TIRE	93. 7 ~ 97. 4	HN-384	FN-4458 FN-4443
		MT	DOUBLE TIRE	93. 7 ~ 97. 4	HN-384	FN-4458 FN-4443
		AT	DOUBLE TIRE	93. 7 ~ 97. 4	HN-384	FN-4451 FN-4443
		HIGH FLOOR MT	DOUBLE TIRE	93. 7 ~ 97. 4	HN-384	FN-4458 FN-4443
		HIGH FLOOR AT	DOUBLE TIRE	93. 7 ~ 97. 4	HN-384	FN-4451 FN-4443
		2.75t,3t		93. 7 ~ 97. 4		FN-4451 FN-4443
		W/O 2.75t,3t		93. 7 ~ 97. 4		FN-4458 FN-4443
		FLATLOW	DOUBLE TIRE	97. 5 ~ 99. 4	HN-289	FN-4458 FN-4443
		HIGH FLOOR	DOUBLE TIRE	97. 5 ~ 99. 4	HN-384	FN-4451 FN-4443
		DUMP TRUCK	DOUBLE TIRE	97. 5 ~ 99. 4		FN-4458 FN-4443
		CUSTOM CAR		97. 5 ~ 99. 4		FN-4451 FN-4443
		FRONT DRUM		93. 7 ~ 99. 4		FN-4425 FN-4443
		FRONT DRUM		93. 7 ~ 99. 4		FN-4458 FN-4443
		FRONT DRUM		99. 4 ~ 04. 5		FN-4459 FN-4443
		INDEPENDENT SUSPENSION		99. 4 ~ 04. 5		HN-384 FN-4451 FN-4443
		DUSTCART, VACUUM		99. 4 ~ 04. 5		HN-464 FN-4451 FN-4443
		W/O THE ABOVE		99. 4 ~ 04. 5		HN-489 FN-4461 FN-4443

ISUZU - 5

Model 車種形式		Year 年式	Front フロント		Rear リア		Parking パーキング	
			Pad パッド	Shoe シュー	Pad パッド	Shoe シュー	Shoe シュー	
ELF								
4300	NPR66	FULL FLATLOW	90. 8 ~ 93. 6	HN-288	FN-4451		FN-4451	FN-4443
		FRONT DRUM, FULL FLATLOW	90. 8 ~ 93. 6		FN-4451		FN-4447	FN-4443
		FRONT DISC	90. 8 ~ 93. 6	HN-288			FN-4428	FN-4443
		2.75t,3t HIGH FLOOR DOUBLE TIRE	90. 8 ~ 93. 6	HN-288	FN-4451		FN-4451	FN-4443
		3.5t HIGH FLOOR DOUBLE TIRE	90. 8 ~ 93. 6	HN-288	FN-4451		FN-4451	FN-4443
		4t HIGH FLOOR DOUBLE TIRE	90. 8 ~ 93. 6		FN-4459		FN-4459	FN-4443
		FLATLOW	93. 7 ~ 99. 4	HN-288			FN-4447	FN-4443
		2t	93. 7 ~ 99. 4		FN-4451		FN-4447	FN-4443
		3t	93. 7 ~ 99. 4		FN-4451		FN-4425	FN-4443
		FULL FLATLOW	93. 7 ~ 99. 4	HN-288			FN-4451	FN-4443
		2t,3t	93. 7 ~ 99. 4		FN-4451		FN-4451	FN-4443
		3.5t	93. 7 ~ 99. 4		FN-4459		FN-4459	FN-4443
		HIGH FLOOR	93. 7 ~ 99. 4	HN-288			FN-4451	FN-4443
		3.5t,4t	93. 7 ~ 99. 4		FN-4459		FN-4459	FN-4443
		VOLTCAR,75bread	93. 7 ~ 99. 4		FN-4451		FN-4459	FN-4443
		VOLTCAR,100bread	93. 7 ~ 99. 4		FN-4459		FN-4459	FN-4443
		DUMP, DUSTCART	93. 7 ~ 99. 4		FN-4459		FN-4459	FN-4443
		FRONT DRUM	99. 4 ~ 04. 5		FN-4459		FN-4451	FN-4443
		2t	99. 4 ~ 04. 5	HN-489		HN-464	FN-4451	FN-4443
		3t,3.5t	99. 4 ~ 04. 5	HN-464		HN-464	FN-4451	FN-4443
	VKR66K		96.11 ~ 99. 6	HN-384			FN-4428	FN-4443
			99. 7 ~ 02. 6	HN-384			FN-4465	FN-4443
	NKS66		93. 5 ~ 99. 4	HN-384	FN-4451		FN-4451	FN-4443
	NPS66	3.5t	93.12 ~ 95. 2		FN-4451		FN-4459	FN-4443
4600	NKR71	INDEPENDENT SUSPENSION	95. 3 ~ 99. 4	HN-384	FN-4451			FN-4443
		W/O INDEPENDENT SUSPENSION	95. 3 ~ 99. 4	HN-288	FN-4451		FN-4451	FN-4443
		FRONT DRUM	99. 4 ~ 04. 5		FN-4459		FN-4459	FN-4443
		INDEPENDENT SUSPENSION	99. 4 ~ 04. 5	HN-384			FN-4451	FN-4443
		DUSTCART, VACUUM	99. 4 ~ 04. 5	HN-464			FN-4451	FN-4443
		W/O THE ABOVE	99. 4 ~ 04. 5	HN-489			FN-4461	FN-4443
	NKS71		93. 5 ~ 04. 5	HN-384	FN-4451		FN-4451	FN-4443
			93. 5 ~ 04. 5	HN-384	FN-4451		FN-4459	FN-4443
	NPR71		93. 7 ~ 99. 4	HN-288	FN-4451		※	FN-4443
		FRONT DRUM	99. 4 ~ 04. 5		FN-4459		FN-4459	FN-4443
		INDEPENDENT SUSPENSION	99. 4 ~ 04. 5	HN-384			※	FN-4443
		DUSTCART, VACUUM	99. 4 ~ 04. 5	HN-464			※	FN-4443
		W/O THE ABOVE	99. 4 ~ 04. 5	HN-489			※	FN-4443
							※REAR DRUM FN-4447orFN-4451orFN-4459orFN-4461	
	NPS71		95. 3 ~ 97. 3		FN-4451		FN-4459	FN-4443
	NKR81GL	DRYVAN, INDEPENDENT SUSPENSION	02. 4 ~	HN-384	FN-4459		FN-4451	FN-4443
		DRYVAN, W/O INDEPENDENT SUSPENSION	02. 4 ~	HN-464			FN-4459	FN-4443
	NKR82AN, N	DOUBLE TIRE	05. 2 ~	HN-464	FN-4459		FN-4459	FN-4443
	NJR82	2t DOUBLE TIRE	07. 7 ~	HN-543			FN-4461	FN-4443
	NMR82	DOUBLE TIRE	07. 7 ~	HN-464	FN-4459		※	FN-4443
							※REAR DRUM FN-4451orFN-4459	
4800	NPR70	HIGH FLOOR	93. 5 ~ 99. 4	HN-288	FN-4459		FN-4459	FN-4466
		HIGH FLOOR	93. 5 ~ 99. 4	HN-288	FN-4451		FN-4451	FN-4466
		FULL FLATLOW	95. 3 ~ 99. 4	HN-288	FN-4451		FN-4447	FN-4466

- NISSAN
- TOYOTA
(HINO)
- MAZDA
- ISUZU**
- HONDA
- MITSUBISHI
- SUBARU
- SUZUKI
- DAIHATSU
- LEXUS
- INFINITY
- HYUNDAI
- KIA

ISUZU - 6

- NISSAN
- TOYOTA
(HINO)
- MAZDA
- ISUZU**
- HONDA
- MITSUBISHI
- SUBARU
- SUZUKI
- DAIHATSU
- LEXUS
- INFINITI
- HYUNDAI
- KIA

Model 車種形式	Year 年式	Front フロント		Rear リア		Parking パーキング
		Pad パッド	Shoe シュー	Pad パッド	Shoe シュー	Shoe シュー
ELF						
4800 NPR70	FULL FLATLOW					
		95. 3 ~ 97. 3	HN-288	FN-4451		FN-4466
NKR81E	1.75t LOW FLOOR	SINGLE TIRE	02. 4 ~ 04. 5	HN-384		※ FN-4443
	2t HIGH FLOOR LONG, INDEPENDENT SUSPENSION	DOUBLE TIRE	02. 4 ~ 04. 5	HN-384	FN-4459	※ FN-4443
	2t HIGH FLOOR LONG, W/O INDEPENDENT SUSPENSION	DOUBLE TIRE	02. 4 ~ 04. 5	HN-464		※ FN-4443
	DUSTCART, VACUUM, CRANE		02. 4 ~ 04. 5	HN-464		※ FN-4443
	W/O THE ABOVE		02. 4 ~ 04. 5	HN-489		※ FN-4443
※REAR DRUM FN-4451orFN-4459orFN-4461						
NKR81E3N	2t HIGH FLOOR LONG, INDEPENDENT SUSPENSION	DOUBLE TIRE	02. 4 ~ 04. 5	HN-384		※ FN-4443
	2t HIGH FLOOR LONG, W/O INDEPENDENT SUSPENSION	DOUBLE TIRE	02. 4 ~ 04. 5	HN-464		※ FN-4443
	W/O THE ABOVE		02. 4 ~ 04. 5	HN-489		※ FN-4443
※REAR DRUM FN-4451orFN-4459orFN-4461						
NKR81EA,EAV	1.75t LOW FLOOR	SINGLE TIRE	02. 4 ~ 04. 5	HN-384		※ FN-4443
	2t HIGH FLOOR LONG, INDEPENDENT SUSPENSION	SINGLE TIRE	02. 4 ~ 04. 5	HN-384	FN-4459	※ FN-4443
	2t FULL FALFLOW, INDEPENDENT SUSPENSION	DOUBLE TIRE	02. 4 ~ 04. 5	HN-384		※ FN-4443
	2t HIGH FLOOR LONG, W/O INDEPENDENT SUSPENSION	DOUBLE TIRE	02. 4 ~ 04. 5	HN-464		※ FN-4443
	DRYVAN, W/O INDEPENDENT SUSPENSION		02. 4 ~ 04. 5	HN-464		※ FN-4443
	W/O THE ABOVE		02. 4 ~ 04. 5	HN-489		※ FN-4443
※REAR DRUM FN-4451orFN-4459orFN-4461						
NKR81ED	2t HIGH FLOOR LONG, INDEPENDENT SUSPENSION		02. 5 ~ 04. 5	HN-384	FN-4459	※ FN-4443
	2t HIGH FLOOR LONG, W/O INDEPENDENT SUSPENSION		02. 5 ~ 04. 5	HN-464		※ FN-4443
	2t HIGH FLOOR LONG, W/O THE ABOVE		02. 5 ~ 04. 5	HN-489		※ FN-4443
※REAR DRUM FN-4451orFN-4459orFN-4461						
NKR81EN	3t HIGH FLOOR LONG, INDEPENDENT SUSPENSION	DOUBLE TIRE	02. 5 ~ 04. 5	HN-384	FN-4459	FN-4459 FN-4443
	3t HIGH FLOOR LONG, W/O INDEPENDENT SUSPENSION	DOUBLE TIRE	02. 5 ~ 04. 5	HN-464		FN-4459 FN-4443
NKR81EP	2t HIGH FLOOR LONG, INDEPENDENT SUSPENSION	DOUBLE TIRE	02. 5 ~ 04. 5	HN-384	FN-4459	※ FN-4443
	2t HIGH FLOOR LONG, W/O INDEPENDENT SUSPENSION	DOUBLE TIRE	02. 5 ~ 04. 5	HN-464		※ FN-4443
	W/O THE ABOVE		02. 5 ~ 04. 5	HN-489		※ FN-4443
※REAR DRUM FN-4451orFN-4459orFN-4461						
NKR81GAV	2t FULL FALFLOW, INDEPENDENT SUSPENSION		02. 5 ~ 04. 5	HN-384	FN-4459	※ FN-4443
	2t FULL FALFLOW, W/O INDEPENDENT SUSPENSION		02. 5 ~ 04. 5	HN-464		※ FN-4443
※REAR DRUM FN-4451orFN-4459orFN-4461						
NKR81GN	2t HIGH FLOOR LONG, INDEPENDENT SUSPENSION	DOUBLE TIRE	02. 5 ~ 04. 5	HN-384	FN-4459	※ FN-4443
	2t HIGH FLOOR LONG, W/O INDEPENDENT SUSPENSION	DOUBLE TIRE	02. 5 ~ 04. 5	HN-464		※ FN-4443
	3t HIGH FLOOR LONG	DOUBLE TIRE	02. 5 ~ 04. 5	HN-464		※ FN-4443
※REAR DRUM FN-4451orFN-4459orFN-4461						
NKR81LA	2t HIGH FLOOR, INDEPENDENT SUSPENSION	DOUBLE TIRE	02. 5 ~ 04. 5	HN-384	FN-4459	※ FN-4443
	2t HIGH FLOOR, W/O INDEPENDENT SUSPENSION	DOUBLE TIRE	02. 5 ~ 04. 5	HN-464		※ FN-4443
	W/O THE ABOVE		02. 5 ~ 04. 5	HN-489		※ FN-4443
※REAR DRUM FN-4451orFN-4459orFN-4465						
NKR81LN			02. 5 ~ 04. 5	HN-384	FN-4459	FN-4459 FN-4443
NKR81LR	2t HIGH FLOOR, INDEPENDENT SUSPENSION		02. 5 ~ 04. 5	HN-384	FN-4459	※ FN-4443
	2t HIGH FLOOR, W/O INDEPENDENT SUSPENSION	DOUBLE TIRE	02. 5 ~ 04. 5	HN-464		※ FN-4443
	W/O THE ABOVE		02. 5 ~ 04. 5	HN-489		※ FN-4443
※REAR DRUM FN-4451orFN-4459						
NKR81LV	3t HIGH FLOOR LONG, INDEPENDENT SUSPENSION	DOUBLE TIRE	02. 4 ~ 04. 5	HN-384	FN-4459	FN-4459 FN-4443
	3t HIGH FLOOR LONG, W/O INDEPENDENT SUSPENSION	DOUBLE TIRE	02. 4 ~ 04. 5	HN-464		FN-4459 FN-4443
	DRYVAN		02. 4 ~ 04. 5	HN-464		FN-4459 FN-4443
NKR81A	1.75t, 2t		04. 5 ~ 06.12	HN-543		FN-4461 FN-4443
	1.75t, 2t FLATLOW DOUBLE TIRE, W/ ABS		04. 5 ~ 06.12	HN-543		※ FN-4443

ISUZU - 7

Model 車種形式	Year 年式	Front フロント		Rear リア		Parking パーキング
		Pad パッド	Shoe シュー	Pad パッド	Shoe シュー	Shoe シュー
ELF						
4800 NKR81A	1.75t,2t FLATLOW DOUBLE TIRE, W/O ABS	04. 5 ~ 06.12	HN-464			※ FN-4443
	2t HIGH FLOOR DOUBLE TIRE	04. 5 ~ 06.12	HN-464	FN-4459		※ FN-4443
	2t HIGH FLOOR DUSTCART, W/O PTO FLYWHEEL DOUBLE TIRE	04. 5 ~ 06.12	HN-543			※ FN-4443
	2.95t,3t HIGH FLOOR DOUBLE TIRE	04. 5 ~ 06.12	HN-464	FN-4459		※ FN-4443
	2.95t,3t FULL FLATLOW DOUBLE TIRE	04. 5 ~ 06.12	HN-464	FN-4459		※ FN-4443
	2t FULL FLATLOW DOUBLE TIRE	04. 5 ~ 06.12	HN-464			※ FN-4443
	2t FULL FLATLOW, W/O DUMP TRUCK DOUBLE TIRE, W/ ABS	04. 5 ~ 06.12	HN-543			※ FN-4443
※REAR DRUM FN-4451orFN-4459orFN-4465						
NKR81AD	2t HIGH FLOOR DOUBLE TIRE	04. 5 ~ 06.12	HN-464	FN-4459		※ FN-4443
	2t HIGH FLOOR DUSTCART, W/O PTO FLYWHEEL DOUBLE TIRE	04. 5 ~ 06.12	HN-543			※ FN-4443
	2t FULL FLATLOW DOUBLE TIRE	04. 5 ~ 06.12	HN-464			※ FN-4443
	2t FULL FLATLOW, W/O DUMP TRUCK DOUBLE TIRE, W/ ABS	04. 5 ~ 06.12	HN-543			※ FN-4443
※REAR DRUM FN-4451orFN-4459						
NKR81AN	1.75t FLATLOW DOUBLE TIRE	04. 5 ~ 06.12	HN-464			※ FN-4443
	1.75t FLATLOW, W/O DUMP TRUCK DOUBLE TIRE, W/ ABS	04. 5 ~ 06.12	HN-543			※ FN-4443
	2t FLATLOW DOUBLE TIRE	04. 5 ~ 06.12	HN-543			※ FN-4443
	2t,3t HIGH FLOOR DOUBLE TIRE	04. 5 ~ 06.12	HN-464	FN-4459		※ FN-4443
	2t,3t HIGH FLOOR, W/O PTO FLYWHEEL DOUBLE TIRE	04. 5 ~ 06.12	HN-543			※ FN-4443
※REAR DRUM FN-4451orFN-4459orFN-4461						
NKR81AR	2t FLATLOW DOUBLE TIRE, W/ ABS	04. 5 ~ 06.12	HN-543			※ FN-4443
	2t FLATLOW DOUBLE TIRE, W/O ABS	04. 5 ~ 06.12	HN-464			※ FN-4443
	2t HIGH FLOOR DOUBLE TIRE	04. 5 ~ 06.12	HN-464	FN-4459		※ FN-4443
※REAR DRUM FN-4451orFN-4459orFN-4465						
NKR81N	2t,3t HIGH FLOOR DOUBLE TIRE	04. 5 ~ 06.12	HN-464	FN-4459		※ FN-4443
	2t,3t HIGH FLOOR DUSTCART, W/O PTO FLYWHEEL DOUBLE TIRE	04. 5 ~ 06.12	HN-543			※ FN-4443
※REAR DRUM FN-4451orFN-4459						
NKR81R	4t HIGH FLOOR DOUBLE TIRE	04. 5 ~ 06.12	HN-464	FN-4459		FN-4459 FN-4443
NKS81	INDEPENDENT SUSPENSION	02. 6 ~ 06.12	HN-384			FN-4451 FN-4443
	W/O INDEPENDENT SUSPENSION	02. 6 ~ 04. 5	HN-384	FN-4451		FN-4459 FN-4443
NPR81GR, GV	2t HIGH FLOOR, INDEPENDENT SUSPENSION	02. 5 ~ 04. 5	HN-489	FN-4459		※ FN-4443
	3t HIGH FLOOR, W/O INDEPENDENT SUSPENSION	02. 5 ~ 04. 5	HN-464			※ FN-4443
※REAR DRUM FN-4447orFN-4451orFN-4459						
NPR81LAR, LAV	2t HIGH FLOOR, INDEPENDENT SUSPENSION	02. 5 ~ 04. 5	HN-489	FN-4459		※ FN-4443
	2t HIGH FLOOR, W/O INDEPENDENT SUSPENSION	02. 5 ~ 04. 5	HN-464			※ FN-4443
	2t LOW FLOOR	02. 5 ~ 04. 5	HN-464			※ FN-4443
※REAR DRUM FN-4447orFN-4451orFN-4459						
NPR81LR, LV	2t,3t LOW FLOOR, INDEPENDENT SUSPENSION	02. 5 ~ 04. 5	HN-489	FN-4459		※ FN-4443
	2t,3t LOW FLOOR, W/O INDEPENDENT SUSPENSION	02. 5 ~ 04. 5	HN-464			※ FN-4443
	2t HIGH FLOOR LONG DOUBLE TIRE	02. 5 ~ 04. 5	HN-489			※ FN-4443
	2.75t HIGH FLOOR LONG DOUBLE TIRE	02. 5 ~ 04. 5	HN-464			※ FN-4443
	3.5t HIGH FLOOR, INDEPENDENT SUSPENSION	02. 5 ~ 04. 5	HN-491			※ FN-4443
※REAR DRUM FN-4447orFN-4451orFN-4459						
NPR81LZ	3.5t HIGH FLOOR	02. 5 ~ 04. 5	HN-491	FN-4459		FN-4459 FN-4443
NPR81PAR, PAV	2t HIGH FLOOR, INDEPENDENT SUSPENSION	02. 5 ~ 04. 5	HN-489	FN-4459		※ FN-4443
	2t HIGH FLOOR, W/O INDEPENDENT SUSPENSION	02. 5 ~ 04. 5	HN-464			※ FN-4443
	2t LOW FLOOR, INDEPENDENT SUSPENSION	02. 5 ~ 04. 5	HN-489			※ FN-4443
※REAR DRUM FN-4447orFN-4451orFN-4459						
NPR81PR, PV	2t HIGH FLOOR, INDEPENDENT SUSPENSION	02. 5 ~ 04. 5	HN-489	FN-4459		※ FN-4443
	2t HIGH FLOOR, W/O INDEPENDENT SUSPENSION	02. 5 ~ 04. 5	HN-464			※ FN-4443

- NISSAN
- TOYOTA (HINO)
- MAZDA
- ISUZU
- HONDA
- MITSUBISHI
- SUBARU
- SUZUKI
- DAIHATSU
- LEXUS
- INFINITY
- HYUNDAI
- KIA

ISUZU - 8

- NISSAN
- TOYOTA (HINO)
- MAZDA
- ISUZU**
- HONDA
- MITSUBISHI
- SUBARU
- SUZUKI
- DAIHATSU
- LEXUS
- INFINITI
- HYUNDAI
- KIA

Model 車種形式	Year 年式	Front フロント		Rear リア		Parking パーキング
		Pad パッド	Shoe シュー	Pad パッド	Shoe シュー	Shoe シュー
ELF						
4800 NPR81PR, PV	2.75t ULTRA HIGH FLOOR LONG	DOUBLE TIRE	02. 5 ~ 04. 5	HN-464		※ FN-4443
	3.5t HIGH FLOOR, INDEPENDENT SUSPENSION		02. 5 ~ 04. 5	HN-491		※ FN-4443
※REAR DRUM FN-4451orFN-4459						
NPR81DR	4t HIGH FLOOR	DOUBLE TIRE	04. 6 ~ 06.12	HN-464	FN-4459	FN-4443
NPR81N, R	2t HIGH FLOOR	DOUBLE TIRE	04. 6 ~ 06.12	HN-464		※ FN-4443
	3t HIGH FLOOR	DOUBLE TIRE	04. 6 ~ 06.12	HN-491	FN-4459	※ FN-4443
※REAR DRUM FN-4451orFN-4459						
NPR81AN, AR	2t HIGH FLOOR	DOUBLE TIRE	04. 6 ~ 06.12	HN-464		※ FN-4443
	3t HIGH FLOOR	DOUBLE TIRE	04. 6 ~ 06.12	HN-491	FN-4459	※ FN-4443
※REAR DRUM FN-4451orFN-4459						
NPS81AN	2t HIGH FLOOR	DOUBLE TIRE	04. 6 ~ 06.12	HN-464	FN-4451	FN-4443
	3.5t FULL FLATLOW	DOUBLE TIRE	04. 6 ~ 06.12	HN-491		FN-4443
NPS81AR	2t FULL FLATLOW	DOUBLE TIRE	04. 6 ~ 06.12	HN-464	FN-4451	FN-4443
	3.5t FULL FLATLOW	DOUBLE TIRE	04. 6 ~ 06.12	HN-491		FN-4443
NPS81N	3t HIGH FLOOR	DOUBLE TIRE	04. 6 ~ 06.12	HN-491	FN-4451	FN-4443
5000 NPR72GDR			97. 4 ~ 04. 5	HN-288	※	HN-464 ※ FN-4443
※FRONT DRUM FN-4451orFN-4459, REAR DRUM FN-4451orFN-4459						
NPR72GR	HIGH FLOOR		97. 4 ~ 04. 5	HN-288	※	HN-464 ※ FN-4443
	3t HIGH FLOOR		97. 4 ~ 04. 5	HN-464	※	HN-464 ※ FN-4443
※FRONT DRUM FN-4451orFN-4459, REAR DRUM FN-4447orFN-4451orFN-4459						
NPR72GY			98. 1 ~ 04. 5	HN-288	※	HN-464 ※ FN-4443
※FRONT DRUM FN-4451orFN-4459, REAR DRUM FN-4451orFN-4459						
NPR72LR, LV	HIGH FLOOR, INDEPENDENT SUSPENSION		97. 4 ~ 04. 5	HN-489	※	※ ※ FN-4443
	HIGH FLOOR, W/O INDEPENDENT SUSPENSION		97. 4 ~ 04. 5	HN-464	※	※ ※ FN-4443
	3t HIGH FLOOR		97. 4 ~ 04. 5	HN-464	※	※ ※ FN-4443
	3.5t HIGH FLOOR		97. 4 ~ 04. 5	HN-491	※	※ ※ FN-4443
※FRONT DRUM FN-4451orFN-4459, REAR DRUM FN-4447orFN-4451orFN-4459, REAR DISC HN-464						
NPR72PR, PV	HIGH FLOOR, INDEPENDENT SUSPENSION		97. 4 ~ 04. 5	HN-489	※	※ ※ FN-4443
	HIGH FLOOR, W/O INDEPENDENT SUSPENSION		97. 4 ~ 04. 5	HN-464	※	※ ※ FN-4443
	3t HIGH FLOOR		97. 4 ~ 04. 5	HN-464	※	※ ※ FN-4443
	3.5t HIGH FLOOR		97. 4 ~ 04. 5	HN-491	※	※ ※ FN-4443
※FRONT DRUM FN-4451orFN-4459, REAR DRUM FN-4447orFN-4451orFN-4459, REAR DISC HN-464						
NPR72LAR, LAV	2t HIGH FLOOR, INDEPENDENT SUSPENSION		99. 8 ~ 04. 5		※	※ ※ FN-4443
	2t HIGH FLOOR, W/O INDEPENDENT SUSPENSION		99. 8 ~ 04. 5		※	※ ※ FN-4443
	3.5t HIGH FLOOR		99. 8 ~ 04. 5		※	※ ※ FN-4443
※FRONT DRUM FN-4459, REAR DRUM FN-4447orFN-4451orFN-4459, REAR DISC HN-464						
NPR72GV	3t HIGH FLOOR	DOUBLE TIRE	00.12 ~ 04. 5	HN-464	FN-4459	※ FN-4443
※REAR DRUM FN-4447orFN-4451orFN-4459						
NPR72LYR, PYR			00.12 ~ 04. 5	HN-464	FN-4459	HN-464 ※ FN-4443
※REAR DRUM FN-4451orFN-4459						
NPR72PAR, PAV	HIGH FLOOR, INDEPENDENT SUSPENSION		99. 8 ~ 04. 5	HN-489	※	※ ※ FN-4443
	HIGH FLOOR, W/O INDEPENDENT SUSPENSION		99. 8 ~ 04. 5	HN-464	※	※ ※ FN-4443
	3.5t HIGH FLOOR		99. 8 ~ 04. 5	HN-491	※	※ ※ FN-4443
※FRONT DRUM FN-4459, REAR DRUM FN-4447orFN-4451orFN-4459, REAR DISC HN-464						
NPR72GN	4t HIGH FLOOR		02. 5 ~ 04. 5		FN-4459	FN-4443
NPR72LZ	3.5t HIGH FLOOR		02. 5 ~ 04. 5	HN-491	FN-4459	FN-4443
NPS72GN	3.5t HIGH FLOOR, DUMP		97. 4 ~ 04. 5		FN-4451	FN-4443
NPS72LN	2t HIGH FLOOR		02.10 ~ 04. 5	HN-489	※	※ FN-4443

ISUZU - 9

Model 車種形式	Year 年式	Front フロント		Rear リア		Parking パーキング
		Pad パッド	Shoe シュー	Pad パッド	Shoe シュー	Shoe シュー
ELF						
5000 NPS72LN	2t HIGH FLOOR, FULL FLATLOW	02.10 ~ 04. 5	HN-464	※		FN-4443
	3.5t HIGH FLOOR	02.10 ~ 04. 5	HN-491	※		FN-4443
※FRONT DRUM FN-4451, REAR DRUM FN-4451orFN4459						
NPS72LA, PA	6EXA, 6EXY, FLATLOW	02.10 ~ 04. 5	HN-464	FN-4451		FN-4443
	6EXA, 6EXY, W/O FLATLOW	02.10 ~ 04. 5	HN-489	FN-4451		FN-4443
	6JXA, 6JXY	02.10 ~ 04. 5	HN-464	FN-4451		FN-4443
	6LXA5, 6LXY5	02.10 ~ 04. 5	HN-491	FN-4451		FN-4443
※REAR DRUM FN-4447orFN-4451orFN4459						
NPS72LAV	FULL FLATLOW	02.10 ~ 04. 5	HN-491	FN-4451		FN-4443
NKR72	2t HIGH FLOOR	00. 2 ~ 04. 5	HN-384	※		FN-4443
	2t HIGH FLOOR, INDEPENDENT SUSPENSION	00. 2 ~ 04. 5	HN-489	※		FN-4443
	2t HIGH FLOOR, W/O INDEPENDENT SUSPENSION	00. 2 ~ 04. 5	HN-464	※		FN-4443
※FRONT DRUM FN-4459, REAR DRUM FN-4451orFN4459orFN-4461						
5200 NPR75GDR		99. 4 ~ 04. 5	HN-464	FN-4459	HN-464	FN-4466
※REAR DRUM FN-4451orFN-4459						
NPR75LR, LV	HIGH FLOOR, INDEPENDENT SUSPENSION, W/O CRANE	99. 4 ~ 04. 5	HN-489	※	※	FN-4466
	HIGH FLOOR, W/O INDEPENDENT SUSPENSION	99. 4 ~ 04. 5	HN-464	※	※	FN-4466
	3.5t HIGH FLOOR, INDEPENDENT SUSPENSION	99. 4 ~ 04. 5	HN-491	※	※	FN-4466
	3t HIGH FLOOR	99. 4 ~ 04. 5	HN-464	※	※	FN-4466
※FRONT DRUM FN-4459, REAR DRUM FN-4447orFN-4451orFN-4459, REAR DISC HN-464						
NPR75LYR, PYR	HIGH FLOOR	99. 4 ~ 04. 5	HN-464	FN-4459	HN-464	FN-4466
※REAR DRUM FN-4451orFN-4459						
NPR75PR, PV	HIGH FLOOR, INDEPENDENT SUSPENSION, W/O CRANE	99. 4 ~ 04. 5	HN-489	※	※	FN-4466
	HIGH FLOOR, W/O INDEPENDENT SUSPENSION HIGH FLOOR	99. 4 ~ 04. 5	HN-464	※	※	FN-4466
	3.5t HIGH FLOOR, INDEPENDENT SUSPENSION	99. 4 ~ 04. 5	HN-491	※	※	FN-4466
	3t HIGH FLOOR	99. 4 ~ 04. 5	HN-464	※	※	FN-4466
※FRONT DRUM FN-4459, REAR DRUM FN-4447orFN-4451orFN-4459, REAR DISC HN-464						
NPR75N	4t HIGH FLOOR, HYDRO ASSIST BRAKE	DOUBLE TIRE	06.12 ~	HN-491	FN-4459	FN-4443
	4t HIGH FLOOR, W/O HYDRO ASSIST BRAKE	DOUBLE TIRE	06.12 ~	HN-464	FN-4459	FN-4443
COMO						
2000 JVPE25		01. 5 ~ 07. 8	HN-475			FN-1174
JVRE25		07. 9 ~ 12. 6	HN-475			FN-1174
JQE25		03. 5 ~ 07. 8	HN-475			FN-1174
JQGE25		01.11 ~ 07. 8	HN-475			FN-1174
JDQGE25		01. 5 ~ 07. 8	HN-475			FN-1174
2400 JCQGE25		01. 5 ~ 07. 8	HN-475			FN-1174
2500 JSE25		07. 9 ~ 12. 6	HN-475			FN-1174
JSGE25		07. 9 ~ 12. 6	HN-475			FN-1174
JCSGE25		07. 9 ~ 12. 6	HN-475			FN-1174
JDSGE25		07. 9 ~ 12. 6	HN-475			FN-1174
3000 JCWGE25		01. 5 ~ 09. 9	HN-475			FN-1174
JCWMGE25		01. 5 ~ 09. 9	HN-475			FN-1174
JDWGE25		01. 5 ~ 09. 9	HN-475			FN-1174
JDWMGE25		01. 5 ~ 09. 9	HN-475			FN-1174

- NISSAN
- TOYOTA (HINO)
- MAZDA
- ISUZU**
- HONDA
- MITSUBISHI
- SUBARU
- SUZUKI
- DAIHATSU
- LEXUS
- INFINITY
- HYUNDAI
- KIA

ISUZU - 10

Double-lined items are discontinued.

- NISSAN
- TOYOTA
(HINO)
- MAZDA
- ISUZU**
- HONDA
- MITSUBISHI
- SUBARU
- SUZUKI
- DAIHATSU
- LEXUS
- INFINITI
- HYUNDAI
- KIA

Model 車種形式	Year 年式	Front フロント		Rear リア		Parking パーキング
		Pad パッド	Shoe シュー	Pad パッド	Shoe シュー	Shoe シュー
COMO						
3000 JVWE25	01. 5 ~ 09. 9	HN-475			FN-1174	
JVWME25	01. 5 ~ 09. 9	HN-475			FN-1174	
GEMINI						
1500 JT151F	90. 2 ~ 93. 9	HN-257		HN-296	FN-4455	
MJ3 C/C	95. 2 ~ 98. 3	HN-265			FN-5518	
MJ4 W/O ABS	97. 1 ~ 00. 6	HN-265			FN-5518	
W/ ABS	97. 1 ~ 00. 6	HN-265			FN-5520	
1600 JT191						
MJ1 C/C	93. 9 ~ 98. 3	HN-265			FN-5518	
W/O ABS	93. 9 ~ 98. 3	HN-265		HN-266	FN-5518	
G/G MT	93. 9 ~ 98. 3	HN-265			FN-5520	
G/G AT	93. 9 ~ 98. 3	HN-265			FN-5520	
G/G	93. 9 ~ 98. 3	HN-264		HN-266		
MJ2 C/C	93. 9 ~ 98. 3	HN-265			FN-5520	
C/C	93. 9 ~ 98. 3	HN-264			FN-5520	
MJ5 MT	97. 1 ~ 00. 6	HN-265			FN-5518	
W/ ABS	97. 1 ~ 00. 6	HN-265			FN-5520	
MJ6	97. 1 ~ 00. 6	HN-264			FN-5520	
1700 JT641	90. 2 ~ 93. 9	HN-257		HN-296	FN-4455	
GEMINET						
1600 AP8	2WD 88. 9 ~ 94. 3	HN-153			FN-7729	
AP9	4WD 88. 9 ~ 94. 3	HN-153			FN-7730	
D-MAX						
2500	2WD 02. ~	HN-708			FN-4495	
3000	4WD 02. ~	HN-708			FN-4496	
BEGIN						
3000 VFR69F	PICK TRUCK 01. 5 ~	HN-258				
VehiCROSS						
3200 UGS25DW	97. 3 ~ 99. 2	HN-258		HN-299		
PIAZZA						
1800 JT221	91. 7 ~ 93. 9	HN-257		HN-296		
2000 JR120, JR130	84. 6 ~ 90. 6	HN-150				
BIGHORN						
2600 UBS17	88.11 ~ 91.12	HN-196		HN-197		
2700 UBS55	87.10 ~ 91.12	HN-196		HN-197		
3000 UBS73DW	SHORT BODY 98. 2 ~ 01. 7	HN-258		HN-299		
UBS73GW	LONG BODY 98. 2 ~ 02. 7	HN-258		HN-299		

ISUZU - 11

Model 車種形式	Year 年式	Front フロント		Rear リア		Parking パーキング
		Pad パッド	Shoe シュー	Pad パッド	Shoe シュー	Shoe シュー
BIGHORN						
3100 UBS69	91.12 ~ 98. 2	HN-258		HN-299		
3200 UBS25	91.12 ~ 98. 2	HN-258		HN-299		
3500 UBS26DW SHORT BODY	98. 2 ~ 01. 7	HN-258		HN-299		
UBS26GW LONG BODY	98. 2 ~	HN-258		HN-299		
FARGO						
2000 NFR12, WFR12	85.12 ~ 95. 8	HN-083			FN-4431	
JVTGE24	96. 8 ~ 99. 6	HN-137			FN-1174	
JCPGE24	99. 6 ~ 01. 5	HN-531			FN-1189	
JVPE24	99. 6 ~ 01. 5	HN-531			FN-1189	
JVPGE24	99. 6 ~ 01. 5	HN-531			FN-1189	
2400 NFR62, NFS62	88. 8 ~ 94. 6	HN-083			FN-4431	
WFR62, WFS62	87.10 ~ 95. 8	HN-083			FN-4431	
JCQGE24	99. 6 ~ 01. 5	HN-531			FN-1189	
2700 JCRGE24	95. 8 ~ 97. 5	HN-137			FN-1174	
JCRMGE24	96. 8 ~ 97. 5	HN-137			FN-1174	
JVRE24	95. 8 ~ 97. 5	HN-137			FN-1174	
JVRGE24	95. 8 ~ 97. 5	HN-137			FN-1174	
JVRME24	96. 8 ~ 97. 5	HN-137			FN-1174	
JVRMGE24	95. 8 ~ 97. 5	HN-137			FN-1174	
JARE24	95. 8 ~ 97. 5	HN-137			FN-1174	
JARME24	95. 8 ~ 97. 5	HN-137			FN-1174	
JKRGE24	95. 8 ~ 99. 6	HN-137			FN-1174	
JKRMGE24	95. 8 ~ 99. 6	HN-137			FN-1174	
JDRGE24 MICROBUS	96. 8 ~ 97. 5	HN-137			FN-1174	
JDRMGE24 MICROBUS	96. 8 ~ 97. 5	HN-137			FN-1174	
3000 JFEGE24 AMBULANCE	95. 8 ~ 99. 6	HN-137			FN-1174	
JCEGE24 AMBULANCE	99. 6 ~ 01. 5	HN-137			FN-1174	
3200 JCWGE24	96. 8 ~ 99. 6	HN-137			FN-1174	
	99. 6 ~ 01. 5	HN-531			FN-1189	
JCWMGE24	97. 5 ~ 99. 6	HN-137			FN-1174	
	99. 6 ~ 01. 5	HN-531			FN-1189	
JCWBE24	97. 5 ~ 99. 6	HN-137			FN-1174	
JCWMBE24	97. 5 ~ 99. 6	HN-137			FN-1174	
JVWE24	96. 8 ~ 99. 6	HN-137			FN-1174	
	99. 6 ~ 01. 5	HN-531			FN-1189	
JVWME24	97. 5 ~ 99. 6	HN-137			FN-1174	
	99. 6 ~ 01. 5	HN-531			FN-1189	
JVWGE24	96. 8 ~ 99. 6	HN-137			FN-1174	
	99. 6 ~ 01. 5	HN-531			FN-1189	
JVWMGE24	96. 8 ~ 99. 6	HN-137			FN-1174	
	99. 6 ~ 01. 5	HN-531			FN-1189	
JDWGE24 MICROBUS	97. 5 ~ 01. 5	HN-137			FN-1174	

- NISSAN
- TOYOTA (HINO)
- MAZDA
- ISUZU**
- HONDA
- MITSUBISHI
- SUBARU
- SUZUKI
- DAIHATSU
- LEXUS
- INFINITY
- HYUNDAI
- KIA

ISUZU - 12

NISSAN

TOYOTA
(HINO)

MAZDA

ISUZU

HONDA

MITSUBISHI

SUBARU

SUZUKI

DAIHATSU

LEXUS

INFINITI

HYUNDAI

KIA

Model 車種形式	Year 年式	Front フロント		Rear リア		Parking パーキング
		Pad パッド	Shoe シュー	Pad パッド	Shoe シュー	Shoe シュー
FARGO						
3200 JDWMGE24 MICROBUS	99. 6 ~ 01. 5	HN-137			FN-1174	
FARGO FILLY						
3000 JATE50	99. 8 ~ 02. 3	HN-531			FN-1174	
JATWE50	99. 8 ~ 02. 3	HN-531			FN-1174	
3200 JAVE50	97. 7 ~ 99. 8	HN-531			FN-1174	
JAVWE50	97. 7 ~ 99. 8	HN-531			FN-1174	
3300 JALE50	98.10 ~ 02. 3	HN-531			FN-1174	
JALWE50	98.10 ~ 02. 3	HN-531			FN-1174	
FASTER						
2800 TFR55	89.11 ~ 93.12	HN-196			FN-4452	
Mu·WIZARD						
2600 UCS17	89. 4 ~ 93.10	HN-196		HN-197		
2800 UCS55	90. 7 ~ 93. 7	HN-196		HN-197		
	93. 8 ~ 93.10	HN-258		HN-299		
3000 UES73	98. 5 ~ 01. 7	HN-258		HN-299		
3100 UCS69	93.10 ~ 98. 7	HN-258		HN-299		
3200 UES25EW	00. 5 ~	HN-258		HN-299		
	UES25FW	98. 3 ~ 02. 9	HN-258	HN-299		
	UER25FW	99. 2 ~ 02. 9	HN-258		FN-4462	

HONDA - 1

- NISSAN
- TOYOTA
(HINO)
- MAZDA
- ISUZU
- HONDA**
- MITSUBISHI
- SUBARU
- SUZUKI
- DAIHATSU
- LEXUS
- INFINITI
- HYUNDAI
- KIA

Model 車種形式	Year 年式	Front フロント		Rear リア		Parking パーキング
		Pad パッド	Shoe シュー	Pad パッド	Shoe シュー	Shoe シュー
CR-V						
2000 RD1 AT	95.10 ~ 01.8	HN-484			FN-5524	
MT	97.9 ~ 01.8	HN-254			FN-5524	
RD2 AT	98.12 ~ 01.8	HN-484			FN-5524	
MT	98.12 ~ 01.8	HN-254			FN-5524	
RD4	01.8 ~ 04.9	HN-484		HN-580		
RD5 4WD 141NT CALIPER MT	01.8 ~ 04.9	HN-484		HN-580		
AT	01.8 ~ 04.9	HN-485		HN-580		
RM1	11.12 ~			HN-580		
2400 RD6, RD7	04.9 ~ 06.10	HN-485		HN-580		
RE3, RE4	06.10 ~ 11.12	HN-559		HN-580		
RM4	11.12 ~ 16.3			HN-580		
CR-X						
1500 EF6	87.9 ~ 92.2	HN-090			FN-5518	
EG1 W/O ABS	92.2 ~ 95.9	HN-265			FN-5527	
W/ ABS	92.2 ~ 95.9	HN-264		HN-266		
1600 EG2	92.2 ~ 97.7	HN-264		HN-266		
EJ4	95.9 ~ 97.7	HN-265			FN-5518	
CR-Z						
1500 ZF1	10.2 ~	HN-560		HN-397		
ZF2	12.9 ~ 15.9	HN-560		HN-397		
ZF2	15.9 ~	HN-485				
HR-V						
1600 GH1 2DOORS	98.9 ~ 03.10	HN-254			FN-5520	
GH2 2DOORS 4WD	98.9 ~ 03.10	HN-254			FN-5520	
GH3 4DOORS	99.7 ~ 05.9	HN-254			FN-5524	
GH4 4DOORS 4WD	99.7 ~ 05.9	HN-254			FN-5524	
MDX						
3500 YD1	03.3 ~ 06.6	HN-531				
NSX						
3000 NA1	90.8 ~ 05.12	HN-254				
3200 NA2	97.2 ~ 05.12	HN-254				
S2000						
2000 AP1	99.4 ~ 05.11			HN-397		
2200 AP2	05.11 ~			HN-397		
S-MX						
2000 RH1, RH2	96.11 ~ 02.1	HN-254			FN-5524	

HONDA - 2

Model 車種形式	Year 年式	Front フロント		Rear リア		Parking パーキング
		Pad パッド	Shoe シュー	Pad パッド	Shoe シュー	Shoe シュー
Z						
660 PA1	98.10 ~ 02.1	HN-436			FN-5524	
AVANCIER						
2300 TA1	99.9 ~ 03.6	HN-254		HN-255		
TA2 4WD	99.9 ~ 03.6	HN-445		HN-255		
3000 TA3	99.9 ~ 03.6	HN-254		HN-255		
TA4 4WD	00.2 ~ 03.6	HN-445		HN-255		
ACTY						
660 HH3, HH4	90.2 ~ 99.6	HN-278			FN-5520	
HA5 CRAWLER	95.12 ~ 99.5	HN-278			FN-5520	
HA6, HA7	99.5 ~ 09.12	HN-336			FN-5520	
HA8, HA9	09.12 ~	HN-336			FN-5520	
	15.3 ~				FN-5520	
ACTY VAN						
660 HH5, 6	99.6 ~	HN-336			FN-5520	
ACCORD						
1800 CB1	89.9 ~ 93.9	HN-223		HN-397	FN-5520	
CB2	89.9 ~ 91.7	HN-223		HN-397		
CD3 W/O ABS	93.9 ~ 97.9	HN-223			FN-5520	
W/ ABS	93.9 ~ 97.9	HN-223		HN-397		
CF3	97.8 ~ 02.10	HN-423		HN-397		
2000 CB3	89.9 ~ 93.9	HN-223		HN-397	FN-5520	
CB4	89.9 ~ 93.9	HN-223		HN-397		
CD4 W/O ABS	93.9 ~ 97.9	HN-223			FN-5520	
W/ ABS	93.9 ~ 97.9	HN-223		HN-397		
CF4, CF5	97.8 ~ 02.10	HN-254		HN-397		
CL3	00.6 ~ 02.10	HN-254		HN-397		
CL7 20E, 20EL	02.10 ~ 08.12	HN-465		HN-397		
EURO-R	02.10 ~ 08.12	HN-445		HN-397		
20A	04.10 ~ 08.12	HN-509		HN-397		
CL8 20E, 20EL	02.10 ~ 08.12	HN-465		HN-397		
20A	04.10 ~ 08.12	HN-509		HN-397		
2200 CD5 W/O ABS	93.9 ~ 97.9	HN-223			FN-5520	
W/ ABS	93.9 ~ 97.9	HN-223		HN-397		
CD6	93.9 ~ 97.9	HN-254		HN-397		
CL1 EURO-R	00.6 ~ 02.10	HN-445		HN-397		
2400 CL9 24S	02.10 ~ 08.12	HN-445		HN-397		
CU2	08.12 ~ 11.2	HN-445				
CW2	08.12 ~ 11.2	HN-445		HN-255		
	11.2 ~ 13.6			HN-580		

- NISSAN
- TOYOTA (HINO)
- MAZDA
- ISUZU
- HONDA**
- MITSUBISHI
- SUBARU
- SUZUKI
- DAIHATSU
- LEXUS
- INFINITY
- HYUNDAI
- KIA

HONDA - 3

- NISSAN
- TOYOTA
(HINO)
- MAZDA
- ISUZU
- HONDA**
- MITSUBISHI
- SUBARU
- SUZUKI
- DAIHATSU
- LEXUS
- INFINITI
- HYUNDAI
- KIA

Model 車種形式	Year 年式	Front フロント		Rear リア		Parking パーキング
		Pad パッド	Shoe シュー	Pad パッド	Shoe シュー	Shoe シュー
ACCORD COUPE・WAGON						
2000 CB6	IMPORT	90. 4 ~ 94. 2	HN-223		HN-397	
CM1	~1100000	04.10 ~ 05.11	HN-465		HN-255	
	1100001~	05.11 ~	HN-509		HN-255	
2200 CB7, CB9	IMPORT	91. 4 ~ 94. 2	HN-223		HN-397	
CD7	IMPORT	94. 2 ~ 96.12	HN-374		HN-397	
CD8	IMPORT	94. 2 ~ 96.12	HN-254		HN-397	
CE1	IMPORT	94. 2 ~ 97. 9	HN-374		HN-397	
CF2	IMPORT	96. 8 ~ 97. 9	HN-254		HN-397	
2300 CF6	IMPORT	97.10 ~ 02.11	HN-254		HN-397	
CF7	IMPORT	97.10 ~ 02.11	HN-254		HN-397	
CH9	IMPORT	98.12 ~ 02.11	HN-254		HN-397	
CL2	IMPORT	00. 6 ~ 02.11	HN-254		HN-397	
2400 CM2, CM3	24T, TYPE S	02.11 ~ 05.11	HN-445		HN-255	
	24E	02.11 ~ 05.11	HN-465		HN-255	
	24EL	05.11 ~ 08.12	HN-509		HN-255	
ASCOT						
1800 CB1, CB2		89. 9 ~ 93.10	HN-223		HN-397	FN-5520
2000 CB3, CB4		89. 9 ~ 97. 9	HN-223		HN-397	FN-5520
CE4	W/O ABS	93.10 ~ 97. 9	HN-223			FN-5524
	W/ ABS	93.10 ~ 97. 9	HN-223		HN-397	
2300 CC4, CC5	INNOVA	92. 3 ~ 97. 9	HN-223		HN-397	
2500 CE5		93.10 ~ 97. 9	HN-254		HN-397	
INSIGHT						
1000 ZE1		99.11 ~ 06. 3				
1300 ZE2		09. 2 ~ 14. 2	HN-560			FN-5547
1500 ZE3		09. 2 ~ 14. 2	HN-560			FN-5547
INSPIRE・VIGOR・SABER						
2000 CB5		89.10 ~ 95. 2	HN-223		HN-397	FN-5524
CC3		92. 1 ~ 97. 2	HN-293		HN-397	
UA1		95. 2 ~ 98.10	HN-293		HN-397	
2500 CC2		92. 1 ~ 97. 2	HN-254		HN-397	
UA2		95. 2 ~ 98.10	HN-254		HN-397	
UA4		98.10 ~ 03. 6	HN-254		HN-255	
3000 UC1		03. 6 ~ 07.12	HN-445		HN-397	
3200 UA3		95. 6 ~ 98.10	HN-254		HN-397	

HONDA - 4

Model 車種形式	Year 年式	Front フロント		Rear リア		Parking パーキング
		Pad パッド	Shoe シュー	Pad パッド	Shoe シュー	Shoe シュー
INSPIRE・VIGOR・SABER						
UA5	98.10 ~ 03.6	HN-445		HN-255		
3500 CP3	07.12 ~ 12.9	HN-445		HN-604		
INTEGRA						
1600 DA5	89.4 ~ 91.10	HN-127		HN-206	FN-5519	
	W/O ABS 91.10 ~ 93.5	HN-127		HN-266		
	No. 1200001 ~ W/ ABS 91.10 ~ 93.5	HN-162		HN-266		
DA6	89.4 ~ 91.10	HN-162		HN-206		
DA7 ZXI	89.4 ~ 91.10	HN-127		HN-206	FN-5519	
	W/O ABS 91.10 ~ 93.7	HN-127		HN-266	FN-5519	
	No. 1200001 ~ W/ ABS 91.10 ~ 93.7	HN-162		HN-266	FN-5519	
DA8 XSI	89.4 ~ 91.10	HN-162		HN-206		
DC1	W/O ABS 93.5 ~ 00.9	HN-265			FN-5518	
	W/ ABS 93.5 ~ 00.9	HN-337		HN-266		
DB6	W/O ABS 93.7 ~ 00.9	HN-264			FN-5520	
	W/ ABS 93.7 ~ 00.9	HN-337		HN-266		
DB9 ZXI	93.7 ~ 00.9	HN-264			FN-5520	
1800 DB1 ESI	91.10 ~ 93.7	HN-162		HN-266		
DC2	93.5 ~ 00.9	HN-337		HN-266		
	TYPE R ~No. 1300000 95.10 ~ 98.1	HN-337		HN-266		
	No. 1300001 ~ 98.1 ~ 00.9	HN-254		HN-397		
DB7 ESi	93.7 ~ 95.9	HN-337		HN-266		
DB8	93.7 ~ 00.9	HN-337		HN-266		
	TYPE R ~No. 1300000 95.10 ~ 98.1	HN-337		HN-266		
	No. 1300001 ~ 98.1 ~ 00.9	HN-254		HN-397		
2000 DC5 IS	01.7 ~ 04.9	HN-264		HN-397		
	TYPE S 04.9 ~ 06.7	HN-423		HN-397		
	TYPE R 01.7 ~ 06.7			HN-397		
INTEGRA SJ						
1500 EK3	W/O ABS 96.2 ~ 00.8	HN-510			FN-5518	
	No. 5200001 ~ W/ ABS 96.2 ~ 00.8	HN-510			FN-5520	
AIRWAVE						
1500 GJ1, GJ2	05.4 ~ 10.8	HN-264			FN-5524	
EDIX						
1700 BE1	04.7 ~ 06.12	HN-264			FN-5524	
BE2 4WD	04.7 ~ 06.12	HN-465		HN-255		
2000 BE3	04.7 ~ 09.8	HN-465		HN-255		
BE4 4WD	04.7 ~ 09.8	HN-465		HN-255		
2400 BE8	06.12 ~ 09.8	HN-465		HN-255		
ELYSION						
2400 RR1, RR2	04.5 ~ 13.1	HN-531		HN-506		

NISSAN

TOYOTA
(HINO)

MAZDA

ISUZU

HONDA

MITSUBISHI

SUBARU

SUZUKI

DAIHATSU

LEXUS

INFINITY

HYUNDAI

KIA

HONDA - 5

- NISSAN
- TOYOTA
(HINO)
- MAZDA
- ISUZU
- HONDA**
- MITSUBISHI
- SUBARU
- SUZUKI
- DAIHATSU
- LEXUS
- INFINITI
- HYUNDAI
- KIA

Model 車種形式	Year 年式	Front フロント		Rear リア		Parking パーキング
		Pad パッド	Shoe シュー	Pad パッド	Shoe シュー	Shoe シュー
ELYSION						
3000 RR3, RR4	04. 5 ~ 13. 1	HN-531		HN-506		
3500 RR5, RR6	07. 1 ~ 13. 1	HN-531		HN-506		
SZ, AG	08.12 ~ 13. 1	HN-531				
ELEMENT						
2400 YH2	03. 4 ~ 05. 6	HN-485		HN-255		
ODYSSEY						
2200 RA1, RA2	94. 9 ~ 97. 9	HN-254		HN-255		
2300 RA3, RA4	97. 8 ~ 99.12	HN-254		HN-255		
RA6, RA7	99.12 ~ 03.10	HN-445		HN-255		
2400 RB1, RB2	ABSOLUTE 03.10 ~ 08.10	HN-445		HN-506		
	EXCL. ABSOLUTE 03.10 ~ 08.10	HN-509		HN-506		
RB3, RB4	ABSOLUTE 08.10 ~ 13.11	HN-445		HN-506		
	L I L, M 08.10 ~ 13.11	HN-509		HN-506		
RC1, RC2	13.11 ~			HN-580		
3000 RA5	PRESTAGE VG FF 97.10 ~ 00. 1	HN-254		HN-255		
RA8	00. 1 ~ 03.10	HN-445		HN-255		
RA9	4WD 00. 1 ~ 03.10	HN-445		HN-255		
ORTHIA						
1800 EL1	GX 96. 2 ~ 99. 6	HN-337			FN-5520	
2000 EL2	96. 2 ~ 02. 1	HN-337			FN-5520	
EL3	96. 2 ~ 02. 1	HN-337			FN-5520	
CAPA						
1500 GA4	98. 4 ~ 02. 1	HN-510			FN-5520	
GA6	4WD 99. 9 ~ 02. 1	HN-510			FN-5520	
CROSSROAD						
1800 RT1	18L 07. 2 ~ 10. 8	HN-509		HN-506		
	18L, X PACKAGE 17INCH 07. 2 ~ 10. 8	HN-445		HN-506		
RT2	18X 07. 2 ~ 10. 8	HN-445		HN-506		
2000 RT3, RT4	07. 2 ~ 10. 8	HN-445		HN-506		
THAT'S						
660 JD1	02. 2 ~ 07. 6	HN-336			FN-5529	
	TURBO 02. 2 ~ 07. 6				FN-5529	
JD2	02. 2 ~ 07. 6	HN-336			FN-5520	
	TURBO 4WD 02. 2 ~ 07. 6				FN-5520	
JEEP・CHEROKEE						
4000 7MX	91. 1 ~	HN-490				

HONDA - 6

Model 車種形式		Year 年式	Front フロント		Rear リア		Parking パーキング
			Pad パッド	Shoe シュー	Pad パッド	Shoe シュー	Shoe シュー
CIVIC							
1300	EF1		87. 9 ~ 92.10	HN-090			FN-5518
	EG3		91. 8 ~ 95. 9	HN-263			FN-5518
	EG7	MT	91. 8 ~ 95. 8	HN-263			FN-5518
		AT	91. 8 ~ 95. 8	HN-510			FN-5518
	EK2		W/O ABS	95. 8 ~ 00. 9	HN-263		FN-5518
			W/ ABS	95. 8 ~ 00. 9	HN-510		FN-5520
		EL MT		95. 8 ~ 00. 9	HN-263		FN-5518
		EL AT		95. 8 ~ 00. 9	HN-510		FN-5518
	EK2	EL27	W/ ABS	96. 9 ~ 00. 9	HN-510		FN-5520
	ES9	HYBRID		01.11 ~ 05. 5	HN-264		FN-5524
	FD3	HYBRID		05.11 ~ 10. 2	HN-264	HN-397	FN-5524
1500	EF2		87. 9 ~ 91. 8	HN-090		HN-266	FN-5518
	EG4	MX, ML	91. 8 ~ 95. 9	HN-263			FN-5518
		ETI MT	91. 8 ~ 95. 9	HN-263			FN-5518
		ETI AT	91. 8 ~ 95. 9	HN-265			FN-5518
		VTI	W/O ABS	91. 8 ~ 95. 9	HN-265		FN-5518
			W/ ABS	91. 8 ~ 95. 9	HN-264	HN-266	
	EG8	ETI, MX, ML MT	91. 8 ~ 95. 8	HN-263			FN-5518
			91. 8 ~ 95. 8	HN-265			FN-5518
		VTI	W/O ABS	91. 8 ~ 95. 8	HN-265		FN-5518
			W/ ABS	91. 8 ~ 95. 8	HN-264	HN-266	
	EK3	RI	W/O ABS	95. 8 ~ 00. 9	HN-263		FN-5518
			W/ ABS	95. 8 ~ 00. 9	HN-510		FN-5520
		VTI	W/O ABS	95. 8 ~ 00. 9	HN-510		FN-5518
			W/ ABS	95. 8 ~ 00. 9	HN-510		FN-5520
		FERIO Mi	W/O ABS	95. 8 ~ 00. 9	HN-510		FN-5518
			W/ ABS	95. 8 ~ 00. 9	HN-263		FN-5520
		FERIO VI, ML	95. 8 ~ 00. 9	HN-510			FN-5518
		FERIO VI-RS	98. 8 ~ 00. 9	HN-264		HN-266	
	EU1		00. 9 ~ 03. 9	HN-264			FN-5524
	EU2		00. 9 ~ 03. 9	HN-264			FN-5524
	ES1	FERIO IE, B	00. 9 ~ 05. 9	HN-510			FN-5520
	ES2	FERIO L4	00. 9 ~ 05. 9	HN-264			FN-5520
1600	EF3		87. 9 ~ 91. 8	HN-191		HN-206	
	EF5		87. 9 ~ 91. 8	HN-191			FN-5519
	EF9		87. 9 ~ 91. 8	HN-162		HN-206	
	EG5		W/O ABS	92. 5 ~ 95. 9	HN-265	HN-266	
			W/ ABS	92. 5 ~ 95. 9	HN-264	HN-266	
	EG6, EG9		91. 8 ~ 95. 9	HN-264		HN-266	
	EH1	RTX	91. 8 ~ 95. 8	HN-265			FN-5520
		RTSi	91. 8 ~ 95. 8	HN-264			FN-5520
	EJ3	EX1, EX14	93. 9 ~ 95. 8	HN-264			FN-5518
		EX13 AT	93. 9 ~ 95. 8	HN-264		HN-266	
	EJ1	COUPE	IMPORT	93. 2 ~ 96.12	HN-264		FN-5520
	EK4		95. 8 ~ 00. 9	HN-264		HN-266	
	EK5	FERIO RTI	95. 8 ~ 00. 9	HN-264			FN-5520
	EJ7	COUPE	IMPORT	96. 1 ~ 99. 2	HN-190		FN-5520

NISSAN

TOYOTA
(HINO)

MAZDA

ISUZU

HONDA

MITSUBISHI

SUBARU

SUZUKI

DAIHATSU

LEXUS

INFINITY

HYUNDAI

KIA

HONDA - 7

- NISSAN
- TOYOTA
(HINO)
- MAZDA
- ISUZU
- HONDA**
- MITSUBISHI
- SUBARU
- SUZUKI
- DAIHATSU
- LEXUS
- INFINITI
- HYUNDAI
- KIA

Model 車種形式	Year 年式	Front フロント		Rear リア		Parking パーキング
		Pad パッド	Shoe シュー	Pad パッド	Shoe シュー	Shoe シュー
CIVIC						
1600 EK8	FERIO LEV ~No.1100000		97.1 ~ 97.8	HN-510		FN-5518
	No.1100001~		97.8 ~ 98.8	HN-510		FN-5520
EK9	TYPE R		97.7 ~ 00.9	HN-254	HN-397	
1700 EU3			00.9 ~ 05.9	HN-264		FN-5524
EU4			00.9 ~ 05.9	HN-264		FN-5524
ES3			00.9 ~ 05.9	HN-264	HN-397	
EN1	GX		99.2 ~ 01.1	HN-190		FN-5520
EN2	GX		01.1 ~ 05.5	HN-484		FN-5520
ET2	FERIO X4		03.9 ~ 05.9	HN-264		FN-5520
1800 FD1			05.9 ~	HN-465	HN-397	
2000 EP3	TYPE R	IMPORT	01.12 ~ 05.9	HN-423	HN-397	
FD2			06.4 ~ 10.12	HN-465	HN-397	
	TYPE R BREMBO		07.3 ~ 10.12		HN-397	
CIVIC SHUTTLE						
1500 EF1			89.8 ~ 92.10	HN-090		FN-5519
EF2	25R		87.10 ~ 96.4	HN-091		FN-5519
	50XEXT		87.9 ~ 96.3	HN-263		FN-5519
1600 EF5			87.9 ~ 96.3	HN-191		FN-5519
CIVIC PRO						
1300 EY2			92.10 ~	HN-265		FN-5519
1500 EY4			92.10 ~	HN-265		FN-5519
1600 EY5			92.10 ~	HN-265		FN-5519
JAZZ						
3100 UCS69DWH			93.10 ~ 97.12	HN-258	HN-299	
STEPWAGON						
2000 RF1, RF2			96.4 ~ 01.4	HN-254	HN-255	
RF3, RF4			01.4 ~ 05.5	HN-254	HN-255	
RF5, RF6			03.6 ~ 05.5	HN-254	HN-255	
RG1, RG2	TYPE G,B		05.5 ~ 09.10	HN-509	HN-506	
RK1, 2, 3, 4, 5, 6, 7			09.10 ~ 15.3	HN-485	HN-580	
2400 RF7, RF8			03.6 ~ 05.5	HN-254	HN-255	
RG3, RG4	TYPE Z		05.5 ~ 09.10	HN-509	HN-506	
STREAM						
1700 RN1			00.10 ~ 06.7	HN-264		FN-5524
	ABSOLUTE		03.9 ~ 06.7	HN-465	HN-255	
RN2	4WD		00.10 ~ 06.7	HN-264		FN-5524

HONDA - 8

Model 車種形式	Year 年式	Front フロント		Rear リア		Parking パーキング
		Pad パッド	Shoe シュー	Pad パッド	Shoe シュー	Shoe シュー
STREAM						
1800 RN6	06. 7 ~ 15. 5	HN-509			FN-5524	
RN7 4WD	06. 7 ~ 15. 5	HN-509		HN-506		
2000 RN3	00.10 ~ 06. 7	HN-465		HN-255		
RN4 4WD	01. 1 ~ 06. 7	HN-465		HN-255		
RN5 ABSOLUTE	03.12 ~ 06. 7	HN-465		HN-255		
RN8	06. 7 ~ 15. 5	HN-509		HN-506		
RN9 4WD	06. 7 ~ 15. 5	HN-509		HN-506		
ZEST						
660 JE1	06. 3 ~ 12.11	HN-336			FN-5541	
SPOTS G TURBO	06. 3 ~ 12.11	HN-558			FN-5541	
JE2	06. 3 ~ 12.11	HN-336			FN-5520	
SPOTS G TURBO	06. 3 ~ 12.11	HN-558			FN-5520	
TODAY						
660 JA2, JW3	90. 2 ~ 94. 9	HN-278			FN-5521	
JW3	94. 9 ~ 98.10	HN-336			FN-5521	
JW4	94. 9 ~ 98.10	HN-336			FN-5519	
JA4	93. 1 ~ 98.10	HN-336			FN-5032	
JA5	93. 1 ~ 98.10	HN-336			FN-5519	
DOMANI						
1500 MA7	94. 2 ~ 97. 1	HN-265			FN-5518	
MB3 W/O ABS	97. 1 ~ 00. 8	HN-265			FN-5518	
W/ ABS	97. 1 ~ 00. 8	HN-265			FN-5520	
1600 MA4	92.10 ~ 97. 1	HN-265		HN-266	FN-5518	
AT W/O ABS	92.10 ~ 97. 1	HN-265			FN-5520	
W/ ABS	92.10 ~ 97. 1	HN-264		HN-266		
MA6 W/O ABS	92.10 ~ 97. 1	HN-265			FN-5520	
W/ ABS	92.10 ~ 97. 1	HN-264			FN-5520	
MB4 16X	97. 1 ~ 00. 8	HN-265			FN-5520	
16G W/O ABS	97. 1 ~ 00. 8	HN-265			FN-5518	
W/ ABS	97. 1 ~ 00. 8	HN-265			FN-5520	
MB5	97. 1 ~ 00. 8	HN-264			FN-5520	
1800 MA5	92.10 ~ 97. 1	HN-264		HN-266	FN-5520	
TORNEO						
1800 CF3	97. 8 ~ 02.10	HN-423		HN-397		
2000 CF4, CF5	97. 8 ~ 02.10	HN-254		HN-397		
CL3	00. 6 ~ 02.10	HN-254		HN-397		
200 CL1 EURO-R	00. 6 ~ 02.10	HN-445		HN-397		
PARTNER						
1300 EY6	96. 2 ~ 03. 8	HN-265			FN-5520	
1500 EY7	96. 2 ~ 06. 3	HN-265			FN-5520	
GJ3	06. 3 ~ 10. 8	HN-265			FN-5524	
GJ4	06. 7 ~ 10. 8	HN-265			FN-5524	

- NISSAN
- TOYOTA
(HINO)
- MAZDA
- ISUZU
- HONDA**
- MITSUBISHI
- SUBARU
- SUZUKI
- DAIHATSU
- LEXUS
- INFINITY
- HYUNDAI
- KIA

HONDA - 9

- NISSAN
- TOYOTA
(HINO)
- MAZDA
- ISUZU
- HONDA**
- MITSUBISHI
- SUBARU
- SUZUKI
- DAIHATSU
- LEXUS
- INFINITI
- HYUNDAI
- KIA

Model 車種形式	Year 年式	Front フロント		Rear リア		Parking パーキング
		Pad パッド	Shoe シュー	Pad パッド	Shoe シュー	Shoe シュー
PARTNER						
1600 EY8	96. 2 ~ 06. 3	HN-265			FN-5520	
EY9	97. 2 ~ 99. 5	HN-265			FN-5520	
VAMOS						
660 HM1, HM2	99. 5 ~	HN-336			FN-5520	
HM3, HM4	03. 4 ~	HN-336			FN-5520	
HJ1, HJ2 HOB10	03. 4 ~	HN-336			FN-5520	
BEAT						
660 PP1	91. 5 ~ 96. 1	HN-278		HN-266		
FIT						
1300 GD1	01. 6 ~ 07.10	HN-263			FN-5534	
1.3S	04. 6 ~ 07.10	HN-510		HN-266	FN-5534	
GD2 4WD	01. 6 ~ 07.10	HN-510			FN-5520	
GD6 ARIA	02.11 ~ 05.10	HN-263			FN-5534	
GD7 ARIA	02.11 ~ 05.10	HN-510			FN-5520	
GE6	07.10 ~ 09.11	HN-263			FN-5534	
OPTION (151NCH AW)	07.10 ~ 09.11	HN-264			FN-5547	
OPTION, VSA	09.11 ~ 13. 9	HN-560		HN-266		
GE7 4WD	07.10 ~ 09.11	HN-264			FN-5547	
	09.11 ~ 13. 9	HN-560			FN-5547	
1500 GD3	02. 9 ~ 07.10	HN-510		HN-266	FN-5534	
GD4 4WD	02. 9 ~ 07.10	HN-510			FN-5520	
GD8 ARIA	02.11 ~ 09. 1	HN-510			FN-5534	
GD9 ARIA	02.11 ~ 09. 1	HN-510			FN-5520	
GE8 CVT	07.10 ~ 09.11	HN-264			FN-5547	
CVT VSA 161NCH AW	07.10 ~ 09.11	HN-264		HN-266		
5F M/T, RS, X	07.10 ~ 10.10	HN-560		HN-266		
GE9 4WD	07.10 ~ 09.11	HN-264			FN-5547	
	09.11 ~ 13. 9	HN-560			FN-5547	
FIT SHUTTLE						
1500 GG7	11.06 ~ 15. 5	HN-560			FN-5547	
GG8 4WD	11.06 ~ 15. 5	HN-560			FN-5547	
GP2 HYBRID	11.06 ~ 15. 5	HN-560			FN-5547	
FREED						
1500 GB3	~1300000	08. 5 ~ 10.10	HN-264		FN-5524	
	1300001~	10.10 ~ 16. 9	HN-560		FN-5524	
	SPIKE	10. 7 ~ 11.10	HN-264		FN-5524	
	SPIKE	11.10 ~ 16. 9	HN-560		FN-5524	
GB4		08. 5 ~ 11.10	HN-264		FN-5524	
GB4		11.10 ~	HN-560		FN-5524	
GP3		11.10 ~	HN-560		FN-5524	
PRELUDE						
2000 BA4 XL	88. 1 ~ 91. 9	HN-191		HN-206		
SI	88. 8 ~ 91. 9	HN-162		HN-206		

HONDA - 10

Model 車種形式	Year 年式	Front フロント		Rear リア		Parking パーキング
		Pad パッド	Shoe シュー	Pad パッド	Shoe シュー	Shoe シュー
PRELUDE						
2000 BA5	XX	88. 8 ~ 91. 9	HN-191		HN-266	
	S1	88. 8 ~ 91. 9	HN-162		HN-266	
2200 BA8, BA9		91. 9 ~ 96.11	HN-293		HN-397	
	BB1, BB4	91. 9 ~ 96.11	HN-254		HN-397	
	BB5, BB7	96.10 ~ 00. 8	HN-293		HN-397	
	BB6, BB8	96.10 ~ 00. 8	HN-254		HN-397	
HORIZON						
3000 UBS73GWH		98. 2 ~	HN-258		HN-299	
3100 UBS69GWH		94. 2 ~ 98. 3	HN-258		HN-299	
3200 UBS25GWH		94. 2 ~ 98. 3	HN-258		HN-299	
3500 UBS26GWH		98. 2 ~	HN-258		HN-299	
MOBILIO						
1500 GB1, GB2		01.12 ~ 08. 7	HN-264			FN-5524
	GK1, GK2 SPIKE	02. 9 ~ 08. 7	HN-264			FN-5524
LIFE						
660 JA4		97. 5 ~ 98.10	HN-336			FN-5032
	JB1	98.10 ~ 03. 9	HN-336			FN-5529
	JB2 4WD	98.10 ~ 03. 9	HN-336			FN-5520
	JB3 DUNK TURBO	00.12 ~ 03. 9				FN-5529
	JB4 DUNK TURBO 4WD	00.12 ~ 03. 9				FN-5520
	JB5	03. 9 ~ 08.11	HN-336			FN-5541
	JB6	03. 9 ~ 08.11	HN-336			FN-5520
	JB7	03.10 ~ 08.11	HN-558			FN-5541
	JB8	03.10 ~ 08.11	HN-558			FN-5520
	JC1 EXCL. TURBO	08.11 ~ 14. 4	HN-278			FN-5541
	TURBO	08.11 ~ 14. 4	HN-558			FN-5541
	JC2 EXCL. TURBO	08.11 ~ 14. 4	HN-278			FN-5547
	TURBO	08.11 ~ 14. 4	HN-558			FN-5547
LAGREAT						
3500 RL1		IMPORT 99. 6 ~ 01.11				
		IMPORT 01.11 ~ 04. 5				
RAFAGA						
2000 CE4		93.10 ~ 98. 3	HN-223		HN-397	FN-5524
2500 CE5		93.10 ~ 98. 3	HN-254		HN-397	
LEGEND						
3200 KA7		90.10 ~ 96. 2	HN-254		HN-255	
	KA8	90.12 ~ 96. 2	HN-254		HN-255	
3500 KA9		~No. 1200000	96. 1 ~ 98.10	HN-254	HN-255	
		No. 1200001~	98.10 ~ 04.10	HN-254	HN-255	
	EURO	No. 1200001~	98.10 ~ 04.10	HN-445	HN-255	
	KB1		04.10 ~ 08. 9			
3700 KB2			08. 9 ~			
LOGO						
1300 GA3		96. 9 ~ 01. 6	HN-263			FN-5525
	TS		98.11 ~ 01. 6	HN-510		FN-5525
	GA5		98.11 ~ 01. 6	HN-510		FN-5520

- NISSAN
- TOYOTA (HINO)
- MAZDA
- ISUZU
- HONDA**
- MITSUBISHI
- SUBARU
- SUZUKI
- DAIHATSU
- LEXUS
- INFINITY
- HYUNDAI
- KIA

MITSUBISHI - 1

- NISSAN
- TOYOTA
(HINO)
- MAZDA
- ISUZU
- HONDA
- MITSUBISHI**
- SUBARU
- SUZUKI
- DAIHATSU
- LEXUS
- INFINITI
- HYUNDAI
- KIA

Model 車種形式		Year 年式	Front フロント		Rear リア		Parking パーキング
			Pad パッド	Shoe シュー	Pad パッド	Shoe シュー	Shoe シュー
eK WAGON ・ SPORT							
660	H81W	01.10 ~ 06. 9	HN-453			FN-6726	
	H82W	06. 9 ~ 07. 7	HN-453			FN-6726	
		07. 8 ~ 13. 6	HN-437			FN-6726	
	TURBO	07. 8 ~ 13. 6	HN-453			FN-6726	
	B11W	13. 6 ~	HN-570			FN-6726	
F T O							
1800	DE2A GS	94. 9 ~ 99. 8	HN-271		HN-314		
2000	DE3A GR, GX	94. 9 ~ 00. 7	HN-271		HN-314		
	GP-X, GP-R	94. 9 ~ 00. 7	HN-233		HN-314		
G T O							
3000	Z15A	90.10 ~ 94. 7	HN-352		HN-272		
		94. 8 ~ 95. 6	HN-352		HN-338		
	MNPM, MRPM	95. 7 ~ 00. 7	HN-352		HN-272		
	MJGF	95. 7 ~ 00. 7	HN-352		HN-338		
	Z16A	90.10 ~ 92. 9	HN-352		HN-272		
		92.10 ~ 00. 7	HN-352		HN-338		
i							
660	HA1W	05.12 ~ 13. 6	HN-426			FN-1267	
R V R ・ RVR ROADEST							
1800	N11W	W/O ABS 91. 6 ~ 97.11	HN-271			FN-6701	
		W/ ABS 91. 6 ~ 97.11	HN-271		HN-174		
	N21W	W/O ABS 91. 6 ~ 97.11	HN-271			FN-6687	
		W/ ABS 91. 6 ~ 97.11	HN-271		HN-174		
	N21WG	96. 5 ~ 97.11	HN-271		HN-174	FN-6687	
	N61W, N71W	97. 9 ~ 02. 8	HN-419			FN-6723	
	GA3W	10. 2 ~ 12. 9	HN-548		HN-450		
	GA4W	10. 2 ~ 12. 9	HN-548		HN-450		
2000	N13W	91. 1 ~ 97.11	HN-271		HN-174		
	N23W, N23WG	91. 1 ~ 97.11	HN-271		HN-174		
	TURBO	94. 9 ~ 97.11	HN-233		HN-174		
	N28W, N28WG	92. 9 ~ 97.11	HN-271		HN-174	FN-6687	
	N73WG	97. 9 ~ 00.11	HN-419		HN-174		
2400	N64WG, N74WG	97. 9 ~ 02. 8	HN-419			FN-6723	
i-MiEV							
	HA3W	09. 7 ~ 10. 9	HN-426			FN-1267	
		10.10 ~				FN-1267	
OUTLANDER							
2000	CW4W	10. 1 ~ 12.10	HN-548		HN-450		
2400	CW5W	05.10 ~ 12.10	HN-548		HN-450		

MITSUBISHI - 2

Model 車種形式	Year 年式	Front フロント		Rear リア		Parking パーキング
		Pad パッド	Shoe シュー	Pad パッド	Shoe シュー	Shoe シュー
OUTLANDER						
2400 GF8W	12.10 ~	HN-548				
3000 CW6W	07.10 ~ 09.9	HN-548		HN-450		
AIRTREK						
2000 CU2W	01.6 ~ 05.9	HN-548			FN-6723	
TURBO 4WD	02.6 ~ 05.9	HN-233		HN-502		
2400 CU4W	01.6 ~ 04.1	HN-548			FN-6723	
sports gear	03.1 ~ 04.1	HN-548		HN-502		
CU5W	04.1 ~ 05.9	HN-548		HN-502		
ECLIPSE						
2000 D22A	89.9 ~ 90.1	HN-271		HN-110		
	90.1 ~ 95.1	HN-271		HN-284		
D27A	89.9 ~ 92.6	HN-271		HN-110		
	92.7 ~ 95.1	HN-233		HN-110		
D32A, D38A	95.2 ~ 99.6	HN-271		HN-174		
D53A	04.7 ~ 05.4	HN-548		HN-174		
ETERNA SAVA						
1800 E32A	89.10 ~ 92.5	HN-271			FN-6701	
E34A	89.10 ~ 92.5	HN-285			FN-6701	
E35A ZX	89.10 ~ 92.5	HN-271			FN-6701	
LX	89.10 ~ 92.5	HN-271		HN-284		
E37A	89.10 ~ 92.5	HN-271		HN-110		
2000 E33A	90.8 ~ 92.5	HN-271		HN-284		
E39A	89.10 ~ 92.5	HN-271		HN-110		
EMERAUDE						
1800 E52A, E53A	92.7 ~ 96.8	HN-271			FN-6701	
2000 E54A	92.7 ~ 96.8	HN-271		HN-174	FN-6701	
VXR	93.9 ~ 96.8	HN-233		HN-174		
E64A	93.9 ~ 96.8	HN-233		HN-174		
E74A	92.2 ~ 94.8	HN-233		HN-272		
TURBO	94.8 ~ 96.8	HN-233		HN-272		
	94.8 ~ 96.8	HN-233		HN-174		
E84A	92.7 ~ 94.10	HN-233		HN-174	FN-6701	
CARISMA						
1800 DA2A	96.10 ~ 98.9				FN-6701	
	98.10 ~ 99.10				FN-6733	
GALANT・ASPIRE						
1600 E31A	89.10 ~ 92.5	HN-285			FN-6712	
1800 E12A GAS	83.8 ~ 96.1	HN-158			FN-6669	

NISSAN

TOYOTA
(HINO)

MAZDA

ISUZU

HONDA

MITSUBISHI

SUBARU

SUZUKI

DAIHATSU

LEXUS

INFINITY

HYUNDAI

KIA

MITSUBISHI - 3

- NISSAN
- TOYOTA
(HINO)
- MAZDA
- ISUZU
- HONDA
- MITSUBISHI**
- SUBARU
- SUZUKI
- DAIHATSU
- LEXUS
- INFINITI
- HYUNDAI
- KIA

Model 車種形式	Year 年式	Front フロント		Rear リア		Parking パーキング
		Pad パッド	Shoe シュー	Pad パッド	Shoe シュー	Shoe シュー
GALANT・ASPIRE						
1800 E12A LPG	83. 8 ~ 90. 7	HN-158			FN-6687	
	90. 7 ~ 96. 1	HN-285			FN-6687	
E19A	96. 1 ~ 99. 8	HN-285			FN-6687	
E32A	89.10 ~ 92. 5	HN-271			FN-6701	
E32AR, E34AR	89.10 ~ 92. 5	HN-285			FN-6687	
E34A	89.10 ~ 92. 5	HN-285			FN-6701	
E35A	89.10 ~ 92. 5	HN-271		HN-284	FN-6701	
E37A	90.10 ~ 92. 5	HN-271		HN-110		
E52A, E53A	92. 3 ~ 96. 8	HN-271			FN-6701	
E72A	92. 3 ~ 96. 8	HN-271			FN-6687	
EA1A	96. 7 ~ 00. 5	HN-271		HN-174	FN-6701	
EC1A	96.10 ~ 00. 5	HN-271		HN-174	FN-6687	
2000						
E33A	89.10 ~ 92. 5	HN-271		HN-284		
	AMG					
E38A	89.10 ~ 92. 5	HN-233		HN-284		
E39A	89.10 ~ 92. 5	HN-233		HN-110		
E39A	90. 9 ~ 92. 9	HN-271		HN-110		
	TURBO					
E54A	89.10 ~ 92. 5	HN-233		HN-110		
	VXR					
E64A	92. 3 ~ 96. 8	HN-271		HN-174	FN-6701	
E84A	92. 3 ~ 96. 8	HN-233		HN-174		
E57A	92. 3 ~ 96. 8	HN-233		HN-272		
E77A	92. 6 ~ 96. 8	HN-271			FN-6701	
E74A	92. 6 ~ 96. 8	HN-271			FN-6687	
	TURBO					
EA7A	93. 2 ~ 96. 8	HN-233		HN-174		
EC7A	93. 2 ~ 96. 8	HN-233		HN-272		
	TURBO					
EA7A	00. 5 ~ 05.11	HN-271		HN-174	FN-6701	
EC7A	00. 5 ~ 05.11	HN-271		HN-174	FN-6687	
2400						
EA3A, EC3A	98. 8 ~ 00. 4	HN-233		HN-174		
	00. 5 ~ 02. 9	HN-548		HN-174		
2500						
EC5A VR-4	96. 7 ~ 02. 9	HN-233		HN-272		
GALANT FORTIS						
1800						
CY6A	11.10 ~ 15. 3	HN-548			FN-1267	
CX6A	11.10 ~ 15. 3	HN-548		HN-450		
2000						
CY4A	SPORT, SPORT NAVI-PKG, SPORT X	07. 8 ~ 08. 5	HN-548		HN-450	
	EXCEPT ABOVE	07. 8 ~ 08. 5	HN-548		HN-502	
	RALLIART	08. 5 ~	HN-233		HN-450	
	EXCEPT RALLIART, SPORT, SPORT NAVI-PKG, SPORT X	08. 5 ~	HN-548		HN-450	
	EXCEPT ABOVE	08. 5 ~	HN-548		HN-502	
CX4A	RALLIART	08.11 ~ 15. 3	HN-233		HN-450	
	SPORT	08.11 ~ 09.12	HN-548		HN-450	
	TOURING	08.11 ~ 09.12	HN-548		HN-502	
CANTER						
2000 FA500	97. 6 ~ 99. 4	HN-346			FN-6655	FN-6600

MITSUBISHI - 4

Model 車種形式	Year 年式	Front フロント		Rear リア		Parking パーキング
		Pad パッド	Shoe シュー	Pad パッド	Shoe シュー	Shoe シュー
CANTER						
2000 FA510	B0 series		HN-468			FN-6655 FN-6600
	A1,B1 series		HN-346			FN-6655 FN-6600
FA580,FA590			HN-346			FN-6655 FN-6600
FB500			HN-346			FN-4447 FN-6600
FB510	DOUBLE TYRES FLAT-LOW		HN-346			FN-4447 FN-6600
	DOUBLE TYRES 1.5t FULL FLAT-LOW		HN-468			FN-6655 FN-6600
FB700			HN-515		HN-515	FN-6655 FN-6600
2400 FA523			HN-346			FN-6655 FN-6600
FC563			HN-407			FN-6653 FN-4443
FB523			HN-346			FN-4447 FN-6600
FE533			HN-407	FN-6722		FN-6653 FN-4443
2700 FB100,FE100				FN-6654		FN-6656 FN-6600
FB120				FN-6654		FN-6655 FN-6600
FB300			HN-222			FN-6656 FN-6600
	DOUBLE TYRES		HN-222			FN-6655 FN-6600
		FLAT-LOW	HN-345			FN-6655 FN-6600
FE300,FE320			HN-222			FN-6668 FN-6600
2800 FB308	SINGLE TYRE, SMALL DOUBLE TYRES		HN-222			FN-6656 FN-6600
	EXCEPT ABOVE		HN-345			FN-6655 FN-6600
	SINGLE TYRE, SMALL DOUBLE TYRES		HN-347			FN-6656 FN-6600
	SINGLE TYRE, SMALL DOUBLE TYRES		HN-347			FN-6655 FN-6600
	EXCEPT ABOVE		HN-346			FN-6655 FN-6600
FB328			HN-346			FN-6655 FN-6600
FB501			HN-346			FN-6655 FN-6600
FB511	ULTRA LOW FLOOR		HN-468			FN-6655 FN-6600
	DOUBLE TYRES FULL LOW FLOOR		HN-346			FN-6655 FN-6600
	AERIAL WORK PLATFORMS		HN-349			FN-6655 FN-6600
FB50A	DOUBLE TYRES FULL LOW FLOOR		HN-346			FN-4447 FN-4443
	DOUBLE TYRES ULTRA LOW FLOOR		HN-346			FN-6655 FN-4443
FB51A	A1,B1 series FULL LOW FLOOR		HN-346			FN-4447 FN-4443
	A1A46,A1A47 series FULL LOW FLOOR		HN-349			FN-6602 FN-4443
	B0 series FULL LOW FLOOR		HN-468			FN-6655 FN-4443
	B0 series FULL LOW FLOOR		HN-347			FN-6655 FN-4443
	BOVR86,BOR86 series ULTRA LOW FLOOR		HN-468			FN-6655 FN-4443
	BOVR86,BOR86 series ULTRA LOW FLOOR		HN-347			FN-6655 FN-4443
FB70A			HN-515		HN-515	FN-6655 FN-6600
FD378			HN-346			FN-6655 FN-6600
FD501			HN-346			FN-6655 FN-6600
FD50A	SINGLE TYRE		HN-346			FN-6655
	DOUBLE TYRES		HN-346			FN-4447
FD70A			HN-515		HN-515	FN-6681
3000 FB70B			HN-515		HN-515	FN-6600
			HN-576		HN-576	
FD70B			HN-515		HN-515	FN-4466
FE70B,FE72B			HN-514			FN-6602 FN-4466

NISSAN

TOYOTA
(HINO)

MAZDA

ISUZU

HONDA

MITSUBISHI

SUBARU

SUZUKI

DAIHATSU

LEXUS

INFINITY

HYUNDAI

KIA

MITSUBISHI - 5

- NISSAN
- TOYOTA
(HINO)
- MAZDA
- ISUZU
- HONDA
- MITSUBISHI**
- SUBARU
- SUZUKI
- DAIHATSU
- LEXUS
- INFINITI
- HYUNDAI
- KIA

Model 車種形式	Year 年式	Front フロント		Rear リア		Parking パーキング	
		Pad パッド	Shoe シュー	Pad パッド	Shoe シュー	Shoe シュー	
CANTER							
3000 FE71B	04. 4 ~ 09. 4	HN-514		HN-514	FN-6602	FN-4466	
FE73B	EXCEPT VAN 04. 4 ~ 09. 4	HN-513			FN-6653	FN-4466	
	VAN 04. 4 ~ 09. 4	HN-514			FN-6602	FN-4466	
FE82B	04. 4 ~ 09. 4	HN-514			FN-6602	FN-4466	
FE84B	04. 4 ~ 09. 4	HN-513			FN-6722	FN-4466	
3300	FE101, 111, 114, 120, 124, 211, 214, 221, 224	1.75t, 2t	78. 1 ~ 83. 3		FN-6627	FN-6602	FN-6600
			83. 3 ~ 85. 10		FN-6667	FN-6668	FN-6600
	FE111, 114, 131, 134, 211, 214, 231, 234	2.75t, 3t, 3.5t	78. 1 ~ 80. 10		FN-6627	FN-6602	FN-6600
			80. 10 ~ 85. 10		FN-6653	FN-6668	FN-6600
			80. 10 ~ 85. 10		FN-6653	FN-6653	FN-6600
FE301	BFE, BFEW series	85. 10 ~ 91. 4	HN-175			FN-6668	FN-6600
		85. 10 ~ 91. 4	HN-222			FN-6668	FN-6600
	BFE, BFEW series	91. 4 ~ 93. 10	HN-348			FN-6668	FN-6600
		91. 4 ~ 93. 10	HN-347			FN-6668	FN-6600
FE311	CARGO	85. 10 ~ 91. 4	HN-175			FN-6668	FN-6600
	CARGO	91. 4 ~ 93. 10	HN-348			FN-6668	FN-6600
	DUMP TRUCK, SPECIALLY EQUIPPED CAR	85. 10 ~ 93. 10	HN-349			FN-6668	FN-6600
FE321	ETE series	FULL LOW FLOOR	89. 10 ~ 91. 4	HN-222		FN-6668	FN-6600
	ETE series	ULTRA LOW FLOOR	89. 10 ~ 91. 4	HN-175		FN-6668	FN-6600
	EFE series	FULL LOW FLOOR	91. 4 ~ 93. 10	HN-347		FN-6668	FN-6600
	EFE series	ULTRA LOW FLOOR	91. 4 ~ 93. 10	HN-348		FN-6668	FN-6600
FE331		85. 10 ~ 91. 4	HN-175			FN-6668	FN-6600
		91. 4 ~ 93. 10	HN-348			FN-6668	FN-6600
FE334	2t	85. 10 ~ 89. 10	HN-175	FN-6667		FN-6668	FN-6681
	2.75t, 3t	85. 10 ~ 89. 10	HN-175	FN-6653		FN-6653	FN-6681
FE431		85. 10 ~ 89. 10	HN-175			FN-6602	FN-6600
FE434	2t	85. 10 ~ 89. 10	HN-175	FN-6667		FN-6668	FN-6681
	2.75t, 3t	85. 10 ~ 89. 10	HN-175	FN-6653		FN-6653	FN-6681
FE444		85. 10 ~ 89. 10		FN-6653		FN-6653	FN-6681
3600 FE305	FRONT DRUM	85. 10 ~ 93. 10		FN-6667		FN-6668	FN-6600
	BFE, BFM series	85. 10 ~ 91. 4	HN-175			FN-6668	FN-6600
	BFE, BFM series	91. 4 ~ 93. 10	HN-348			FN-6668	FN-6600
	BDGE, BDGEQ series	89. 10 ~ 93. 10	HN-349			FN-6668	FN-6600
	EXCEPT ABOVE	85. 10 ~ 91. 4	HN-222			FN-6668	FN-6600
		91. 4 ~ 93. 10	HN-347			FN-6668	FN-6600
FE315	FRONT DRUM	85. 10 ~ 93. 10		FN-6667		FN-6668	FN-6600
	BH series	85. 10 ~ 91. 4	HN-175			FN-6668	FN-6600
	BH series	91. 4 ~ 93. 10	HN-348			FN-6668	FN-6600
	BD, BN series	85. 10 ~ 93. 10	HN-349			FN-6668	FN-6600
FE325	FRONT DRUM	85. 10 ~ 93. 10		FN-6667		FN-6668	FN-6600
		85. 10 ~ 91. 4	HN-175			FN-6668	FN-6600
	BV, EV, ET series	91. 4 ~ 93. 10	HN-347			FN-6668	FN-6600
	EF, BF series	91. 4 ~ 93. 10	HN-348			FN-6668	FN-6600
FE335	BV, EH, EV series FRONT DRUM	85. 10 ~ 93. 10		FN-6667		FN-6668	FN-6600
	EXCEPT ABOVE FRONT DRUM	85. 10 ~ 93. 10		FN-6653		FN-6653	FN-6600
	CARGO 2t	85. 10 ~ 91. 4	HN-175			FN-6668	FN-6600
		91. 4 ~ 93. 10	HN-348			FN-6668	FN-6600

MITSUBISHI - 6

Model 車種形式	Year 年式	Front フロント		Rear リア		Parking パーキング
		Pad パッド	Shoe シュー	Pad パッド	Shoe シュー	Shoe シュー
CANTER						
3600 FE335	CARGO 2.75t,3t	85.10 ~ 91.4	HN-175			FN-6653 FN-6600
		91.4 ~ 93.10	HN-348			FN-6653 FN-6600
	PICKUP TRUCK 2t	85.10 ~ 93.10	HN-349			FN-6668 FN-6600
	PICKUP TRUCK 2.75t,3t	85.10 ~ 93.10	HN-349			FN-6653 FN-6600
FE355		85.10 ~ 93.10		FN-6653		FN-6653 FN-6600
FE425	FRONT DRUM	85.10 ~ 93.10		FN-6667		FN-6668 FN-6600
	ETEQ series	87.8 ~ 89.10	HN-222			FN-6668 FN-6600
	EXCEPT ETEQ series	85.10 ~ 91.4	HN-175			FN-6668 FN-6600
	EXCEPT ETEQ series	91.4 ~ 93.10	HN-348			FN-6668 FN-6600
FE435	CHE,EHE series	85.10 ~ 91.4	HN-175			FN-6668 FN-6600
	CHE,EHE series	91.4 ~ 93.10	HN-348			FN-6668 FN-6600
	ED,EV,FG,FH series	85.10 ~ 93.10	HN-349			FN-6668 FN-6600
FE445,FE465		85.10 ~ 93.10		FN-6653		FN-6653 FN-6600
FG325,FG435		85.12 ~ 93.10		FN-6653		FN-6653 FN-6600
FG335		85.10 ~ 97.4		FN-6653		FN-6653 FN-6600
FE516	FRONT DRUM	93.10 ~ 99.4		FN-6653		FN-6653 FN-4443
	B1·4,BC,BD,BN series	93.10 ~ 99.4	HN-349			FN-6602 FN-4443
	BT series	93.10 ~ 99.4	HN-347			FN-6602 FN-4443
FE536		93.10 ~ 99.4	HN-349			FN-6602 FN-4443
FE566		96.10 ~ 99.4	HN-407	FN-6722		※ FN-4443
※REAR DRUM BREAD 75mm=FN-6653,110mm=FN-6722						
FE636		93.10 ~ 99.4	HN-349			FN-6602 FN-4443
3900 FE439	2t	89.11 ~ 93.10	HN-349	FN-6653		FN-6668 FN-6681
	3t	89.11 ~ 93.10	HN-349	FN-6653		FN-6653 FN-6681
FE449		89.11 ~ 93.10		FN-6653		FN-6653 FN-6681
FE639	1.5t,2t	93.10 ~ 99.4	HN-349	FN-6653	HN-348	FN-6602 FN-4443
	3t,3.5t,4t	96.11 ~ 99.4	HN-407	FN-6653	HN-407	FN-6653 FN-4443
FE649		93.10 ~ 99.4	HN-407	FN-6653		FN-6653 FN-4443
FE659		95.3 ~ 96.11		FN-3366		FN-4443
		96.11 ~ 99.4		FN-6722		FN-6722 FN-4443
		96.11 ~ 99.5		FN-6722		FN-6602 FN-4443
FE669	1.5t,2t	96.10 ~ 99.4	HN-349	FN-6653		※ FN-4443
	3t,3.5t,4t	96.10 ~ 99.4	HN-407	FN-6653		※ FN-4443
※FRONT DRUM BREAD 75mm=FN-6653,110mm=FN-6722 ※REAR DRUM BREAD 60mm=FN-6602,75mm=FN-6653,110mm=FN-6722						
4200 FE307		89.11 ~ 93.10	HN-349			FN-6668 FN-6681
FE317		88.11 ~ 93.10	HN-349			FN-6668 FN-6681
	BNHEB series	88.11 ~ 93.10	HN-349			FN-6668 FN-6600
FE337,FE437	2t	87.11 ~ 93.10	HN-349	FN-6653		FN-6668 FN-6681
	2.75t,3t	87.11 ~ 93.10	HN-349	FN-6653		FN-6653 FN-6681
FE447,FE467		87.11 ~ 93.10		FN-6653		FN-6653 FN-6681
FG327,FG337,FG437		89.11 ~ 93.10		FN-6653		FN-6653 FN-6681
FG507		96.11 ~ 99.5	HN-349			FN-6602 FN-4443
FG537		93.10 ~ 95.3		FN-6653		FN-6653 FN-4443
FE507	B1MA56 series	93.10 ~ 99.4	HN-349			FN-6722 FN-4443
	EXCEPT ABOVE	93.10 ~ 99.4	HN-349			FN-6602 FN-4443
FE517		93.10 ~ 99.4	HN-349	FN-6653		FN-6602 FN-4443
	REFUSE VEHICLES	93.10 ~ 99.4	HN-349	FN-6653		FN-6653 FN-4443

- NISSAN
- TOYOTA (HINO)
- MAZDA
- ISUZU
- HONDA
- MITSUBISHI
- SUBARU
- SUZUKI
- DAIHATSU
- LEXUS
- INFINITY
- HYUNDAI
- KIA

MITSUBISHI - 7

- NISSAN
- TOYOTA
(HINO)
- MAZDA
- ISUZU
- HONDA
- MITSUBISHI**
- SUBARU
- SUZUKI
- DAIHATSU
- LEXUS
- INFINITI
- HYUNDAI
- KIA

Model 車種形式	Year 年式	Front フロント		Rear リア		Parking パーキング
		Pad パッド	Shoe シュー	Pad パッド	Shoe シュー	Shoe シュー
CANTER						
4200 FE527	95. 3 ~ 99. 4	HN-349			FN-6602	FN-4443
FE537 1.5t,2t	93.10 ~ 99. 4	HN-349	FN-6653		FN-6602	FN-4443
FE537 3t,3.5t,4t	93.10 ~ 99. 4	HN-349	FN-6653		FN-6653	FN-4443
BD series	96.11 ~ 99. 4	HN-407			FN-6653	FN-4443
FE537 EXCEPT BD series	93.10 ~ 99. 4	HN-349			FN-6653	FN-4443
FE567	96.10 ~ 99. 4	※	※		※	FN-4443
※FRONT DISC PF-3349/PF-3407 ※FRONT DRUM BREAD 75mm=FN-6653,110mm=FN-6722 ※REAR DRUM BREAD 60mm=FN-6602,75mm=FN-6653,110mm=FN-6722						
FE637 1.5t,2t	93.10 ~ 99. 4	HN-349	FN-6653		FN-6602	FN-4443
3t,3.5t,4t	93.10 ~ 95. 3	HN-349	FN-6653		FN-6653	FN-4443
3t,3.5t,4t	95. 3 ~ 99. 4	HN-349	FN-6653		FN-6602	FN-4443
FE667 EV688 series	96.10 ~ 99. 4	HN-407			FN-6653	FN-4443
EXCEPT ABOVE	96.10 ~ 99. 4	HN-349			FN-6602	FN-4443
FE50C B1R46 series	99. 5 ~ 02. 5	HN-349			FN-6722	FN-4443
EXCEPT ABOVE	99. 5 ~ 02. 5	HN-349			FN-6602	FN-4443
FE51C BA,BD series	99. 5 ~ 02. 5	HN-407			FN-6653	FN-4443
EXCEPT ABOVE	99. 5 ~ 02. 5	HN-349			FN-6602	FN-4443
FE52C	99. 5 ~ 02. 5	HN-349			FN-6602	FN-4443
FE53C VAN	99. 5 ~ 02. 5	HN-349	FN-6653		FN-6602	FN-4443
TRUCK B4UGM, EV6KR series	99. 5 ~ 02. 5	HN-407			FN-6722	FN-4443
EXCEPT ABOVE	99. 5 ~ 02. 5	HN-407			FN-6653	FN-4443
FE63C EV3,6 series	99. 5 ~ 02. 5	HN-407	FN-6653		FN-6653	FN-4443
ET, EV1・4, E1・4 series	99. 5 ~ 02. 5	HN-349	FN-6653		FN-6653	FN-4443
FE70C	02. 5 ~ 04. 8	HN-514			FN-6602	FN-4443
FE71C, FE72C	02. 5 ~ 04. 8	HN-514			FN-6602	FN-4443
FE73C EV1, EV4 series	02. 5 ~ 04. 8	HN-514			FN-6602	FN-4443
B, EV6 series	02. 5 ~ 04. 8	HN-513			FN-6653	FN-4443
FE82C	02. 5 ~ 04. 8	HN-514			FN-6602	FN-4443
FE83C EV1, EV4 series	02. 5 ~ 04. 8	HN-514			FN-6602	FN-4443
EV3, EV6 series	02. 5 ~ 04. 8	HN-513			FN-6653	FN-4443
4600 FE508, FE518	93.10 ~ 99. 4	HN-349			FN-6602	FN-4443
FE528	95. 3 ~ 99. 4	HN-349			FN-6602	FN-4443
FE538 1.5t,2t	93.10 ~ 99. 4	HN-349	FN-6653		FN-6602	FN-4443
3t,3.5t,4t	93.10 ~ 96.10	HN-349	FN-6653		FN-6653	FN-4443
3t,3.5t,4t	96.11 ~ 99. 4	HN-407	FN-6653		FN-6653	FN-4443
FE548 B6K72 series	95. 3 ~ 99. 4		FN-6722		FN-6722	FN-4443
EXCEPT ABOVE	95. 3 ~ 99. 4		FN-6653		FN-6653	FN-4443
FE568 VAN 1.5t,2t	96.10 ~ 99. 4	HN-349	FN-6653		FN-6602	FN-4443
VAN 3t,3.5t,4t	96.10 ~ 99. 4	HN-407			FN-6653	FN-4443
TRUCK	96.10 ~ 99. 4	HN-407			FN-6653	FN-4443
REFUSE VEHICLES AT	96.10 ~ 99. 4	HN-349	FN-6653			FN-4443
FE638 1.5t,2t	93.10 ~ 99. 4	HN-349	FN-6653		FN-6602	FN-4443
3t,3.5t,4t	93.10 ~ 99. 4	HN-407	FN-6653		FN-6653	FN-4443
FE648	93.10 ~ 99. 4	HN-407	※		※	FN-4443
※FRONT DRUM BREAD 75mm=FN-6653,110mm=FN-6722 ※REAR DRUM BREAD 75mm=FN-6653,110mm=FN-6722						
FE658, FE659	95. 3 ~ 96.11		FN-3366			FN-4443
	96.11 ~ 99. 4		FN-6722		FN-6722	FN-4443
FE668 1.5t,2t	96.10 ~ 99. 4	HN-349			※	FN-4443

MITSUBISHI - 8

Model 車種形式		Year 年式	Front フロント		Rear リア		Parking パーキング
			Pad パッド	Shoe シュー	Pad パッド	Shoe シュー	Shoe シュー
CANTER							
4600	FE668 3t,3.5t,4t	96.10 ~ 99.4	HN-407	※		※	FN-4443
※FRONT DRUM BREAD 75mm=FN-6653,110mm=FN-6722 ※REAR DRUM BREAD 60mm=FN-6602,75mm=FN-6653,110mm=FN-6722							
	FG508 BD1,B1 series	96.10 ~ 99.4	HN-349			FN-6602	FN-4443
	EXCEPT ABOVE	96.10 ~ 99.4	HN-349			FN-6722	FN-4443
	FG538,FG638	93.10 ~ 99.4		FN-6653		FN-6653	FN-4443
4900	FE63D VAN	99.5 ~ 02.5	HN-349			FN-6602	FN-4443
	TRUCK	99.5 ~ 02.5	HN-407	FN-6653		FN-6653	FN-4443
	FE70D B0・1・4・8 series	04.2 ~	HN-514			FN-6602	FN-4466
	B3・6 series	04.2 ~	HN-513			FN-6653	FN-4466
	FE71D BD1・4 series	04.2 ~	HN-514		HN-514	FN-6602	FN-4466
	BD3・6 series	04.2 ~	HN-513			FN-6653	FN-4466
	FE72D B,C,E1・4,EV1・4 series	04.2 ~	HN-514			FN-6602	FN-4466
	E3・6,EV3・6 series	04.2 ~	HN-513			FN-6653	FN-4466
	FE73D	04.2 ~	HN-513	FN-6653	HN-513	FN-6653	FN-4466
		04.2 ~	HN-513	FN-6722	HN-513	FN-6722	FN-4466
	FE78D	04.2 ~ 09.4	HN-514			FN-6602	FN-4466
	FE82D EV1・4,E1・4,G1・4 series HIGH FLOOR	02.5 ~ 09.4	HN-514		HN-514	FN-6602	FN-4443
	EV3・6,EX3,E3・6, G3・6 series FULL LOW FLOOR	02.5 ~ 09.4	HN-513		HN-513	FN-6653	FN-4443
	FE83D 2t,3t	02.5 ~ 09.4	HN-513	FN-6653		FN-6653	FN-4443
		09.5 ~		FN-6653		FN-6653	FN-4443
	FE88D EV13 series	04.4 ~ 09.4	HN-514			FN-6602	FN-4466
	EV33 series	04.4 ~ 09.4	HN-513			FN-6653	FN-4466
	FF63D	99.5 ~ 02.6		FN-6722		FN-6602	FN-4443
	FF83D	02.5 ~ 09.4		FN-6722		FN-6602	FN-4443
	FG70D B1,BD1 series	04.7 ~	HN-514			FN-6602	FN-4443
	B3,BD3,C3 series	04.7 ~	HN-513			FN-6653	FN-4443
	FG72D C1,E1 series	04.7 ~ 09.4	HN-514			FN-6602	FN-4443
	B3,C3 series	04.7 ~ 09.4	HN-513			FN-6653	FN-4443
	FG73D,FG83D	04.7 ~		FN-6653		FN-6653	FN-4443
	FG82D,FG88D	04.7 ~ 09.4	HN-514			FN-6602	FN-4443
5200	FE512	97.10 ~ 99.4	HN-349			FN-6602	FN-4443
	FE532 W/O PTO	97.10 ~ 99.4	HN-349			FN-6602	FN-4443
	W/ PTO	97.10 ~ 99.4	HN-407			FN-6653	FN-4443
	FE542	97.10 ~ 99.4		FN-6653		FN-6653	FN-4443
	FE562 EV1・4 series	97.10 ~ 99.4	HN-349			※	FN-4443
	B1・3・4・6,C1・3・4 series	97.10 ~ 99.4	HN-407			※	FN-4443
※REAR DRUM BREAD 60mm=FN-6602,75mm=FN-6653,110mm=FN-6722							
	FE632 FRONT DRUM	97.10 ~ 99.4		FN-6653		FN-6653	FN-4443
	C1,G1・4 series	97.10 ~ 99.4	HN-349			FN-6602	FN-4443
	C6,G3・6 series	97.10 ~ 99.4	HN-407			FN-6653	FN-4443
	FE642	97.10 ~ 99.4		FN-6653		FN-6653	FN-4443
	FE652	97.10 ~ 99.4		FN-6722		FN-6722	FN-4443
	FE662 E1,EV1・4 series	97.10 ~ 99.4	HN-349			FN-6602	FN-4443
	E3,EV3・6 series	97.10 ~ 99.4	HN-407			FN-6653	FN-4443
	FE50E,FE52E	99.5 ~ 02.5	HN-349			FN-6602	FN-4443
	FE51E	99.5 ~ 00.6	HN-349			FN-6602	FN-4443
	BD1,4 series	00.6 ~ 02.5	HN-349			FN-6602	FN-4443

NISSAN

TOYOTA
(HINO)

MAZDA

ISUZU

HONDA

MITSUBISHI

SUBARU

SUZUKI

DAIHATSU

LEXUS

INFINITY

HYUNDAI

KIA

MITSUBISHI - 9

- NISSAN
- TOYOTA
(HINO)
- MAZDA
- ISUZU
- HONDA
- MITSUBISHI
- SUBARU
- SUZUKI
- DAIHATSU
- LEXUS
- INFINITI
- HYUNDAI
- KIA

Model 車種形式	Year 年式	Front フロント		Rear リア		Parking パーキング
		Pad パッド	Shoe シュー	Pad パッド	Shoe シュー	Shoe シュー
CANTER						
5200 FE51E BD3,6 series	00.6 ~ 02.5	HN-407			FN-6602	FN-4443
FE53E FRONT DRUM	99.5 ~ 02.5		※		※	FN-4443
C1,EV1 series	99.5 ~ 02.5	HN-349			※	FN-4443
B,BD,BX,C6,EV6 series	99.5 ~ 02.5	HN-407			※	FN-4443
※FRONT DRUM BREAD 75mm=FN-6653,110mm=FN-6722 ※REAR DRUM BREAD 60mm=FN-6602,75mm=FN-6653,110mm=FN-6722						
FE59E	99.5 ~ 02.5	HN-349			FN-6602	FN-4443
FE62E	99.5 ~ 02.5	HN-407			FN-6602	FN-4443
FE63E FRONT DRUM	99.5 ~ 02.5		FN-6653		FN-6653	FN-4443
C4,EV1・4 series	99.5 ~ 02.5	HN-349			FN-6653	FN-4443
FE69E C6,E6,G6,EV3・6 series	99.5 ~ 02.5	HN-407		HN-407	FN-6602	FN-4443
FE69E FRONT DRUM	99.5 ~ 02.5		FN-6653		FN-6653	FN-4443
EV11 series	99.5 ~ 02.5	HN-349			FN-6602	FN-4443
EV31 series	99.5 ~ 02.5	HN-407			FN-6653	FN-4443
FE70E B0・1・3・4・8 series	02.5 ~ 04.8	HN-514			FN-6602	FN-4443
B6E series	02.5 ~ 04.8	HN-513			FN-6653	FN-4443
B12,B4E2,BD12 series	02.5 ~ 04.8	HN-514		HN-514		FN-4443
B32,B6E2 series	02.5 ~ 04.8	HN-513		HN-513		FN-4443
FE71E BD1・4 series	02.5 ~ 04.8	HN-514			FN-6602	FN-4443
BD3・6,BD4EA3 series	02.5 ~ 04.8	HN-513			FN-6653	FN-4443
BD4E2 series	02.5 ~ 04.8	HN-514		HN-514		FN-4443
BD32,B6E2 series	02.5 ~ 04.8	HN-513		HN-513		FN-4443
FE72E B,C,E1・4,EV1・4 series	02.5 ~ 04.8	HN-514			FN-6602	FN-4443
E3・6,EV3・6 series	02.5 ~ 04.8	HN-513			FN-6653	FN-4443
E12・42,EV12・42 series	02.5 ~ 04.8	HN-514		HN-514		FN-4443
E32・62,EV32・62 series	02.5 ~ 04.8	HN-513		HN-513		FN-4443
FE73E FRONT DRUM	02.5 ~ 04.8		FN-6653		FN-6653	FN-4443
FRONT DRUM	02.5 ~ 04.8		FN-6722		FN-6722	FN-4443
FRONT DISC	02.5 ~ 04.8	HN-513			FN-6653	FN-4443
FE78E	02.5 ~ 04.8	HN-514			FN-6602	FN-4443
FE82E EV1・4,E1・4,G1・4 series	02.5 ~ 04.8	HN-514		HN-514	FN-6602	FN-4443
C4 series	02.5 ~ 04.8	HN-514		HN-514	FN-6653	FN-4443
EV3・6,E3・6,G3・6 series	02.5 ~ 04.8	HN-513		HN-513	FN-6653	FN-4443
EX3,EX6 series	02.5 ~ 04.8	HN-513		HN-513		FN-4443
FE83E CY,EY,GY series	02.5 ~ 04.8	HN-513			FN-6653	FN-4443
C,EN,GN series	02.5 ~ 04.8		FN-6653		FN-6653	FN-4443
FE88E EV1 series	02.5 ~ 04.8	HN-514			FN-6602	FN-4443
EV3 series	02.5 ~ 04.8	HN-513			FN-6653	FN-4443
FF63E	99.5 ~ 02.6		FN-6722		FN-6602	FN-4443
FF83E	02.5 ~ 04.8		FN-6722		FN-6602	FN-4443
FG50E B1M168,169,B1146,1147 series	99.5 ~ 02.6	HN-349			FN-6722	
EXCEPT ABOVE	99.5 ~ 02.6	HN-349			FN-6602	
FG52E WHEEL BASE ~2750	99.5 ~ 02.6	HN-349			FN-6722	
WHEEL BASE 3350~	99.5 ~ 02.6	HN-349			FN-6602	
FG53E,FG63E	99.12 ~ 02.6		FN-6653		FN-6653	FN-4443
FG62E	99.5 ~ 02.6	HN-407			FN-6602	
FG68E MT	99.5 ~ 02.6	HN-407			FN-6602	FN-4443
FG68E AT	99.5 ~ 02.6	HN-407			FN-6653	FN-4443
FG70E BD1,B1 series	02.5 ~ 04.8	HN-514			FN-6602	FN-4443
BD3,B3 series	02.5 ~ 04.8	HN-513			FN-6653	FN-4443

MITSUBISHI - 10

Model 車種形式	Year 年式	Front フロント		Rear リア		Parking パーキング
		Pad パッド	Shoe シュー	Pad パッド	Shoe シュー	Shoe シュー
CANTER						
5200 FG72E	C1,E1 series	02. 5 ~ 04. 8	HN-514			FN-6602 FN-4443
	B3,C3 series	02. 5 ~ 04. 8	HN-513			FN-6653 FN-4443
FG73E,FG83E		02. 5 ~ 04. 8		FN-6653		FN-6653 FN-4443
FG82E,FG88E		02. 5 ~ 04. 8	HN-514			FN-6602 FN-4443
COLT						
1300 Z21A		04. 9 ~ 05.10	HN-500			FN-6729
Z21A,Z21W		05.10 ~ 12. 8	HN-500			FN-1267
Z22A		04. 9 ~ 12. 8	HN-500			FN-6729
Z25A,Z26A		02.10 ~ 04.10	HN-500			FN-6729
1500 Z23A		04. 9 ~ 05. 9	HN-500			FN-6729
		05.10 ~ 12. 8	HN-500			FN-1267
Z24A		04. 9 ~ 12. 8	HN-500			FN-6729
Z27A		02.10 ~ 04. 8	HN-500			FN-6729
		04. 9 ~ 12. 8				FN-6729
Z27AG	Ver. R RALLIART	06. 5 ~ 12. 8				
Z28A		02.11 ~ 04.10	HN-500	HN-314		FN-6729
Z23W	PLUS	04. 8 ~ 05. 9	HN-500	HN-314		FN-6729
		05.10 ~ 12. 6	HN-500	HN-314		FN-1267
	C02,S3WA	04. 8 ~ 05. 9		HN-314		FN-6729
	C02,S3WA	05.10 ~ 12. 6		HN-314		
Z24W	PLUS	04. 8 ~ 12. 6	HN-500			FN-6729
Z27W	PLUS RALLIART	04.11 ~ 12. 6		HN-314		
Z27WG	PLUS RALLIART	06. 5 ~ 12. 6		HN-314		
SIGMA・RAMDA						
1600 E11		84. 2 ~ 87. 9	HN-115			FN-6674
1800 E12	PATROL	83. 8 ~ 96. 1	HN-158			FN-6669
	LPG	83. 8 ~ 90. 7	HN-158			FN-6682
	LPG	90. 8 ~ 96. 1	HN-285			FN-6687
E13,E13A	SEDAN	83. 8 ~ 90.11	HN-158	HN-284		FN-6669
	HARDTOP	83. 8 ~ 90.11	HN-158	HN-284		FN-6687
E13A		83. 8 ~ 90.11	HN-158			FN-6682
E14		84. 3 ~ 87. 9	HN-158			FN-6669
	INSTRUCTION CAR	84. 3 ~ 87. 9	HN-158			FN-6674
E19		96. 1 ~ 99. 8	HN-285			FN-6687
2000 E15		83. 8 ~ 90.11	HN-158			FN-6669
		83. 8 ~ 86. 9	HN-158	HN-284		
		86. 9 ~ 90.11	HN-173	HN-174		
E15A,E17A		83. 8 ~ 90.11	HN-158			FN-6669
		83. 8 ~ 86. 9	HN-158	HN-110		
		86. 9 ~ 90.11	HN-173	HN-174		
2000 F11A,F12A		90.10 ~ 95. 8	HN-271	HN-174		
2500 F13A		90.10 ~ 93. 9	HN-271	HN-174		
	25V-SE	93.10 ~ 95. 8	HN-233	HN-174		

- NISSAN
- TOYOTA
(HINO)
- MAZDA
- ISUZU
- HONDA
- MITSUBISHI**
- SUBARU
- SUZUKI
- DAIHATSU
- LEXUS
- INFINITY
- HYUNDAI
- KIA

MITSUBISHI - 11

- NISSAN
- TOYOTA
(HINO)
- MAZDA
- ISUZU
- HONDA
- MITSUBISHI**
- SUBARU
- SUZUKI
- DAIHATSU
- LEXUS
- INFINITY
- HYUNDAI
- KIA

Model 車種形式	Year 年式	Front フロント		Rear リア		Parking パーキング
		Pad パッド	Shoe シュー	Pad パッド	Shoe シュー	Shoe シュー
SIGMA・RAMDA						
2500 F13AK PATROL CAR	91. 8 ~ 95. 8	HN-233		HN-174		
F15A	90.10 ~ 95. 1	HN-233		HN-174		
F25A	90.10 ~ 95. 8	HN-233		HN-272		
3000 E18A	83. 8 ~ 86. 9	HN-158		HN-110		
	86. 9 ~ 90.11	HN-173		HN-174		
F17A	90.10 ~ 95. 8	HN-233		HN-174		
F27A	90.10 ~ 95. 1	HN-233		HN-272		
JEEP						
J24, J27	79.11 ~ 99. 6		FN-6616		FN-6616	FN-6615
J36, J37, J44, J47	79.11 ~ 99. 6		FN-6616		FN-6617	FN-6615
J53	79.11 ~ 89.11		FN-6616		FN-6614	FN-6615
	89.11 ~ 99. 6				FN-6614	FN-6615
J54, J56, J57, J59	79.11 ~ 99. 6		FN-6616		FN-6614	FN-6615
J55	79.11 ~ 99. 6				FN-6614	FN-6615
CHARIOT・GRANDIS						
1600 D02W	83. 1 ~ 84. 5	HN-089			FN-6633	
	84. 6 ~ 91. 5	HN-089			FN-6674	
1800 D03W, D05W, D09W MX, MT	83.01 ~ 84.05	HN-089			FN-6633	
MR TURBO	83.01 ~ 84.05	HN-158			FN-6636	
	84. 6 ~ 91. 5	HN-158			FN-6669	
2000 D08W	84. 6 ~ 91. 5	HN-158			FN-6636	
9inch	84. 6 ~ 91. 5	HN-158			FN-6685	
N33W, N43W	W/O ABS 91. 3 ~ 97.10	HN-271			FN-6687	
	W/ ABS 91. 3 ~ 97.10	HN-271		HN-174		
TURBO	95. 4 ~ 97.10	HN-233		HN-174		
N38W, N48W	W/O ABS 92. 6 ~ 97.10	HN-271			FN-6687	
	W/ ABS 92. 6 ~ 97.10	HN-271		HN-174		
2400 N34W, N44W	93. 5 ~ 97.10	HN-271		HN-174		
N84W, N94W	97. 8 ~ 00. 3	HN-419			FN-6723	
	00. 4 ~ 03. 5	HN-548			FN-6723	
NA4W	03. 3 ~ 09. 3	HN-548		HN-450		
3000 N86W, 96W	99.10 ~ 02. 4	HN-419		HN-272		
STARION						
2000 A182, A183, A184, A187	82. 4 ~ 90. 3					
2600 A187	82. 4 ~ 90. 3					
STRADA						
2500 K34T	91. 3 ~ 97. 6	HN-172			FN-6664	
K74T	97. 6 ~ 99.11	HN-233			FN-6718	

MITSUBISHI - 12

Model 車種形式	Year 年式	Front フロント		Rear リア		Parking パーキング
		Pad パッド	Shoe シュー	Pad パッド	Shoe シュー	Shoe シュー
T-BOX						
660 U61W, U62W	98.11 ~ 11.11	HN-453				FN-6729
U63W, U64W RX	98.11 ~ 02. 8	HN-453				FN-6729
DS64W	14. 3 ~ 15. 3	HN-566				FN-9973
DS17W	15. 3 ~	HN-566				
T-BOX WIDE						
1100 U65W, U66W	99. 4 ~ 00.10	HN-453				FN-6723
	W/O ABS 00.11 ~ 01. 5	HN-453				FN-6729
	W/ ABS 00.11 ~ 01. 5	HN-453				FN-6723
CHALLENGER						
2500 K94WG	96. 5 ~ 97. 7	HN-233		HN-391		
2800 K97WG	96. 5 ~ 99. 5	HN-233		HN-391		
3000 K96W	96. 5 ~ 98. 7	HN-233		HN-391		
3500 K99W	97. 8 ~ 01. 8	HN-233		HN-391		
DIAMANTE						
2000 F11A	90. 5 ~ 92. 9	HN-271		HN-174		
F12A	92. 9 ~ 95. 1	HN-271		HN-174		
2500 F13A	90. 5 ~ 95. 1	HN-271		HN-174		
	25V-S, 25V, 25V-SE	92. 9 ~ 95. 1	HN-233	HN-174		
F15A	90. 5 ~ 93.11	HN-233		HN-174		
F25A	90. 5 ~ 95. 1	HN-233		HN-272		
F31A	95. 1 ~ 02. 9	HN-233		HN-174		
F41A	95. 1 ~ 02. 9	HN-233		HN-272		
F34A	02. 9 ~ 05.12	HN-233		HN-174		
3000 F17A	90. 5 ~ 95. 1	HN-233		HN-174		
F27A	90. 5 ~ 95. 1	HN-233		HN-272		
F36A	95. 1 ~ 02. 9	HN-233		HN-174		
F46A, F47A	95. 1 ~ 02. 9	HN-233		HN-272		
F07W STATION WAGON	W/O ABS 92.12 ~ 94. 7	HN-233		HN-272		
STATION WAGON	W/O ABS 94. 8 ~					
STATION WAGON	W/ ABS 92.12 ~	HN-233		HN-272		
F36W STATION WAGON	97. 7 ~ 98.12					
K45 STATION WAGON	92.12 ~ 97. 7					
DION						
1800 CR5W TURBO	02. 4 ~ 05.12	HN-548				FN-6723
2000 CR6W	00. 7 ~ 05.12	HN-271				FN-6723
DION						
2000 CR9W	00. 1 ~ 02. 3	HN-271				FN-6723

NISSAN

TOYOTA
(HINO)

MAZDA

ISUZU

HONDA

MITSUBISHI

SUBARU

SUZUKI

DAIHATSU

LEXUS

INFINITY

HYUNDAI

KIA

MITSUBISHI - 13

- NISSAN
- TOYOTA
(HINO)
- MAZDA
- ISUZU
- HONDA
- MITSUBISHI**
- SUBARU
- SUZUKI
- DAIHATSU
- LEXUS
- INFINITI
- HYUNDAI
- KIA

Model 車種形式	Year 年式	Front フロント		Rear リア		Parking パーキング
		Pad パッド	Shoe シュー	Pad パッド	Shoe シュー	Shoe シュー
DEBONAIR						
2000 S11A	86. 7 ~ 89. 8	HN-173		HN-174	FN-6682	FN-6704
	89. 9 ~ 92. 7	HN-271		HN-174	FN-6687	FN-6704
3000 S12A	86. 7 ~ 89. 8	HN-173		HN-174		FN-6704
DOHC	89. 9 ~ 92. 7	HN-233		HN-174		FN-6704
SOHC	89. 9 ~ 92. 7	HN-271		HN-174		FN-6704
S22A	92. 9 ~ 99.12	HN-233		HN-272		
DEBONAIR						
3000 S22A						
3500 S26A, S27A	92. 9 ~ 99.12	HN-233		HN-272		
DELICA						
1400 P01V	86. 4 ~ 94. 5		FN-6618A		FN-6637	
1600 L063P	86. 4 ~ 94. 5	HN-084			FN-6637	
P02V HIGH FLOOR	86. 4 ~ 94. 5	HN-172			FN-6664	
LOW FLOOR	86. 4 ~ 94. 5	HN-172			FN-6637	
P12V	90. 8 ~ 93. 6	HN-172			FN-6637	
P06V CARGO	94. 5 ~ 99. 8	HN-172			FN-6664	
P02T TRUCK	94. 3 ~ 99. 6	HN-369			FN-6637	
BVM20	11. 9 ~	HN-556			FN-1276	
1800 SK82T, SK82V	99. 9 ~ 04. 2	HN-332			FN-3410	
	04. 3 ~ 10. 9	HN-332			FN-3426	
SK82L, SK82M	02. 8 ~ 04. 3	HN-332			FN-3410	
	04. 3 ~ 10. 9	HN-332			FN-3426	
2000 P03W	86. 4 ~ 99. 8	HN-172			FN-6664	
P23V, P23W	86. 4 ~ 94. 5	HN-172			FN-6686	
PA3V CARGO	94. 3 ~ 99. 4	HN-369			FN-6715	
P03V, P13V	93. 5 ~ 94. 5	HN-172			FN-6637	
P07V, P17V	94. 5 ~ 99. 8	HN-172			FN-6637	
P27V	94. 5 ~ 99. 8	HN-172			FN-6686	
P13T	94. 3 ~ 99. 6	HN-369			FN-6686	
SKF2L, SKF2M	03.12 ~ 04. 2	HN-332			FN-3410	
	04. 3 ~ 10. 9	HN-332			FN-3426	
SKF2T, SKF2V	03.12 ~ 04. 2	HN-332			FN-3410	
	04. 3 ~ 10. 9	HN-332			FN-3426	
SKE6V CARGO SINGLE TYRE	99. 9 ~ 04. 3	HN-376			FN-3406	
SINGLE TYRE	04. 3 ~	HN-376			FN-3425	
DOUBLE TYRES	99. 9 ~ 04. 3	HN-376			FN-3407	
DOUBLE TYRES	04. 3 ~	HN-376			FN-3426	
SKF6M CARGO	03.12 ~ 04. 2	HN-376			FN-3406	
	04. 3 ~ 07. 8	HN-376			FN-3425	
SKF6V CARGO SINGLE TYRE	03.12 ~ 04. 2	HN-376			FN-3406	

MITSUBISHI - 14

Model 車種形式	Year 年式	Front フロント		Rear リア		Parking パーキング
		Pad パッド	Shoe シュー	Pad パッド	Shoe シュー	Shoe シュー
DELICA						
2000 SKF6V	SINGLE TYRE		HN-376			FN-3425
	DOUBLE TYRES		HN-376			FN-3407
	DOUBLE TYRES		HN-376			FN-3426
2200 SK22L, SK22T			HN-332			FN-3410
SK22M, SK22V			HN-332			FN-3410
2400 P04W			HN-172			FN-6664
P24W			HN-172			FN-6686
PA4W	SPACE GEAR		HN-369			FN-6715
PD4W	SPACE GEAR		HN-233	HN-280		
PB4W, PC4W	SPACE GEAR		HN-369			FN-6718
2500 L039P	TRUCK	HIGH FLOOR	86.4 ~ 94.5	HN-084		FN-6664
	TRUCK	LOW FLOOR	86.4 ~ 94.5	HN-084		FN-6637
L039G			88.8 ~ 94.5	HN-172		FN-6664
L069P	TRUCK		86.4 ~ 94.5	HN-084		FN-6637
P05V, P15V		HIGH FLOOR	86.4 ~ 99.8	HN-172		FN-6664
		LOW FLOOR	86.4 ~ 99.8	HN-172		FN-6637
P05W, P15W			86.4 ~ 99.8	HN-172		FN-6664
P25V, P25W			86.4 ~ 99.8	HN-172		FN-6686
P35W, P45V			89.8 ~ 99.8	HN-172		FN-6686
PA5V	CARGO		94.3 ~ 99.4	HN-369		FN-6715
PA5W	SPACE GEAR		94.3 ~ 99.4	HN-369		FN-6715
PB5V			94.3 ~ 99.4	HN-369		FN-6718
PB5W, PC5W	SPACE GEAR		94.3 ~ 99.4	HN-369		FN-6718
PD5V		W/O ABS	94.3 ~ 99.4	HN-369		FN-6721
		W/ ABS	94.3 ~ 99.4	HN-233		FN-6721
P05T	TRUCK		94.3 ~ 99.6	HN-369		FN-6637
P15T	TRUCK		94.3 ~ 99.6	HN-369		FN-6686
P25T	TRUCK	W/O ABS	94.3 ~ 99.6	HN-369		FN-6715
	TRUCK	W/ ABS	94.3 ~ 99.6	HN-233		FN-6715
SK56M			99.9 ~ 03.12	HN-376		FN-3406
SK56V	SINGLE TYRE		99.9 ~ 03.12	HN-376		FN-3406
	DOUBLE TYRES		99.9 ~ 03.12	HN-376		FN-3407
2800 PD8W, PE8W			94.3 ~ 04.10	HN-233	HN-280	
PF8W			94.3 ~ 04.10	HN-233	HN-280	
3000 PB6W			94.3 ~ 99.4	HN-369		FN-6718
PD6W			94.3 ~ 06.12	HN-233	HN-280	
PF6W			94.3 ~ 04.10	HN-233	HN-280	
3500	L031P, L032P, L033P, L034P, L035P, G, L036P, L037G, L038P, G, L063P, L068P, L069P	TRUCK, VAN, WAGON FRONT DRUM	80.5 ~ 94.5		FN-6618A	FN-6637
		TRUCK, VAN, WAGON FRONT DISC	80.5 ~ 86.4			FN-6637
		TRUCK FRONT DISC	86.4 ~ 94.5	HN-084		FN-6637
L068P	TRUCK		80.5 ~ 94.5			FN-6637
			80.5 ~ 94.5			FN-6664

NISSAN

TOYOTA
(HINO)

MAZDA

ISUZU

HONDA

MITSUBISHI

SUBARU

SUZUKI

DAIHATSU

LEXUS

INFINITY

HYUNDAI

KIA

MITSUBISHI - 15

- NISSAN
- TOYOTA
(HINO)
- MAZDA
- ISUZU
- HONDA
- MITSUBISHI**
- SUBARU
- SUZUKI
- DAIHATSU
- LEXUS
- INFINITI
- HYUNDAI
- KIA

Model 車種形式	Year 年式	Front フロント		Rear リア		Parking パーキング
		Pad パッド	Shoe シュー	Pad パッド	Shoe シュー	Shoe シュー
DELICA D:2						
1200 MB15S	11. 3 ~ 15.12	HN-529			FN-9991	
MB36S	15.12 ~	HN-433				
DELICA D:3						
1600 BM20, BVW20	11.10 ~	HN-556			FN-1276	
DELICA D:5						
2000 CV2W	12. 1 ~ 12. 7	HN-548		HN-450		
	12. 7 ~	HN-548		HN-603		
CV1W	12.12 ~	HN-548		HN-603		
2400 CV5W	07. 1 ~ 12. 7	HN-548		HN-450		
	12. 7 ~	HN-548		HN-603		
TRITON						
3500 KB9T	06. 9 ~ 11. 8				FN-6741	
PAJERO						
2000 L041, L046	82. 4 ~ 87. 8	HN-084		HN-152	FN-6664	
	87. 9 ~ 88.08	HN-172		HN-152	FN-6664	
2300 L043, L048	82. 4 ~ 86. 4	HN-084		HN-152	FN-6664	
2400 V21W	96. 4 ~ 99. 9	HN-233		HN-280		
2500 L044, L049	86. 4 ~ 87. 8	HN-084		HN-152	FN-6664	
	87. 9 ~ 91. 4	HN-172		HN-152	FN-6664	
L144G	88. 9 ~ 91. 4	HN-172		HN-152	FN-6664	
L144GW	88. 9 ~ 91. 4	HN-172		HN-152	FN-6664	
L149GW	88. 9 ~ 91. 4	HN-172		HN-152	FN-6664	
V14V, V34V	91. 1 ~ 93. 7	HN-172			FN-6664	
V24C	90.10 ~ 97. 5	HN-233		HN-280		
V24V	91. 1 ~ 93. 7	HN-172		HN-280		
V24W, V24WG	W/O ABS 90.10 ~ 93. 6	HN-172		HN-280		
	W/ ABS 90.10 ~ 97. 5	HN-233		HN-280		
V44W, V44WG	W/O ABS 90.10 ~ 93. 7	HN-172		HN-280		
	W/ ABS 90.10 ~ 93. 7	HN-233		HN-280		
V47WG	95. 7 ~ 96. 5	HN-233		HN-280		
2800 V26C, V46V	93. 7 ~ 99. 9	HN-233		HN-280		
V26W, V26WG	93. 7 ~ 99. 9	HN-233		HN-280		
V46W, 46WG	93. 7 ~ 99. 9	HN-233		HN-280		
3000 L141G	88. 9 ~ 91. 4	HN-172		HN-152	FN-6664	
L146GW	88. 9 ~ 91. 4	HN-172		HN-152	FN-6664	
V23C, 23W, 43W	90.10 ~ 99. 9	HN-233		HN-280		
V63W, V73W	00. 7 ~ 06. 8	HN-414		HN-450		
V83W, V93W	06. 8 ~	HN-414		HN-450		

MITSUBISHI - 16

Model 車種形式	Year 年式	Front フロント		Rear リア		Parking パーキング
		Pad パッド	Shoe シュー	Pad パッド	Shoe シュー	Shoe シュー
PAJERO						
3200 V68W, V78W	99. 6 ~ 04.11	HN-414		HN-450		
V98W	08.10 ~	HN-482		HN-243		
3500 V25C, V25W	93. 7 ~ 99. 9	HN-233		HN-280		
V45W	93. 7 ~ 99. 9	HN-233		HN-280		
V55W	97. 8 ~ 99. 9	HN-414		HN-280		
V65W, V75W	99. 6 ~ 05.11	HN-414		HN-450		
3800 V77W	05.11 ~ 06. 8	HN-414		HN-450		
V87W	06. 8 ~ 11.10	HN-414		HN-450		
V97W	06. 8 ~	HN-482		HN-243		
PAJERO io						
1800 H66W	98. 3 ~ 00. 6	HN-417			FN-6723	
H61W, H71W	99. 8 ~ 00. 6	HN-417			FN-6723	
H76W	98. 5 ~ 07. 5	HN-417			FN-6723	
TURBO	98. 5 ~ 07. 5	HN-417		HN-174		
2000 H62W, H72W	00. 6 ~ 02. 9	HN-417			FN-6723	
H67W	00. 6 ~ 02. 9	HN-417			FN-6723	
H77W	00. 6 ~ 07. 5	HN-417			FN-6723	
PAJERO Jr						
1100 H57A	95.10 ~ 96.11	HN-473			FN-6687	
	96.12 ~ 98. 6	HN-417			FN-6687	
PAJERO MINI						
660 H51A, H56A	94.10 ~ 97. 5	HN-473			FN-6687	
	97. 6 ~ 98.10	HN-417			FN-6687	
H53A, H58A	98. 8 ~ 12. 6	HN-417			FN-6723	
FORTE						
1600 L021P, L025P, L022P	78. 9 ~ 81. 9				FN-6640	
	81. 9 ~				FN-6660	
2600 L026G	78. 9 ~ 81. 9				FN-6640	
	81. 9 ~				FN-6660	
PROUDIA・DIGNITY						
2500 BY51	12. 7 ~	HN-444		HN-565		
3500 S32A	00. 2 ~ 01. 5	HN-414		HN-272		
BHGY51, BGY51	12. 7 ~	HN-444		HN-565		
3700 BKY51, BKNY51	12. 7 ~ 14. 3	HN-444		HN-565		
4500 S33A, S43A	00. 2 ~ 01. 5	HN-414		HN-272		

- NISSAN
- TOYOTA
(HINO)
- MAZDA
- ISUZU
- HONDA
- MITSUBISHI**
- SUBARU
- SUZUKI
- DAIHATSU
- LEXUS
- INFINITY
- HYUNDAI
- KIA

MITSUBISHI - 17

Double-lined items are discontinued.

- NISSAN
- TOYOTA
(HINO)
- MAZDA
- ISUZU
- HONDA
- MITSUBISHI
- SUBARU
- SUZUKI
- DAIHATSU
- LEXUS
- INFINITI
- HYUNDAI
- KIA

Model 車種形式	Year 年式	Front フロント		Rear リア		Parking パーキング
		Pad パッド	Shoe シュー	Pad パッド	Shoe シュー	Shoe シュー
MAGNA						
2600 TP4	91.10 ~	HN-158				
MINICA						
550 H11A, H11V, H12A, H12V, H14A, H14V, H15A, H15V	84. 1 ~ 89. 1	HN-115	FN-6678		FN-6670	
660 H21A, H21V, H22A, H22V	88.11 ~ 95.10	HN-244	FN-6710		FN-6707	
H22VW	88.11 ~ 95.10	HN-244	FN-6710		FN-6707	
H26A, H26V, H27A, H27V	88.11 ~ 95.10	HN-244	FN-6710		FN-6707	
H27VW	88.11 ~ 95.10	HN-244	FN-6710		FN-6707	
H31A, H32A	88.11 ~ 98.11	HN-244	FN-6710		FN-6707	
H32V, H37V	88.11 ~ 98.11	HN-244	FN-6710		FN-6707	
H36A PG, PX, ST	88.11 ~ 98.11	HN-244	FN-6710		FN-6707	
DANGAN	93. 9 ~ 98.11	HN-244		HN-373		
H42A, H47A	98.10 ~ 07. 7	HN-453			FN-6726	
H42V, H47V	98. 8 ~ 00.10	HN-453			FN-6726	
	W/O ABS 00.11 ~ 11. 6	HN-437			FN-6726	
	W/ ABS 00.11 ~ 11. 6	HN-453			FN-6726	
1100 H44A	98. 8 ~ 11. 6	HN-453			FN-6726	
MINICA TOPPO						
660 H31AH, H36AH	88.11 ~ 98.10	HN-244	FN-6710		FN-6707	
H32VH, H37VH	88.11 ~ 98.10	HN-244	FN-6710		FN-6707	
H41A, H46A	98.10 ~ 02. 7	HN-453			FN-6726	
H42A, H47A	98.10 ~ 03. 7	HN-453			FN-6726	
H42V, H47V	00. 1 ~ 00.12	HN-453			FN-6726	
	W/O ABS 01. 1 ~ 03. 7	HN-437			FN-6726	
	W/ ABS 01. 1 ~ 03. 7	HN-453			FN-6726	
H82A TURBO	08. 9 ~ 13. 6	HN-453			FN-6726	
	08. 9 ~ 13. 6	HN-437			FN-6726	
TOPPO BJ WIDE						
1100 H43A, H48A	98.11 ~ 01. 5	HN-453			FN-6726	
PISTACHIO						
1100 H44A	98. 8 ~ 00. 3	HN-453			FN-6726	
MINICAB・BRAVO						
550 L015P	82. 8 ~ 84. 4		FN-6649		FN-6651	
L015G	82. 8 ~ 84. 4		FN-6649		FN-6657	
U11T, U11TP, U11V	84. 4 ~ 87. 5		FN-6678		FN-6770	
	84. 4 ~ 87. 5	HN-115			FN-6657	
U12T, U12V	84. 4 ~ 87. 5	HN-115			FN-6609	
U14T, U14TP, U14V	87. 6 ~ 91. 2		FN-6678		FN-6770	
	87. 6 ~ 91. 2	HN-115			FN-6657	
U14TG, U14VG	87. 6 ~ 91. 2	HN-115			FN-6657	
U15T, U15V, U15TG, U15VG	87. 6 ~ 91. 2	HN-115			FN-6609	
660 U18T, U18V, U18TP	90. 1 ~ 91. 2	HN-115			FN-6657	

MITSUBISHI - 18

Model 車種形式	Year 年式	Front フロント		Rear リア		Parking パーキング
		Pad パッド	Shoe シュー	Pad パッド	Shoe シュー	Shoe シュー
MINICAB・BRAVO						
660 U18T, U18V, U18TP	90. 1 ~ 91. 2		FN-6678		FN-6707	
U19T, U19V	90. 1 ~ 91. 2	HN-115			FN-6609	
U41T FRONT DRUM	91. 1 ~ 99. 8		FN-6710		FN-6707	
U41T, U42T	91. 1 ~ 95. 1	HN-311			FN-6707	
	95. 1 ~ 99. 8	HN-379			FN-6707	
U41V, U42V	91. 1 ~ 95. 1	HN-311			FN-6707	
	95. 1 ~ 99. 8	HN-379			FN-6707	
U41TP, U42TP	91. 1 ~ 95. 1	HN-311			FN-6707	
	95. 1 ~ 99. 8	HN-379			FN-6707	
U43V, U44V	93.12 ~ 95. 1	HN-311			FN-6707	
	95. 1 ~ 99. 8	HN-379			FN-6707	
U61T, U62T	98.11 ~ 14. 2	HN-437			FN-6729	
U61TP, U62TP	98.11 ~ 14. 2	HN-437			FN-6729	
U61V, U62V	98.11 ~ 14. 2	HN-437			FN-6729	
DS16T	14. 2 ~	HN-566			FN-9966	
DS64V	14. 3 ~ 15. 3	HN-566				
DS17V	15. 3 ~	HN-566				
MIRAGE						
1000 A05A	12. 8 ~	HN-453				
A03A	14.12 ~	HN-453				
1300 C11A, C11V	83.10 ~ 88. 1	HN-089			FN-6670	
	88. 1 ~ 92. 9	HN-285			FN-6707	
C51A, C61A	87. 1 ~ 89. 9	HN-089			FN-6670	
	89. 9 ~ 91.10	HN-285			FN-6707	
CA1A, CB1A	W/O ABS 91.10 ~ 96. 1	HN-285			FN-6712	
	W/ ABS 91.10 ~ 96. 1	HN-285		HN-314		
CJ1A, CK1A	95. 8 ~ 96. 8	HN-285			FN-6712	
	96. 8 ~ 00. 8	HN-285			FN-6701	
CQ1A DINGO	00. 1 ~ 00.12	HN-271			FN-6729	
	00.12 ~ 02. 8	HN-462			FN-6729	
1500 C12A, C12V, C12W	83.10 ~ 88. 1	HN-089			FN-6670	
	88. 1 ~ 92. 9	HN-285			FN-6701	
C32V	86. 8 ~ 89. 9	HN-158			FN-6636	
	89.10 ~ 92. 9	HN-285			FN-6701	
C52A, C62A	87. 1 ~ 89. 9	HN-089			FN-6670	
	89. 9 ~ 91.10	HN-285			FN-6670	
C72A	87. 1 ~ 89. 9	HN-158			FN-6636	
C72A, C82A	89. 9 ~ 91.10	HN-285			FN-6701	
CA2A	W/O ABS 91.10 ~ 95.10	HN-286			FN-6712	
	W/ ABS 91.10 ~ 95.10	HN-285		HN-314		
CA3A, CB2A	W/O ABS 91.10 ~ 96. 1	HN-285			FN-6712	
	W/ ABS 91.10 ~ 96. 1	HN-285		HN-314		
CB3A	W/O ABS 91.10 ~ 95.10	HN-285			FN-6712	
	W/ ABS 91.10 ~ 95.10	HN-285		HN-314		
CC3A, CD3A	W/O ABS 91.10 ~ 95.10	HN-285			FN-6687	
	W/ ABS 91.10 ~ 95.10	HN-285		HN-314		

- NISSAN
- TOYOTA (HINO)
- MAZDA
- ISUZU
- HONDA
- MITSUBISHI**
- SUBARU
- SUZUKI
- DAIHATSU
- LEXUS
- INFINITY
- HYUNDAI
- KIA

MITSUBISHI - 19

- NISSAN
- TOYOTA
(HINO)
- MAZDA
- ISUZU
- HONDA
- MITSUBISHI**
- SUBARU
- SUZUKI
- DAIHATSU
- LEXUS
- INFINITI
- HYUNDAI
- KIA

Model 車種形式	Year 年式	Front フロント		Rear リア		Parking パーキング
		Pad パッド	Shoe シュー	Pad パッド	Shoe シュー	Shoe シュー
MIRAGE						
1500 CJ2A, CK2A	W/O ABS	95. 8 ~ 96. 8	HN-285			FN-6712
	W/O ABS	96. 9 ~ 00. 8	HN-285			FN-6701
	W/ ABS	95. 8 ~ 96. 8	HN-285		HN-314	
	W/ ABS	96. 8 ~ 00. 8	HN-285		HN-314	FN-6701
CL2A, CM2A	W/O ABS	95. 8 ~ 97. 7	HN-285			FN-6687
	W/O ABS	97. 7 ~ 00. 8	HN-285			FN-6723
	W/ ABS	95. 8 ~ 00. 8	HN-285		HN-314	
CQ2A	DINGO	98.11 ~ 00.11	HN-271			FN-6729
		00.12 ~ 02. 8	HN-462			FN-6729
	4WD	99.12 ~ 00.11	HN-271			FN-6723
		00.12 ~ 02. 8	HN-462			FN-6723
1600 C53A, C63A		87. 1 ~ 89. 9	HN-158		HN-110	
		89. 9 ~ 91.10	HN-271		HN-284	
C73A		87. 1 ~ 89. 9	HN-158		HN-312	
C73A, C83A		89. 9 ~ 91.10	HN-271		HN-312	
CA4A, CB4A		91.10 ~ 96. 1	HN-271		HN-314	
CB6A, CC4A		91.10 ~ 95.12	HN-271		HN-314	
CJ4A	ZR, RX, R	95. 8 ~ 00. 8	HN-271		HN-314	
	RS	95. 8 ~ 00. 8	HN-233		HN-314	
CK4A		95. 8 ~ 00. 8	HN-271		HN-314	
1800 C14A, C14V, C14W		85. 1 ~ 88. 1	HN-089			FN-6670
		88. 1 ~ 92. 9	HN-285			FN-6701
C18A		86. 5 ~ 88. 1	HN-089			FN-6670
C34V, C34W, C37W		86. 8 ~ 89. 9	HN-158			FN-6636
		89.10 ~ 92. 9	HN-285			FN-6701
C64A		87. 1 ~ 89. 9	HN-089			FN-6670
		89. 9 ~ 91.10	HN-285			FN-6707
C74A		87. 1 ~ 89. 9	HN-158			FN-6636
		89. 9 ~ 91.10	HN-285			FN-6701
CB7A		91.10 ~ 92.10	HN-285			FN-6712
CD7A		91.10 ~ 92.10	HN-285			FN-6687
CB5AR	INSTRUCTION CAR	92.10 ~ 96.10	HN-285			FN-6701
CD5A		91.10 ~ 95.10	HN-271		HN-314	
CM5A, CK6A		95. 8 ~ 00. 8	HN-271		HN-314	
CQ5A	DINGO	00. 2 ~ 00.11	HN-271			FN-6729
		00.12 ~ 02. 8	HN-462			FN-6729
2000 CB8A		92.10 ~ 95.10	HN-285		HN-314	FN-6712
CD8A		92.10 ~ 95.10	HN-285		HN-314	FN-6687
CK8A	W/O ABS	95. 8 ~ 96. 8	HN-285			FN-6712
	W/O ABS	96. 9 ~ 99. 6	HN-285			FN-6701
	W/ ABS	95. 8 ~ 99. 6	HN-285		HN-314	
CM8A	W/O ABS	95. 8 ~ 97. 7	HN-285			FN-6687
	W/O ABS	97. 7 ~ 99. 6	HN-285			FN-6723
	W/ ABS	95. 8 ~ 99. 6	HN-285		HN-314	

MITSUBISHI - 20

Model 車種形式	Year 年式	Front フロント		Rear リア		Parking パーキング
		Pad パッド	Shoe シュー	Pad パッド	Shoe シュー	Shoe シュー
LANCER						
1200 A171, A172, A174	79. 0 ~ 87.10	HN-066				FN-6636
A175	79. 0 ~ 87.10	HN-066				
	TURBO, W/O INTERCOOLER	HN-158				FN-6646
	TURBO, W/ INTERCOOLER	HN-158				
CVAY12	08.12 ~ 07. 1	HN-452				FN-1264
1300 C11A	83.10 ~ 88. 6	HN-089				FN-6670
C11V	85. 1 ~ 89. 9	HN-089				FN-6669
	89.10 ~ 92. 9	HN-285				FN-6701
C61A	88. 5 ~ 89. 9	HN-089				FN-6670
	89.10 ~ 91.10	HN-285				FN-6707
CB1A	W/O ABS	HN-285				FN-6712
	W/ ABS	HN-285		HN-314		
	W/O ABS	HN-285				FN-6712
CK1A	W/ ABS	HN-285				FN-6701
1400 A172A	79. 0 ~ 87.10	HN-066				FN-6636
1500 C12A	83.10 ~ 88. 6	HN-089				FN-6670
C12V, C12W	85. 1 ~ 89. 9	HN-089				FN-6669
	89.10 ~ 92. 9	HN-285				FN-6701
C32V	85. 1 ~ 89. 9	HN-158				FN-6636
	89.10 ~ 92. 9	HN-285				FN-6701
C62A	88. 5 ~ 89. 9	HN-089				FN-6670
	89.10 ~ 91.10	HN-285				FN-6707
C72A	88. 5 ~ 89. 9	HN-158				FN-6636
	89. 9 ~ 91.10	HN-285				FN-6701
CB2A, CB3A	W/O ABS	HN-285				FN-6712
	W/ ABS	HN-285		HN-314		
CC3A, CD3A	W/O ABS	HN-285				FN-6687
	W/ ABS	HN-285		HN-314		
CK2A	W/O ABS	HN-285				FN-6712
	W/ ABS	HN-285		HN-314		
CM2A	W/O ABS	HN-285				FN-6687
	W/O ABS	HN-285				FN-6723
	W/ ABS	HN-285		HN-314		
CS2A	CDE1A	HN-462				FN-6729
		HN-462				FN-6729
	MX TOURING	HN-462				FN-6723
CS2V		HN-435				FN-6723
CS2W		HN-462				FN-6729
CVY12		HN-452				FN-1264
1600 A174A	79. 0 ~ 87.10	HN-066				FN-6636
C13A	83.10 ~ 88. 6	HN-158				FN-6674
C18A	83.10 ~ 88. 6	HN-089				FN-6670
C63A	88. 5 ~ 89. 9	HN-158		HN-110		
	89. 9 ~ 91.10	HN-271		HN-284		
C73A	88. 5 ~ 89. 9	HN-153		HN-312		
	89. 9 ~ 91.10	HN-271		HN-312		
CB4A, CB6A	92.10 ~ 95.10	HN-271		HN-314		
CK4A	95. 8 ~ 00. 5	HN-271		HN-314		

- NISSAN
- TOYOTA
(HINO)
- MAZDA
- ISUZU
- HONDA
- MITSUBISHI**
- SUBARU
- SUZUKI
- DAIHATSU
- LEXUS
- INFINITY
- HYUNDAI
- KIA

MITSUBISHI - 21

- NISSAN
- TOYOTA
(HINO)
- MAZDA
- ISUZU
- HONDA
- MITSUBISHI**
- SUBARU
- SUZUKI
- DAIHATSU
- LEXUS
- INFINITI
- HYUNDAI
- KIA

Model 車種形式	Year 年式	Front フロント		Rear リア		Parking パーキング
		Pad パッド	Shoe シュー	Pad パッド	Shoe シュー	Shoe シュー
LANCER						
1600 CVZNY12	08.11 ~	HN-452			FN-1264	
1800 A175A	79. 0 ~ 87.10	HN-066				
TURBO, W/O INTERCOOLER	79. 0 ~ 87.10	HN-158			FN-6646	
TURBO, W/ INTERCOOLER	79. 0 ~ 87.10					
C14A	83.10 ~ 88. 6	HN-089			FN-6670	
C14V, C14W	85. 1 ~ 89. 9	HN-089			FN-6669	
	89.10 ~ 92.10	HN-285			FN-6701	
C34V, C34W, C37W	85. 1 ~ 89. 9	HN-158			FN-6636	
	89.10 ~ 92. 9	HN-285			FN-6701	
C64A	88. 5 ~ 89. 9	HN-089			FN-6670	
	89. 9 ~ 91.10	HN-285			FN-6707	
C74A	88. 5 ~ 89. 9	HN-158			FN-6636	
	89. 9 ~ 91.10	HN-285			FN-6701	
CB7A	91.10 ~ 92.10	HN-285			FN-6712	
CD7A	91.10 ~ 92.10	HN-285			FN-6687	
CD5A	91.10 ~ 95.10	HN-271		HN-314		
CB5AR INSTRUCTION CAR	92.10 ~ 96.10	HN-285			FN-6701	
CM5A, CK6A	95. 8 ~ 00. 5	HN-271		HN-314		
CK5AR INSTRUCTION CAR	96. 7 ~ 00. 5	HN-285			FN-6701	
CS5A CDEIA TOURING	00. 3 ~ 05.12	HN-462			FN-6729	
SE-G	03. 2 ~ 04.11	HN-462			FN-6729	
SE-G	04.12 ~ 05. 1	HN-548			FN-6729	
RALLIART	03.11 ~ 04.11	HN-462		HN-502	FN-6729	
RALLIART	04.12 ~ 08. 6	HN-548		HN-502	FN-6729	
CS5AR INSTRUCTION CAR	01. 9 ~ 05.12	HN-462			FN-6729	
CS5AZ INSTRUCTION CAR	05.12 ~ 07. 8	HN-462			FN-6729	
CS5W CDEIA TOURING 2WD	00.10 ~ 03. 2	HN-462			FN-6729	
4WD	00.10 ~ 03. 2	HN-462			FN-6723	
TURBO	01. 5 ~ 03. 2	HN-548		HN-502		
TOURING	03. 2 ~ 08. 6	HN-548		HN-502		
RALLIART	04. 1 ~ 08. 6	HN-548		HN-502		
CVJY12	08.11 ~	HN-452			FN-1264	
2000 C13A	83.10 ~ 88. 6	HN-158			FN-6674	
CB8A	92.10 ~ 96.10	HN-285		HN-314	FN-6712	
CB8AR INSTRUCTION CAR	92.10 ~ 96.10	HN-285			FN-6701	
CD8A	92.10 ~ 96.10	HN-285		HN-314	FN-6687	
CD9A	92.10 ~ 94. 1	HN-233		HN-314		
CE9A	94. 1 ~ 96.10	HN-233		HN-314		
CK8A W/O ABS	95. 8 ~ 96. 8	HN-285			FN-6712	
W/O ABS	96. 9 ~ 99. 6	HN-285			FN-6701	
W/ ABS	95. 8 ~ 99. 6	HN-285		HN-314		
CK8AR INSTRUCTION CAR	96. 9 ~ 99. 7	HN-285			FN-6701	
CM8A W/O ABS	95. 8 ~ 97. 7	HN-285			FN-6687	
W/O ABS	97. 7 ~ 99. 6	HN-285			FN-6723	
W/ ABS	95. 8 ~ 99. 6	HN-285		HN-314		
CN9A	96. 8 ~ 97. 8	HN-233		HN-272		
CP9A RS	98. 1 ~ 00. 5	HN-233		HN-272		

MITSUBISHI - 22

Model 車種形式		Year 年式	Front フロント		Rear リア		Parking パーキング
			Pad パッド	Shoe シュー	Pad パッド	Shoe シュー	Shoe シュー
LANCER							
2000	CP9A	brembo					
	CT9A	RS					
		brembo					
	CS6A						
	CT9W	brembo					
	CZ4A	EVOLUTION RS					
		EVOLUTION GSR					
LIBERO・LIBERO CARGO							
1300	CB1V						
		W/O ABS					
		W/ ABS					
1500	CB2V						
		W/O ABS					
		W/ ABS					
	CD2V						
	CB2W						
		W/O ABS					
		W/ ABS					
1600	CB4W						
1800	CB5W						
		W/O ABS					
		W/ ABS					
	CD5W						
		TURBO					
2000	CB8V, CB8W						
		W/O ABS					
		W/ ABS					
	CD8V						
	CD8W						
LEGNUM							
1800	EA1W						
	EC1W						
2000	EA4W						
	EC4W						
	EA7W						
	EC7W						
2400	EA3W, EC3W						
2500	EA5W						
	EC5W						
		VR-4					
ROSA							
3300	BH214F						

NISSAN

TOYOTA
(HINO)

MAZDA

ISUZU

HONDA

MITSUBISHI

SUBARU

SUZUKI

DAIHATSU

LEXUS

INFINITY

HYUNDAI

KIA

MITSUBISHI - 23

- NISSAN
- TOYOTA
(HINO)
- MAZDA
- ISUZU
- HONDA
- MITSUBISHI**
- SUBARU
- SUZUKI
- DAIHATSU
- LEXUS
- INFINITI
- HYUNDAI
- KIA

Model 車種形式	Year 年式	Front フロント		Rear リア		Parking パーキング
		Pad パッド	Shoe シュー	Pad パッド	Shoe シュー	Shoe シュー
ROSA						
3300 BE434	DRUM				FN-6653	FN-6681
	DISC					FN-6653 FN-6681
3600 BE435E	SHORT BODY	87.4 ~ 89.10	HN-175			FN-6668 FN-6600
	LONG BODY	87.4 ~ 89.10	HN-175			FN-6653 FN-6600
		89.10 ~ 91.9	HN-175			FN-6668 FN-6600
		91.10 ~ 93.10	HN-348			FN-6668 FN-6600
BE435F	K,KA,MK series	89.10 ~ 93.10	HN-349			FN-6653 FN-6600
	MKA,MKH,S series	89.10 ~ 93.10	HN-349			FN-6653 FN-6600
	W/O THE ABOVE	89.10 ~ 91.9	HN-175			FN-6653 FN-6600
	W/O THE ABOVE	91.10 ~ 93.10	HN-348			FN-6653 FN-6600
BE436E	W/O ABS	86.1 ~ 95.3	HN-348			FN-6668 FN-6600
	W/ ABS	86.1 ~ 95.3	HN-349			FN-6653 FN-6600
	MT	95.4 ~ 97.11	HN-349			FN-6653 FN-4443
	AT	95.4 ~ 97.11	HN-407			FN-6653 FN-4443
BE436F		93.10 ~ 95.5	HN-349			FN-6653 FN-6600
BE636	MT	97.8 ~ 99.4	HN-349			FN-6653 FN-4443
	AT	97.8 ~ 99.4	HN-407			FN-6653 FN-4443
3900 BE439, BE449		89.10 ~ 95.3	HN-349			FN-6653 FN-6681
		95.4 ~ 97.11	HN-407			FN-6653 FN-4443
		89.10 ~ 95.3	HN-349			FN-6653 FN-6681
		95.4 ~ 97.9	HN-407			FN-6653 FN-4443
4200 BE437	LONG BODY	89.10 ~ 95.3	HN-349			FN-6653 FN-6681
	SHORT BODY	89.10 ~ 95.3	HN-348			FN-6668 FN-6681
BG437		89.10 ~ 95.3		FN-6653		FN-6653 FN-6681
BE63C	EDH,EM series	99.4 ~	HN-349			FN-6653 FN-4443
	GD,GM series	99.4 ~	HN-407			FN-6653 FN-4443
4600 BE438E, BE438F		95.5 ~ 97.9	HN-349			FN-6653 FN-4443
		95.5 ~ 97.9	HN-407			FN-6653 FN-4443
BG438		95.5 ~ 97.9		FN-6653		FN-6653 FN-4443
4900 BE644, BE654		97.8 ~ 99.4	HN-407			FN-6653 FN-4443
	DRUM	99.4 ~				FN-4443
	DISC	99.4 ~	HN-407			FN-6653 FN-4443
BE64D		99.4 ~	HN-407			FN-6653 FN-4443
	SUPER LONG BODY	01.4 ~ 04.9	HN-407			FN-6722 FN-4443
	SUPER LONG BODY	04.9 ~	HN-407			FN-4443
BE66D		99.4 ~	HN-407			FN-6653 FN-4443
5200 BG642, BE642G		97.8 ~ 99.4	HN-407			FN-6653 FN-4443
		97.8 ~ 99.4	HN-407			FN-6722 FN-4443
BE642J		97.8 ~ 99.4	HN-407			FN-6722 FN-4443
BE632	EDM,EMH series	97.8 ~ 99.4	HN-349			FN-6653 FN-4443
	GK,GM series	97.8 ~ 99.4	HN-407			FN-6653 FN-4443
		97.8 ~ 99.4		FN-6722		FN-6722 FN-4443
BG64E		99.4 ~	HN-407			FN-6653 FN-4443
BE63E	EM,GM series	99.4 ~	HN-407			FN-6653 FN-4443
	EDH,EMH,EMK series	99.4 ~	HN-349			FN-6653 FN-4443
		99.4 ~		FN-6722		FN-6722 FN-4443
BE64EG		99.4 ~	HN-407			FN-6653 FN-4443
BE64EJ		99.4 ~	HN-407			FN-6722 FN-4443

SUBARU - 1

Model 車種形式	Year 年式	Front フロント		Rear リア		Parking パーキング
		Pad パッド	Shoe シュー	Pad パッド	Shoe シュー	Shoe シュー
R1						
660 RJ1, RJ2	05. 1 ~ 10. 4	HN-426				FN-7756
R2						
660 RC1, RC2	03.10 ~ 10. 4	HN-426				FN-7756
ALCYONE SVX						
1800 AX4, AX7	85. 6 ~ 91. 8	HN-153				
2700 AX9	87. 7 ~ 91. 8	HN-153				
3300 CXD, CXW	91. 9 ~ 96.11	HN-137		HN-249		
IMPREZA						
1500 GC1	W/O ABS	92.11 ~ 00. 7	HN-248			FN-7744
	W/ ABS	92.11 ~ 96. 8	HN-248		HN-249	
	W/ ABS	96. 9 ~ 00. 7	HN-398			FN-7747
RETNA	W/O ABS	94. 9 ~ 97. 8	HN-248		HN-249	
	W/ ABS	96. 9 ~ 97. 8	HN-398		HN-249	
GC2	W/O ABS	96. 9 ~ 00. 7	HN-248			FN-7744
	W/ ABS	96. 9 ~ 00. 7	HN-398			FN-7747
RETNA	W/O ABS	96. 9 ~ 97. 8	HN-248		HN-249	
	W/ ABS	96. 9 ~ 97. 8	HN-398		HN-249	
GF1		94. 9 ~ 96. 8	HN-248			FN-7744
	CZ-SPORT	99. 8 ~ 00. 7	HN-398			FN-7747
GF1, GF2	W/O ABS	96. 9 ~ 00. 7	HN-248			FN-7744
	W/ ABS	96. 9 ~ 00. 7	HN-398			FN-7747
GG2, GG3	I 'S SELECT	00. 2 ~ 02.10	HN-398			FN-7747
	15I	02. 9 ~ 07. 5	HN-493			FN-7747
	15I-S	04. 3 ~ 06. 6	HN-460			FN-7747
GD2, GD3		03. 6 ~ 07. 5	HN-493			FN-7747
GDC, GDD		06. 4 ~ 07. 5	HN-493			FN-7747
GGC, GGD	S PACKAGE	06. 4 ~ 07. 5	HN-460			
		06. 4 ~ 07. 5	HN-493			FN-7747
S PACKAGE		06. 4 ~ 07. 5	HN-460			
		06. 4 ~ 07. 5	HN-493			FN-7747
1600 GC4, GF3	W/O ABS	92.11 ~ 96. 8	HN-248			FN-7744
	W/ ABS	92.11 ~ 96. 8	HN-248		HN-249	
		93.10 ~ 96. 8	HN-248			FN-7744
GF4	W/O ABS	93.10 ~ 96. 8	HN-248			FN-7744
	W/ ABS	93.10 ~ 96. 8	HN-248		HN-249	
1800 GC6	W/O ABS	92.11 ~ 96. 8	HN-248			FN-7744
	W/ ABS	92.11 ~ 96. 8	HN-248		HN-249	
		96. 9 ~ 00. 7	HN-398			FN-7744
GF5	W/O ABS	96. 9 ~ 00. 7	HN-398			FN-7747
	W/ ABS	96. 9 ~ 00. 7	HN-398			FN-7747
GF6	W/O ABS	92.11 ~ 98. 8	HN-398			FN-7744
	W/ ABS	92.11 ~ 98. 8	HN-398		HN-249	FN-7747
	W/O ABS	98. 8 ~ 00. 7	HN-398			FN-7747
W/ ABS	96. 9 ~ 98. 8	HN-398			FN-7747	

- NISSAN
- TOYOTA
(HINO)
- MAZDA
- ISUZU
- HONDA
- MITSUBISHI
- SUBARU**
- SUZUKI
- DAIHATSU
- LEXUS
- INFINITI
- HYUNDAI
- KIA

SUBARU - 2

- NISSAN
- TOYOTA
(HINO)
- MAZDA
- ISUZU
- HONDA
- MITSUBISHI
- SUBARU**
- SUZUKI
- DAIHATSU
- LEXUS
- INFINITI
- HYUNDAI
- KIA

Model 車種形式	Year 年式	Front フロント		Rear リア		Parking パーキング
		Pad パッド	Shoe シュー	Pad パッド	Shoe シュー	Shoe シュー
IMPREZA						
1800 GF6	98. 9 ~ 00. 7	HN-398			FN-7747	
2000 GC8	92.11 ~ 96. 8	HN-247		HN-249		
HX-20S W/O ABS	96. 9 ~ 98. 8	HN-398			FN-7744	
HX-20S W/ ABS	96. 9 ~ 98. 8	HN-398			FN-7747	
WRX	96. 9 ~ 98. 8	HN-390		HN-249		
WRX	98. 9 ~ 00. 7	HN-390		HN-415		
WRX STI	96. 9 ~ 98. 8	HN-463		HN-249		
WRX STI	98. 9 ~ 00. 7	HN-463		HN-415		
WRX RA STI 15 inch	96. 9 ~ 97. 8	HN-390		HN-249		
WRX RA STI 16 inch	96. 9 ~ 97. 8	HN-463		HN-249		
WRX RA STI 16 inch	97. 9 ~ 00. 7	HN-463		HN-221		
GF8 WRX	93.10 ~ 96. 8	HN-247		HN-249		
HX-20S	95.10 ~ 96. 8	HN-248		HN-249		
HX-20S W/O ABS	96. 9 ~ 98. 8	HN-248			FN-7744	
HX-20S W/ ABS	96. 9 ~ 98. 8	HN-248			FN-7747	
HX-20S	96. 9 ~ 98. 8	HN-398		HN-249		
WRX W/O ABS	96. 9 ~ 00. 7	HN-390			FN-7744	
WRX W/ ABS	96. 9 ~ 00. 7	HN-390			FN-7747	
WRX STI	96. 9 ~ 98. 8	HN-463		HN-249		
WRX STI	98. 9 ~ 00. 7	HN-463		HN-415		
GD9 NA	00. 8 ~ 02.10	HN-460		HN-415		
20S	02.11 ~ 03. 8	HN-460				
GDA WRX NB	00. 3 ~ 02.10	HN-460		HN-415		
WRX NBR	01. 6 ~ 02.10	HN-463		HN-221		
WRX	02.11 ~ 08.10	HN-463		HN-221		
GDB STI-PRODRIVE	00. 3 ~ 08.10					
RA STI W/O BREMBO	00. 3 ~ 01. 8	HN-463		HN-221		
RA SPEC-C W/O BREMBO	02. 9 ~ 08.10	HN-463		HN-221		
GG9 20N	00. 3 ~ 02.10	HN-460		HN-415		
20S	02.11 ~ 04. 4	HN-460				
GGA 20K	00. 2 ~ 02.10	HN-460		HN-415		
WRX	02.11 ~ 07. 6	HN-463		HN-221		
GGB WRX STI	00. 4 ~ 14. 7	HN-463		HN-221		
GRB WRX STI	07.10 ~					
VIVIO						
660 KK3, KK4	92. 3 ~ 98. 9	HN-315			FN-7731	
KW3, KW4	92. 3 ~ 98. 9	HN-315			FN-7731	
KY3	93. 5 ~ 95. 9	HN-315			FN-7731	
EXIGA						
2500 YA9	~003831 09. 7 ~ 10. 5	HN-460		HN-501		
SAMBAR						
660 KS3, KS4	90. 3 ~ 92. 9	HN-251			FN-7743	
	92.10 ~ 98.12	HN-251			FN-7750	
KV3, KV4	90. 3 ~ 92. 9	HN-251			FN-7743	
	92.10 ~ 98.12	HN-251			FN-7750	

SUBARU - 3

Model 車種形式	Year 年式	Front フロント		Rear リア		Parking パーキング
		Pad パッド	Shoe シュー	Pad パッド	Shoe シュー	Shoe シュー
SAMBAR						
660 TV1,TV2	99.1 ~ 04.8	HN-477				FN-9952
	04.9 ~ 12.3	HN-525				FN-9952
TT1,TT2	99.1 ~ 04.8	HN-477				FN-9952
	04.9 ~ 12.3	HN-525				FN-9952
TW1,TW2 DIAS WAGON	99.1 ~ 02.8	HN-477				FN-9952
	02.9 ~ 09.8	HN-263				FN-9952
STELLA						
660 RN1,RN2	06.6 ~ 11.4	HN-426				FN-7756
DIAS WAGON						
660 S321N,S331N	09.8 ~ 14.5	HN-512				FN-0038
	14.5 ~	HN-492				FN-0041
DEX						
1300 M401F	08.10 ~ 11.10	HN-443				FN-2397
M411F	08.10 ~ 11.10	HN-443				FN-0041
DOMINGO						
1000 KJ5	83.10 ~ 94.6	HN-080				FN-7734
12 inch	83.10 ~ 94.6	HN-080				FN-7724
1200 KJ8	86.6 ~ 94.6	HN-080				FN-7734
12 inch	94.6 ~ 98.11	HN-080				FN-7724
FA7,FA8	94.6 ~ 98.11	HN-251				FN-7750
TRAVIQ						
2200 XM220	01.8 ~ 04.12					
TOREZIA						
1300 NSP120X	10.11 ~	HN-518				FN-2389
1500 NCP120X,NCP125X	10.11 ~	HN-518				FN-2389
FORESTER						
2000 SF5	97.2 ~ 02.1	HN-390				FN-7747
TURBO	97.2 ~ 02.1	HN-390		HN-415		
S/TB ST1	00.5 ~ 02.1	HN-463		HN-415		
SG5 X,X20	01.11 ~ 07.11	HN-460				FN-7747
XT,CROSS SPORTS	01.11 ~ 03.1	HN-460		HN-415		
	03.2 ~ 07.11	HN-460				
SH5	~051867	07.12 ~ 10.5	HN-460		HN-501	
	051868~	10.5 ~ 12.11	HN-579		HN-501	
12500SF9	98.8 ~ 02.1	HN-390		HN-415		
SG9 BREMBO CALIPER	03.11 ~ 07.11					
SH9	10.11 ~ 12.11	HN-579		HN-501		

- NISSAN
- TOYOTA (HINO)
- MAZDA
- ISUZU
- HONDA
- MITSUBISHI
- SUBARU**
- SUZUKI
- DAIHATSU
- LEXUS
- INFINITY
- HYUNDAI
- KIA

SUBARU - 4

- NISSAN
- TOYOTA
(HINO)
- MAZDA
- ISUZU
- HONDA
- MITSUBISHI
- SUBARU**
- SUZUKI
- DAIHATSU
- LEXUS
- INFINITI
- HYUNDAI
- KIA

Model 車種形式	Year 年式	Front フロント		Rear リア		Parking パーキング
		Pad パッド	Shoe シュー	Pad パッド	Shoe シュー	Shoe シュー
PLEO						
660 RA1, RA2	98. 4 ~ 10. 4	HN-433			FN-7731	
RS	98. 4 ~ 10. 4	HN-433		HN-277		
RV1, RV2	98. 6 ~ 10. 4	HN-433			FN-7731	
LUCRA						
660 L455F W/O TURBO	10. 4 ~ 12. 4	HN-428			FN-0027	
RS TURBO	10. 4 ~ 12. 4	HN-492			FN-0027	
L465F	10. 4 ~ 12. 4	HN-492			FN-0043	
LEONE						
1500 CVFY10 W/O ABS	94. 8 ~ 99. 6	HN-226			FN-1185	
W/ ABS	94. 8 ~ 99. 6	HN-225			FN-1198	
CVFNY10 W/O ABS	94. 4 ~ 99. 6	HN-225			FN-1170	
W/ ABS	94. 4 ~ 99. 6	HN-225			FN-1198	
CVFY11 W/O ABS	99. 6 ~ 04. 5	HN-435			FN-1170	
W/ ABS	99. 6 ~ 04. 5	HN-435			FN-1198	
1600 AA2, AP2, AP8	84. 7 ~ 94. 3	HN-153			FN-7729	
AA3, AP3, AP9	84. 7 ~ 94. 3	HN-153			FN-7730	
1700 CVSNY10 W/O ABS	94. 8 ~ 99. 6	HN-225			FN-1170	
W/ ABS	94. 8 ~ 99. 6	HN-225			FN-1198	
1800 CVHNY11 W/O ABS	99. 6 ~ 04. 5	HN-435			FN-1170	
W/ ABS	99. 6 ~ 04. 5	HN-435			FN-1198	
2000 CVENY10 W/O ABS	94. 9 ~ 99. 5	HN-225			FN-1170	
W/ ABS	94. 9 ~ 99. 5	HN-225			FN-1198	
2200 CVENY11 W/O ABS	99. 6 ~ 03. 8	HN-435			FN-1170	
W/ ABS	99. 6 ~ 03. 8	HN-435			FN-1198	
LEGACY						
1800 BC2, BC3	89. 2 ~ 93. 9	HN-248		HN-249	FN-7744	
BD2, BD3	94. 6 ~ 96. 5	HN-248		HN-249	FN-7747	
	96. 6 ~ 98.11	HN-398		HN-249	FN-7747	
BG2 W/O ABS	96. 6 ~ 98.11	HN-398			FN-7747	
W/ ABS	96. 6 ~ 98.11	HN-398		HN-249		
BG3	94. 6 ~ 96. 5	HN-248			FN-7747	
	96. 6 ~ 98.11	HN-398		HN-249		
2000 BC4 VZ, BRI	89. 2 ~ 93. 9	HN-246		HN-249		
VZ, TYPE-R	91. 6 ~ 93. 9	HN-247		HN-249		
BD4 14 inch	93.10 ~ 96. 5	HN-248		HN-249	FN-7747	
BRI, B-GOLD	96. 6 ~ 98.11	HN-398		HN-249		
BD5 14 inch	93.10 ~ 96. 5	HN-248		HN-249	FN-7747	
TS-R	96. 6 ~ 97. 7	HN-398		HN-249		
GT-TURBO	93.10 ~ 96. 5	HN-247		HN-249		
RS, GT-TURBO	96. 6 ~ 97. 7	HN-390		HN-249		

SUBARU - 5

Model 車種形式	Year 年式	Front フロント		Rear リア		Parking パーキング
		Pad パッド	Shoe シュー	Pad パッド	Shoe シュー	Shoe シュー
LEGACY						
2000 BD5	14 inch		HN-398		HN-249	
	15 inch		HN-390		HN-249	
BG4	TX		HN-248		HN-249	FN-7747
	TX-S		HN-398		HN-249	
BG5	TX-S, BRI		HN-248		HN-249	FN-7747
	TX-S, BRI		HN-398		HN-249	
	GT-TURBO		HN-247		HN-249	
	GT-B TURBO		HN-390		HN-249	
	GT, GT-V TURBO		HN-390		HN-249	
	TS-R 16 inch WHEEL		HN-390		HN-249	
	TS-R W/O 16 inch WHEEL		HN-398		HN-249	
BGA			HN-248		HN-249	FN-7747
			HN-398		HN-249	
BH5	TX, TX-S		HN-398			FN-7753
			HN-493			FN-7753
	BRI		HN-398			FN-7753
	TS-R, GT, GT-B 2POT CALIPER		HN-390		HN-415	
	GT-B 4POT CALIPER		HN-463		HN-415	
	BRI-S		HN-390		HN-415	
BE5	RS, RSK-TURBO		HN-390		HN-415	
	S		HN-390		HN-415	
	RSK GTB		HN-463		HN-415	
	RSK GTB LTD I I		HN-460		HN-415	
BES	RSK GTB S-EDITION, SPECIAL SPEC		HN-463		HN-415	
BL5	B4 2.0I		HN-460		HN-501	
	B4 2.0R		HN-460		HN-501	
	B4 2.0GT		HN-499		HN-415	
	B4 2.0GT-SPEC BREMBO CALIPER					
BP5	2.0I-CASUAL EDITION		HN-460		HN-501	
	2.0R		HN-460		HN-501	
	2.0GT W/O OP88-9		HN-499		HN-415	
	2.0GT		HN-460		HN-501	
	2.0GT-LTD W/ OPC75,76,77		HN-460		HN-501	
	2.0GT-LTD W/O OPC,75,76,77		HN-499		HN-501	
	2.0GT-SPEC-B		HN-499		HN-415	
	2.0GT-SPEC-B BREMBO CALIPER					
2200 BG7, BGB			HN-248		HN-249	
2500 BD9, BG9, BGC			HN-247		HN-249	
			HN-390		HN-249	
BH9	250S, 250T, LAN		HN-390		HN-415	
	LAN W/O VDC		HN-460		HN-415	
BHC			HN-390		HN-415	
BE9	RS25		HN-390		HN-415	
BP9			HN-460		HN-501	
BL9, BP9	2.5I		HN-460		HN-501	
	2.5I SI-CRUISE		HN-499		HN-415	
	STI					

- NISSAN
- TOYOTA
(HINO)
- MAZDA
- ISUZU
- HONDA
- MITSUBISHI
- SUBARU**
- SUZUKI
- DAIHATSU
- LEXUS
- INFINITY
- HYUNDAI
- KIA

SUZUKI - 1

Model 車種形式			Year 年式	Front フロント		Rear リア		Parking パーキング
				Pad パッド	Shoe シュー	Pad パッド	Shoe シュー	Shoe シュー
Kei								
660	HN11S, HN21S		98.10 ~ 01. 4	HN-426			FN-9959	
	HN12S		01. 4 ~ 01.11	HN-426			FN-9959	
	HN22S	500001~770000	01. 4 ~ 03. 9	HN-426			FN-9959	
		620001~643167	03. 9 ~ 06. 4	HN-426			FN-9967	
		643168~890505	06. 4 ~ 09. 9	HN-566			FN-9967	
	TURBO	720001~750000	01.11 ~ 02.11	HN-426			FN-9959	
	TURBO	770001~880000	01. 4 ~ 09. 9	HN-426			FN-9967	
	WORKS	750001~880000	02.11 ~ 09. 9	HN-426		HN-266		
MR WAGON								
660	MF21S		01.12 ~ 03. 9	HN-426			FN-9959	
			03. 9 ~ 04.12	HN-426			FN-9967	
			04.12 ~ 06. 1	HN-566			FN-9967	
	MF22S		06. 1 ~ 11. 1	HN-566			FN-9967	
	MF33S		11. 1 ~ 13. 7	HN-566			FN-9967	
			13. 7 ~ 15.12	HN-566			FN-9999	
S X 4								
1500	YA11S		06. 7 ~ 15. 2	HN-504				
	YB11S	4WD	06. 7 ~ 15. 2	HN-504				
	YC11S	SEDAN	07. 7 ~ 14. 3	HN-504				
2000	YA41S		06. 7 ~ 15. 2	HN-504		HN-397		
	YB41S	4WD	06. 7 ~ 15. 2	HN-504		HN-397		
X - 9 0								
1600	LB11S		95.10 ~ 97.12	HN-298			FN-9955	
ALTO								
660	CL21V		90. 3 ~ 91. 9	HN-183			FN-9931	
	CM21V		90. 3 ~ 91. 9	HN-182			FN-9928	
	CN21S	W/O ABS	90. 3 ~ 91. 9	HN-183			FN-9931	
		W/ ABS	90. 3 ~ 91. 9	HN-213			FN-9931	
	RS-X	W/O ABS		HN-213			FN-9931	
	RS-X	W/ ABS		HN-213			FN-0032	
	CP21S		90. 3 ~ 91. 9	HN-182			FN-9928	
	TURBO IE		91. 1 ~ 91. 9	HN-183			FN-9928	
	RS-R	W/O ABS	90. 3 ~ 91. 9	HN-213			FN-9928	
	RS-R			HN-213			FN-0032	
	CL22V		91. 9 ~ 94.11	HN-183			FN-9931	
	CM22V	~No. 250000	91. 9 ~ 94.11	HN-182			FN-9928	
		No. 250001~	91. 9 ~ 94.11	HN-183			FN-9928	
	TURBO		91. 9 ~ 94.11	HN-213		HN-399		
	CR22S		91. 9 ~ 94.11	HN-183			FN-9931	
	TURBO IE NAVI		91. 9 ~ 94.11	HN-213			FN-9931	
	RS-X		91. 9 ~ 94.11	HN-213		HN-399		
	CS22S	3 TYPE	~No. 250000	91. 9 ~ 94.11	HN-182		FN-9928	
		4, 5 TYPE	No. 250001~	91. 9 ~ 94.11	HN-183		FN-9928	
	RS-R		91. 9 ~ 94.11	HN-213		HN-399		
	HA11S, HB11S		94.11 ~ 98. 9	HN-378			FN-9944	

- NISSAN
- TOYOTA
(HINO)
- MAZDA
- ISUZU
- HONDA
- MITSUBISHI
- SUBARU
- SUZUKI
- DAIHATSU
- LEXUS
- INFINITY
- HYUNDAI
- KIA

SUZUKI - 2

- NISSAN
- TOYOTA
(HINO)
- MAZDA
- ISUZU
- HONDA
- MITSUBISHI
- SUBARU
- SUZUKI**
- DAIHATSU
- LEXUS
- INFINITI
- HYUNDAI
- KIA

Model 車種形式	Year 年式	Front フロント		Rear リア		Parking パーキング
		Pad パッド	Shoe シュー	Pad パッド	Shoe シュー	Shoe シュー
ALTO						
660 HA11S, HB11S	WORKS	94.11 ~ 98. 9	HN-213		HN-339	
HC11V, HD11V		94.11 ~ 98. 9	HN-378			FN-9944
HA21S, HB21S	WORKS	94.11 ~ 98. 9	HN-213		HN-339	FN-9944
HA12S, HA12V		98.10 ~ 00.12	HN-426			FN-9959
HA22S		98.10 ~ 02. 4	HN-426			FN-9959
	WORKS	98.10 ~ 02. 4	HN-426		HN-266	
HA23V	~No. 200127	00.12 ~ 05. 1	HN-426			FN-9959
	No. 200128~	00.12 ~ 05. 1	HN-426			FN-9967
	~No. 800763	00.12 ~ 05. 1	HN-426			FN-9959
	No. 800764~	00.12 ~ 05. 1	HN-426			FN-9967
HA23S	~No. 115211	00.12 ~ 04. 9	HN-426			FN-9959
	No. 115212~	00.12 ~ 04. 9	HN-426			FN-9967
	~No. 714997	00.12 ~ 04. 9	HN-426			FN-9959
	No. 714998~	00.12 ~ 04. 9	HN-426			FN-9967
	~No. 871674	00.12 ~ 04. 9	HN-426			FN-9959
	No. 871675~	00.12 ~ 04. 9	HN-426			FN-9967
	~No. 901065	00.12 ~ 04. 9	HN-426			FN-9959
	No. 901066~	00.12 ~ 04. 9	HN-426			FN-9967
HA24S	E, G, G SPEC	~No. 135030	04. 9 ~ 09.12	HN-426		FN-9967
		No. 135031~	04. 9 ~ 09.12	HN-523		FN-9967
	X 2WD	~No. 509892	04. 9 ~ 09.12	HN-426		FN-9967
		No. 509893~	04. 9 ~ 09.12	HN-523		FN-9967
	X 4WD	~No. 135030	04. 9 ~ 09.12	HN-426		FN-9967
		No. 135031~	04. 9 ~ 09.12	HN-523		FN-9967
HA24V		~No. 104000	05. 1 ~ 09.12	HN-426		FN-9967
		No. 104001~	05. 1 ~ 09.12	HN-523		FN-9967
ALTO LAPIN						
660 HE21S	~No. 140000	02. 1 ~ 03. 9	HN-426			FN-9959
	No. 140001~	03. 9 ~ 04. 4	HN-426			FN-9967
	~No. 420000	02. 4 ~ 03. 9	HN-426			FN-9959
	No. 420001~	03. 9 ~ 05.12	HN-426			FN-9967
	~No. 950000	02.10 ~ 05.12	HN-426			FN-9959
	No. 950001~	05.12 ~ 08.11	HN-523			FN-9967
	~No. 519297	04. 4 ~ 05.12	HN-426			FN-9967
	No. 519298~	05.12 ~ 08.11	HN-523			FN-9967
	~No. 161593	04. 4 ~ 05.12	HN-426			FN-9967
	No. 161594~	05.12 ~ 08.11	HN-523			FN-9967
HE22S		08.11 ~ 13. 5	HN-523			FN-9967
		13. 6 ~ 15. 5	HN-566			
ESCUDO						
1600 TA01R	~No. 830000	90. 8 ~ 95. 5	HN-298			FN-9937
	No. 830001~	95. 5 ~ 97.11	HN-298			FN-9955
TA01W	~No. 900000	90. 8 ~ 95. 5	HN-298			FN-9937
	No. 900001~	95. 5 ~ 97.11	HN-298			FN-9955
TD01W	NOMADE	~No. 250000	90. 9 ~ 95. 5	HN-301		FN-9942
		No. 250543~	95. 5 ~ 97.11	HN-301		FN-9947
TA02W, TD02W		97.11 ~ 02.11	HN-301			

SUZUKI - 3

Model 車種形式		Year 年式	Front フロント		Rear リア		Parking パーキング
			Pad パッド	Shoe シュー	Pad パッド	Shoe シュー	Shoe シュー
ESCUDO							
1600	TA74W		06. 6 ~				
2000	TA11W	No. 102053~	94.12 ~ 96.11	HN-382			FN-9947
	TD11W	No. 107047~	94.12 ~ 96.11	HN-382			FN-9947
	TA31W	No. 100602~	94.12 ~ 97.10	HN-382			FN-9947
	TD31W	No. 102136~	94.12 ~ 97.10	HN-382			FN-9947
	TA51W, TD51W		96.10 ~ 97.10	HN-382			FN-9947
	TL52W	~No. 150000	98.11 ~ 00. 4	HN-301			
		No. 150001~	00. 4 ~ 05. 5	HN-382			
	TD32W		98. 2 ~ 99.10	HN-382			
	TA52W, TD52W		97.11 ~ 02.11	HN-301			
	TD54W		05. 5 ~				
2400	TDA4W		08. 6 ~				
2500	TD61W		96.10 ~ 97.10	HN-382			FN-9947
	TD62W		98. 2 ~ 05. 5	HN-382			
2700	TX92W	GRAND ESTATE	00.12 ~ 05. 5	HN-382			FN-9968
	TD94W		05. 5 ~				
3200	TDB4W		08. 6 ~				
EVERY							
660	DA51V	4MT	90. 3 ~ 91. 9	HN-408	FN-9932		FN-9919
		5MT, AT	90. 3 ~ 91. 9	HN-408	FN-9932		FN-9923
	DB51V		90. 3 ~ 91. 9	HN-408	FN-9932		FN-9923
	DE51V, DF51V	~No. 770000	91. 9 ~ 95. 5	HN-408			FN-9943
		No. 770001~	95. 5 ~ 99. 1	HN-408			FN-9952
	DA52V, DB52V		99. 1 ~ 01. 9	HN-439			FN-9962
	DA62V		01. 9 ~ 05. 8	HN-439			FN-9962
	DA52W	WAGON	99. 6 ~ 01. 9	HN-439			FN-9962
	DA62W	WAGON	01. 9 ~ 05. 8	HN-439			FN-9962
	DA64V		05. 8 ~ 15. 2	HN-523			FN-9973
	DA64W	WAGON	05. 8 ~ 15. 2	HN-523			FN-9973
	DA17V		15. 2 ~	HN-566			
1300	DA32W	PLUS, LANDY	99. 6 ~ 05. 7	HN-443			FN-5524
AERIO							
1500	RB21S		01. 1 ~ 06. 1	HN-461			FN-0032
	RA21S	SEDAN	01.11 ~ 07. 3	HN-461			FN-0032
1800	RC51S		03. 1 ~ 07. 3	HN-461			FN-0032
	RD51S		03. 1 ~ 06. 1	HN-461			FN-0032
CAPPUCCINO							
660	EA11R, EA21R		91.10 ~ 98.10	HN-169		HN-339	

- NISSAN
- TOYOTA
(HINO)
- MAZDA
- ISUZU
- HONDA
- MITSUBISHI
- SUBARU
- SUZUKI**
- DAIHATSU
- LEXUS
- INFINITY
- HYUNDAI
- KIA

SUZUKI - 4

- NISSAN
- TOYOTA
(HINO)
- MAZDA
- ISUZU
- HONDA
- MITSUBISHI
- SUBARU
- SUZUKI**
- DAIHATSU
- LEXUS
- INFINITI
- HYUNDAI
- KIA

Model 車種形式	Year 年式	Front フロント		Rear リア		Parking パーキング
		Pad パッド	Shoe シュー	Pad パッド	Shoe シュー	Shoe シュー
CULTUS						
1000 AA44S, AB44S	88. 9 ~ 00. 5	HN-208			FN-9933	
1300 AA34S R, RE	88. 9 ~ 00. 5	HN-208			FN-9933	
GT-I	88. 9 ~ 00. 5	HN-367				
AB34S G, GE	88. 9 ~ 00. 5	HN-208			FN-9933	
XL, XS	88. 9 ~ 00. 5	HN-208			FN-0032	
AF34S RE	89.10 ~ 00. 5	HN-208			FN-0032	
GT-I	89.10 ~ 00. 5	HN-367				
AK34S CONVERTIBLE	92. 1 ~ 00. 5	HN-367			FN-9933	
1500 AH64S, AJ64S	91. 7 ~ 95. 3	HN-169			FN-0032	
1600 AH14S	89. 6 ~ 91. 7	HN-169			FN-0032	
AJ14S	89.10 ~ 95. 3	HN-169			FN-0032	
CULTUS CRESCENT						
1300 GA11S	W/O ABS 95. 1 ~ 99. 5	HN-208			FN-0032	
No140001~	W/ ABS 95. 1 ~ 99. 5	HN-381			FN-0032	
1500 GA21S, GB21S	95. 1 ~ 96. 2	HN-381			FN-0032	
GC21S, GD21S	95. 1 ~ 02. 7	HN-381			FN-0032	
GC21W	96. 2 ~ 02. 7	HN-381			FN-0032	
1600 GB31S, GD31S	96. 2 ~ 02. 7	HN-381			FN-0032	
GD31W	96. 2 ~ 02. 7	HN-381			FN-0032	
1800 GC41W	96. 2 ~ 02. 7	HN-381		HN-198		
KIZASHI						
2400 RE91S, RF91S	09.10 ~ 15. 1	HN-546		HN-397		
CARA						
660 PG6SS	93. 1 ~ 96. 5	HN-183		HN-130		
CARRY						
660 DA51T, DA51B	90. 3 ~ 91. 9	HN-408	FN-9932		FN-9919	
DB51T	90. 3 ~ 91. 9	HN-408	FN-9932		FN-9919	
DC51B, DD51B	91. 9 ~ 97. 4	HN-408	FN-9932		FN-9943	
DC51T, DD51T MT	~No. 390000 91. 9 ~ 99. 1	HN-408	FN-9932		FN-9919	
DC51T MT	No. 390001~ 95. 5 ~ 99. 1	HN-408			FN-9951	
AT	91. 9 ~ 99. 1	HN-408	FN-9932		FN-9943	
DA52T, DB52T ORIGINAL EQUIPMENT CAR	99. 1 ~ 01. 9	HN-439			FN-5524	
THE ABOVE IS EXCLUDED.	99. 1 ~ 01. 9	HN-439			FN-9951	
DA62T ORIGINAL EQUIPMENT CAR	01. 9 ~ 02. 5	HN-439			FN-5524	
THE ABOVE IS EXCLUDED	01. 9 ~ 02. 5	HN-439			FN-9951	
DA63T ~No. 380000	02. 5 ~ 05. 8	HN-426			FN-9966	
ORIGINAL EQUIPMENT CAR	No. 380001~ 05. 8 ~ 05.11	HN-523			FN-5524	
THE ABOVE IS EXCLUDED	No. 380001~ 05. 8 ~ 05.11	HN-523			FN-9966	
No. 410001~	05.11 ~ 08. 4	HN-523			FN-9966	

SUZUKI - 5

Model 車種形式	Year 年式	Front フロント		Rear リア		Parking パーキング
		Pad パッド	Shoe シュー	Pad パッド	Shoe シュー	Shoe シュー
CARRY						
660 DA63T ORIGINAL EQUIPMENT CAR No.560001~	08. 4 ~ 13. 9	HN-523				FN-5524
THE ABOVE IS EXCLUDED No. 560001~	08. 4 ~ 13. 9	HN-523				FN-9966
DA65T	05.11 ~ 13. 9	HN-523				FN-9966
CHEVROLET MW						
1300 ME34S	06. 1 ~ 10. 8	HN-406				FN-9959
CHEVROLET CRUZE						
1300 HR51S	01.11 ~ 03.11	HN-443				FN-9959
HR52S	03.11 ~ 08. 5	HN-443				FN-9959
1500 HR81S	01.11 ~ 03.11	HN-443				FN-9959
HR82S	03.11 ~ 06. 5	HN-443				FN-9959
JIMNY						
660 JA11C, JA11V	90. 3 ~ 95.11	HN-118				FN-9921
JA12C, JA12V	95.11 ~ 98.10	HN-118				FN-9921
JA12W, JA22W	95.11 ~ 98.10	HN-118				FN-9921
JB23W	98.10 ~	HN-118				FN-5524
1300 JB31W, JB32W SIERRA	93. 5 ~ 97.12	HN-118				FN-9921
JB33W WIDE	98. 1 ~ 00. 4	HN-118				FN-5524
JB43W WIDE SIERRA	00. 4 ~	HN-118				FN-5524
SWIFT						
1200 ZC71S	07. 5 ~ 10. 9	HN-529				FN-9969
ZC72S XG, XL	10. 9 ~ 16.12	HN-529				
XS	10. 9 ~ 16.12	HN-562		HN-581		
RS	11.11 ~ 12.11	HN-529				
RS	12.11 ~ 13. 7	※		HN-581		
※FRONT PAD HN-529orHN-526						
RS	13. 7 ~ 16.12	HN-562		HN-581		
ZD72S	10. 9 ~	HN-562		HN-581		
1300 HT51S SX, SC, SE	00. 2 ~ 04.11	HN-443				FN-9959
ZC11S	04.11 ~ 10. 9	HN-529				FN-9969
ZD11S 4WD	04.11 ~ 10. 9	HN-529				FN-0032
1500 HT81S	03. 6 ~ 04.11	HN-443				
ZC21S	04.11 ~ 10. 9	HN-529				FN-9969
ZD21S 4WD	04.11 ~ 10. 9	HN-529				FN-0032
1600 ZC31S SPORTS	05. 9 ~ 10. 9	HN-529		HN-397		
ZC32S	11.12 ~	HN-562		HN-581		
SPLASH						
1200 XB32S	08.10 ~ 14. 8	HN-529				FN-2386

- NISSAN
- TOYOTA (HINO)
- MAZDA
- ISUZU
- HONDA
- MITSUBISHI
- SUBARU
- SUZUKI**
- DAIHATSU
- LEXUS
- INFINITY
- HYUNDAI
- KIA

SUZUKI - 6

- NISSAN
- TOYOTA
(HINO)
- MAZDA
- ISUZU
- HONDA
- MITSUBISHI
- SUBARU
- SUZUKI**
- DAIHATSU
- LEXUS
- INFINITI
- HYUNDAI
- KIA

Model 車種形式	Year 年式	Front フロント		Rear リア		Parking パーキング
		Pad パッド	Shoe シュー	Pad パッド	Shoe シュー	Shoe シュー
CERVO・CERVO MODE						
660 CN21S			HN-183			FN-9931
CN31S	W/O ABS	90.7 ~ 91.9	HN-213			FN-9931
	W/ ABS	90.7 ~ 91.9	HN-213			FN-0032
CP21S		90.11 ~ 91.9	HN-182			FN-9928
CP31S	W/O ABS	90.7 ~ 91.9	HN-213			FN-9928
	W/ ABS	90.7 ~ 91.9	HN-213			FN-0032
CN22S	W/O ABS	~No.25000	HN-183			FN-9931
	W/ ABS	~No.250000	HN-213			FN-9931
	3DORRES	No.250001~	HN-183			FN-9931
	5D0ORS	No.700001~	HN-183			FN-9931
	TURBO		HN-213			FN-9931
	3D0ORS	No.370001~	HN-378			FN-9944
	5D0ORS	No.870001~	HN-378			FN-9944
	TURBO		HN-213			FN-9944
	3D0ORS	No.420001~	HN-378			FN-9944
	5D0ORS	No.920001~	HN-378			FN-9944
CN32S, CP32S	SR-F TURBO		HN-213		HN-339	
CP22S	3D0ORS	No.250001~	HN-183			FN-9928
	5D0ORS	No.800001~	HN-183			FN-9928
	TURBO		HN-213			FN-9928
	3D0ORS	No.370001~	HN-378			FN-9944
	5D0ORS	No.870001~	HN-378			FN-9944
	TURBO		HN-213			FN-9944
	3D0ORS	No.420001~	HN-378			FN-9944
	5D0ORS	No.920001~	HN-378			FN-9944
HG21S		06.11 ~ 09.11	HN-566			FN-9967
TWIN						
660 EC22S	~No.122797	03.1 ~ 03.9	HN-426			FN-9959
	No.122798~	03.9 ~ 05.8	HN-426			FN-9967
PALETTE						
660 MK21S		08.1 ~ 13.3	HN-523			FN-9967
LANDY						
2000 SC26, SNC26		10.12 ~	HN-517		HN-565	
WAGON R						
660 CT21S	RA, RG, RX	~No.360000	93.9 ~ 95.10	HN-183		FN-9931
		No.360001~	95.10 ~ 97.4	HN-378		FN-9944
	RTS, RT	~360000	93.9 ~ 95.10	HN-213		FN-9931
		No.360001~	95.10 ~ 97.4	HN-213		FN-9944
	RG, RC	No.540001~	97.4 ~ 98.10	HN-378		FN-9944
	SC, RG TURBO		97.4 ~ 98.10	HN-213		FN-9944
CV21S	RG4, RG4S	~No.150000	93.9 ~ 95.10	HN-183		FN-9928
		No.150001~	95.10 ~ 97.4	HN-378		FN-9944
	RTS, RT	~No.150000	93.9 ~ 95.10	HN-213		FN-9928
		No.150001~	95.10 ~ 97.4	HN-213		FN-9944
	RGS	W/O ABS	97.4 ~ 98.10	HN-378		FN-9944

SUZUKI - 7

Model 車種形式	Year 年式	Front フロント		Rear リア		Parking パーキング
		Pad パッド	Shoe シュー	Pad パッド	Shoe シュー	Shoe シュー
WAGON R						
660 CV21S RGS, SC TURBO	W/ ABS	97. 4 ~ 98.10	HN-213			FN-9944
CT51S, CV51S FM, RX, SL		97. 4 ~ 98.10	HN-378			FN-9944
	FX, SC	W/O ABS	97. 4 ~ 98.10	HN-378		FN-9944
	FX, SC	W/ ABS	97. 4 ~ 98.10	HN-213		FN-9944
CT51S RS, RR, FR		97. 4 ~ 98.10	HN-213			FN-9944
MC11S FX		98.10 ~ 03. 9	HN-426			FN-9959
MC12S		00.12 ~ 01.11	HN-426			FN-9959
MC21S FM, FG, RR		98.10 ~ 00.12	HN-426			FN-9959
MC22S		00.12 ~ 03. 9	HN-426			FN-9959
MH21S TURBO	~No. 840000	03. 9 ~ 05. 9	HN-426			FN-9967
	TURBO	05. 9 ~ 07. 5	HN-523			FN-9967
	W/OUT TURBO	~No. 300000	03. 9 ~ 04.12	HN-426		FN-9967
	W/OUT TURBO	No. 300001~	04.12 ~ 07. 5	HN-523		FN-9967
MH22S		07. 2 ~ 08. 9	HN-523			FN-9967
MH23S A TURBO IS INCLUDED		08. 9 ~ 12. 9	HN-523			FN-9967
WAGON R SOLIO						
1000 MA64S		00.12 ~ 02.11	HN-406			FN-9959
1300 MA34S		00.12 ~ 11. 2	HN-406			FN-9959
WAGON R PLUS・WIDE						
1000 MA61S, MB61S WIDE		97. 2 ~ 99. 6	HN-406			FN-9944
MA63S PLUS		99. 5 ~ 00.12	HN-406			FN-9959

- NISSAN
- TOYOTA (HINO)
- MAZDA
- ISUZU
- HONDA
- MITSUBISHI
- SUBARU
- SUZUKI**
- DAIHATSU
- LEXUS
- INFINITY
- HYUNDAI
- KIA

DAIHATSU - 1

- NISSAN
- TOYOTA
(HINO)
- MAZDA
- ISUZU
- HONDA
- MITSUBISHI
- SUBARU
- SUZUKI
- DAIHATSU**
- LEXUS
- INFINITI
- HYUNDAI
- KIA

Model 車種形式	Year 年式	Front フロント		Rear リア		Parking パーキング
		Pad パッド	Shoe シュー	Pad パッド	Shoe シュー	Shoe シュー
Y R V						
1000 M200G	00. 8 ~ 02.12	HN-427			FN-0037	
1300 M201G L	00. 8 ~ 05. 7	HN-427			FN-0037	
TURBO	00. 8 ~ 05. 7	HN-443			FN-0037	
M211G L	00. 8 ~ 05. 7	HN-427			FN-0036	
TURBO	00. 8 ~ 05. 7	HN-443			FN-0036	
ATRAI						
660 S220V, S230V	98.12 ~ 00. 5	HN-438			FN-0029	
	00. 5 ~ 01.12	HN-438			FN-0038	
TURBO	98.12 ~ 00. 1	HN-341			FN-0029	
S220G, S230G	99. 5 ~ 00. 5	HN-438			FN-0029	
CUSTOM TURBO	00. 5 ~ 04.12	HN-438			FN-0038	
CUSTOM TURBO	99. 5 ~ 00. 5	HN-341			FN-0029	
CUSTOM TURBO R	00. 5 ~ 04.12	HN-341			FN-0038	
S320G, S330G	05. 4 ~ 07.12	HN-512			FN-0038	
S321G, S331G	07. 8 ~ 14. 5	HN-512			FN-0038	
S321G, S331G	14. 5 ~	HN-492			FN-0041	
ATRAI7						
1300 S221G X	00. 7 ~ 04.11	HN-341			FN-0041	
X SPORTY W/ ABS	02. 6 ~ 04.11				FN-0041	
S231G X	00. 7 ~ 04.11	HN-341			FN-0041	
X SPORTY W/ ABS	02. 6 ~ 04.11				FN-0041	
APPLAUSE・CHARMANT						
1300 A35	81.10 ~ 87. 7	HN-067			FN-2203	
1500 A55	81.10 ~ 87. 7	HN-067			FN-2203	
1600 A101S, A111S	89. 6 ~ 00. 5	HN-214		HN-198	FN-0032	
ALTIS						
2200 SXV20N	00. 3 ~ 01. 9	HN-322		HN-431		
SXV25N 4WD	00. 3 ~ 01. 9	HN-401		HN-321		
2400 ACV30N	01. 9 ~ 06. 1	HN-479		HN-458		
ACV35N	01. 9 ~ 06. 1	HN-479		HN-321		
ACV40N	06. 1 ~ 10. 3	HN-521		HN-522		
ACV45N	06. 1 ~ 10. 3	HN-521		HN-458		
2500 AVV50N	12. 5 ~	HN-521		HN-522		
ESSE						
660 L235S	05.12 ~ 11. 9	HN-428			FN-0027	
L245S 4WD	05.12 ~ 11. 9	HN-428			FN-0030	
OPTi						
660 L300S SUMITOMO BRAKE CALIPER	92. 2 ~ 98. 8	HN-114			FN-0027	

DAIHATSU - 2

Model 車種形式		Year 年式	Front フロント		Rear リア		Parking パーキング
			Pad パッド	Shoe シュー	Pad パッド	Shoe シュー	Shoe シュー
OPTi							
	AKEBONO BRAKE CALIPER		92. 2 ~ 98. 8	HN-451			FN-0027
660	L310S		92. 2 ~ 98. 8	HN-114			FN-0025
	L800S	W/O ABS	98.11 ~ 02. 8	HN-428			FN-0027
		W/ ABS	98.11 ~ 99. 8	HN-428			FN-0036
		W/ ABS	99. 9 ~ 02. 8	HN-428			FN-0037
	TURBO	W/O ABS	98.11 ~ 02. 8	HN-427			FN-0027
		W/ ABS	98.11 ~ 99. 8	HN-427			FN-0036
		W/ ABS	99. 9 ~ 02. 8	HN-427			FN-0037
	L802S	AERODOWNBEEEX	W/O ABS	98.11 ~ 00. 2	HN-427		FN-0027
			W/ ABS	98.11 ~ 99. 8	HN-427		FN-0036
			W/ ABS	99. 9 ~ 00. 2	HN-427		FN-0037
	L810S	CL, CX, BEEEX	W/O ABS	98.11 ~ 02. 8	HN-428		FN-0020
			W/ ABS	98.11 ~ 02. 8	HN-428		FN-0036
		AERODOWNBEEEX	W/O ABS	98.11 ~ 02. 8	HN-427		FN-0037
			W/ ABS	98.11 ~ 02. 8	HN-427		FN-0036
COO							
1300	M401S		06. 5 ~ 13. 1	HN-443			FN-2397
	M411S	4WD	06. 5 ~ 13. 1	HN-443			FN-0041
1500	M402S		06. 5 ~ 13. 1	HN-443			FN-2397
COPEN							
660	L880K		02. 6 ~ 12. 8	HN-443			FN-0037
	LA400 TURBO		14. 6 ~	HN-443			FN-2397
CHARADE							
1000	G11, G26, G30		83. 1 ~ 87. 1				FN-0020
	G100S	TX, TD	87. 1 ~ 93. 1	HN-187			FN-0030
		GT TURBO	87. 1 ~ 93. 1	HN-214			
		TR, K1SA TURBO	87. 1 ~ 93. 1	HN-186			FN-0030
	G101S		87. 1 ~ 91.11	HN-187			FN-0030
			91.12 ~ 93. 1	HN-186			FN-0030
1300	G102S	SG, SX	88. 1 ~ 93. 1	HN-186			FN-0030
		TR, CR	88. 1 ~ 90.11	HN-214			FN-0030
	G112S		88. 1 ~ 93. 1	HN-186			FN-0032
	G200S	W/O ABS	93. 1 ~ 96. 8	HN-400			FN-0034
		W/ ABS	93. 1 ~ 96. 8	HN-400	HN-353		
		W/O ABS	96. 8 ~ 00. 3	HN-340			FN-0034
		W/ ABS	96. 8 ~ 00. 3	HN-340	HN-353		FN-0035
1500	G203S	W/O ABS	93. 7 ~ 96. 8	HN-400			FN-0034
		W/ ABS	93. 7 ~ 96. 8	HN-400	HN-353		
		W/O ABS	96. 8 ~ 00. 3	HN-340			FN-0034
		W/ ABS	96. 8 ~ 00. 3	HN-340	HN-353		FN-0035
	G213S	W/O ABS	96. 8 ~ 00. 3	HN-340			FN-0032
		W/ ABS	96. 8 ~ 00. 3	HN-340	HN-353		
			93. 7 ~ 96. 8	HN-400			FN-0032

- NISSAN
- TOYOTA
(HINO)
- MAZDA
- ISUZU
- HONDA
- MITSUBISHI
- SUBARU
- SUZUKI
- DAIHATSU
- LEXUS
- INFINITY
- HYUNDAI
- KIA

DAIHATSU - 3

- NISSAN
- TOYOTA
(HINO)
- MAZDA
- ISUZU
- HONDA
- MITSUBISHI
- SUBARU
- SUZUKI
- DAIHATSU**
- LEXUS
- INFINITI
- HYUNDAI
- KIA

Model 車種形式	Year 年式	Front フロント		Rear リア		Parking パーキング
		Pad パッド	Shoe シュー	Pad パッド	Shoe シュー	Shoe シュー
CHARADE						
1600 G201S	93. 7 ~ 96. 8	HN-400		HN-353	FN-0034	
	96. 8 ~ 98. 7	HN-340		HN-353	FN-0034	
STORIA						
700 M112S	98. 3 ~ 04. 5	HN-427			FN-0020	
1000 M100S	98. 1 ~ 99. 9	HN-427			FN-0036	
	99. 9 ~ 04. 5	HN-427			FN-0037	
M110S	CL W/O ABS	98. 1 ~ 04. 5	HN-427		FN-0020	
	W/ ABS	98. 1 ~ 04. 5	HN-427		FN-0036	
	CX	98. 1 ~ 04. 5	HN-427		FN-0036	
1300 M101S	CX, CZ	00. 5 ~ 04. 5	HN-427		FN-0037	
	TOURING	01.12 ~ 04. 5	HN-443		FN-0037	
M111S	CX, CZ	00. 5 ~ 04. 5	HN-427		FN-0036	
	TOURING	01.12 ~ 04. 5	HN-443		FN-0036	
SONICA						
660 L405S	R	06. 6 ~ 09. 4	HN-428		FN-0042	
	RS	06. 6 ~ 09. 4	HN-492		FN-0042	
L415S	R	06. 6 ~ 09. 4	HN-428		FN-0030	
	RS	06. 6 ~ 09. 4	HN-492		FN-0030	
TANTO						
660 L350S	L, X, X-LTD	W/O ABS	03.11 ~ 07.12	HN-428		FN-0027
		W/ ABS	03.11 ~ 07.12	HN-428		FN-0042
	R, RS, TURBO		03.11 ~ 07.12	HN-492		FN-0042
L360S			03.11 ~ 07.12	HN-492		FN-0030
L375S	X-LTD	W/O ABS	07.12 ~ 10.10	HN-428		FN-0043
		W/ ABS	07.12 ~ 10.10	HN-428		FN-0042
	CUSTOM RS		07.12 ~ 12. 5	HN-492		FN-0042
L385S			07.12 ~ 13.10	HN-492		FN-0043
TANTO Exe						
660 L455S	INCL CUSTOM		09.12 ~ 12. 5	HN-428		FN-0027
	TURBO		09.12 ~ 12. 5	HN-492		FN-0027
L465S	INCL CUSTOM		09.12 ~ 14.10	HN-492		FN-0043
TERIOS						
1300 J100G			97. 3 ~ 99.12	HN-416		FN-2333
		W/ ABS	99.12 ~ 00. 4	HN-416		FN-2333
			99.12 ~ 00. 5	HN-416		FN-2339
J102G			00. 5 ~ 05.12	HN-416		FN-2339
J122G			00. 5 ~ 05.12	HN-416		FN-2339
TERIOS KID						
660 J111G		W/ ABS	98.10 ~ 00. 4	HN-416		FN-2333
	AERODOWN, CUSTOM L		00. 4 ~ 12. 5	HN-416		FN-2339
J131G		W/ ABS	00. 1 ~ 00. 4	HN-416		FN-2333

DAIHATSU - 4

Model 車種形式			Year 年式	Front フロント		Rear リア		Parking パーキング
				Pad パッド	Shoe シュー	Pad パッド	Shoe シュー	Shoe シュー
TERIOS KID								
660	J131G	AERODOWN, CUSTOM X	00. 1 ~ 12. 5	HN-416			FN-2339	
DELTA								
1500	KB27V		90. 8 ~ 91.12	HN-216			FN-2232	
	KR41J		96.10 ~ 98.12	HN-404			FN-2339	
1800	YB20G		88. 8 ~ 91.12	HN-216			FN-2232	
	YB25V		88. 8 ~ 91.12	HN-216			FN-2232	
			92. 1 ~ 96. 9	HN-328			FN-2232	
	KR42J		96.10 ~ 01. 8	HN-404			FN-2339	
2000	CB21G, YB21G		88. 8 ~ 91.12	HN-216			FN-2232	
			92. 1 ~ 96. 9	HN-328			FN-2232	
		W/ ABS	92. 1 ~ 96. 9	HN-328			FN-2252	
	CB27V		88. 8 ~ 91.12	HN-216			FN-2232	
			92. 1 ~ 96. 9	HN-328			FN-2232	
	CR41J		96.10 ~ 98.12	HN-404			FN-2339	
	CR51J		96.10 ~ 98.12	HN-405			FN-2335A	
2200	CB22G	W/O ABS	93. 9 ~ 96. 9	HN-328			FN-2232	
	MT	W/ ABS	93. 9 ~ 96. 9	HN-328			FN-2252	
	CB31G		94.10 ~ 96. 9	HN-327			FN-2252	
	CR42J		99. 1 ~ 02. 8	HN-404			FN-2339	
	CR52J		99. 1 ~ 02. 8	HN-405			FN-2335A	
2500	V20, 30	1.5t	77. 8 ~ 84. 5		FN-2239		FN-2239	
		1.5t	LOW FLOOR	77. 8 ~ 84. 5	FN-2239		FN-4428	
		2t		77. 8 ~ 84. 5	FN-0016		FN-0016	
		2t	LOW FLOOR	77. 8 ~ 84. 5	FN-0016		FN-4428	
		3t		77. 8 ~ 84. 5	FN-0016		FN-0016	
2700	RZU300	2t	00. 5 ~ 03. 6	HN-441			FN-2296	
		3t	00. 5 ~ 03. 6	HN-329			FN-2329	
	RZU340		00. 5 ~ 03. 6	HN-441			FN-2296	
2800	V50	1.5t	77. 8 ~ 84. 5		FN-2239		FN-2239	
		1.5t	LOW FLOOR	77. 8 ~ 84. 5	FN-2239		FN-4428	
		2t		77. 8 ~ 84. 5	FN-0016		FN-0016	
		2t	LOW FLOOR	77. 8 ~ 84. 5	FN-0016		FN-4428	
		3t		77. 8 ~ 84. 5	FN-0016		FN-0016	
	V57	SINGLE TYRE	84. 9 ~ 95. 4		FN-2239		FN-2239	FN-0015
		DOUBLE TYRES	84. 9 ~ 95. 4		FN-2239		FN-4428	FN-0015
3000	V10	1.5t	77. 8 ~ 84. 5		FN-2239		FN-2239	
		1.5t	LOW FLOOR	77. 8 ~ 84. 5	FN-2239		FN-4428	
		2t		77. 8 ~ 84. 5	FN-0016		FN-0016	
		2t	LOW FLOOR	77. 8 ~ 84. 5	FN-0016		FN-4428	
		3t		77. 8 ~ 84. 5	FN-0016		FN-0016	
	V98, V99		84. 9 ~ 95. 4		FN-0016		FN-0016	FN-0015

- NISSAN
- TOYOTA
(HINO)
- MAZDA
- ISUZU
- HONDA
- MITSUBISHI
- SUBARU
- SUZUKI
- DAIHATSU**
- LEXUS
- INFINITY
- HYUNDAI
- KIA

DAIHATSU - 5

- NISSAN
- TOYOTA
(HINO)
- MAZDA
- ISUZU
- HONDA
- MITSUBISHI
- SUBARU
- SUZUKI
- DAIHATSU**
- LEXUS
- INFINITI
- HYUNDAI
- KIA

Model 車種形式			Year 年式	Front フロント		Rear リア		Parking パーキング
				Pad パッド	Shoe シュー	Pad パッド	Shoe シュー	Shoe シュー
DELTA								
3000	V98, V99	LOW FLOOR	84. 9 ~ 95. 4		FN-0016		FN-4428	FN-0015
3400	BU100	FULL JUST LOW	95. 5 ~ 99. 5	HN-229	FN-2297		FN-2297	FN-2298
	DOUBLE TYRES	HIGH FLOOR	95. 5 ~ 99. 5	HN-388	FN-2329		FN-2329	FN-2298
	SINGLE TYRE	HIGH FLOOR	95. 5 ~ 99. 5		FN-2296		FN-2296	FN-2298
BU105		JUST LOW	95. 5 ~ 99. 5		FN-2296		FN-2297	FN-2298
		JUST LOW	95. 5 ~ 99. 5	HN-329	FN-2329		FN-2297	FN-2298
		FULL JUST LOW	95. 5 ~ 99. 5	HN-329	FN-2329		FN-2329	FN-2298
V75,76		HIGH FLOOR	95. 5 ~ 99. 5	HN-330	FN-2329		FN-2329	FN-2298
		LOW FLOOR	84. 9 ~ 88. 9		FN-0016		FN-0016	FN-0039
V78,79		LOW FLOOR	84. 9 ~ 88. 9		FN-0016		FN-4428	FN-0039
		LOW FLOOR	84. 9 ~ 88. 9		FN-0016		FN-0016	FN-0015
3700	V115		88. 8 ~ 95. 4		FN-0016		FN-0016	FN-0015
	V118, V119		88. 8 ~ 95. 4		FN-0016		FN-0016	FN-0015
V116		LOW FLOOR	88. 8 ~ 95. 4		FN-0016		FN-4428	FN-0015
			88. 8 ~ 95. 4		FN-0016		FN-0016	FN-0015
			88. 8 ~ 95. 4		FN-0016		FN-0016	FN-0015
BU301			99. 5 ~ 03. 6	HN-329			FN-2329	FN-0019
		FULL JUST LOW	99. 5 ~ 03. 6	HN-441			FN-2296	FN-0019
BU306		HIGH FLOOR	99. 5 ~ 03. 6	HN-329			FN-2329	FN-0019
		JUST LOW	99. 5 ~ 03. 6	HN-329			FN-2296	FN-0019
BU346		FULL JUST LOW	99. 5 ~ 03. 6	HN-441			FN-2296	FN-0019
		HIGH FLOOR	99. 5 ~ 03. 6	HN-329			FN-2329	FN-0019
		JUST LOW	99. 5 ~ 03. 6	HN-329			FN-2296	FN-0019
4100	BU102	2t FULL JUST LOW	95. 5 ~ 99. 5	HN-229			FN-2297	
	DUMP TRUCK 2t,3t	HIGH FLOOR	95. 5 ~ 99. 5	HN-388			FN-2329	
BU107	DUMP TRUCK DOUBLE TYRES	HIGH FLOOR	95. 5 ~ 99. 5		FN-2329		FN-2329	
		FULL JUST LOW	95. 5 ~ 99. 5		FN-2297		FN-2297	
		JUST LOW	95. 5 ~ 99. 5		FN-2296		FN-2297	
BU112		JUST LOW	96.10 ~ 99. 5	HN-329	FN-2329		FN-2297	
		FULL JUST LOW	96.10 ~ 99. 5	HN-329	FN-2329		FN-2329	
		HIGH FLOOR	96.10 ~ 99. 5	HN-330	FN-2329		FN-2329	
BU142		95. 5 ~ 99. 5	HN-388	FN-2329		FN-2329		
		FULL JUST LOW	95. 5 ~ 99. 5	HN-229			FN-2297	
BU147		HIGH FLOOR	95. 5 ~ 99. 5	HN-388			FN-2329	
		DUMP TRUCK DOUBLE TYRES	HIGH FLOOR	95. 5 ~ 99. 5		FN-2329	FN-2329	
		FULL JUST LOW	95. 5 ~ 99. 5		FN-2297		FN-2297	
BU162		JUST LOW	95. 5 ~ 99. 5		FN-2296		FN-2297	
		JUST LOW	96.10 ~ 99. 5	HN-329			FN-2297	
		FULL JUST LOW	96.10 ~ 99. 5	HN-329			FN-2297	
BU162	DUMP TRUCK	JUST LOW	95. 5 ~ 99. 5		FN-2329		FN-2297	
	DUMP TRUCK	FULL JUST LOW	95. 5 ~ 99. 5		FN-2329		FN-2297	
	DUMP TRUCK	HIGH FLOOR	95. 5 ~ 99. 5		FN-2329		FN-2329	
BU162		JUST LOW	95. 5 ~ 99. 5		FN-2296		FN-2297	
		FULL JUST LOW	95. 5 ~ 99. 5		FN-2296		FN-2297	

DAIHATSU - 6

Model 車種形式	Year 年式	Front フロント		Rear リア		Parking パーキング
		Pad パッド	Shoe シュー	Pad パッド	Shoe シュー	Shoe シュー
DELTA						
4100 BU162	HIGH FLOOR	95.5 ~ 99.5		FN-2296		FN-2329
BU172	FULL JUST LOW	95.5 ~ 99.5		FN-2296		FN-2297
	HIGH FLOOR	95.5 ~ 99.5		FN-2329		FN-2329
BU212	JUST LOW	95.5 ~ 99.5	HN-388	FN-2296		FN-2297
	FULL JUST LOW	95.5 ~ 99.5	HN-388	FN-2329		FN-2297
	HIGH FLOOR	95.5 ~ 99.5	HN-388	FN-2329		FN-2329
BU222		96.10 ~ 99.5	HN-388	FN-2329		FN-2329
BU400, 410	2t	99.8 ~ 03.6	HN-329			FN-2329
	3t, 4t	99.8 ~ 03.6	HN-329			
BU420, 430	2t	99.8 ~ 03.6	HN-329			FN-2329
	3t, 4t	99.8 ~ 03.6	HN-329			
4600 XZU302, 306	FULL JUST LOW	99.5 ~ 03.6	HN-441			FN-2296
	DOUBLE TYRES HIGH FLOOR	99.5 ~ 03.6	HN-329			FN-2329
XZU307	FULL JUST LOW	99.5 ~ 03.6	HN-441			FN-2296
	HIGH FLOOR JUST LOW	99.5 ~ 03.6	HN-329			FN-2329
XZU312	2t	99.5 ~ 03.6	HN-441			FN-2296
	3t	99.5 ~ 03.6	HN-329			FN-2329
XZU322		99.5 ~ 03.6	HN-329			FN-2329
XZU337	JUST LOW	99.5 ~ 03.6	HN-329			FN-2296
	FULL JUST LOW	99.5 ~ 03.6	HN-441			FN-2296
XZU342, 347	FULL JUST LOW	99.5 ~ 03.6	HN-441			FN-2296
	HIGH FLOOR JUST LOW	99.5 ~ 03.6	HN-329			FN-2329
XZU352	FULL JUST LOW	99.5 ~ 03.6	HN-441			FN-2296
	HIGH FLOOR JUST LOW	99.5 ~ 03.6	HN-329			FN-2296
XZU362, 372		99.7 ~ 03.6	HN-330			FN-2329
XZU382		99.7 ~ 03.6	HN-330			FN-2329
XZU402, 412	JUST LOW	99.5 ~ 03.6	HN-329			FN-2296
	FULL JUST LOW	99.5 ~ 03.6	HN-329			FN-2329
4900 XZU301, 331		99.5 ~ 03.6	HN-329			FN-2329
XZU311	2t	99.5 ~ 03.6	HN-441			FN-2296
	3t	99.5 ~ 03.6	HN-329			FN-2329
XZU321, 341		99.5 ~ 03.6	HN-329			FN-2329
XZU346	FULL JUST LOW	99.5 ~ 03.6	HN-441			FN-2296
	HIGH FLOOR JUST LOW	99.5 ~ 03.6	HN-329			FN-2329
XZU351		99.5 ~ 03.6	HN-329			FN-2296
XZU371		99.8 ~ 03.6	HN-330			FN-2329
XZU401		99.5 ~ 03.6				
XZU411, 421	2t	99.5 ~ 03.6	HN-329			FN-2296
	2t	FULL JUST LOW	99.5 ~ 03.6	HN-329		FN-2329
	2t	HIGH FLOOR	99.5 ~ 03.6	HN-329		FN-2329
	3t, 4t	99.5 ~ 03.6	HN-329			
5300 XZU300, 320		99.6 ~ 03.6	HN-329			FN-2329
XZU330	3t	99.5 ~ 03.6	HN-329			FN-2329
	4t	99.5 ~ 03.6				
XZU340	3t	99.6 ~ 03.6	HN-329			FN-2329
	3.5t, 4t	99.6 ~ 03.6				

- NISSAN
- TOYOTA
(HINO)
- MAZDA
- ISUZU
- HONDA
- DAIHATSU
- MITSUBISHI
- SUBARU
- SUZUKI
- LEXUS
- INFINITY
- HYUNDAI
- KIA

DAIHATSU - 7

- NISSAN
- TOYOTA
(HINO)
- MAZDA
- ISUZU
- HONDA
- MITSUBISHI
- SUBARU
- SUZUKI
- DAIHATSU**
- LEXUS
- INFINITI
- HYUNDAI
- KIA

Model 車種形式	Year 年式	Front フロント		Rear リア		Parking パーキング
		Pad パッド	Shoe シュー	Pad パッド	Shoe シュー	Shoe シュー
DELTA						
5300 XZU350	99. 6 ~ 03. 6					
XZU400, 410 2t	99. 5 ~ 03. 6				FN-2329	
3t, 4t	99. 5 ~ 03. 6					
XZU420, 430	99. 5 ~ 03. 6					
DELTA WAGON						
2000 SR40N	96.10 ~ 01.10	HN-404			FN-2339	
SR50N	98. 1 ~ 98.12	HN-405			FN-2335A	
	99. 1 ~ 01.10	HN-404			FN-2335A	
2200 CR40N	96.10 ~ 01.10	HN-404			FN-2339	
CR50N	96.10 ~ 98.12	HN-405			FN-2335A	
	99. 1 ~ 01.10	HN-404			FN-2335A	
NAKED						
660 L750S	W/O ABS 99.11 ~ 03.12	HN-428			FN-0040	
	W/ ABS 99.11 ~ 03.12	HN-428			FN-0037	
TURBO	W/O ABS 99.11 ~ 03.12	HN-427			FN-0040	
TURBO	W/ ABS 99.11 ~ 03.12	HN-427			FN-0037	
L760S	W/O ABS 99.11 ~ 03.12	HN-428			FN-0020	
	W/ ABS 99.11 ~ 03.12	HN-428			FN-0036	
TURBO	W/O ABS 99.11 ~ 03.12	HN-427			FN-0020	
TURBO	W/ ABS 99.11 ~ 03.12	HN-427			FN-0036	
PYZAR						
1500 G303G	W/O ABS 96. 8 ~ 02. 7	HN-340			FN-0035	
	W/ ABS 96. 8 ~ 02. 7	HN-340		HN-353		
G313G	96. 8 ~ 97. 8	HN-340			FN-0032	
1600 G301G	97. 9 ~ 02. 7	HN-340			FN-0035	
G311G	97. 9 ~ 02. 7	HN-340			FN-0032	
HIJET						
550 S80C, S80P, S81P	86. 5 ~ 90. 4	HN-114	FN-0026		FN-0028	
S80V, S81V, S81C	86. 5 ~ 90. 4	HN-114	FN-0026		FN-0029	
660 S82C, S83C	90. 4 ~ 94. 1	HN-114	FN-0026		FN-0028	
S82V, S83V	90. 4 ~ 94. 1	HN-114	FN-0026		FN-0029	
S82P, S83P	90. 4 ~ 94. 1	HN-114	FN-0026		FN-0028	
S82W, S83W	91. 8 ~ 94. 1	HN-114			FN-0029	
S100P, S110P	94. 1 ~ 98.12	HN-355			FN-0029	
S100C, S110C	94. 1 ~ 98.12	HN-355			FN-0029	
S100V, S110V	94. 1 ~ 98.12	HN-341			FN-0029	
S120V, S130V	94. 1 ~ 98.12	HN-341			FN-0029	
S100W, S110W	94. 4 ~ 98.12	HN-341			FN-0029	
S140V	97. 9 ~ 98.12	HN-341			FN-0035	
S200P, S210P	98.12 ~ 00. 4	HN-512			FN-0029	
	00. 4 ~ 07.12	HN-512			FN-0038	
S200C, S210C	98.12 ~ 00. 4	HN-512			FN-0029	

DAIHATSU - 8

Model 車種形式	Year 年式	Front フロント		Rear リア		Parking パーキング
		Pad パッド	Shoe シュー	Pad パッド	Shoe シュー	Shoe シュー
HIJET						
660 S200C, S210C	00. 4 ~ 07.12	HN-512				FN-0038
S200V EFSE	98.12 ~ 00. 4	HN-438				FN-0029
EFVE	00. 5 ~ 04.11	HN-438				FN-0038
S200V MD35	99. 2 ~ 04.11	HN-341				FN-0035
S210V	98.12 ~ 00. 4	HN-438				FN-0029
	00. 5 ~ 04.11	HN-438				FN-0038
S200W, S210W	00. 1 ~ 00. 5	HN-438				FN-0029
	00. 5 ~ 04.11	HN-438				FN-0038
S320V, S330V	04.11 ~ 09. 2	HN-512				FN-0038
S320W, S330W	05. 1 ~ 07.12	HN-512				FN-0038
S201C, S201P	07.12 ~ 14. 8	HN-512				FN-0038
S211C, S211P	07.12 ~ 14. 8	HN-512				FN-0038
S321V, S331V	07.12 ~ 14. 5	HN-512				FN-0038
S321W, S331W	07.12 ~ 14. 5	HN-512				FN-0038
1300 S221V GRANCARGO	01. 7 ~ 04.11	HN-341				FN-0041
S231V GRANCARGO 4WD	01. 7 ~ 04.11	HN-341				FN-0041
BEGO						
1500 J200G	06. 1 ~ 16. 3	HN-416				FN-2339
J210G	06. 1 ~ 16. 3	HN-416				FN-2339
BOON						
1000 M300S	04. 6 ~ 10. 2	HN-492				FN-0042
14inch STEEL WHEELS	06.12 ~ 10. 2	HN-562				FN-2397
M310S	04. 6 ~ 10. 2	HN-492				FN-0030
M312S X4 14inch DISC	06. 3 ~ 10. 2	HN-443				FN-0030
X4	06.12 ~ 10. 2	HN-492				FN-0030
M600S	10. 2 ~ 16. 4	HN-492				FN-0042
M610S CL 4WD	10. 2 ~ 16. 4	HN-492				FN-0043
CL Limited 4WD	10. 2 ~ 16. 4	HN-562				FN-0043
1300 M301S	04. 6 ~ 10. 2	HN-492				FN-0042
14inch STEEL WHEELS	06.12 ~ 10. 2	HN-562				FN-2397
M601S	10. 2 ~ 16. 4	HN-492				FN-0042
BOON LUMINAS						
1500 M502G W/ VSC	08.12 ~ 12. 2	HN-518				FN-2389
W/O VSC	08.12 ~ 12. 2	HN-508				FN-2389
M512G	08.12 ~ 12. 2	HN-518				FN-2389
MAX						
660 L950S L, Li, Xi W/O ABS	01.11 ~ 05.11	HN-428				FN-0040
W/ ABS	01.11 ~ 05.11	HN-428				FN-0037
R, TURBO W/O ABS	01.11 ~ 03. 8	HN-427				FN-0040
W/ ABS, W/ DVS	01.11 ~ 03. 8	HN-427				FN-0037
L952S RS	01.11 ~ 05.11	HN-427				FN-0037
L960S L, Li, Xi W/O ABS	01.11 ~ 05.11	HN-428				FN-0020
W/ ABS	01.11 ~ 05.11	HN-428				FN-0036

- NISSAN
- TOYOTA (HINO)
- MAZDA
- ISUZU
- HONDA
- DAIHATSU
- MITSUBISHI
- SUBARU
- SUZUKI
- LEXUS
- INFINITY
- HYUNDAI
- KIA

DAIHATSU - 9

- NISSAN
- TOYOTA
(HINO)
- MAZDA
- ISUZU
- HONDA
- MITSUBISHI
- SUBARU
- SUZUKI
- DAIHATSU**
- LEXUS
- INFINITI
- HYUNDAI
- KIA

Model 車種形式	Year 年式	Front フロント		Rear リア		Parking パーキング
		Pad パッド	Shoe シュー	Pad パッド	Shoe シュー	Shoe シュー
MAX						
660 L960S R, TURBO	W/O ABS	01.11 ~ 03. 8	HN-427			FN-0020
	W/ ABS	01.11 ~ 03. 8	HN-427			FN-0036
L962S RS		01.11 ~ 05.11	HN-427			FN-0036
MIDGET II						
660 K100C, 100P		96. 3 ~ 01. 7		FN-0026		FN-0029
MIRA						
660 L200S TRXXL, AVANZATO R	~No. 500000	90. 3 ~ 95. 1	HN-295			FN-0027
	No. 500001~	90. 3 ~ 95. 1	HN-295			FN-0024
	AKEBONO BRAKE CALIPER	90. 3 ~ 95. 1	HN-451			FN-0024
	SUMITOMO BRAKE CALIPER	~No. 500000	HN-114			FN-0027
	SUMITOMO BRAKE CALIPER	No. 500001~	HN-114			FN-0024
L210S, L210V RV4		90. 8 ~ 95. 1	HN-295			FN-0025
	AKEBONO BRAKE CALIPER	90. 3 ~ 95. 1	HN-451			FN-0025
	SUMITOMO BRAKE CALIPER	90. 3 ~ 95. 1	HN-114			FN-0025
L200V FRONT DRUM		90. 3 ~ 95. 1		FN-0026		FN-0024
	AKEBONO BRAKE CALIPER	90. 3 ~ 95. 1	HN-451			FN-0027
	SUMITOMO BRAKE CALIPER	90. 3 ~ 95. 1	HN-114			FN-0024
L220S AKEBONO BRAKE CALIPER		90. 4 ~ 93. 7	HN-451			FN-0024
	SUMITOMO BRAKE CALIPER	90. 4 ~ 93. 7	HN-114			FN-0024
L500S, L500V TS, TG SUMITOMO BRAKE CALIPER		94. 8 ~ 98. 8	HN-114			FN-0024
	TS COLD AREA SPEC	94. 8 ~ 95. 1	HN-451			FN-0027
	GS, TS, TL-LTD AKEBONO BRAKE CALIPER	94. 8 ~ 98. 8	HN-451			FN-0027
	TRXX	94. 8 ~ 98. 8	HN-295			FN-0027
L502S TV COLD AREA SPEC		94. 8 ~ 95. 1	HN-451			FN-0027
	13inch DISC	W/ ABS	HN-295		HN-353	
	CV, CX SUMITOMO BRAKE CALIPER	94. 8 ~ 98. 8	HN-114		HN-353	
	CV, CX AKEBONO BRAKE CALIPER	W/ ABS	HN-451			FN-0027
	TRXX AVR 13inch DISC	W/ ABS	HN-295		HN-353	
L510S, L510V	W/O ABS	94. 8 ~ 98. 8	HN-451			FN-0025
	W/ ABS	94. 8 ~ 98. 8	HN-451			FN-0029
L512S TRXX		94. 8 ~ 98. 8	HN-295			FN-0025
L700S TL, TX	W/O ABS	98.10 ~ 04.10	HN-429			FN-0027
	W/ ABS	98.10 ~ 04.10	HN-429			FN-0037
	CL, CX	W/O ABS	HN-429			FN-0027
	W/ ABS	98.10 ~ 04.10	HN-429			FN-0037
	TR, CR TURBO	W/O ABS	HN-427			FN-0027
	W/ ABS	98.10 ~ 04.10	HN-427			FN-0037
	GINO, TV	W/O ABS	HN-428			FN-0037
	W/ ABS	99. 3 ~ 04.10	HN-428			FN-0037
L710S TL, TV, TX	W/O ABS	98.10 ~ 04.10	HN-429			FN-0020
	W/ ABS	98.10 ~ 04.10	HN-429			FN-0036
	CL, CX	W/O ABS	HN-429			FN-0020
	W/ ABS	98.10 ~ 04.10	HN-429			FN-0036
	TR, CR TURBO	W/O ABS	HN-427			FN-0020
	W/ ABS	98.10 ~ 04.10	HN-427			FN-0036
	GINO	W/O ABS	HN-428			FN-0036

DAIHATSU - 10

Model 車種形式			Year 年式	Front フロント		Rear リア		Parking パーキング
				Pad パッド	Shoe シュー	Pad パッド	Shoe シュー	Shoe シュー
MIRA								
660	L710S	W/ ABS	99. 2 ~ 04.10	HN-428			FN-0036	
	L700V	TA, TB	W/O ABS	98.10 ~ 02.12	HN-429		FN-0027	
			W/ ABS	00. 3 ~ 02.12	HN-429		FN-0037	
	L710V		W/O ABS	98.10 ~ 02.12	HN-429		FN-0020	
			W/ ABS	00. 3 ~ 02.12	HN-429		FN-0036	
	L250S		02.12 ~ 07.10	HN-428			FN-0027	
		TURBO AT	W/ DVS	02.12 ~ 07.10	HN-492		FN-0027	
	L260S		02.12 ~ 07.10	HN-428			FN-0030	
		TURBO AT	W/ DVS	02.12 ~ 07.10	HN-492		FN-0030	
	L250V		02.12 ~ 07.10	HN-428			FN-0027	
	L260V		02.12 ~ 07.10	HN-428			FN-0030	
	L650S	L	W/O ABS	04.11 ~ 09. 3	HN-428		FN-0027	
		L, X	W/ ABS	04.11 ~ 09. 3	HN-428		FN-0042	
	L660S		04.11 ~ 09. 3	HN-428			FN-0030	
	L275S	XLTD	06.12 ~ 13. 2	HN-428			FN-0027	
		CUSTOM RS	06.12 ~ 09. 4	HN-492			FN-0027	
	L275V		07.10 ~ 13. 2	HN-428			FN-0027	
	L285S	XLTD	06.12 ~ 08.12	HN-428			FN-0043	
		CUSTOM RS	06.12 ~	HN-492			FN-0043	
	L285V		07.10 ~ 13. 2	HN-428			FN-0043	
1000	L701S	13inch DISC	02. 8 ~ 03. 8	HN-427			FN-0037	
		12inch DISC	03. 9 ~ 04.10	HN-428			FN-0037	
	L711S	13inch DISC	02. 8 ~ 03. 8	HN-427			FN-0036	
		12inch DISC	03. 9 ~ 04.10	HN-428			FN-0036	
MIRA e:s								
660	LA300S	2WD	11. 8 ~ 13. 7	HN-428			FN-0044	
			13. 7 ~	HN-428				
	LA310S	4WD	11. 8 ~	HN-428			FN-0043	
MIRA COCOA								
660	L675S		09. 8 ~ 14. 8	HN-428			FN-0027	
	L685S		09. 8 ~ 14. 8	HN-428			FN-0043	
MOVE								
660	L600S		95. 8 ~ 98. 9	HN-451			FN-0027	
		TURBO	96. 4 ~ 98. 9	HN-295			FN-0027	
	L602S		95. 8 ~ 96. 4	HN-451			FN-0027	
			96. 4 ~ 98. 9	HN-295			FN-0027	
	L610S	CS	95. 8 ~ 98. 9	HN-451			FN-0025	
		Z4	W/ ABS	96. 4 ~ 98. 9	HN-451		FN-0029	
		SR, TURBO	96. 4 ~ 98. 9	HN-295			FN-0025	
	L900S	CX, CUSTOM L	W/O ABS	98.10 ~ 99. 8	HN-428		FN-0024	
			W/ ABS	98.10 ~ 99. 8	HN-428		FN-0036	
			W/O ABS	99. 9 ~ 99. 9	HN-428		FN-0027	
			W/ ABS	99. 9 ~ 99. 9	HN-428		FN-0036	
			W/O ABS	99.10 ~ 00. 9	HN-428		FN-0040	
			W/ ABS	99.10 ~ 00. 9	HN-428		FN-0037	

NISSAN

TOYOTA
(HINO)

MAZDA

ISUZU

HONDA

MITSUBISHI

SUBARU

SUZUKI

DAIHATSU

LEXUS

INFINITI

HYUNDAI

KIA

DAIHATSU - 11

- NISSAN
- TOYOTA
(HINO)
- MAZDA
- ISUZU
- HONDA
- MITSUBISHI
- SUBARU
- SUZUKI
- DAIHATSU**
- LEXUS
- INFINITI
- HYUNDAI
- KIA

Model 車種形式	Year 年式	Front フロント		Rear リア		Parking パーキング
		Pad パッド	Shoe シュー	Pad パッド	Shoe シュー	Shoe シュー
MOVE						
660 L900S	W/O ABS	00. 9 ~ 02. 9	HN-428			FN-0040
	W/ ABS	00. 9 ~ 02. 9	HN-428			FN-0036
	CR, CXT, TURBO	W/O ABS	98.10 ~ 99. 8	HN-427		FN-0024
		W/ ABS	98.10 ~ 99. 8	HN-427		FN-0036
		W/O ABS	99. 9 ~ 99. 9	HN-427		FN-0027
		W/ ABS	99. 9 ~ 99. 9	HN-427		FN-0036
L900S	W/O ABS	99.10 ~ 02. 9	HN-427			FN-0040
	W/ ABS	99.10 ~ 02. 9	HN-427			FN-0037
L902S	W/O ABS	98.10 ~ 99. 8	HN-427			FN-0024
	W/ ABS	98.10 ~ 99. 8	HN-427			FN-0036
	W/O ABS	99. 9 ~ 99. 9	HN-427			FN-0027
	W/ ABS	99. 9 ~ 99. 9	HN-427			FN-0036
	W/O ABS	99.10 ~ 02. 9	HN-427			FN-0040
	W/ ABS	99.10 ~ 02. 9	HN-427			FN-0037
L910S	CL	W/O ABS	98.10 ~ 02. 9	HN-428		FN-0020
		W/ ABS	98.10 ~ 02. 9	HN-428		FN-0036
	Z4, CUSTOM, PICO	W/O ABS	98.10 ~ 02. 9	HN-427		FN-0020
		W/ ABS	98.10 ~ 02. 9	HN-427		FN-0036
L912S	TURBO	01.10 ~ 02. 9	HN-427			FN-0036
L150S	L	W/O ABS	02.10 ~ 06.10	HN-428		FN-0027
		W/ ABS	02.10 ~ 06.10	HN-428		FN-0042
	X	02.10 ~ 06.10	HN-428			FN-0027
	CUSTOM X	02.10 ~ 06.10	HN-428			FN-0042
	TURBO	W/ DVS	02.10 ~ 06.10	HN-492		FN-0042
L152S	TURBO	02.10 ~ 06.10	HN-492			FN-0042
L160S	INCL. CUSTOM	02.10 ~ 06.10	HN-428			FN-0030
	CUSTOM RS, TURBO	02.10 ~ 06.10	HN-492			FN-0030
L175S	L	W/O ABS	06.10 ~ 10.12	HN-428		FN-0027
	L, X	W/ ABS	06.10 ~ 10.12	HN-428		FN-0042
	RS	W/ DVS	06.10 ~ 10.12	HN-443		FN-0042
	RS	W/O DVS	06.10 ~ 10.12	HN-492		FN-0042
L185S	L, R, X	06.10 ~ 10.12	HN-428			FN-0043
	CUSTOM RS	06.10 ~ 10.12	HN-492			FN-0043
LA100S		10.12 ~ 14.12	※			※
※FRONT PAD HN-428orHN-492, REAR SHOE FN-0042orFN-2397						
LA110S		10.12 ~ 14.12	※			FN-0043
※FRONT PAD HN-428orHN-492						
MOVE CONTE						
660 L575S	RS 13inch ventilated disc lotor	08. 8 ~	HN-492			FN-0027
		08. 8 ~ 13. 7	HN-428			FN-0027
		13. 7 ~	HN-492			FN-2397
L585S		08. 8 ~ 13. 7	HN-428			FN-0043
		13. 7 ~	HN-492			FN-0043
	CUSTOM RS, W/TURBO	08. 8 ~	HN-492			FN-0043
MOVE LATTE						
660 L550S	L	W/O ABS	04. 8 ~ 09. 3	HN-428		FN-0027
	L, RS, X	W/ ABS	04. 8 ~ 09. 3	HN-428		FN-0042

DAIHATSU - 12

Model 車種形式		Year 年式	Front フロント		Rear リア		Parking パーキング
			Pad パッド	Shoe シュー	Pad パッド	Shoe シュー	Shoe シュー
MOVE LATTE							
660	L560S	04. 8 ~ 09. 3	HN-428				FN-0030
	RS	05. 8 ~ 09. 3	HN-492				FN-0030
RUGGER							
2800	F70, F70V	89.10 ~ 93. 4	HN-291				FN-0022
	F75V	89.10 ~ 93. 4	HN-291				FN-0022
	F71G, F76G	89.10 ~ 93. 4	HN-291				FN-0022
	F73G, F78G	93. 5 ~ 97. 5	HN-291				FN-2317
LEEZA							
660	L100V	86.11 ~ 92. 7	HN-295	FN-0026			FN-0024
	L100S S1	86.11 ~ 92. 7	HN-295	FN-0026			FN-0024
	TD, TS	86.11 ~ 92. 7	HN-295	FN-0026			FN-0027
	L111S	86.11 ~ 92. 7	HN-451	FN-0026			FN-0024
ROCKY							
1600	F300S	90. 7 ~ 97. 5	HN-291				FN-0022

- NISSAN
- TOYOTA (HINO)
- MAZDA
- ISUZU
- HONDA
- mitsubishi
- SUBARU
- SUZUKI
- DAIHATSU**
- LEXUS
- INFINITI
- HYUNDAI
- KIA

DAIHATSU - 13

	Model 車種形式	Year 年式	Front フロント		Rear リア		Parking パーキング
			Pad パッド	Shoe シュー	Pad パッド	Shoe シュー	Shoe シュー
NISSAN							
TOYOTA (HINO)							
MAZDA							
ISUZU							
HONDA							
MITSUBISHI							
SUBARU							
SUZUKI							
DAIHATSU							
LEXUS							
INFINITY							
HYUNDAI							
KIA							

LEXUS - 1

Model 車種形式	Year 年式	Front フロント		Rear リア		Parking パーキング
		Pad パッド	Shoe シュー	Pad パッド	Shoe シュー	Shoe シュー
ES350						
GSV40	07.01 ~ 09.12	HN-521		HN-522		
HS250H						
	09.07 ~ 12.01	HN-524		HN-522		FN-1299
IS250						
2200 DBA-GSE21	05.10 ~	HN-912		HN-494		
2500 DBA-GSE 20/25	05.10 ~	HN-912		HN-494		
GSE20/GSE21	06.01 ~	HN-912		HN-494		
IS350						
3500 GSE20, 25	05.08 ~	HN-912		HN-494		
LS460						
4600 DBA-USF40, 41	06.06 ~ 09.12	HN-928		HN-945		
5000 DAA-UVF45, 46	07.01 ~ 09.12	HN-928		HN-945		
LEXUS CT						
1800 ZWA10 CT200h	11. 1 ~ 13. 5	HN-567		HN-568		
LEXUS GS						
3500 GRL10 GS350	12. 1 ~	HN-547				
GWL10 GS450H	12. 1 ~	HN-547				
RX300						
MCU15	00.07 ~ 02.06	HN-455		HN-456		FN-2901

NISSAN

TOYOTA
(HINO)

MAZDA

ISUZU

HONDA

MITSUBISHI

SUBARU

SUZUKI

DAIHATSU

LEXUS

INFINITI

HYUNDAI

KIA

INFINITY - 1

- NISSAN
- TOYOTA
(HINO)
- MAZDA
- ISUZU
- HONDA
- MITSUBISHI
- SUBARU
- SUZUKI
- DAIHATSU
- INFINITY
- HYUNDAI
- KIA

Model 車種形式	Year 年式	Front フロント		Rear リア		Parking パーキング
		Pad パッド	Shoe シュー	Pad パッド	Shoe シュー	Shoe シュー
EX25/35/37						
3500 J50	07.11 ~	HN-936		HN-466		
FX35						
	05 ~ 06					FN-1901
FX35/FX45/FX50						
3500 S50	03.01 ~ 05.01	HN-958				
FX45						
4500 S50	03.02 ~	HN-958				
Q50						
3500 HNV37 , HV37	Hybrid 14.02 ~	HN-621		HN-565		
QX56(ARMADA)						
5600	04.01 ~ 09.12	HN-961		HN-920		
	07.01 ~ 09.12			HN-920		
Z62	10.04 ~	HN-973 or NA		HN-973 or NA		
QX56						
5600	10.03 ~			HN-979 or NA		

HYUNDAI - 1

Model 車種形式	Year 年式	Front フロント		Rear リア		Parking パーキング
		Pad パッド	Shoe シュー	Pad パッド	Shoe シュー	Shoe シュー
ACCENT/ACCENT BLUE/VERNA/PONY EXCEL						
	95 ~ 99					FN-11162
	99.06 ~					FN-11165
	02.11 ~					FN-11189
	07.01 ~ 11.11					FN-11182
1400cc, 1500cc, 1600cc	06.01 ~ 12.02			HN-986 or NA		
ATOS/ATOS PRIME						
	97 ~ 08.01					FN-11162
COUNTY						
3900 HD65, 72, 78	04.09 ~					FN-K905
ERANTRA/LANTRA						
	91 ~ 11.05					FN-11189
	90 ~ 06					FN-11158
GETZ/I 20						
	02.05 ~					FN-11182
	02.05 ~					FN-11186
H1 STAREX /CARGO						
2400	08.02 ~	HN-905				
2500	08.01 ~	HN-905				
KMF, KMJ, HY	08.02 ~	HN-905				
H-1 CARGO	11.08 ~	HN-905				
H1 STAREX						
	01.11 ~			HN-983		
MATRIX/LAVITA						
	01.05 ~					FN-11189
SANTA FE						
	00.08 ~ 06.09					FN-11179
	01 ~					FN-K902
	09 11~			HN-984		
SONATA/SONATA NF/SONICA						
	89 ~ 98					FN-11141
2000cc~3300cc	98.05 ~ 07.12			HN-987 or NA		
SANTRO						
	98 ~					FN-11162
TERRACAN						
	01 ~ 12					FN-K901

- NISSAN
- TOYOTA
(HINO)
- MAZDA
- ISUZU
- HONDA
- MITSUBISHI
- SUBARU
- SUZUKI
- DAIHATSU
- LEXUS
- INFINITY
- HYUNDAI**
- KIA

KIA - 1

- NISSAN
- TOYOTA
(HINO)
- MAZDA
- ISUZU
- HONDA
- MITSUBISHI
- SUBARU
- SUZUKI
- DAIHATSU
- LEXUS
- INFINITY
- HYUNDAI
- KIA

Model 車種形式	Year 年式	Front フロント		Rear リア		Parking パーキング
		Pad パッド	Shoe シュー	Pad パッド	Shoe シュー	Shoe シュー
CARNIVAL Ⅲ						
2200	10.01 ~	HN-905				
CARNIVAL/SEDONA						
2700	6.07 ~ 09.12	HN-905				
2900	6.07 ~ 09.12	HN-905				
MORNING						
	4.03 ~				FN-11192 or others	
NAZA RIA						
2500	4.01 ~	HN-905				
SORENTO						
	03.01 ~ 06.12				HN-983	
	09.05 ~ 15.06				HN-984	

BRAKE SHOE ASSY



ILLUSTRATIONS

- a: Web Thickness
- b: Rim Thickness
- c: Lining Width
- r: Radius

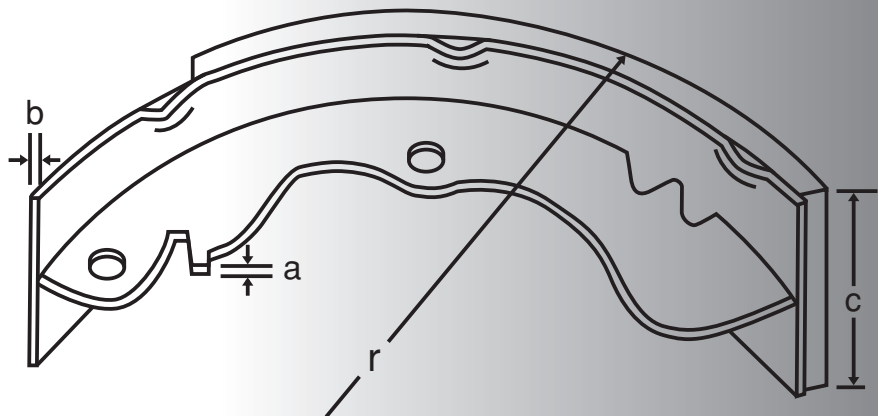

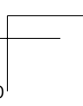
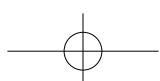
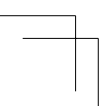
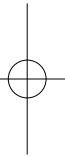
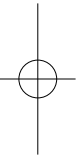
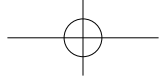
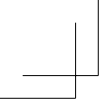

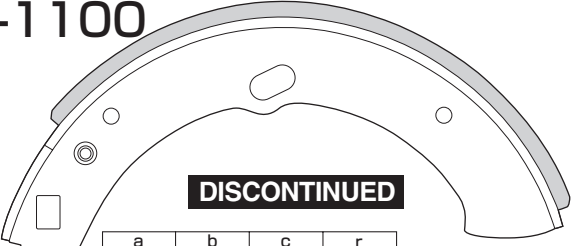
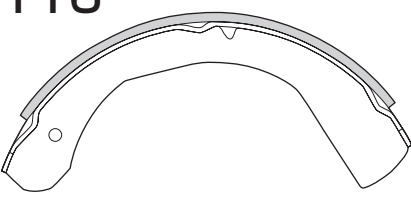
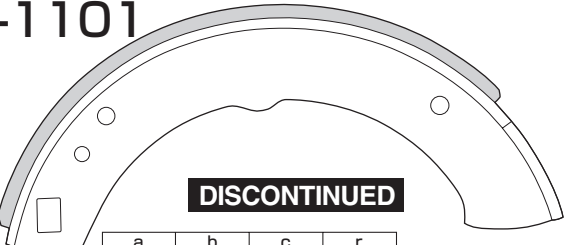
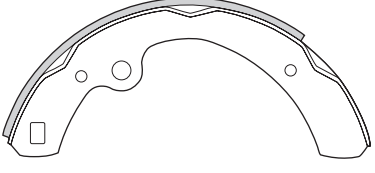
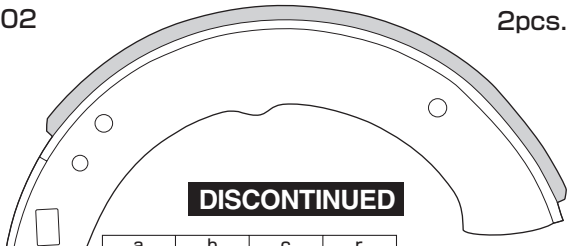
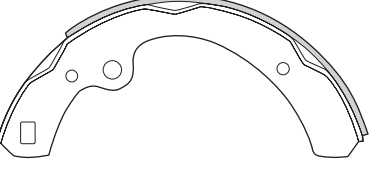
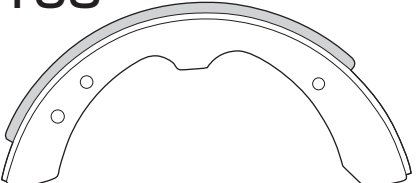
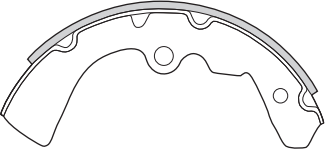
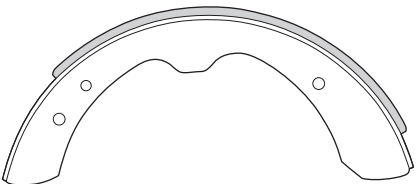
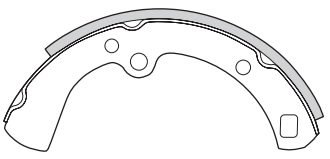
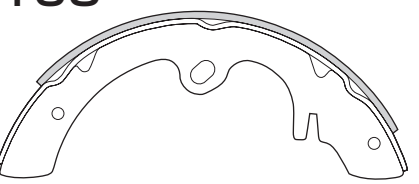
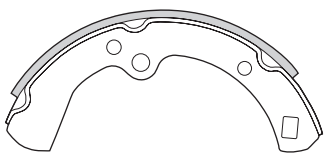

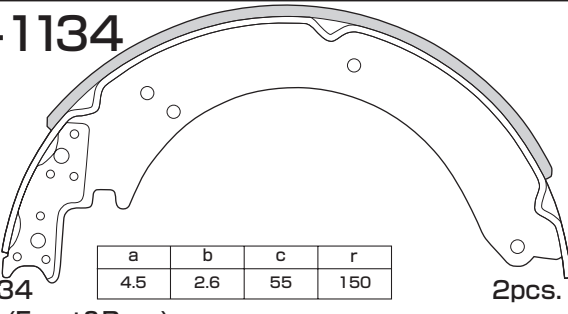
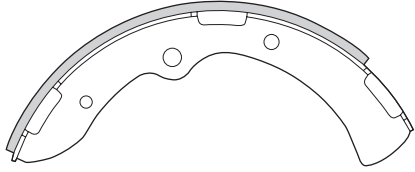
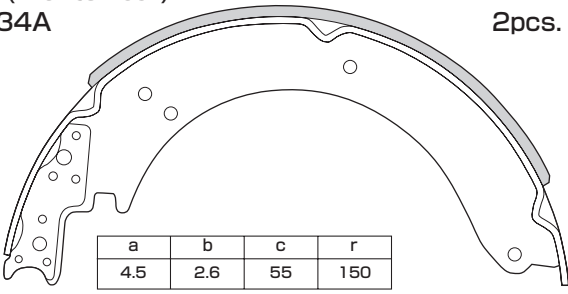
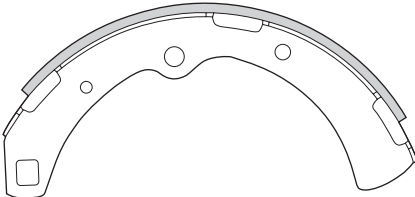
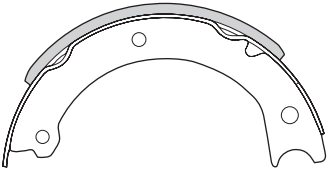
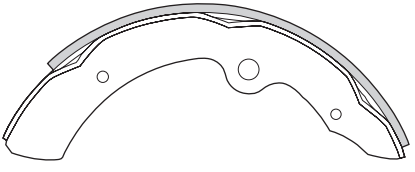
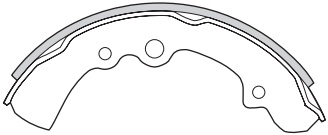
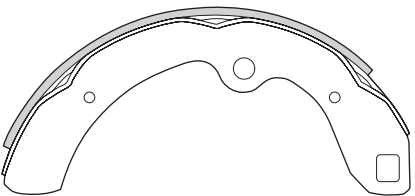
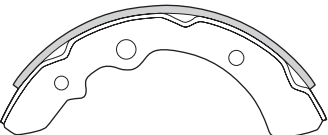
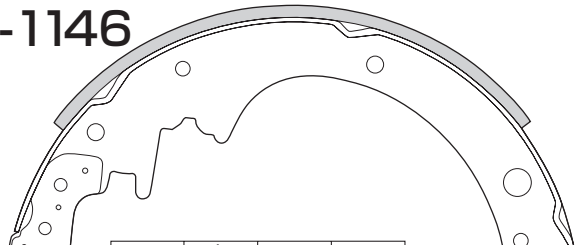
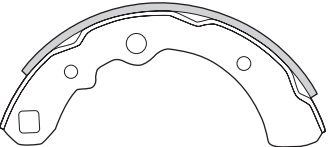
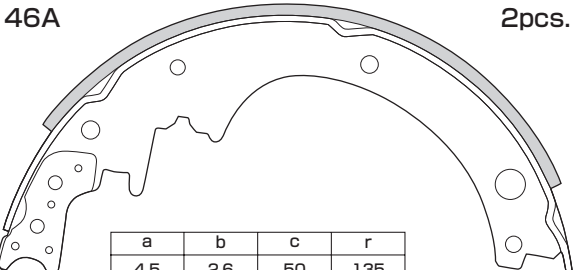

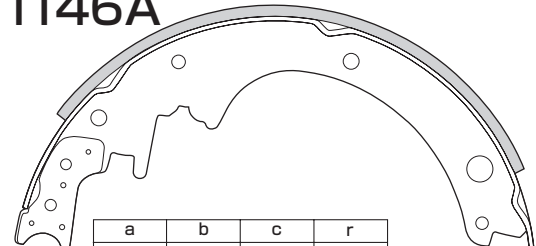
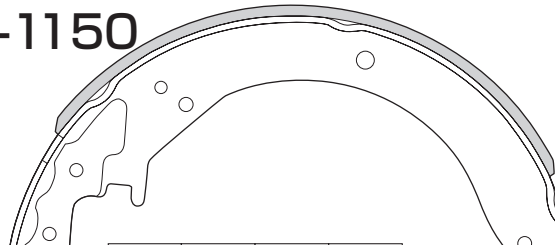
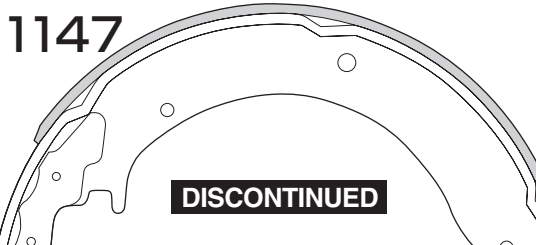
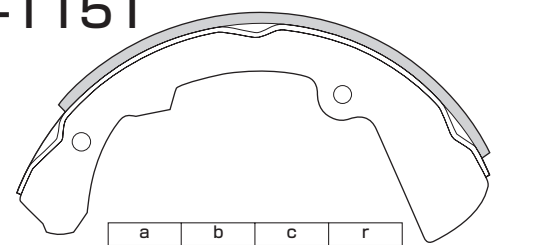
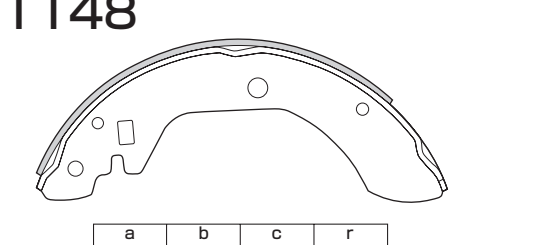
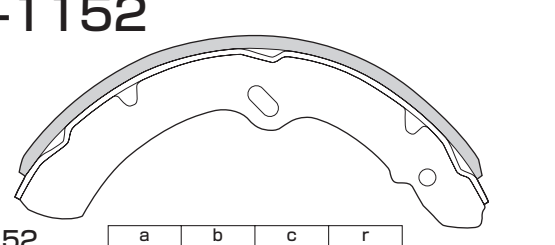
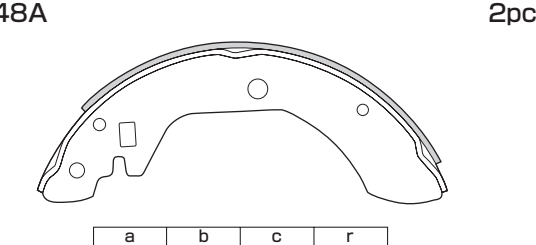
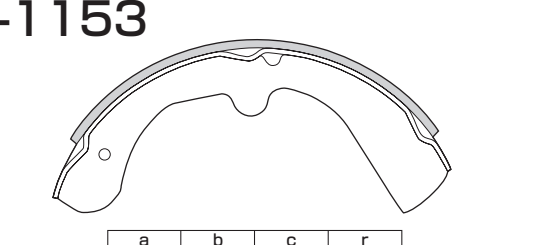
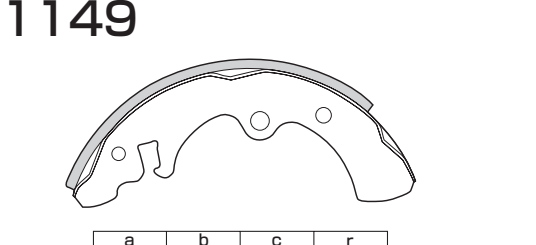
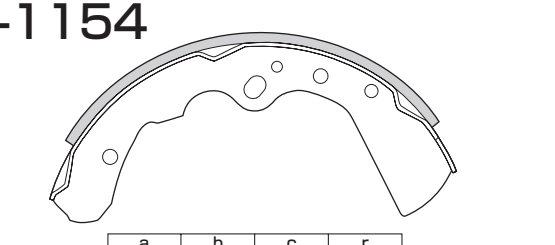
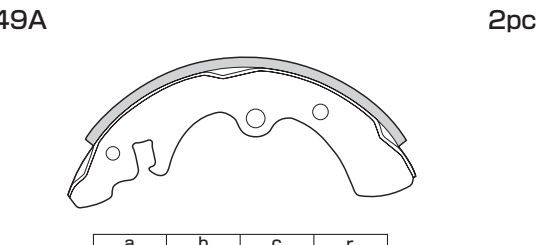
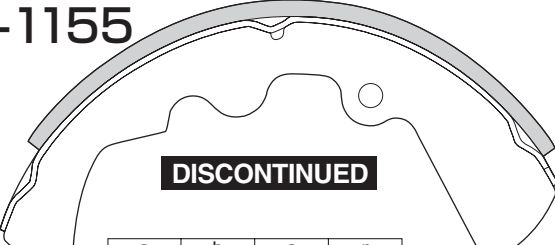
<p>FN-1100</p>  <p>DISCONTINUED</p> <table border="1" data-bbox="412 523 707 584"> <thead> <tr> <th>a</th> <th>b</th> <th>c</th> <th>r</th> </tr> </thead> <tbody> <tr> <td>4.5</td> <td>4.5</td> <td>55</td> <td>146</td> </tr> </tbody> </table> <p>LN1100(Front) 4pcs.</p>	a	b	c	r	4.5	4.5	55	146	<p>FN-1116</p>  <table border="1" data-bbox="1093 523 1388 584"> <thead> <tr> <th>a</th> <th>b</th> <th>c</th> <th>r</th> </tr> </thead> <tbody> <tr> <td>3.2</td> <td>2</td> <td>40</td> <td>114.3</td> </tr> </tbody> </table> <p>LN1116(Front) 4pcs.</p>	a	b	c	r	3.2	2	40	114.3
a	b	c	r														
4.5	4.5	55	146														
a	b	c	r														
3.2	2	40	114.3														
<p>FN-1101</p>  <p>DISCONTINUED</p> <table border="1" data-bbox="412 840 707 901"> <thead> <tr> <th>a</th> <th>b</th> <th>c</th> <th>r</th> </tr> </thead> <tbody> <tr> <td>4.5</td> <td>4.5</td> <td>55</td> <td>146</td> </tr> </tbody> </table> <p>LN1101 (Rear) 2pcs.</p>	a	b	c	r	4.5	4.5	55	146	<p>FN-1119</p>  <table border="1" data-bbox="1093 840 1388 901"> <thead> <tr> <th>a</th> <th>b</th> <th>c</th> <th>r</th> </tr> </thead> <tbody> <tr> <td>3.2</td> <td>2</td> <td>40</td> <td>114.3</td> </tr> </tbody> </table> <p>LN1119 (Rear) 2pcs.</p>	a	b	c	r	3.2	2	40	114.3
a	b	c	r														
4.5	4.5	55	146														
a	b	c	r														
3.2	2	40	114.3														
<p>FN-1102</p>  <p>DISCONTINUED</p> <table border="1" data-bbox="412 1157 707 1218"> <thead> <tr> <th>a</th> <th>b</th> <th>c</th> <th>r</th> </tr> </thead> <tbody> <tr> <td>4.5</td> <td>4.5</td> <td>55</td> <td>146</td> </tr> </tbody> </table> <p>LN1102 2pcs.</p>	a	b	c	r	4.5	4.5	55	146	<p>FN-1120</p>  <table border="1" data-bbox="1093 1157 1388 1218"> <thead> <tr> <th>a</th> <th>b</th> <th>c</th> <th>r</th> </tr> </thead> <tbody> <tr> <td>3.2</td> <td>2</td> <td>40</td> <td>114.3</td> </tr> </tbody> </table> <p>LN1120 2pcs.</p>	a	b	c	r	3.2	2	40	114.3
a	b	c	r														
4.5	4.5	55	146														
a	b	c	r														
3.2	2	40	114.3														
<p>FN-1103</p>  <table border="1" data-bbox="412 1473 707 1534"> <thead> <tr> <th>a</th> <th>b</th> <th>c</th> <th>r</th> </tr> </thead> <tbody> <tr> <td>4.5</td> <td>2.3</td> <td>45</td> <td>127</td> </tr> </tbody> </table> <p>LN1103 (Front) 2pcs.</p>	a	b	c	r	4.5	2.3	45	127	<p>FN-1121</p>  <table border="1" data-bbox="1093 1473 1388 1534"> <thead> <tr> <th>a</th> <th>b</th> <th>c</th> <th>r</th> </tr> </thead> <tbody> <tr> <td>3.2</td> <td>1.6</td> <td>35</td> <td>101.6</td> </tr> </tbody> </table> <p>LN1121(Front) 4pcs.</p>	a	b	c	r	3.2	1.6	35	101.6
a	b	c	r														
4.5	2.3	45	127														
a	b	c	r														
3.2	1.6	35	101.6														
<p>FN-1104</p>  <table border="1" data-bbox="412 1790 707 1851"> <thead> <tr> <th>a</th> <th>b</th> <th>c</th> <th>r</th> </tr> </thead> <tbody> <tr> <td>4.5</td> <td>2.3</td> <td>45</td> <td>127</td> </tr> </tbody> </table> <p>LN1104 2pcs.</p>	a	b	c	r	4.5	2.3	45	127	<p>FN-1122</p>  <table border="1" data-bbox="1093 1790 1388 1851"> <thead> <tr> <th>a</th> <th>b</th> <th>c</th> <th>r</th> </tr> </thead> <tbody> <tr> <td>3.2</td> <td>1.6</td> <td>35</td> <td>101.6</td> </tr> </tbody> </table> <p>LN1122 (Rear) 2pcs.</p>	a	b	c	r	3.2	1.6	35	101.6
a	b	c	r														
4.5	2.3	45	127														
a	b	c	r														
3.2	1.6	35	101.6														
<p>FN-1105</p>  <table border="1" data-bbox="412 2119 707 2180"> <thead> <tr> <th>a</th> <th>b</th> <th>c</th> <th>r</th> </tr> </thead> <tbody> <tr> <td>4.5</td> <td>2.3</td> <td>45</td> <td>127</td> </tr> </tbody> </table> <p>LN1105(Rear) 4pcs.</p>	a	b	c	r	4.5	2.3	45	127	<p>FN-1123</p>  <table border="1" data-bbox="1093 2107 1388 2168"> <thead> <tr> <th>a</th> <th>b</th> <th>c</th> <th>r</th> </tr> </thead> <tbody> <tr> <td>3.2</td> <td>1.6</td> <td>35</td> <td>101.6</td> </tr> </tbody> </table> <p>LN1123 2pcs.</p>	a	b	c	r	3.2	1.6	35	101.6
a	b	c	r														
4.5	2.3	45	127														
a	b	c	r														
3.2	1.6	35	101.6														

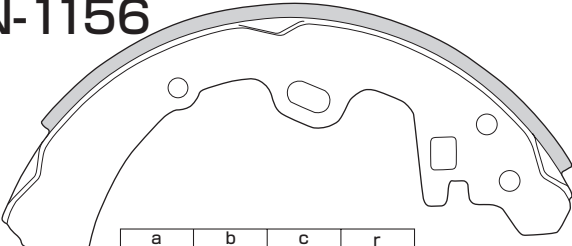
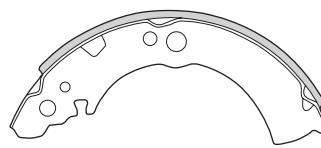
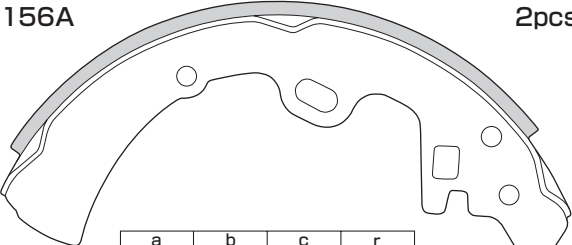
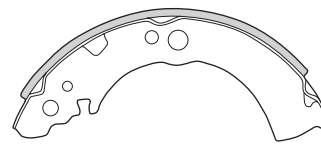
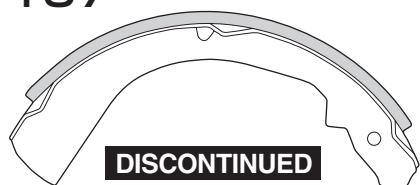
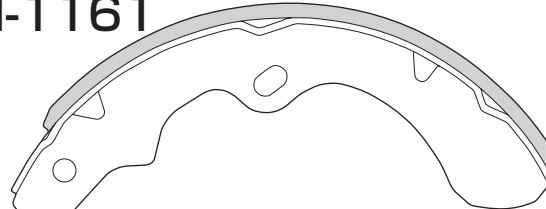
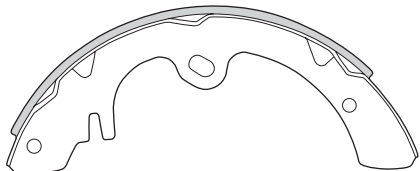
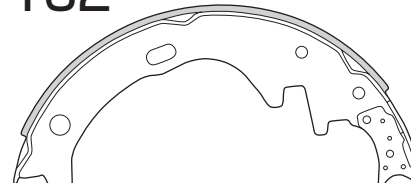
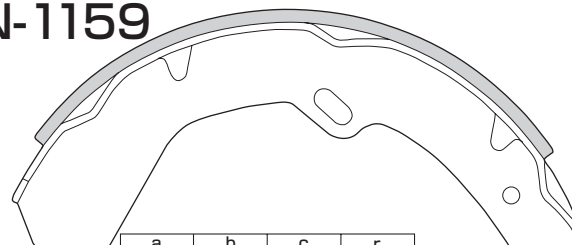
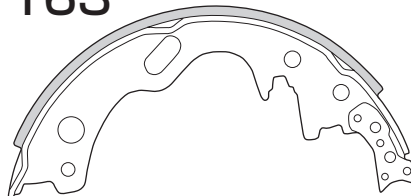
<p>FN-1134</p>  <p>LN1134 (Front&Rear)</p> <table border="1" data-bbox="413 531 713 587"> <thead> <tr> <th>a</th> <th>b</th> <th>c</th> <th>r</th> </tr> </thead> <tbody> <tr> <td>4.5</td> <td>2.6</td> <td>55</td> <td>150</td> </tr> </tbody> </table> <p>2pcs.</p>	a	b	c	r	4.5	2.6	55	150	<p>FN-1140</p>  <p>LN1140 (Rear)</p> <table border="1" data-bbox="1089 531 1388 587"> <thead> <tr> <th>a</th> <th>b</th> <th>c</th> <th>r</th> </tr> </thead> <tbody> <tr> <td>4.5</td> <td>2.3</td> <td>50</td> <td>120.65</td> </tr> </tbody> </table> <p>2pcs.</p>	a	b	c	r	4.5	2.3	50	120.65
a	b	c	r														
4.5	2.6	55	150														
a	b	c	r														
4.5	2.3	50	120.65														
<p>LN1134A</p>  <table border="1" data-bbox="413 847 713 903"> <thead> <tr> <th>a</th> <th>b</th> <th>c</th> <th>r</th> </tr> </thead> <tbody> <tr> <td>4.5</td> <td>2.6</td> <td>55</td> <td>150</td> </tr> </tbody> </table> <p>2pcs.</p>	a	b	c	r	4.5	2.6	55	150	<p>LN1141</p>  <table border="1" data-bbox="1089 847 1388 903"> <thead> <tr> <th>a</th> <th>b</th> <th>c</th> <th>r</th> </tr> </thead> <tbody> <tr> <td>4.5</td> <td>2.3</td> <td>50</td> <td>120.65</td> </tr> </tbody> </table> <p>2pcs.</p>	a	b	c	r	4.5	2.3	50	120.65
a	b	c	r														
4.5	2.6	55	150														
a	b	c	r														
4.5	2.3	50	120.65														
<p>FN-1135</p>  <p>LN1135 (Parking)</p> <table border="1" data-bbox="413 1171 713 1227"> <thead> <tr> <th>a</th> <th>b</th> <th>c</th> <th>r</th> </tr> </thead> <tbody> <tr> <td>4.5</td> <td>1.6</td> <td>35</td> <td>80</td> </tr> </tbody> </table> <p>2pcs.</p>	a	b	c	r	4.5	1.6	35	80	<p>FN-1143</p>  <p>LN1143 (Rear)</p> <table border="1" data-bbox="1089 1171 1388 1227"> <thead> <tr> <th>a</th> <th>b</th> <th>c</th> <th>r</th> </tr> </thead> <tbody> <tr> <td>3.2</td> <td>2</td> <td>40</td> <td>114.3</td> </tr> </tbody> </table> <p>2pcs.</p>	a	b	c	r	3.2	2	40	114.3
a	b	c	r														
4.5	1.6	35	80														
a	b	c	r														
3.2	2	40	114.3														
<p>FN-1136</p>  <p>LN1136(Front)</p> <table border="1" data-bbox="413 1488 713 1544"> <thead> <tr> <th>a</th> <th>b</th> <th>c</th> <th>r</th> </tr> </thead> <tbody> <tr> <td>3.2</td> <td>2.6</td> <td>35</td> <td>101.6</td> </tr> </tbody> </table> <p>4pcs.</p>	a	b	c	r	3.2	2.6	35	101.6	<p>LN1144</p>  <table border="1" data-bbox="1089 1488 1388 1544"> <thead> <tr> <th>a</th> <th>b</th> <th>c</th> <th>r</th> </tr> </thead> <tbody> <tr> <td>3.2</td> <td>2</td> <td>40</td> <td>114.3</td> </tr> </tbody> </table> <p>2pcs.</p>	a	b	c	r	3.2	2	40	114.3
a	b	c	r														
3.2	2.6	35	101.6														
a	b	c	r														
3.2	2	40	114.3														
<p>FN-1137</p>  <p>LN1137 (Rear)</p> <table border="1" data-bbox="413 1805 713 1861"> <thead> <tr> <th>a</th> <th>b</th> <th>c</th> <th>r</th> </tr> </thead> <tbody> <tr> <td>3.2</td> <td>1.6</td> <td>30</td> <td>90</td> </tr> </tbody> </table> <p>2pcs.</p>	a	b	c	r	3.2	1.6	30	90	<p>FN-1146</p>  <p>LN1146 (Rear)</p> <table border="1" data-bbox="1089 1805 1388 1861"> <thead> <tr> <th>a</th> <th>b</th> <th>c</th> <th>r</th> </tr> </thead> <tbody> <tr> <td>4.5</td> <td>2.6</td> <td>50</td> <td>135</td> </tr> </tbody> </table> <p>2pcs.</p>	a	b	c	r	4.5	2.6	50	135
a	b	c	r														
3.2	1.6	30	90														
a	b	c	r														
4.5	2.6	50	135														
<p>LN1138</p>  <table border="1" data-bbox="413 2121 713 2177"> <thead> <tr> <th>a</th> <th>b</th> <th>c</th> <th>r</th> </tr> </thead> <tbody> <tr> <td>3.2</td> <td>1.6</td> <td>30</td> <td>90</td> </tr> </tbody> </table> <p>2pcs.</p>	a	b	c	r	3.2	1.6	30	90	<p>LN1146A</p>  <table border="1" data-bbox="1089 2121 1388 2177"> <thead> <tr> <th>a</th> <th>b</th> <th>c</th> <th>r</th> </tr> </thead> <tbody> <tr> <td>4.5</td> <td>2.6</td> <td>50</td> <td>135</td> </tr> </tbody> </table> <p>2pcs.</p>	a	b	c	r	4.5	2.6	50	135
a	b	c	r														
3.2	1.6	30	90														
a	b	c	r														
4.5	2.6	50	135														

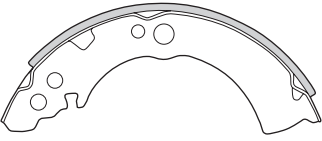
<h3>FN-1146A</h3>  <p>LN1146A(Rear) <table border="1" data-bbox="412 523 707 584"><tr><th>a</th><th>b</th><th>c</th><th>r</th></tr><tr><td>4.5</td><td>2.6</td><td>50</td><td>135</td></tr></table> 4pcs.</p>	a	b	c	r	4.5	2.6	50	135	<h3>FN-1150</h3>  <p>LN1150 (Front & Rear) <table border="1" data-bbox="1084 523 1379 584"><tr><th>a</th><th>b</th><th>c</th><th>r</th></tr><tr><td>4.5</td><td>3.2</td><td>55</td><td>150</td></tr></table> 4pcs.</p>	a	b	c	r	4.5	3.2	55	150
a	b	c	r														
4.5	2.6	50	135														
a	b	c	r														
4.5	3.2	55	150														
<h3>FN-1147</h3>  <p>DISCONTINUED</p> <p>LN1147(Front) <table border="1" data-bbox="412 840 707 901"><tr><th>a</th><th>b</th><th>c</th><th>r</th></tr><tr><td>4.5</td><td>4.5</td><td>70</td><td>150</td></tr></table> 4pcs.</p>	a	b	c	r	4.5	4.5	70	150	<h3>FN-1151</h3>  <p>LN1151 (Front) <table border="1" data-bbox="1084 840 1379 901"><tr><th>a</th><th>b</th><th>c</th><th>r</th></tr><tr><td>4.5</td><td>2.3</td><td>50</td><td>130</td></tr></table> 4pcs.</p>	a	b	c	r	4.5	2.3	50	130
a	b	c	r														
4.5	4.5	70	150														
a	b	c	r														
4.5	2.3	50	130														
<h3>FN-1148</h3>  <p>LN1148 (Rear) <table border="1" data-bbox="412 1157 707 1218"><tr><th>a</th><th>b</th><th>c</th><th>r</th></tr><tr><td>3.2</td><td>2</td><td>40</td><td>114.3</td></tr></table> 2pcs.</p>	a	b	c	r	3.2	2	40	114.3	<h3>FN-1152</h3>  <p>LN1152 (Front & Rear) <table border="1" data-bbox="1084 1157 1379 1218"><tr><th>a</th><th>b</th><th>c</th><th>r</th></tr><tr><td>6</td><td>3.2</td><td>65</td><td>160</td></tr></table> 4pcs.</p>	a	b	c	r	6	3.2	65	160
a	b	c	r														
3.2	2	40	114.3														
a	b	c	r														
6	3.2	65	160														
<h3>FN-1148A</h3>  <p>LN1148A (Rear) <table border="1" data-bbox="412 1473 707 1534"><tr><th>a</th><th>b</th><th>c</th><th>r</th></tr><tr><td>3.2</td><td>2</td><td>40</td><td>114.3</td></tr></table> 2pcs.</p>	a	b	c	r	3.2	2	40	114.3	<h3>FN-1153</h3>  <p>LN1153(Front) <table border="1" data-bbox="1084 1473 1379 1534"><tr><th>a</th><th>b</th><th>c</th><th>r</th></tr><tr><td>4.5</td><td>2</td><td>40</td><td>114.3</td></tr></table> 4pcs.</p>	a	b	c	r	4.5	2	40	114.3
a	b	c	r														
3.2	2	40	114.3														
a	b	c	r														
4.5	2	40	114.3														
<h3>FN-1149</h3>  <p>LN1149 (Rear) <table border="1" data-bbox="412 1790 707 1851"><tr><th>a</th><th>b</th><th>c</th><th>r</th></tr><tr><td>3.2</td><td>1.6</td><td>35</td><td>101.6</td></tr></table> 2pcs.</p>	a	b	c	r	3.2	1.6	35	101.6	<h3>FN-1154</h3>  <p>LN1154(Front) <table border="1" data-bbox="1084 1790 1379 1851"><tr><th>a</th><th>b</th><th>c</th><th>r</th></tr><tr><td>4.5</td><td>2.3</td><td>50</td><td>120.65</td></tr></table> 4pcs.</p>	a	b	c	r	4.5	2.3	50	120.65
a	b	c	r														
3.2	1.6	35	101.6														
a	b	c	r														
4.5	2.3	50	120.65														
<h3>FN-1149A</h3>  <p>LN1149A (Rear) <table border="1" data-bbox="412 2107 707 2168"><tr><th>a</th><th>b</th><th>c</th><th>r</th></tr><tr><td>3.2</td><td>1.6</td><td>35</td><td>101.6</td></tr></table> 2pcs.</p>	a	b	c	r	3.2	1.6	35	101.6	<h3>FN-1155</h3>  <p>DISCONTINUED</p> <p>LN1155(Front) <table border="1" data-bbox="1084 2107 1379 2168"><tr><th>a</th><th>b</th><th>c</th><th>r</th></tr><tr><td>4.5</td><td>2.3</td><td>50</td><td>130</td></tr></table> 4pcs.</p>	a	b	c	r	4.5	2.3	50	130
a	b	c	r														
3.2	1.6	35	101.6														
a	b	c	r														
4.5	2.3	50	130														

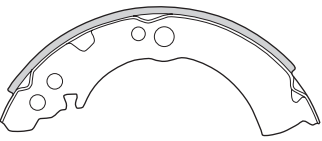
<p>FN-1156</p>  <p>LN1156 (Rear) <table border="1" data-bbox="412 523 707 584"><tr><th>a</th><th>b</th><th>c</th><th>r</th></tr><tr><td>4.5</td><td>2.3</td><td>50</td><td>130</td></tr></table> 2pcs.</p>	a	b	c	r	4.5	2.3	50	130	<p>FN-1160</p>  <p>LN1160 (Rear) <table border="1" data-bbox="1084 523 1379 584"><tr><th>a</th><th>b</th><th>c</th><th>r</th></tr><tr><td>3.2</td><td>1.6</td><td>35</td><td>90</td></tr></table> 2pcs.</p>	a	b	c	r	3.2	1.6	35	90
a	b	c	r														
4.5	2.3	50	130														
a	b	c	r														
3.2	1.6	35	90														
<p>LN1156A</p>  <p><table border="1" data-bbox="412 840 707 901"><tr><th>a</th><th>b</th><th>c</th><th>r</th></tr><tr><td>4.5</td><td>2.3</td><td>50</td><td>130</td></tr></table> 2pcs.</p>	a	b	c	r	4.5	2.3	50	130	<p>LN1160A</p>  <p><table border="1" data-bbox="1084 840 1379 901"><tr><th>a</th><th>b</th><th>c</th><th>r</th></tr><tr><td>3.2</td><td>1.6</td><td>35</td><td>90</td></tr></table> 2pcs.</p>	a	b	c	r	3.2	1.6	35	90
a	b	c	r														
4.5	2.3	50	130														
a	b	c	r														
3.2	1.6	35	90														
<p>FN-1157</p>  <p>LN1157(Front) <table border="1" data-bbox="412 1169 707 1230"><tr><th>a</th><th>b</th><th>c</th><th>r</th></tr><tr><td>4</td><td>2</td><td>40</td><td>114.3</td></tr></table> 4pcs.</p>	a	b	c	r	4	2	40	114.3	<p>FN-1161</p>  <p>LN1161 (Front & Rear) <table border="1" data-bbox="1084 1169 1379 1230"><tr><th>a</th><th>b</th><th>c</th><th>r</th></tr><tr><td>6</td><td>3.2</td><td>75</td><td>150</td></tr></table> 4pcs.</p>	a	b	c	r	6	3.2	75	150
a	b	c	r														
4	2	40	114.3														
a	b	c	r														
6	3.2	75	150														
<p>FN-1158</p>  <p>LN1158(Rear) <table border="1" data-bbox="412 1485 707 1546"><tr><th>a</th><th>b</th><th>c</th><th>r</th></tr><tr><td>4.5</td><td>2.3</td><td>45</td><td>127</td></tr></table> 4pcs.</p>	a	b	c	r	4.5	2.3	45	127	<p>FN-1162</p>  <p>LN1162(Rear) <table border="1" data-bbox="1084 1485 1379 1546"><tr><th>a</th><th>b</th><th>c</th><th>r</th></tr><tr><td>4.5</td><td>2.3</td><td>45</td><td>127</td></tr></table> 4pcs.</p>	a	b	c	r	4.5	2.3	45	127
a	b	c	r														
4.5	2.3	45	127														
a	b	c	r														
4.5	2.3	45	127														
<p>FN-1159</p>  <p>LN1159(Front) <table border="1" data-bbox="412 1802 707 1863"><tr><th>a</th><th>b</th><th>c</th><th>r</th></tr><tr><td>4.5</td><td>3.2</td><td>60</td><td>140</td></tr></table> 4pcs.</p>	a	b	c	r	4.5	3.2	60	140	<p>FN-1163</p>  <p>LN1163(Rear) <table border="1" data-bbox="1084 1802 1379 1863"><tr><th>a</th><th>b</th><th>c</th><th>r</th></tr><tr><td>4.5</td><td>2.6</td><td>60</td><td>110</td></tr></table> 4pcs.</p>	a	b	c	r	4.5	2.6	60	110
a	b	c	r														
4.5	3.2	60	140														
a	b	c	r														
4.5	2.6	60	110														

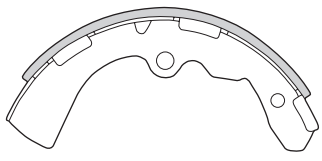
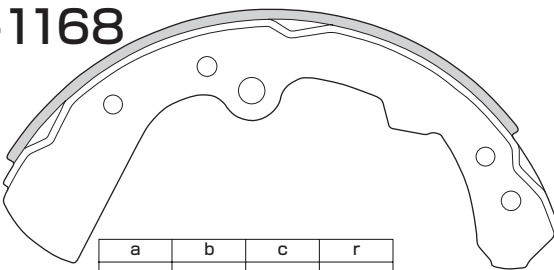
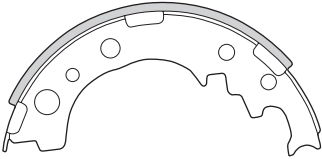
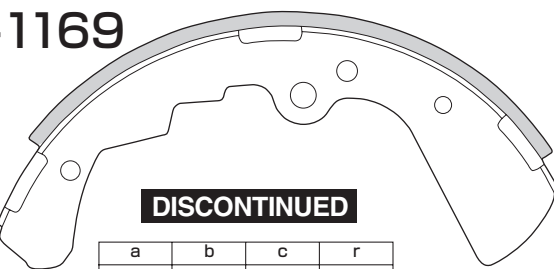
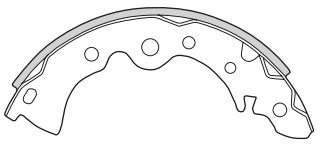
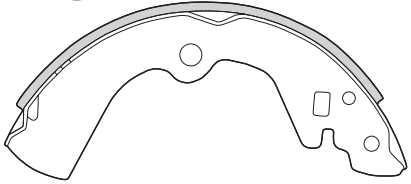
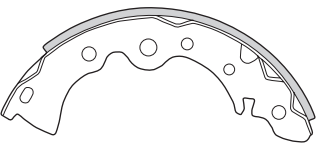
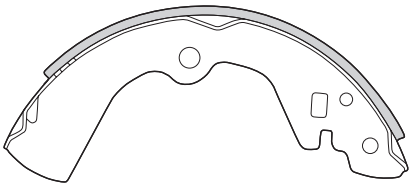
<h3>FN-1164</h3>  <p>LN1164 (Rear) 2pcs.</p> <table border="1" data-bbox="412 531 713 584"> <tr><th>a</th><th>b</th><th>c</th><th>r</th></tr> <tr><td>3.2</td><td>1.6</td><td>25</td><td>90</td></tr> </table>	a	b	c	r	3.2	1.6	25	90	<h3>FN-1167M</h3> <p>Superseded by FN-1167</p>  <p>LN1167M (Rear) 2pcs.</p> <table border="1" data-bbox="1089 531 1388 584"> <tr><th>a</th><th>b</th><th>c</th><th>r</th></tr> <tr><td>3.2</td><td>1.6</td><td>35</td><td>101.4</td></tr> </table>	a	b	c	r	3.2	1.6	35	101.4
a	b	c	r														
3.2	1.6	25	90														
a	b	c	r														
3.2	1.6	35	101.4														
<h3>FN-1164A</h3>  <p>LN1164A 2pcs.</p> <table border="1" data-bbox="412 847 713 901"> <tr><th>a</th><th>b</th><th>c</th><th>r</th></tr> <tr><td>3.2</td><td>1.6</td><td>25</td><td>90</td></tr> </table>	a	b	c	r	3.2	1.6	25	90	<h3>FN-1167MA</h3> <p>Superseded by FN-1167</p>  <p>LN1167MA 2pcs.</p> <table border="1" data-bbox="1089 847 1388 901"> <tr><th>a</th><th>b</th><th>c</th><th>r</th></tr> <tr><td>3.2</td><td>1.6</td><td>35</td><td>101.4</td></tr> </table>	a	b	c	r	3.2	1.6	35	101.4
a	b	c	r														
3.2	1.6	25	90														
a	b	c	r														
3.2	1.6	35	101.4														
<h3>FN-1165</h3>  <p>LN1165(Front) 4pcs.</p> <table border="1" data-bbox="412 1174 713 1227"> <tr><th>a</th><th>b</th><th>c</th><th>r</th></tr> <tr><td>3.2</td><td>1.6</td><td>35</td><td>101.6</td></tr> </table>	a	b	c	r	3.2	1.6	35	101.6	<h3>FN-1168</h3>  <p>LN1168(Front) 4pcs.</p> <table border="1" data-bbox="1089 1174 1388 1227"> <tr><th>a</th><th>b</th><th>c</th><th>r</th></tr> <tr><td>4.5</td><td>2.3</td><td>50</td><td>130</td></tr> </table>	a	b	c	r	4.5	2.3	50	130
a	b	c	r														
3.2	1.6	35	101.6														
a	b	c	r														
4.5	2.3	50	130														
<h3>FN-1166</h3>  <p>LN1166(Rear) 4pcs.</p> <table border="1" data-bbox="412 1490 713 1544"> <tr><th>a</th><th>b</th><th>c</th><th>r</th></tr> <tr><td>4.5</td><td>2</td><td>50</td><td>90</td></tr> </table>	a	b	c	r	4.5	2	50	90	<h3>FN-1169</h3> <p>DISCONTINUED</p>  <p>LN1169(Front) 4pcs.</p> <table border="1" data-bbox="1089 1490 1388 1544"> <tr><th>a</th><th>b</th><th>c</th><th>r</th></tr> <tr><td>4.5</td><td>2.3</td><td>50</td><td>130</td></tr> </table>	a	b	c	r	4.5	2.3	50	130
a	b	c	r														
4.5	2	50	90														
a	b	c	r														
4.5	2.3	50	130														
<h3>FN-1167</h3>  <p>LN1167 (Rear) 2pcs.</p> <table border="1" data-bbox="412 1807 713 1861"> <tr><th>a</th><th>b</th><th>c</th><th>r</th></tr> <tr><td>3.2</td><td>1.6</td><td>35</td><td>101.6</td></tr> </table>	a	b	c	r	3.2	1.6	35	101.6	<h3>FN-1170</h3>  <p>LN1170 (Rear) 2pcs.</p> <table border="1" data-bbox="1089 1807 1388 1861"> <tr><th>a</th><th>b</th><th>c</th><th>r</th></tr> <tr><td>3.2</td><td>2</td><td>40</td><td>114.3</td></tr> </table>	a	b	c	r	3.2	2	40	114.3
a	b	c	r														
3.2	1.6	35	101.6														
a	b	c	r														
3.2	2	40	114.3														
<h3>FN-1167A</h3>  <p>LN1167A 2pcs.</p> <table border="1" data-bbox="412 2124 713 2177"> <tr><th>a</th><th>b</th><th>c</th><th>r</th></tr> <tr><td>3.2</td><td>1.6</td><td>35</td><td>101.6</td></tr> </table>	a	b	c	r	3.2	1.6	35	101.6	<h3>FN-1170A</h3>  <p>LN1170A 2pcs.</p> <table border="1" data-bbox="1089 2124 1388 2177"> <tr><th>a</th><th>b</th><th>c</th><th>r</th></tr> <tr><td>3.2</td><td>2</td><td>40</td><td>114.3</td></tr> </table>	a	b	c	r	3.2	2	40	114.3
a	b	c	r														
3.2	1.6	35	101.6														
a	b	c	r														
3.2	2	40	114.3														

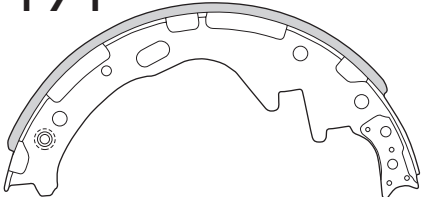
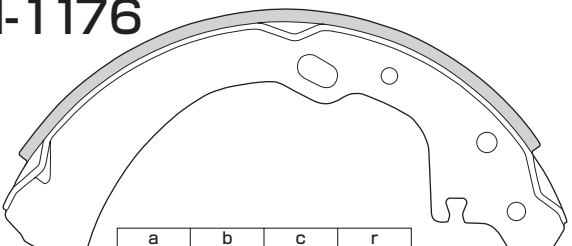
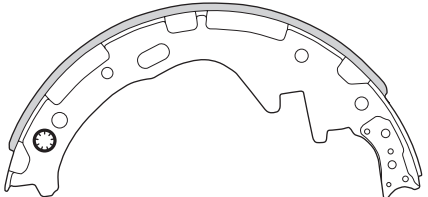
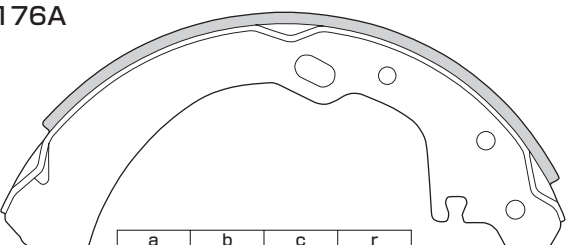
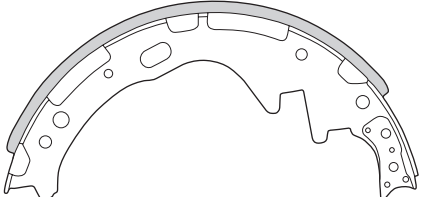
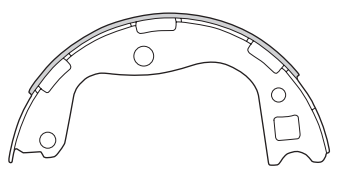
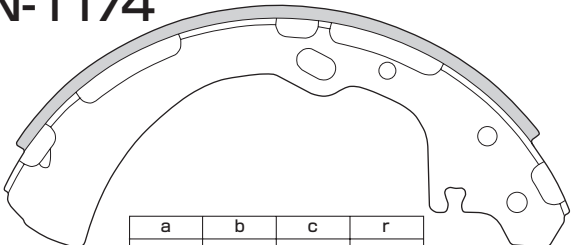
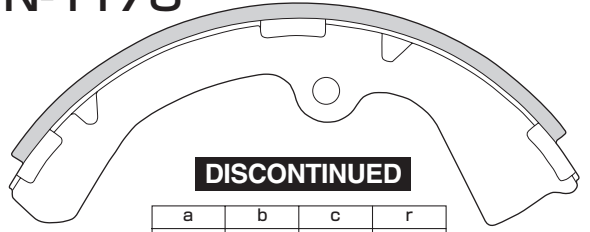
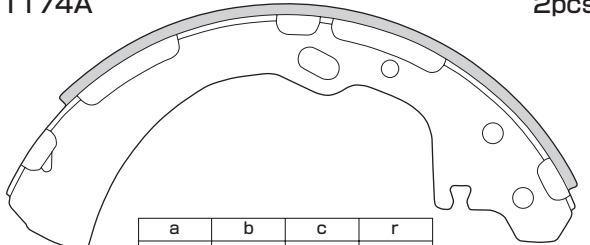
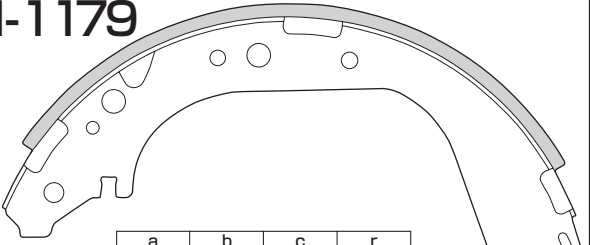
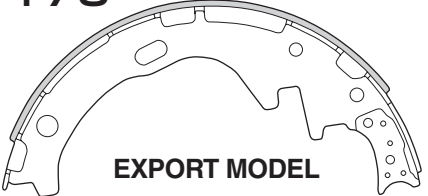
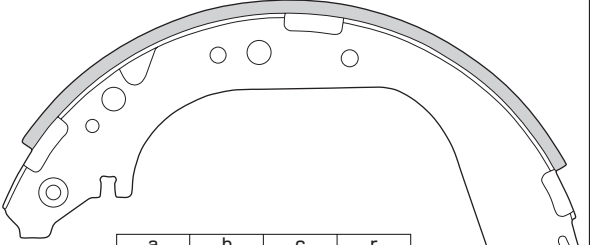
<p>FN-1171</p>  <p>LN1172 (Rear)</p> <table border="1" data-bbox="412 531 713 584"> <tr><th>a</th><th>b</th><th>c</th><th>r</th></tr> <tr><td>4.5</td><td>2.3</td><td>60</td><td>127</td></tr> </table> <p>1 pcs.</p>	a	b	c	r	4.5	2.3	60	127	<p>FN-1176</p>  <p>LN1176 (Rear)</p> <table border="1" data-bbox="1089 531 1390 584"> <tr><th>a</th><th>b</th><th>c</th><th>r</th></tr> <tr><td>4.5</td><td>2.3</td><td>50</td><td>130</td></tr> </table> <p>2 pcs.</p>	a	b	c	r	4.5	2.3	50	130
a	b	c	r														
4.5	2.3	60	127														
a	b	c	r														
4.5	2.3	50	130														
 <p>LN1173</p> <table border="1" data-bbox="412 847 713 901"> <tr><th>a</th><th>b</th><th>c</th><th>r</th></tr> <tr><td>4.5</td><td>2.3</td><td>60</td><td>127</td></tr> </table> <p>1 pc.</p>	a	b	c	r	4.5	2.3	60	127	<p>LN1176A</p>  <p>LN1176A</p> <table border="1" data-bbox="1089 847 1390 901"> <tr><th>a</th><th>b</th><th>c</th><th>r</th></tr> <tr><td>4.5</td><td>2.3</td><td>50</td><td>130</td></tr> </table> <p>2 pcs.</p>	a	b	c	r	4.5	2.3	50	130
a	b	c	r														
4.5	2.3	60	127														
a	b	c	r														
4.5	2.3	50	130														
 <p>LN1171</p> <table border="1" data-bbox="412 1164 713 1218"> <tr><th>a</th><th>b</th><th>c</th><th>r</th></tr> <tr><td>4.5</td><td>2.3</td><td>60</td><td>127</td></tr> </table> <p>2 pc.</p>	a	b	c	r	4.5	2.3	60	127	<p>FN-1177</p>  <p>LN1177(Parking)</p> <table border="1" data-bbox="1089 1169 1390 1222"> <tr><th>a</th><th>b</th><th>c</th><th>r</th></tr> <tr><td>6</td><td>2</td><td>35</td><td>86</td></tr> </table> <p>4 pcs.</p>	a	b	c	r	6	2	35	86
a	b	c	r														
4.5	2.3	60	127														
a	b	c	r														
6	2	35	86														
<p>FN-1174</p>  <p>LN1174 (Rear)</p> <table border="1" data-bbox="412 1485 713 1539"> <tr><th>a</th><th>b</th><th>c</th><th>r</th></tr> <tr><td>4.5</td><td>2.3</td><td>50</td><td>130</td></tr> </table> <p>2 pcs.</p>	a	b	c	r	4.5	2.3	50	130	<p>FN-1178</p>  <p>DISCONTINUED</p> <p>LN1178(Front)</p> <table border="1" data-bbox="1089 1485 1390 1539"> <tr><th>a</th><th>b</th><th>c</th><th>r</th></tr> <tr><td>4.5</td><td>2</td><td>59</td><td>130</td></tr> </table> <p>4 pcs.</p>	a	b	c	r	4.5	2	59	130
a	b	c	r														
4.5	2.3	50	130														
a	b	c	r														
4.5	2	59	130														
<p>LN1174A</p>  <p>LN1174A</p> <table border="1" data-bbox="412 1802 713 1856"> <tr><th>a</th><th>b</th><th>c</th><th>r</th></tr> <tr><td>4.5</td><td>2.3</td><td>50</td><td>130</td></tr> </table> <p>2 pcs.</p>	a	b	c	r	4.5	2.3	50	130	<p>FN-1179</p>  <p>LN2279 (Rear)</p> <table border="1" data-bbox="1089 1802 1390 1856"> <tr><th>a</th><th>b</th><th>c</th><th>r</th></tr> <tr><td>4.5</td><td>2.3</td><td>60</td><td>147.5</td></tr> </table> <p>2 pcs.</p>	a	b	c	r	4.5	2.3	60	147.5
a	b	c	r														
4.5	2.3	50	130														
a	b	c	r														
4.5	2.3	60	147.5														
<p>FN-1175</p>  <p>EXPORT MODEL</p> <p>LN1175(Rear)</p> <table border="1" data-bbox="412 2131 713 2185"> <tr><th>a</th><th>b</th><th>c</th><th>r</th></tr> <tr><td>4.5</td><td>2.3</td><td>45</td><td>127</td></tr> </table> <p>4 pcs.</p>	a	b	c	r	4.5	2.3	45	127	 <p>LN1179</p> <table border="1" data-bbox="1089 2131 1390 2185"> <tr><th>a</th><th>b</th><th>c</th><th>r</th></tr> <tr><td>4.5</td><td>2.3</td><td>60</td><td>147.5</td></tr> </table> <p>2 pcs.</p>	a	b	c	r	4.5	2.3	60	147.5
a	b	c	r														
4.5	2.3	45	127														
a	b	c	r														
4.5	2.3	60	147.5														

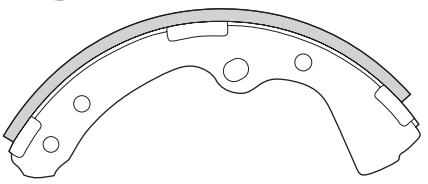
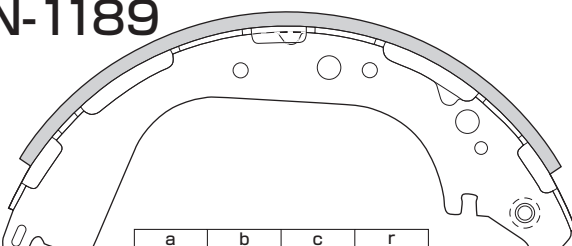
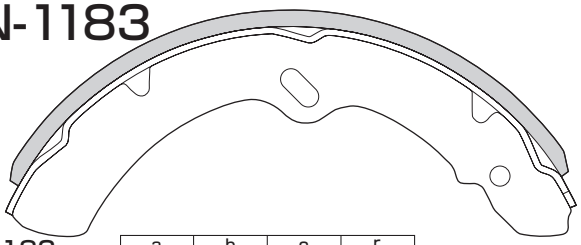
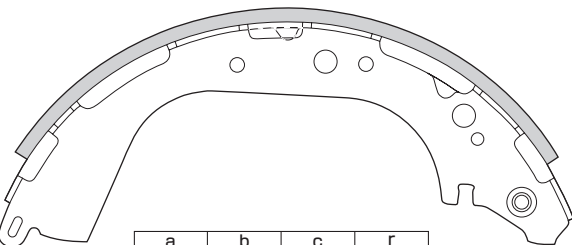
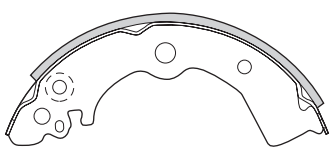
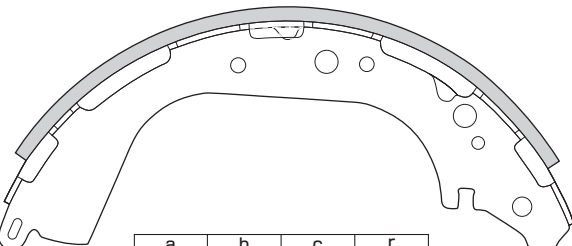
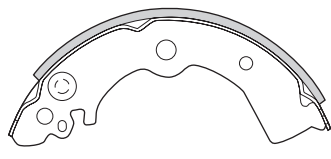
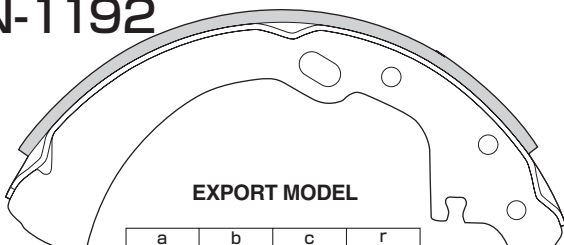
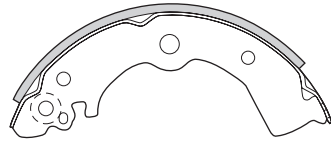
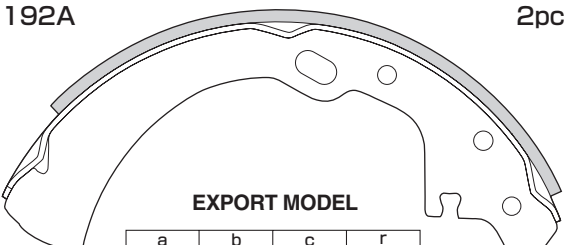
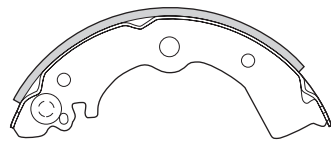
<h3>FN-1182</h3>  <p>LN1182(Front)</p> <table border="1"> <thead> <tr><th>a</th><th>b</th><th>c</th><th>r</th></tr> </thead> <tbody> <tr><td>4</td><td>2</td><td>49</td><td>120.65</td></tr> </tbody> </table> <p>4pcs.</p>	a	b	c	r	4	2	49	120.65	<h3>FN-1189</h3>  <p>LN1189 (Rear)</p> <table border="1"> <thead> <tr><th>a</th><th>b</th><th>c</th><th>r</th></tr> </thead> <tbody> <tr><td>4.5</td><td>2.6</td><td>50</td><td>147.5</td></tr> </tbody> </table> <p>1pc.</p>	a	b	c	r	4.5	2.6	50	147.5
a	b	c	r														
4	2	49	120.65														
a	b	c	r														
4.5	2.6	50	147.5														
<h3>FN-1183</h3>  <p>LN1183 (Front & Rear)</p> <table border="1"> <thead> <tr><th>a</th><th>b</th><th>c</th><th>r</th></tr> </thead> <tbody> <tr><td>6</td><td>3.2</td><td>75</td><td>160</td></tr> </tbody> </table> <p>4pcs.</p>	a	b	c	r	6	3.2	75	160	 <p>LN1190</p> <table border="1"> <thead> <tr><th>a</th><th>b</th><th>c</th><th>r</th></tr> </thead> <tbody> <tr><td>4.5</td><td>2.6</td><td>50</td><td>147.5</td></tr> </tbody> </table> <p>1pc.</p>	a	b	c	r	4.5	2.6	50	147.5
a	b	c	r														
6	3.2	75	160														
a	b	c	r														
4.5	2.6	50	147.5														
<h3>FN-1185</h3>  <p>LN1185 (Rear)</p> <table border="1"> <thead> <tr><th>a</th><th>b</th><th>c</th><th>r</th></tr> </thead> <tbody> <tr><td>3.2</td><td>1.6</td><td>30</td><td>90</td></tr> </tbody> </table> <p>1pc.</p>	a	b	c	r	3.2	1.6	30	90	 <p>LN1191</p> <table border="1"> <thead> <tr><th>a</th><th>b</th><th>c</th><th>r</th></tr> </thead> <tbody> <tr><td>4.5</td><td>2.6</td><td>50</td><td>147.5</td></tr> </tbody> </table> <p>2pcs.</p>	a	b	c	r	4.5	2.6	50	147.5
a	b	c	r														
3.2	1.6	30	90														
a	b	c	r														
4.5	2.6	50	147.5														
 <p>LN1186</p> <table border="1"> <thead> <tr><th>a</th><th>b</th><th>c</th><th>r</th></tr> </thead> <tbody> <tr><td>3.2</td><td>1.6</td><td>30</td><td>90</td></tr> </tbody> </table> <p>1pc.</p>	a	b	c	r	3.2	1.6	30	90	<h3>FN-1192</h3>  <p>EXPORT MODEL</p> <p>LN1192 (Rear)</p> <table border="1"> <thead> <tr><th>a</th><th>b</th><th>c</th><th>r</th></tr> </thead> <tbody> <tr><td>4.5</td><td>2.3</td><td>40</td><td>130</td></tr> </tbody> </table> <p>2pcs.</p>	a	b	c	r	4.5	2.3	40	130
a	b	c	r														
3.2	1.6	30	90														
a	b	c	r														
4.5	2.3	40	130														
 <p>LN1187</p> <table border="1"> <thead> <tr><th>a</th><th>b</th><th>c</th><th>r</th></tr> </thead> <tbody> <tr><td>3.2</td><td>1.6</td><td>30</td><td>90</td></tr> </tbody> </table> <p>1pc.</p>	a	b	c	r	3.2	1.6	30	90	<h3>LN1192A</h3>  <p>EXPORT MODEL</p> <table border="1"> <thead> <tr><th>a</th><th>b</th><th>c</th><th>r</th></tr> </thead> <tbody> <tr><td>4.5</td><td>2.3</td><td>40</td><td>130</td></tr> </tbody> </table> <p>2pcs.</p>	a	b	c	r	4.5	2.3	40	130
a	b	c	r														
3.2	1.6	30	90														
a	b	c	r														
4.5	2.3	40	130														
 <p>L1188</p> <table border="1"> <thead> <tr><th>a</th><th>b</th><th>c</th><th>r</th></tr> </thead> <tbody> <tr><td>3.2</td><td>1.6</td><td>30</td><td>90</td></tr> </tbody> </table> <p>1pc.</p>	a	b	c	r	3.2	1.6	30	90									
a	b	c	r														
3.2	1.6	30	90														

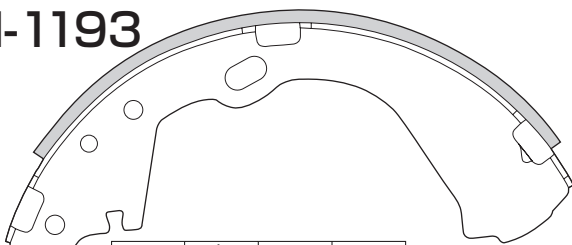
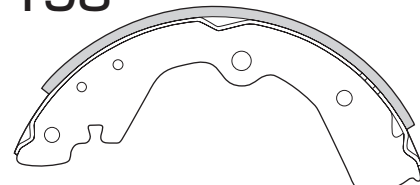
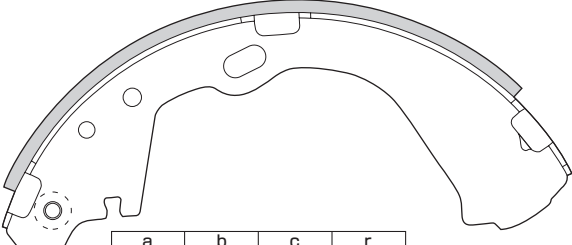
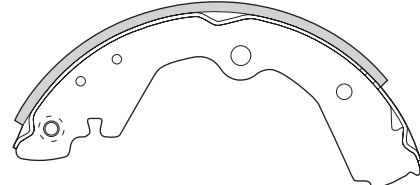
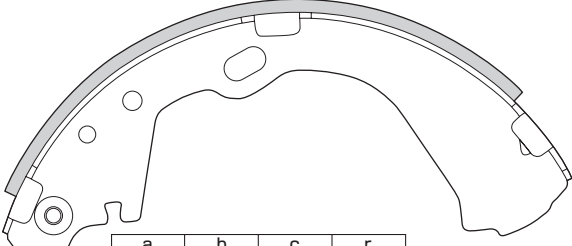
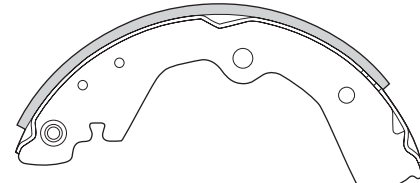
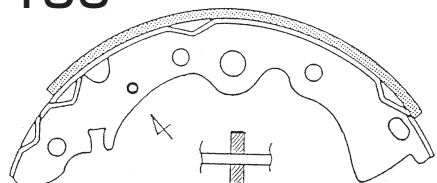
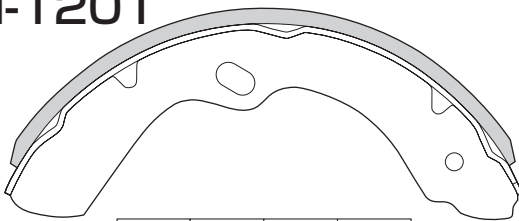
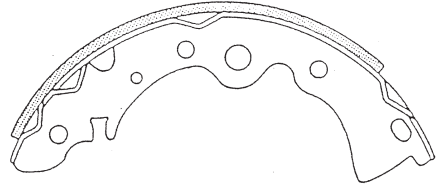
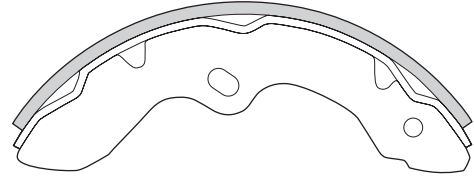
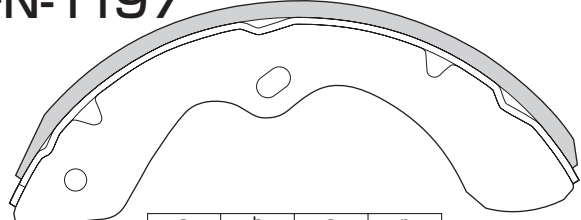
<p>FN-1193</p>  <p>LN1193 (Rear) 2pcs.</p> <table border="1" data-bbox="412 523 707 584"> <thead> <tr> <th>a</th> <th>b</th> <th>c</th> <th>r</th> </tr> </thead> <tbody> <tr> <td>4</td> <td>2.3</td> <td>40</td> <td>130</td> </tr> </tbody> </table>	a	b	c	r	4	2.3	40	130	<p>FN-1198</p>  <p>LN1198 (Rear) 2pcs.</p> <table border="1" data-bbox="1084 523 1379 584"> <thead> <tr> <th>a</th> <th>b</th> <th>c</th> <th>r</th> </tr> </thead> <tbody> <tr> <td>3.2</td> <td>2.0</td> <td>40</td> <td>114.3</td> </tr> </tbody> </table>	a	b	c	r	3.2	2.0	40	114.3
a	b	c	r														
4	2.3	40	130														
a	b	c	r														
3.2	2.0	40	114.3														
<p>LN1194 1pc.</p>  <table border="1" data-bbox="412 840 707 901"> <thead> <tr> <th>a</th> <th>b</th> <th>c</th> <th>r</th> </tr> </thead> <tbody> <tr> <td>4</td> <td>2.3</td> <td>40</td> <td>130</td> </tr> </tbody> </table>	a	b	c	r	4	2.3	40	130	<p>LN1199 1pc.</p>  <table border="1" data-bbox="1084 840 1379 901"> <thead> <tr> <th>a</th> <th>b</th> <th>c</th> <th>r</th> </tr> </thead> <tbody> <tr> <td>3.2</td> <td>2.0</td> <td>40</td> <td>114.3</td> </tr> </tbody> </table>	a	b	c	r	3.2	2.0	40	114.3
a	b	c	r														
4	2.3	40	130														
a	b	c	r														
3.2	2.0	40	114.3														
<p>LN1195 1pc.</p>  <table border="1" data-bbox="412 1157 707 1218"> <thead> <tr> <th>a</th> <th>b</th> <th>c</th> <th>r</th> </tr> </thead> <tbody> <tr> <td>4</td> <td>2.3</td> <td>40</td> <td>130</td> </tr> </tbody> </table>	a	b	c	r	4	2.3	40	130	<p>LN1200 1pc.</p>  <table border="1" data-bbox="1084 1157 1379 1218"> <thead> <tr> <th>a</th> <th>b</th> <th>c</th> <th>r</th> </tr> </thead> <tbody> <tr> <td>3.2</td> <td>2.0</td> <td>40</td> <td>114.3</td> </tr> </tbody> </table>	a	b	c	r	3.2	2.0	40	114.3
a	b	c	r														
4	2.3	40	130														
a	b	c	r														
3.2	2.0	40	114.3														
<p>FN-1196</p>  <p>LN1196 (Rear) 2pcs.</p> <table border="1" data-bbox="412 1485 707 1546"> <thead> <tr> <th>a</th> <th>b</th> <th>c</th> <th>r</th> </tr> </thead> <tbody> <tr> <td>3.2</td> <td>1.6</td> <td>35</td> <td>101.6</td> </tr> </tbody> </table>	a	b	c	r	3.2	1.6	35	101.6	<p>FN-1201</p>  <p>LN1201 (Front & Rear) 4pcs.</p> <table border="1" data-bbox="1084 1485 1379 1546"> <thead> <tr> <th>a</th> <th>b</th> <th>c</th> <th>r</th> </tr> </thead> <tbody> <tr> <td>6</td> <td>3.2</td> <td>75</td> <td>160</td> </tr> </tbody> </table>	a	b	c	r	6	3.2	75	160
a	b	c	r														
3.2	1.6	35	101.6														
a	b	c	r														
6	3.2	75	160														
<p>LN1167A 2pcs.</p>  <table border="1" data-bbox="412 1802 707 1863"> <thead> <tr> <th>a</th> <th>b</th> <th>c</th> <th>r</th> </tr> </thead> <tbody> <tr> <td>3.2</td> <td>1.6</td> <td>35</td> <td>101.6</td> </tr> </tbody> </table>	a	b	c	r	3.2	1.6	35	101.6	<p>FN-1202</p>  <p>LN1202(R) 4pcs.</p> <table border="1" data-bbox="1084 1802 1379 1863"> <thead> <tr> <th>a</th> <th>b</th> <th>c</th> <th>r</th> </tr> </thead> <tbody> <tr> <td>6</td> <td>3.2</td> <td>75</td> <td>114.3</td> </tr> </tbody> </table>	a	b	c	r	6	3.2	75	114.3
a	b	c	r														
3.2	1.6	35	101.6														
a	b	c	r														
6	3.2	75	114.3														
<p>FN-1197</p>  <p>LN1197(Front) 4pcs.</p> <table border="1" data-bbox="412 2131 707 2192"> <thead> <tr> <th>a</th> <th>b</th> <th>c</th> <th>r</th> </tr> </thead> <tbody> <tr> <td>6</td> <td>3.2</td> <td>75</td> <td>150</td> </tr> </tbody> </table>	a	b	c	r	6	3.2	75	150									
a	b	c	r														
6	3.2	75	150														

FN-1204

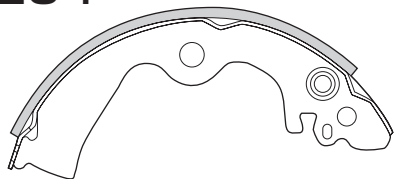

LN1204

(Rear)

a	b	c	r
3.2	1.6	25	90

1pc.

FN-1208

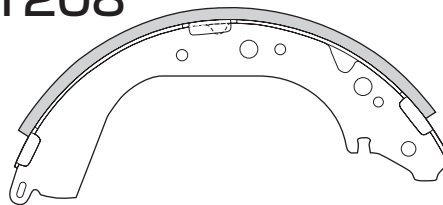

LN2279

(Rear)

a	b	c	r
4.5	2.3	60	147.5

2pcs.

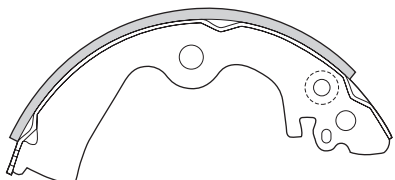

LN1205

a	b	c	r
3.2	1.6	25	90

1pc.

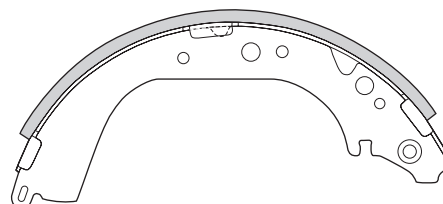

LN1208

a	b	c	r
4.5	2.3	60	147.5

1pc.

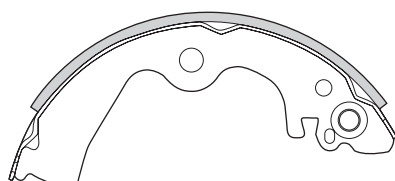

LN1206

a	b	c	r
3.2	1.6	25	90

1pc.

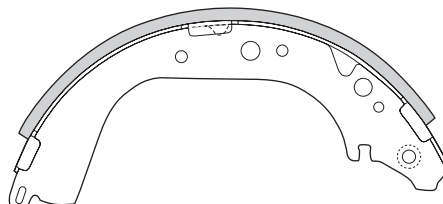

LN1209

a	b	c	r
4.5	2.3	60	147.5

1pc.

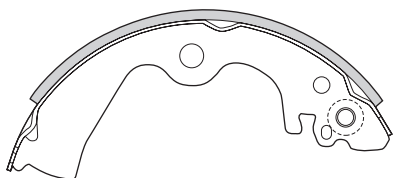

LN1207

a	b	c	r
3.2	1.6	25	90

1pc.

FN-1210

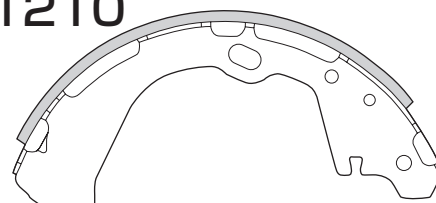

LN1210

(Rear)

a	b	c	r
4	2.3	50	130

2pcs.

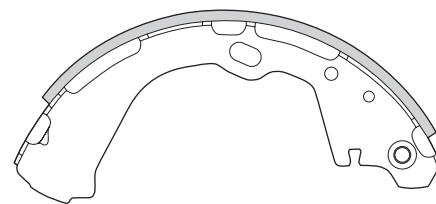

LN1211

a	b	c	r
4	2.3	50	130

1pc.

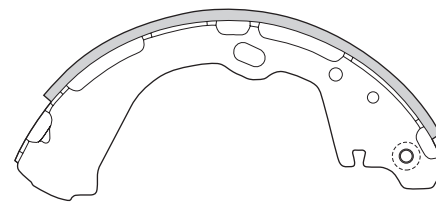

LN1212

a	b	c	r
4	2.3	50	130

1pc.

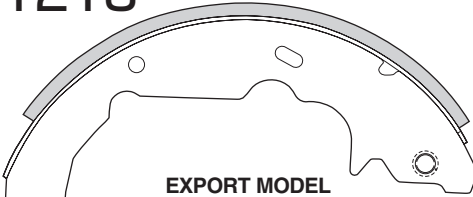
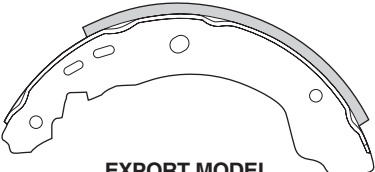
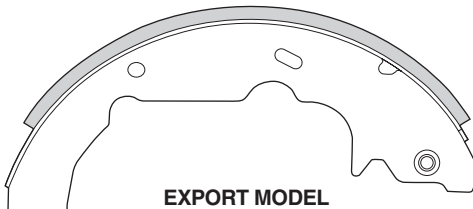
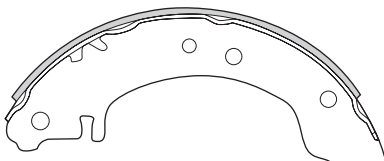
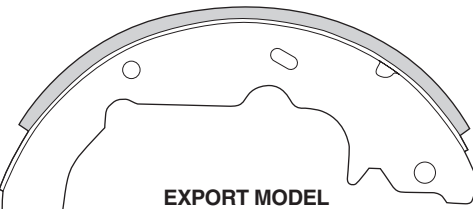
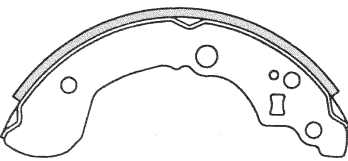
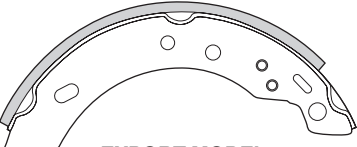
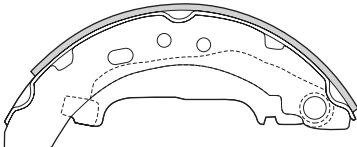
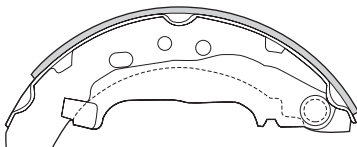
<p>FN-1213</p>  <p>EXPORT MODEL</p> <table border="1" data-bbox="421 531 716 584"> <thead> <tr> <th>a</th> <th>b</th> <th>c</th> <th>r</th> </tr> </thead> <tbody> <tr> <td>4</td> <td>2</td> <td>55</td> <td>125</td> </tr> </tbody> </table> <p>LN1213 (Rear) 1pc.</p>	a	b	c	r	4	2	55	125	<p>FN-1221</p>  <p>EXPORT MODEL</p> <table border="1" data-bbox="1084 531 1379 584"> <thead> <tr> <th>a</th> <th>b</th> <th>c</th> <th>r</th> </tr> </thead> <tbody> <tr> <td>4</td> <td>2</td> <td>37</td> <td>101.6</td> </tr> </tbody> </table> <p>LN1221 (Rear) 2pcs.</p>	a	b	c	r	4	2	37	101.6
a	b	c	r														
4	2	55	125														
a	b	c	r														
4	2	37	101.6														
 <p>EXPORT MODEL</p> <table border="1" data-bbox="421 847 716 901"> <thead> <tr> <th>a</th> <th>b</th> <th>c</th> <th>r</th> </tr> </thead> <tbody> <tr> <td>4</td> <td>2</td> <td>55</td> <td>125</td> </tr> </tbody> </table> <p>LN1214 1pc.</p>	a	b	c	r	4	2	55	125	 <p>EXPORT MODEL</p> <table border="1" data-bbox="1084 847 1379 901"> <thead> <tr> <th>a</th> <th>b</th> <th>c</th> <th>r</th> </tr> </thead> <tbody> <tr> <td>4</td> <td>2</td> <td>37</td> <td>101.6</td> </tr> </tbody> </table> <p>LN1222 2pcs.</p>	a	b	c	r	4	2	37	101.6
a	b	c	r														
4	2	55	125														
a	b	c	r														
4	2	37	101.6														
 <p>EXPORT MODEL</p> <table border="1" data-bbox="421 1164 716 1218"> <thead> <tr> <th>a</th> <th>b</th> <th>c</th> <th>r</th> </tr> </thead> <tbody> <tr> <td>4</td> <td>2</td> <td>55</td> <td>125</td> </tr> </tbody> </table> <p>LN1215 2pcs.</p>	a	b	c	r	4	2	55	125	<p>FN-1223</p>  <p>EXPORT MODEL</p> <table border="1" data-bbox="1084 1169 1379 1222"> <thead> <tr> <th>a</th> <th>b</th> <th>c</th> <th>r</th> </tr> </thead> <tbody> <tr> <td>3.2</td> <td>2</td> <td>35</td> <td>101.6</td> </tr> </tbody> </table> <p>LN1223 (Rear) 4pcs.</p>	a	b	c	r	3.2	2	35	101.6
a	b	c	r														
4	2	55	125														
a	b	c	r														
3.2	2	35	101.6														
<p>FN-1217</p>  <p>EXPORT MODEL</p> <table border="1" data-bbox="421 1485 716 1539"> <thead> <tr> <th>a</th> <th>b</th> <th>c</th> <th>r</th> </tr> </thead> <tbody> <tr> <td>3.2</td> <td>1.6</td> <td>25</td> <td>90</td> </tr> </tbody> </table> <p>LN1217 (Rear) 2pcs.</p>	a	b	c	r	3.2	1.6	25	90									
a	b	c	r														
3.2	1.6	25	90														
 <p>EXPORT MODEL</p> <table border="1" data-bbox="421 1802 716 1856"> <thead> <tr> <th>a</th> <th>b</th> <th>c</th> <th>r</th> </tr> </thead> <tbody> <tr> <td>3.2</td> <td>1.6</td> <td>25</td> <td>90</td> </tr> </tbody> </table> <p>LN1219 1pc.</p>	a	b	c	r	3.2	1.6	25	90									
a	b	c	r														
3.2	1.6	25	90														
 <p>EXPORT MODEL</p> <table border="1" data-bbox="421 2119 716 2172"> <thead> <tr> <th>a</th> <th>b</th> <th>c</th> <th>r</th> </tr> </thead> <tbody> <tr> <td>3.2</td> <td>1.6</td> <td>25</td> <td>90</td> </tr> </tbody> </table> <p>LN1220 1pc.</p>	a	b	c	r	3.2	1.6	25	90									
a	b	c	r														
3.2	1.6	25	90														

FN-1225

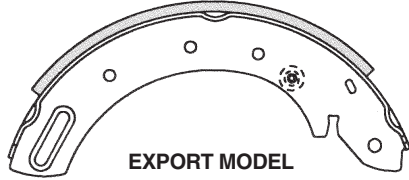

a	b	c	r
3.2	2.3	55	127

LN1225
(Rear)

1pc.

FN-1230

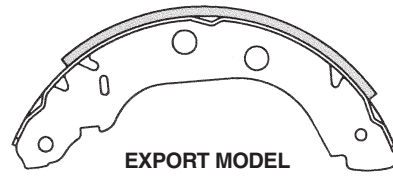

a	b	c	r
4	2	40	114.3

LN1230
(Rear)

2pcs.



a	b	c	r
3.2	2.3	55	127

LN1226

1pc.



a	b	c	r
4	2	40	114.3

LN1231

1pc.



a	b	c	r
3.2	2.3	55	127

LN1228

1pc.

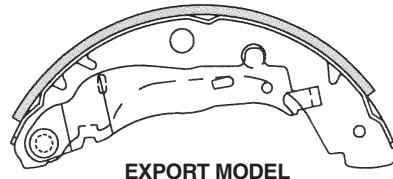

a	b	c	r
4	2	40	114.3

LN1232









1pc.

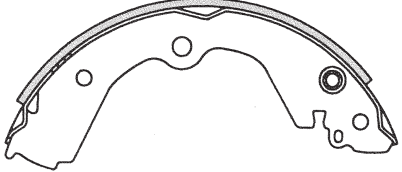
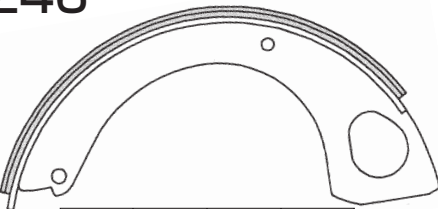
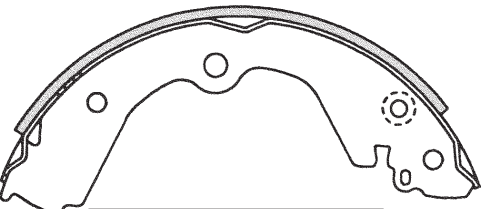

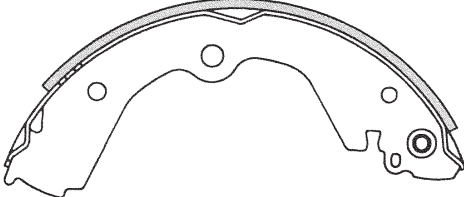
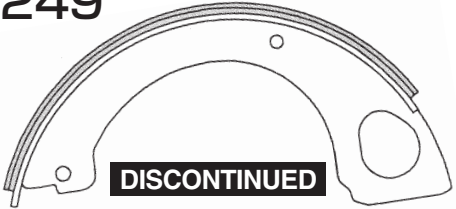
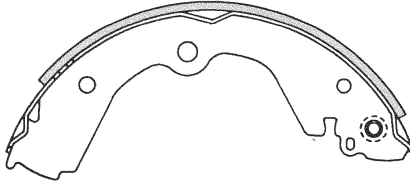

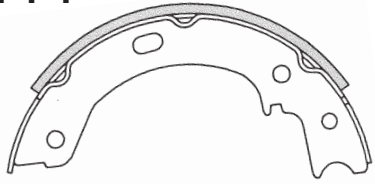
a	b	c	r
3.2	2.3	55	127

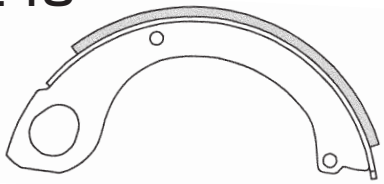
LN1229

1pc.

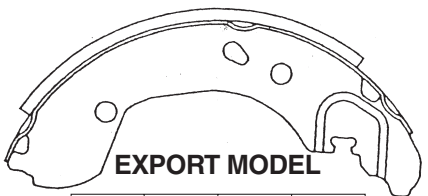
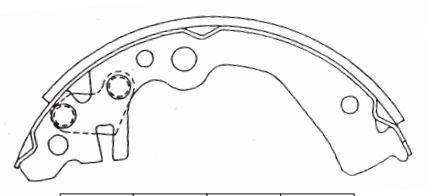
<p>FN-1240</p>  <p>LN1240 (Rear)</p> <table border="1" data-bbox="421 535 716 584"> <thead> <tr> <th>a</th> <th>b</th> <th>c</th> <th>r</th> </tr> </thead> <tbody> <tr> <td>3.2</td> <td>2</td> <td>40</td> <td>114.3</td> </tr> </tbody> </table> <p>1 pc.</p>	a	b	c	r	3.2	2	40	114.3	<p>FN1246</p>  <p>LN1246 (Parking)</p> <table border="1" data-bbox="1084 535 1379 584"> <thead> <tr> <th>a</th> <th>b</th> <th>c</th> <th>r</th> </tr> </thead> <tbody> <tr> <td>6</td> <td>3.2</td> <td>60</td> <td>127</td> </tr> </tbody> </table> <p>2 pcs.</p>	a	b	c	r	6	3.2	60	127
a	b	c	r														
3.2	2	40	114.3														
a	b	c	r														
6	3.2	60	127														
 <p>LN1241</p> <table border="1" data-bbox="421 852 716 901"> <thead> <tr> <th>a</th> <th>b</th> <th>c</th> <th>r</th> </tr> </thead> <tbody> <tr> <td>3.2</td> <td>2</td> <td>40</td> <td>114.3</td> </tr> </tbody> </table> <p>1 pc.</p>	a	b	c	r	3.2	2	40	114.3	<p>FN-1247</p>  <p>EXPORT MODEL</p> <p>LN1247(Rear)</p> <table border="1" data-bbox="1084 852 1379 901"> <thead> <tr> <th>a</th> <th>b</th> <th>c</th> <th>r</th> </tr> </thead> <tbody> <tr> <td>3.2</td> <td>2</td> <td>35</td> <td>101.6</td> </tr> </tbody> </table> <p>4 pcs.</p>	a	b	c	r	3.2	2	35	101.6
a	b	c	r														
3.2	2	40	114.3														
a	b	c	r														
3.2	2	35	101.6														
 <p>LN1242</p> <table border="1" data-bbox="421 1169 716 1218"> <thead> <tr> <th>a</th> <th>b</th> <th>c</th> <th>r</th> </tr> </thead> <tbody> <tr> <td>3.2</td> <td>2</td> <td>40</td> <td>114.3</td> </tr> </tbody> </table> <p>1 pc.</p>	a	b	c	r	3.2	2	40	114.3	<p>FN-1249</p>  <p>DISCONTINUED</p> <p>LN1249 (Parking)</p> <table border="1" data-bbox="1084 1169 1379 1218"> <thead> <tr> <th>a</th> <th>b</th> <th>c</th> <th>r</th> </tr> </thead> <tbody> <tr> <td>6</td> <td>3.2</td> <td>6.0</td> <td>127</td> </tr> </tbody> </table> <p>2 pcs.</p>	a	b	c	r	6	3.2	6.0	127
a	b	c	r														
3.2	2	40	114.3														
a	b	c	r														
6	3.2	6.0	127														
 <p>LN1243</p> <table border="1" data-bbox="421 1485 716 1534"> <thead> <tr> <th>a</th> <th>b</th> <th>c</th> <th>r</th> </tr> </thead> <tbody> <tr> <td>3.2</td> <td>2</td> <td>40</td> <td>114.3</td> </tr> </tbody> </table> <p>1 pc.</p>	a	b	c	r	3.2	2	40	114.3	<p>FN-1251</p>  <p>EXPORT MODEL</p> <p>LN1251 (Rear)</p> <table border="1" data-bbox="1084 1485 1379 1534"> <thead> <tr> <th>a</th> <th>b</th> <th>c</th> <th>r</th> </tr> </thead> <tbody> <tr> <td>3.5</td> <td>1.6</td> <td>25</td> <td>90</td> </tr> </tbody> </table> <p>2 pcs.</p>	a	b	c	r	3.5	1.6	25	90
a	b	c	r														
3.2	2	40	114.3														
a	b	c	r														
3.5	1.6	25	90														
<p>FN-1244</p>  <p>LN1244 (Parking)</p> <table border="1" data-bbox="421 1814 716 1863"> <thead> <tr> <th>a</th> <th>b</th> <th>c</th> <th>r</th> </tr> </thead> <tbody> <tr> <td>4.5</td> <td>2.3</td> <td>44.5</td> <td>101.6</td> </tr> </tbody> </table> <p>2 pcs.</p>	a	b	c	r	4.5	2.3	44.5	101.6	<p>EXPORT MODEL</p>  <p>LN1253</p> <table border="1" data-bbox="1084 1814 1379 1863"> <thead> <tr> <th>a</th> <th>b</th> <th>c</th> <th>r</th> </tr> </thead> <tbody> <tr> <td>3.5</td> <td>1.6</td> <td>25</td> <td>90</td> </tr> </tbody> </table> <p>1 pcs.</p>	a	b	c	r	3.5	1.6	25	90
a	b	c	r														
4.5	2.3	44.5	101.6														
a	b	c	r														
3.5	1.6	25	90														
<p>FN-1245</p>  <p>LN1245 (Parking)</p> <table border="1" data-bbox="421 2131 716 2180"> <thead> <tr> <th>a</th> <th>b</th> <th>c</th> <th>r</th> </tr> </thead> <tbody> <tr> <td>4.5</td> <td>2.6</td> <td>34.5</td> <td>101.6</td> </tr> </tbody> </table> <p>2 pcs.</p>	a	b	c	r	4.5	2.6	34.5	101.6	<p>EXPORT MODEL</p>  <p>LN1254</p> <table border="1" data-bbox="1084 2131 1379 2180"> <thead> <tr> <th>a</th> <th>b</th> <th>c</th> <th>r</th> </tr> </thead> <tbody> <tr> <td>3.5</td> <td>1.6</td> <td>25</td> <td>90</td> </tr> </tbody> </table> <p>1 pcs.</p>	a	b	c	r	3.5	1.6	25	90
a	b	c	r														
4.5	2.6	34.5	101.6														
a	b	c	r														
3.5	1.6	25	90														

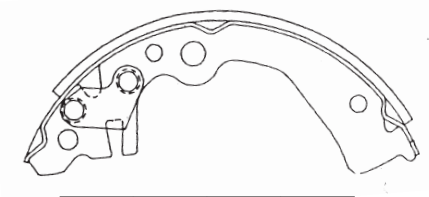
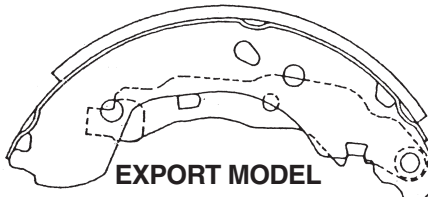
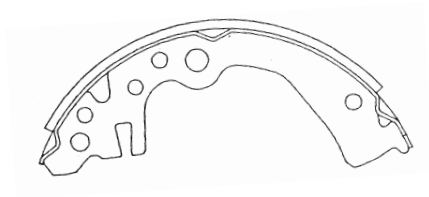
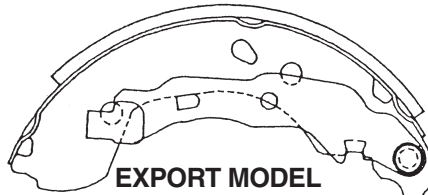
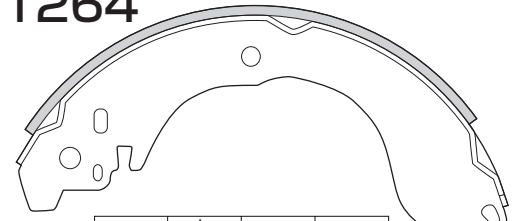
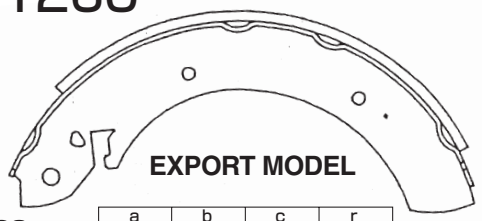
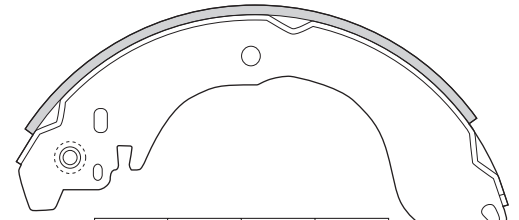
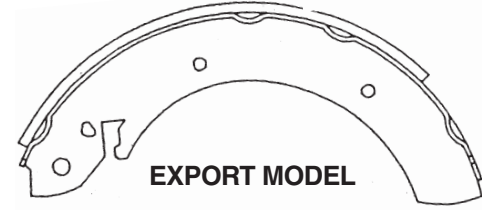
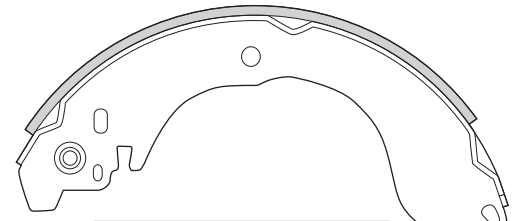
<h3>FN-1255</h3>  <p>EXPORT MODEL</p> <table border="1"> <tr><th>a</th><th>b</th><th>c</th><th>r</th></tr> <tr><td>3.2</td><td>1.6</td><td>35</td><td>101.6</td></tr> </table> <p>LN1255 (Rear) 1pc.</p>	a	b	c	r	3.2	1.6	35	101.6	<h3>FN1261</h3>  <table border="1"> <tr><th>a</th><th>b</th><th>c</th><th>r</th></tr> <tr><td>3.2</td><td>1.6</td><td>25</td><td>90</td></tr> </table> <p>LN1261 (Rear) 1pcs.</p>	a	b	c	r	3.2	1.6	25	90
a	b	c	r														
3.2	1.6	35	101.6														
a	b	c	r														
3.2	1.6	25	90														
 <p>EXPORT MODEL</p> <table border="1"> <tr><th>a</th><th>b</th><th>c</th><th>r</th></tr> <tr><td>3.2</td><td>1.6</td><td>35</td><td>101.6</td></tr> </table> <p>LN1256 1pc.</p>	a	b	c	r	3.2	1.6	35	101.6	 <table border="1"> <tr><th>a</th><th>b</th><th>c</th><th>r</th></tr> <tr><td>3.2</td><td>1.6</td><td>25</td><td>90</td></tr> </table> <p>LN1262 1pcs.</p>	a	b	c	r	3.2	1.6	25	90
a	b	c	r														
3.2	1.6	35	101.6														
a	b	c	r														
3.2	1.6	25	90														
 <p>EXPORT MODEL</p> <table border="1"> <tr><th>a</th><th>b</th><th>c</th><th>r</th></tr> <tr><td>3.2</td><td>1.6</td><td>35</td><td>101.6</td></tr> </table> <p>LN1258 1pc.</p>	a	b	c	r	3.2	1.6	35	101.6	 <table border="1"> <tr><th>a</th><th>b</th><th>c</th><th>r</th></tr> <tr><td>3.2</td><td>1.6</td><td>25</td><td>90</td></tr> </table> <p>LN1263 2pcs.</p>	a	b	c	r	3.2	1.6	25	90
a	b	c	r														
3.2	1.6	35	101.6														
a	b	c	r														
3.2	1.6	25	90														
 <p>EXPORT MODEL</p> <table border="1"> <tr><th>a</th><th>b</th><th>c</th><th>r</th></tr> <tr><td>3.2</td><td>1.6</td><td>35</td><td>101.6</td></tr> </table> <p>LN1259 1pc.</p>	a	b	c	r	3.2	1.6	35	101.6	<h3>FN-1264</h3>  <table border="1"> <tr><th>a</th><th>b</th><th>c</th><th>r</th></tr> <tr><td>3.2</td><td>2</td><td>35</td><td>114.3</td></tr> </table> <p>LN1264 (Rear) 2pcs.</p>	a	b	c	r	3.2	2	35	114.3
a	b	c	r														
3.2	1.6	35	101.6														
a	b	c	r														
3.2	2	35	114.3														
<h3>FN-1260</h3>  <p>EXPORT MODEL</p> <table border="1"> <tr><th>a</th><th>b</th><th>c</th><th>r</th></tr> <tr><td>3.2</td><td>2.3</td><td>55</td><td>127</td></tr> </table> <p>LN1260 (Rear) 2pcs.</p>	a	b	c	r	3.2	2.3	55	127	 <table border="1"> <tr><th>a</th><th>b</th><th>c</th><th>r</th></tr> <tr><td>3.2</td><td>2</td><td>35</td><td>114.3</td></tr> </table> <p>LN1265 1pc.</p>	a	b	c	r	3.2	2	35	114.3
a	b	c	r														
3.2	2.3	55	127														
a	b	c	r														
3.2	2	35	114.3														
 <p>EXPORT MODEL</p> <table border="1"> <tr><th>a</th><th>b</th><th>c</th><th>r</th></tr> <tr><td>3.2</td><td>2.3</td><td>55</td><td>127</td></tr> </table> <p>LN1260A 2pcs.</p>	a	b	c	r	3.2	2.3	55	127	 <table border="1"> <tr><th>a</th><th>b</th><th>c</th><th>r</th></tr> <tr><td>3.2</td><td>2</td><td>35</td><td>114.3</td></tr> </table> <p>LN1264 1pc.</p>	a	b	c	r	3.2	2	35	114.3
a	b	c	r														
3.2	2.3	55	127														
a	b	c	r														
3.2	2	35	114.3														

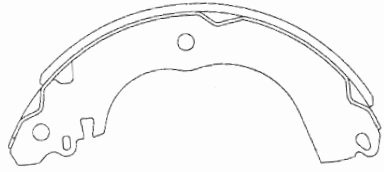
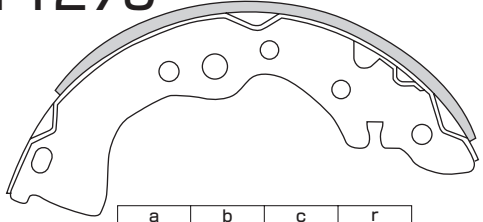
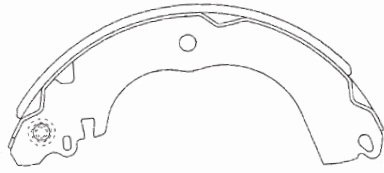
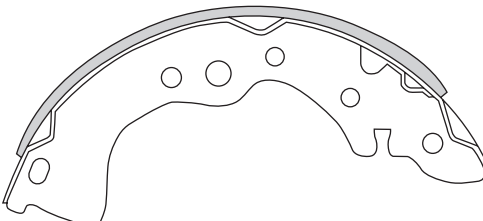
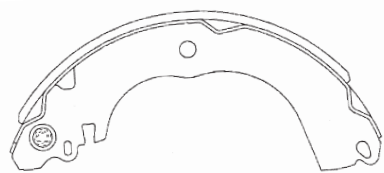
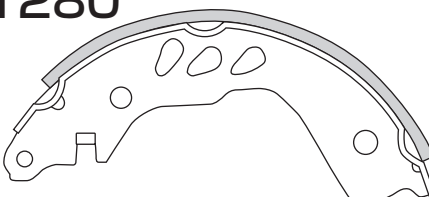
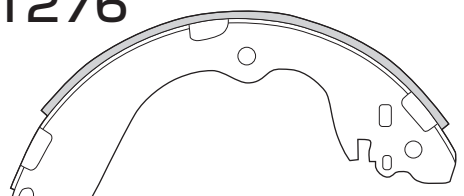
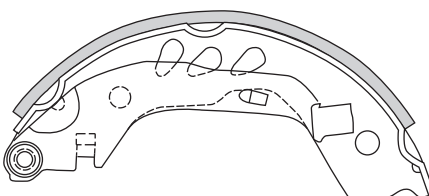
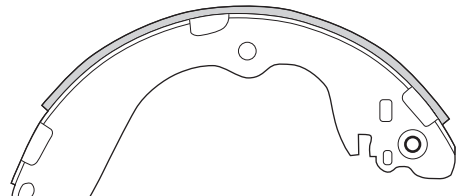
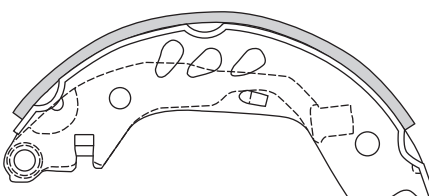
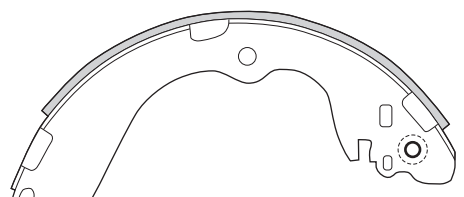
<p>FN-1267</p>  <p>LN1267 (Rear)</p> <table border="1" data-bbox="421 531 716 584"> <tr><th>a</th><th>b</th><th>c</th><th>r</th></tr> <tr><td>3.2</td><td>1.6</td><td>30</td><td>101.6</td></tr> </table> <p>2pc.</p>	a	b	c	r	3.2	1.6	30	101.6	<p>FN-1279</p>  <p>LN1279 (Rear)</p> <table border="1" data-bbox="1093 531 1388 584"> <tr><th>a</th><th>b</th><th>c</th><th>r</th></tr> <tr><td>3.2</td><td>1.6</td><td>34</td><td>102</td></tr> </table> <p>2pcs.</p>	a	b	c	r	3.2	1.6	34	102
a	b	c	r														
3.2	1.6	30	101.6														
a	b	c	r														
3.2	1.6	34	102														
 <p>LN1268</p> <table border="1" data-bbox="421 847 716 901"> <tr><th>a</th><th>b</th><th>c</th><th>r</th></tr> <tr><td>3.2</td><td>1.6</td><td>30</td><td>101.6</td></tr> </table> <p>1pc.</p>	a	b	c	r	3.2	1.6	30	101.6	 <p>LN1279</p> <table border="1" data-bbox="1093 847 1388 901"> <tr><th>a</th><th>b</th><th>c</th><th>r</th></tr> <tr><td>3.2</td><td>1.6</td><td>34</td><td>102</td></tr> </table> <p>2pcs.</p>	a	b	c	r	3.2	1.6	34	102
a	b	c	r														
3.2	1.6	30	101.6														
a	b	c	r														
3.2	1.6	34	102														
 <p>LN1269</p> <table border="1" data-bbox="421 1164 716 1218"> <tr><th>a</th><th>b</th><th>c</th><th>r</th></tr> <tr><td>3.2</td><td>1.6</td><td>30</td><td>101.6</td></tr> </table> <p>1pc.</p>	a	b	c	r	3.2	1.6	30	101.6	<p>FN-1280</p>  <p>LN1280 (Rear)</p> <table border="1" data-bbox="1084 1164 1379 1218"> <tr><th>a</th><th>b</th><th>c</th><th>r</th></tr> <tr><td>3.6</td><td>1.6</td><td>25</td><td>90</td></tr> </table> <p>2pcs.</p>	a	b	c	r	3.6	1.6	25	90
a	b	c	r														
3.2	1.6	30	101.6														
a	b	c	r														
3.6	1.6	25	90														
<p>FN-1276</p>  <p>LN1276 (Rear)</p> <table border="1" data-bbox="421 1485 716 1539"> <tr><th>a</th><th>b</th><th>c</th><th>r</th></tr> <tr><td>3.2</td><td>2</td><td>35</td><td>114.3</td></tr> </table> <p>2pcs.</p>	a	b	c	r	3.2	2	35	114.3	 <p>LN1281</p> <table border="1" data-bbox="1084 1485 1379 1539"> <tr><th>a</th><th>b</th><th>c</th><th>r</th></tr> <tr><td>3.6</td><td>1.6</td><td>25</td><td>90</td></tr> </table> <p>1pcs.</p>	a	b	c	r	3.6	1.6	25	90
a	b	c	r														
3.2	2	35	114.3														
a	b	c	r														
3.6	1.6	25	90														
 <p>LN1277</p> <table border="1" data-bbox="421 1802 716 1856"> <tr><th>a</th><th>b</th><th>c</th><th>r</th></tr> <tr><td>3.2</td><td>2</td><td>35</td><td>114.3</td></tr> </table> <p>1pc.</p>	a	b	c	r	3.2	2	35	114.3	 <p>LN1282</p> <table border="1" data-bbox="1084 1802 1379 1856"> <tr><th>a</th><th>b</th><th>c</th><th>r</th></tr> <tr><td>3.6</td><td>1.6</td><td>25</td><td>90</td></tr> </table> <p>1pcs.</p>	a	b	c	r	3.6	1.6	25	90
a	b	c	r														
3.2	2	35	114.3														
a	b	c	r														
3.6	1.6	25	90														
 <p>LN1278</p> <table border="1" data-bbox="421 2119 716 2172"> <tr><th>a</th><th>b</th><th>c</th><th>r</th></tr> <tr><td>3.2</td><td>2</td><td>35</td><td>114.3</td></tr> </table> <p>1pc.</p>	a	b	c	r	3.2	2	35	114.3									
a	b	c	r														
3.2	2	35	114.3														

FN-1286

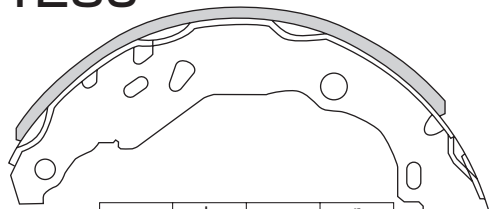

LN1286
(Rear)

a	b	c	r
3	2	37	100.5

2pcs.

FN-1901

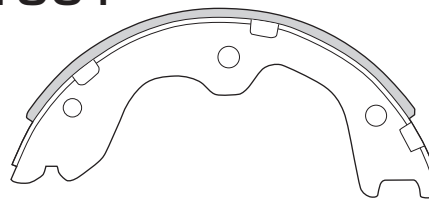

LN1901
(Parking)

a	b	c	r
6	1.6	20	86.5

4pcs.

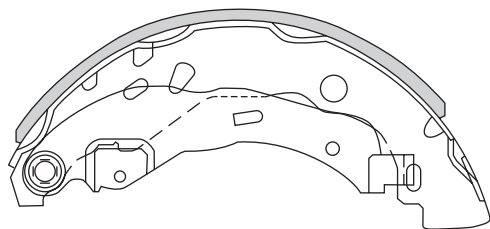

LN1287

a	b	c	r
3	2	37	100.5

2pcs.

FN-1902

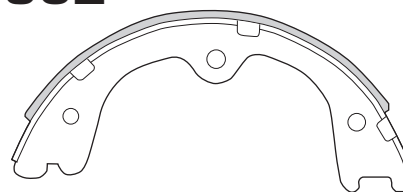

LN1902
(Parking)

a	b	c	r
6	1.6	25	95.2

4pcs.

FN-1299

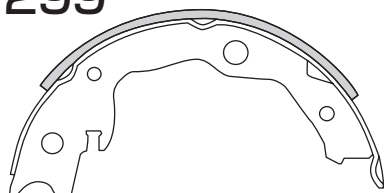

LN1299

a	b	c	r
4.5	2	20	86.6

4pcs.

FN-1903

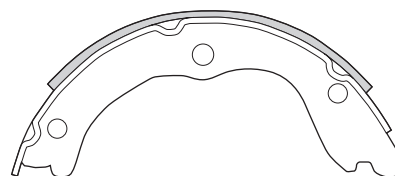

LN1903
(Parking)

a	b	c	r
6	1.6	20	85.7



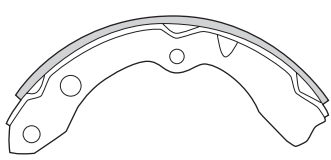
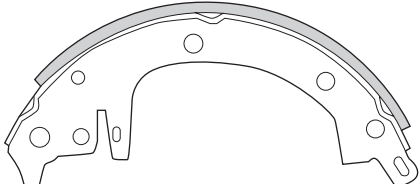
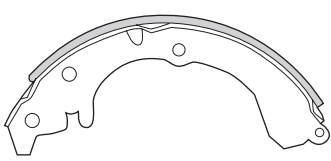
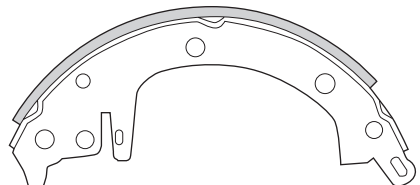
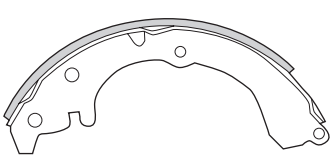
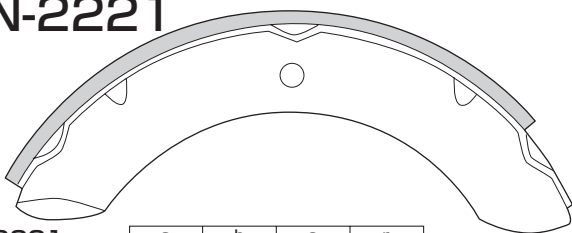
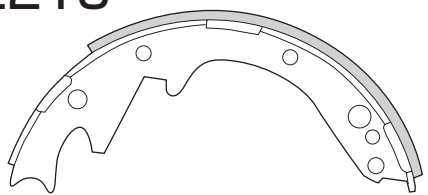
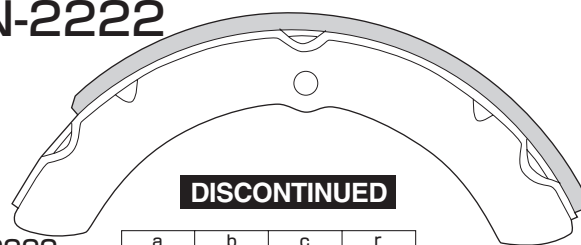
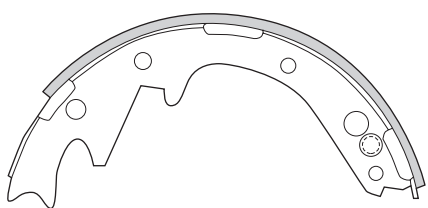
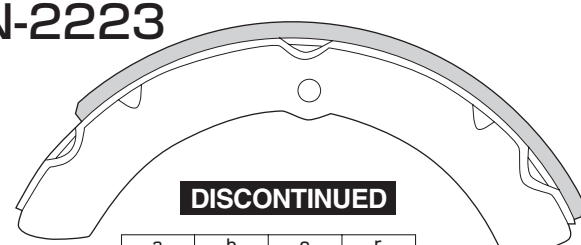
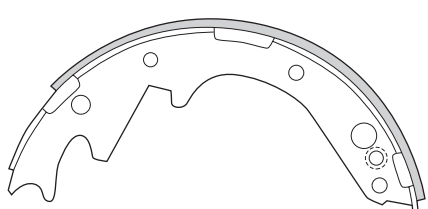
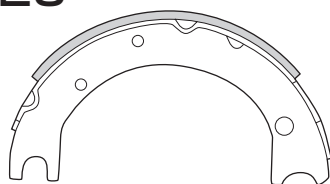

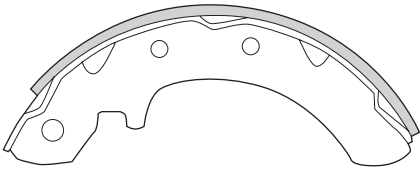
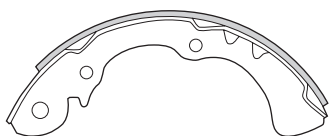
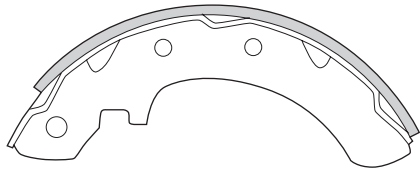
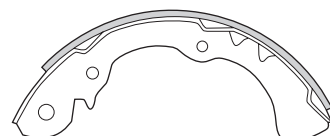
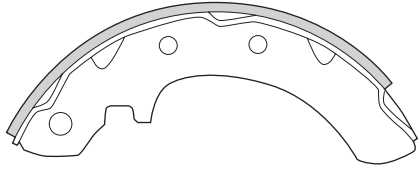
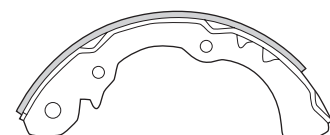
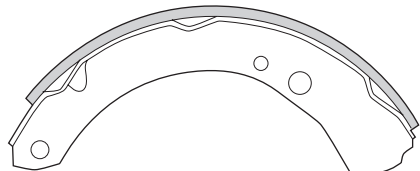
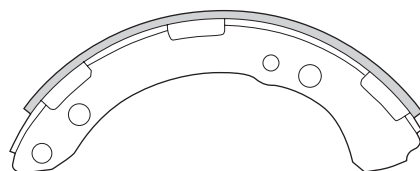
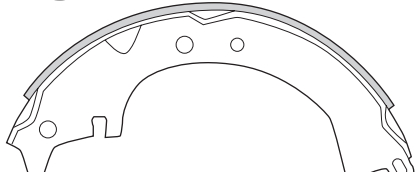
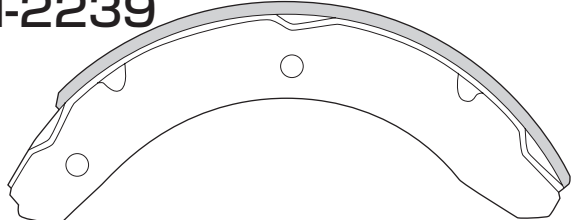
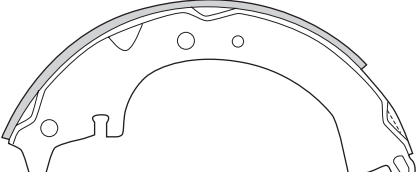

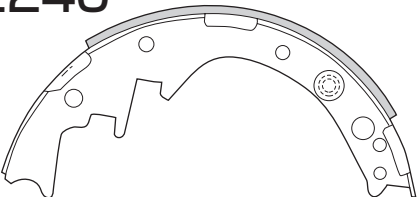
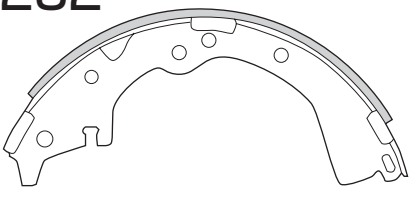
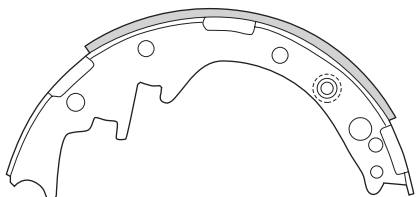
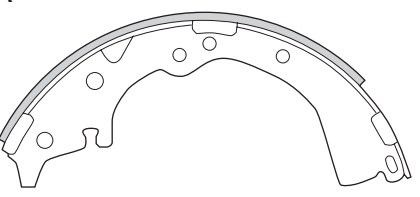
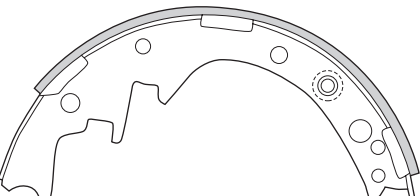
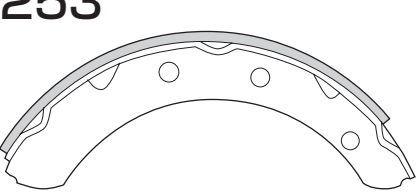
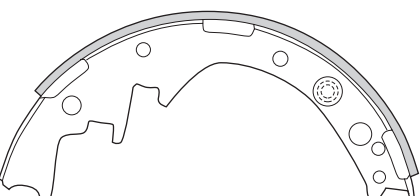
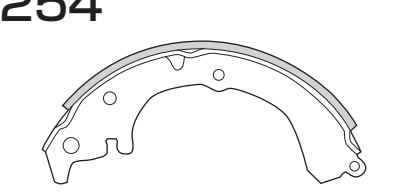
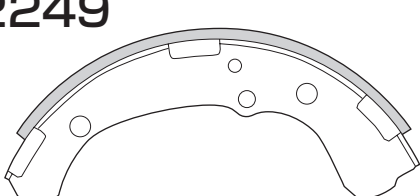
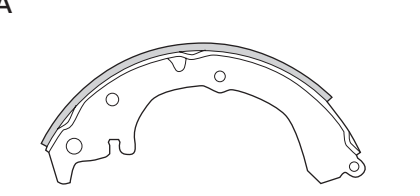
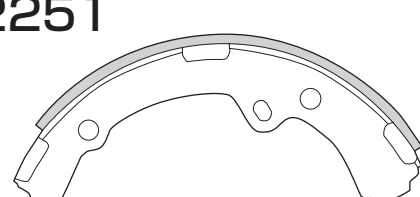
4pcs.

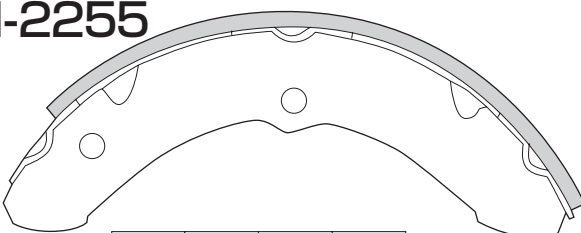
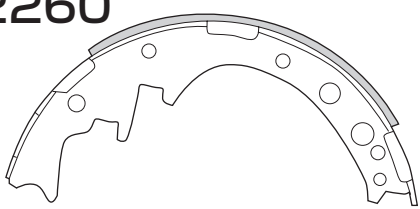
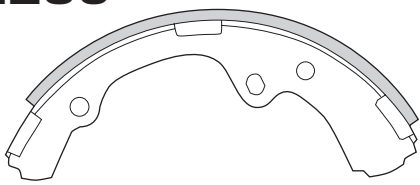
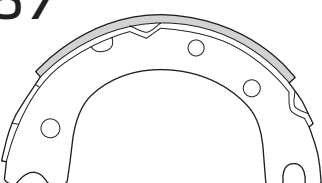
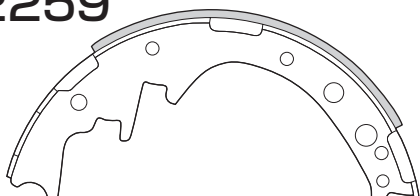
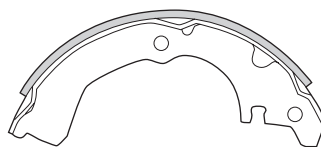
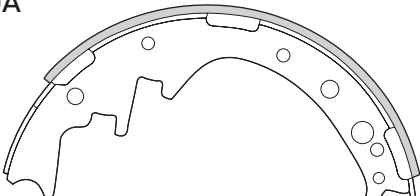
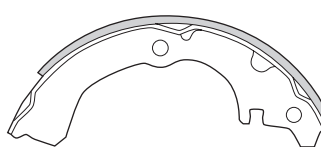
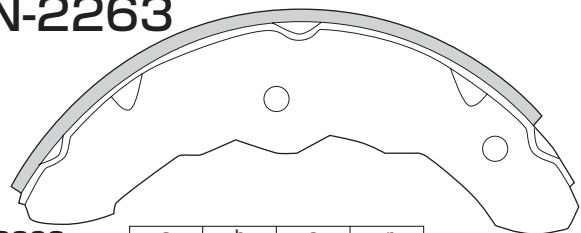
<p>FN-2202</p>  <p>LN2202(Front)</p> <table border="1" data-bbox="412 523 707 584"> <thead> <tr> <th>a</th> <th>b</th> <th>c</th> <th>r</th> </tr> </thead> <tbody> <tr> <td>3.2</td> <td>2</td> <td>40</td> <td>100</td> </tr> </tbody> </table> <p>4pcs.</p>	a	b	c	r	3.2	2	40	100	<p>FN-2220A</p>  <p>LN2220A (Rear)</p> <table border="1" data-bbox="1084 523 1379 584"> <thead> <tr> <th>a</th> <th>b</th> <th>c</th> <th>r</th> </tr> </thead> <tbody> <tr> <td>4</td> <td>2.3</td> <td>40</td> <td>114.3</td> </tr> </tbody> </table> <p>2pcs.</p>	a	b	c	r	4	2.3	40	114.3
a	b	c	r														
3.2	2	40	100														
a	b	c	r														
4	2.3	40	114.3														
<p>FN-2203</p>  <p>LN2203 (Rear)</p> <table border="1" data-bbox="412 840 707 901"> <thead> <tr> <th>a</th> <th>b</th> <th>c</th> <th>r</th> </tr> </thead> <tbody> <tr> <td>3.2</td> <td>2</td> <td>35</td> <td>100</td> </tr> </tbody> </table> <p>2pcs.</p>	a	b	c	r	3.2	2	35	100	<p>LN2220B</p>  <table border="1" data-bbox="1084 840 1379 901"> <thead> <tr> <th>a</th> <th>b</th> <th>c</th> <th>r</th> </tr> </thead> <tbody> <tr> <td>4</td> <td>2.3</td> <td>40</td> <td>114.3</td> </tr> </tbody> </table> <p>2pcs.</p>	a	b	c	r	4	2.3	40	114.3
a	b	c	r														
3.2	2	35	100														
a	b	c	r														
4	2.3	40	114.3														
<p>LN2203A</p>  <table border="1" data-bbox="412 1157 707 1218"> <thead> <tr> <th>a</th> <th>b</th> <th>c</th> <th>r</th> </tr> </thead> <tbody> <tr> <td>3.2</td> <td>2</td> <td>35</td> <td>100</td> </tr> </tbody> </table> <p>2pcs.</p>	a	b	c	r	3.2	2	35	100	<p>FN-2221</p>  <p>LN2221 (Front & Rear)</p> <table border="1" data-bbox="1084 1157 1379 1218"> <thead> <tr> <th>a</th> <th>b</th> <th>c</th> <th>r</th> </tr> </thead> <tbody> <tr> <td>4.5</td> <td>2.3</td> <td>55</td> <td>145</td> </tr> </tbody> </table> <p>4pcs.</p>	a	b	c	r	4.5	2.3	55	145
a	b	c	r														
3.2	2	35	100														
a	b	c	r														
4.5	2.3	55	145														
<p>FN-2210</p>  <p>LN2210 (Front&Rear)</p> <table border="1" data-bbox="412 1473 707 1534"> <thead> <tr> <th>a</th> <th>b</th> <th>c</th> <th>r</th> </tr> </thead> <tbody> <tr> <td>4.5</td> <td>2</td> <td>40</td> <td>114.3</td> </tr> </tbody> </table> <p>2pcs.</p>	a	b	c	r	4.5	2	40	114.3	<p>FN-2222</p>  <p>DISCONTINUED</p> <p>LN2222 (Front & Rear)</p> <table border="1" data-bbox="1084 1473 1379 1534"> <thead> <tr> <th>a</th> <th>b</th> <th>c</th> <th>r</th> </tr> </thead> <tbody> <tr> <td>6</td> <td>3.2</td> <td>65</td> <td>160</td> </tr> </tbody> </table> <p>4pcs.</p>	a	b	c	r	6	3.2	65	160
a	b	c	r														
4.5	2	40	114.3														
a	b	c	r														
6	3.2	65	160														
<p>LN2211</p>  <table border="1" data-bbox="412 1790 707 1851"> <thead> <tr> <th>a</th> <th>b</th> <th>c</th> <th>r</th> </tr> </thead> <tbody> <tr> <td>4.5</td> <td>2</td> <td>40</td> <td>114.3</td> </tr> </tbody> </table> <p>1 pc.</p>	a	b	c	r	4.5	2	40	114.3	<p>FN-2223</p>  <p>DISCONTINUED</p> <p>LN2223(Rear)</p> <table border="1" data-bbox="1084 1790 1379 1851"> <thead> <tr> <th>a</th> <th>b</th> <th>c</th> <th>r</th> </tr> </thead> <tbody> <tr> <td>6</td> <td>3.2</td> <td>85</td> <td>160</td> </tr> </tbody> </table> <p>4pcs.</p>	a	b	c	r	6	3.2	85	160
a	b	c	r														
4.5	2	40	114.3														
a	b	c	r														
6	3.2	85	160														
<p>LN2212</p>  <table border="1" data-bbox="412 2107 707 2168"> <thead> <tr> <th>a</th> <th>b</th> <th>c</th> <th>r</th> </tr> </thead> <tbody> <tr> <td>4.5</td> <td>2</td> <td>40</td> <td>114.3</td> </tr> </tbody> </table> <p>1 pc.</p>	a	b	c	r	4.5	2	40	114.3	<p>FN-2225</p>  <p>LN2225 (Parking)</p> <table border="1" data-bbox="1084 2107 1379 2168"> <thead> <tr> <th>a</th> <th>b</th> <th>c</th> <th>r</th> </tr> </thead> <tbody> <tr> <td>3.2</td> <td>1.6</td> <td>35</td> <td>80</td> </tr> </tbody> </table> <p>2pcs.</p>	a	b	c	r	3.2	1.6	35	80
a	b	c	r														
4.5	2	40	114.3														
a	b	c	r														
3.2	1.6	35	80														

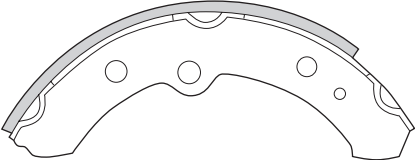
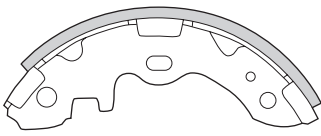
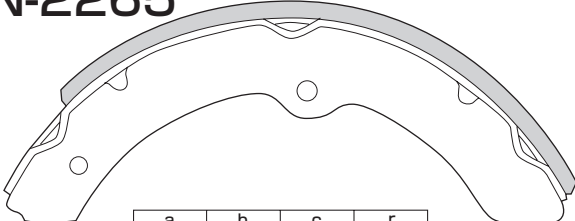
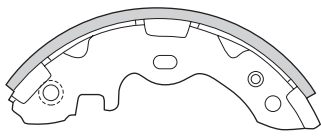
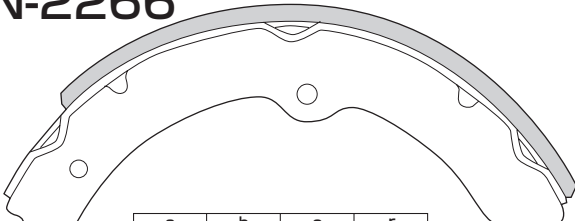
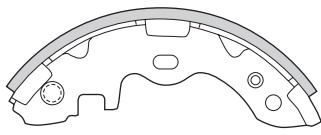
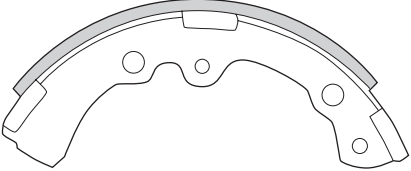
<p>FN-2228A</p>  <p>LN2228 (Front)</p> <table border="1" data-bbox="421 531 716 584"> <thead> <tr><th>a</th><th>b</th><th>c</th><th>r</th></tr> </thead> <tbody> <tr><td>4.5</td><td>2.3</td><td>51</td><td>115</td></tr> </tbody> </table> <p>4pcs.</p>	a	b	c	r	4.5	2.3	51	115	<p>FN-2237A</p>  <p>LN2237 (Front)</p> <table border="1" data-bbox="1084 531 1379 584"> <thead> <tr><th>a</th><th>b</th><th>c</th><th>r</th></tr> </thead> <tbody> <tr><td>3.2</td><td>1.6</td><td>30</td><td>100</td></tr> </tbody> </table> <p>4pcs.</p>	a	b	c	r	3.2	1.6	30	100
a	b	c	r														
4.5	2.3	51	115														
a	b	c	r														
3.2	1.6	30	100														
<p>FN-2228B</p>  <p>LN2228 (Rear)</p> <table border="1" data-bbox="421 847 716 901"> <thead> <tr><th>a</th><th>b</th><th>c</th><th>r</th></tr> </thead> <tbody> <tr><td>4.5</td><td>2.3</td><td>51</td><td>115</td></tr> </tbody> </table> <p>2pcs.</p>	a	b	c	r	4.5	2.3	51	115	<p>FN-2237B</p>  <p>LN2237 (Rear)</p> <table border="1" data-bbox="1084 847 1379 901"> <thead> <tr><th>a</th><th>b</th><th>c</th><th>r</th></tr> </thead> <tbody> <tr><td>3.2</td><td>1.6</td><td>30</td><td>100</td></tr> </tbody> </table> <p>2pcs.</p>	a	b	c	r	3.2	1.6	30	100
a	b	c	r														
4.5	2.3	51	115														
a	b	c	r														
3.2	1.6	30	100														
<p>LN2228A</p>  <table border="1" data-bbox="421 1164 716 1218"> <thead> <tr><th>a</th><th>b</th><th>c</th><th>r</th></tr> </thead> <tbody> <tr><td>4.5</td><td>2.3</td><td>51</td><td>115</td></tr> </tbody> </table> <p>2pcs.</p>	a	b	c	r	4.5	2.3	51	115	<p>LN2237A</p>  <table border="1" data-bbox="1084 1164 1379 1218"> <thead> <tr><th>a</th><th>b</th><th>c</th><th>r</th></tr> </thead> <tbody> <tr><td>3.2</td><td>1.6</td><td>30</td><td>100</td></tr> </tbody> </table> <p>2pcs.</p>	a	b	c	r	3.2	1.6	30	100
a	b	c	r														
4.5	2.3	51	115														
a	b	c	r														
3.2	1.6	30	100														
<p>FN-2231</p>  <p>LN2231 (Front)</p> <table border="1" data-bbox="421 1485 716 1539"> <thead> <tr><th>a</th><th>b</th><th>c</th><th>r</th></tr> </thead> <tbody> <tr><td>4</td><td>2</td><td>45</td><td>114.3</td></tr> </tbody> </table> <p>4pcs.</p>	a	b	c	r	4	2	45	114.3	<p>FN-2238</p>  <p>LN2238 (Front)</p> <table border="1" data-bbox="1084 1485 1379 1539"> <thead> <tr><th>a</th><th>b</th><th>c</th><th>r</th></tr> </thead> <tbody> <tr><td>4</td><td>2</td><td>50</td><td>114.3</td></tr> </tbody> </table> <p>4pcs.</p>	a	b	c	r	4	2	50	114.3
a	b	c	r														
4	2	45	114.3														
a	b	c	r														
4	2	50	114.3														
<p>FN-2232</p>  <p>LN2232 (Rear)</p> <table border="1" data-bbox="421 1802 716 1856"> <thead> <tr><th>a</th><th>b</th><th>c</th><th>r</th></tr> </thead> <tbody> <tr><td>4</td><td>2</td><td>40</td><td>114.3</td></tr> </tbody> </table> <p>2pcs.</p>	a	b	c	r	4	2	40	114.3	<p>FN-2239</p>  <p>LN2239 (Front & Rear)</p> <table border="1" data-bbox="1084 1802 1379 1856"> <thead> <tr><th>a</th><th>b</th><th>c</th><th>r</th></tr> </thead> <tbody> <tr><td>4.5</td><td>2.3</td><td>60</td><td>145</td></tr> </tbody> </table> <p>4pcs.</p>	a	b	c	r	4.5	2.3	60	145
a	b	c	r														
4	2	40	114.3														
a	b	c	r														
4.5	2.3	60	145														
<p>LN2232A</p>  <table border="1" data-bbox="421 2119 716 2172"> <thead> <tr><th>a</th><th>b</th><th>c</th><th>r</th></tr> </thead> <tbody> <tr><td>4</td><td>2</td><td>40</td><td>114.3</td></tr> </tbody> </table> <p>2pcs.</p>	a	b	c	r	4	2	40	114.3									
a	b	c	r														
4	2	40	114.3														

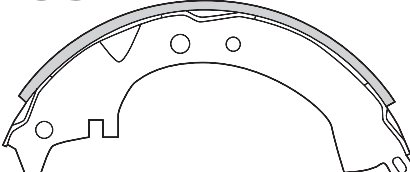
<p>FN-2240</p>  <p>LN2240 (Rear)</p> <table border="1" data-bbox="412 531 713 589"> <thead> <tr> <th>a</th> <th>b</th> <th>c</th> <th>r</th> </tr> </thead> <tbody> <tr> <td>6</td> <td>2.3</td> <td>56</td> <td>127</td> </tr> </tbody> </table> <p>1 pc.</p>	a	b	c	r	6	2.3	56	127	<p>FN-2252</p>  <p>LN2252 (Rear)</p> <table border="1" data-bbox="1093 531 1394 589"> <thead> <tr> <th>a</th> <th>b</th> <th>c</th> <th>r</th> </tr> </thead> <tbody> <tr> <td>4.5</td> <td>2.3</td> <td>50</td> <td>127</td> </tr> </tbody> </table> <p>2 pcs.</p>	a	b	c	r	4.5	2.3	50	127
a	b	c	r														
6	2.3	56	127														
a	b	c	r														
4.5	2.3	50	127														
<p>LN2241</p>  <table border="1" data-bbox="412 847 713 906"> <thead> <tr> <th>a</th> <th>b</th> <th>c</th> <th>r</th> </tr> </thead> <tbody> <tr> <td>6</td> <td>2.3</td> <td>56</td> <td>127</td> </tr> </tbody> </table> <p>1 pc.</p>	a	b	c	r	6	2.3	56	127	<p>LN2252A</p>  <table border="1" data-bbox="1093 847 1394 906"> <thead> <tr> <th>a</th> <th>b</th> <th>c</th> <th>r</th> </tr> </thead> <tbody> <tr> <td>4.5</td> <td>2.3</td> <td>50</td> <td>127</td> </tr> </tbody> </table> <p>2 pcs.</p>	a	b	c	r	4.5	2.3	50	127
a	b	c	r														
6	2.3	56	127														
a	b	c	r														
4.5	2.3	50	127														
<p>LN2241A</p>  <table border="1" data-bbox="412 1164 713 1222"> <thead> <tr> <th>a</th> <th>b</th> <th>c</th> <th>r</th> </tr> </thead> <tbody> <tr> <td>6</td> <td>2.3</td> <td>56</td> <td>127</td> </tr> </tbody> </table> <p>1 pc.</p>	a	b	c	r	6	2.3	56	127	<p>FN-2253</p>  <p>LN2253(Front)</p> <table border="1" data-bbox="1093 1164 1394 1222"> <thead> <tr> <th>a</th> <th>b</th> <th>c</th> <th>r</th> </tr> </thead> <tbody> <tr> <td>4.5</td> <td>2.3</td> <td>50</td> <td>114.3</td> </tr> </tbody> </table> <p>4 pcs.</p>	a	b	c	r	4.5	2.3	50	114.3
a	b	c	r														
6	2.3	56	127														
a	b	c	r														
4.5	2.3	50	114.3														
<p>LN2240A</p>  <table border="1" data-bbox="412 1481 713 1539"> <thead> <tr> <th>a</th> <th>b</th> <th>c</th> <th>r</th> </tr> </thead> <tbody> <tr> <td>6</td> <td>2.3</td> <td>56</td> <td>127</td> </tr> </tbody> </table> <p>1 pc.</p>	a	b	c	r	6	2.3	56	127	<p>FN-2254</p>  <p>LN2254 (Rear)</p> <table border="1" data-bbox="1093 1481 1394 1539"> <thead> <tr> <th>a</th> <th>b</th> <th>c</th> <th>r</th> </tr> </thead> <tbody> <tr> <td>3.2</td> <td>2</td> <td>30</td> <td>100</td> </tr> </tbody> </table> <p>2 pcs.</p>	a	b	c	r	3.2	2	30	100
a	b	c	r														
6	2.3	56	127														
a	b	c	r														
3.2	2	30	100														
<p>FN-2249</p>  <p>LN2249(Front)</p> <table border="1" data-bbox="412 1797 713 1856"> <thead> <tr> <th>a</th> <th>b</th> <th>c</th> <th>r</th> </tr> </thead> <tbody> <tr> <td>4.5</td> <td>2.3</td> <td>56</td> <td>127</td> </tr> </tbody> </table> <p>4 pcs.</p>	a	b	c	r	4.5	2.3	56	127	<p>LN2254A</p>  <table border="1" data-bbox="1093 1797 1394 1856"> <thead> <tr> <th>a</th> <th>b</th> <th>c</th> <th>r</th> </tr> </thead> <tbody> <tr> <td>3.2</td> <td>2</td> <td>30</td> <td>100</td> </tr> </tbody> </table> <p>2 pcs.</p>	a	b	c	r	3.2	2	30	100
a	b	c	r														
4.5	2.3	56	127														
a	b	c	r														
3.2	2	30	100														
<p>FN-2251</p>  <p>LN2251 (Front)</p> <table border="1" data-bbox="412 2114 713 2172"> <thead> <tr> <th>a</th> <th>b</th> <th>c</th> <th>r</th> </tr> </thead> <tbody> <tr> <td>4.5</td> <td>2.3</td> <td>61</td> <td>127</td> </tr> </tbody> </table> <p>4 pcs.</p>	a	b	c	r	4.5	2.3	61	127									
a	b	c	r														
4.5	2.3	61	127														

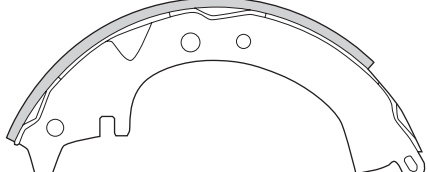

<p>FN-2255</p>  <p>LN2255 (Front & Rear)</p> <table border="1" data-bbox="412 523 707 584"> <thead> <tr> <th>a</th> <th>b</th> <th>c</th> <th>r</th> </tr> </thead> <tbody> <tr> <td>4.5</td> <td>2.3</td> <td>75</td> <td>147.5</td> </tr> </tbody> </table> <p>4pcs.</p>	a	b	c	r	4.5	2.3	75	147.5	<p>FN-2260</p>  <p>LN2259 (Rear)</p> <table border="1" data-bbox="1084 523 1388 584"> <thead> <tr> <th>a</th> <th>b</th> <th>c</th> <th>r</th> </tr> </thead> <tbody> <tr> <td>6</td> <td>2.3</td> <td>56</td> <td>127</td> </tr> </tbody> </table> <p>2pcs.</p>	a	b	c	r	6	2.3	56	127
a	b	c	r														
4.5	2.3	75	147.5														
a	b	c	r														
6	2.3	56	127														
<p>FN-2256</p>  <p>LN2256(Front)</p> <table border="1" data-bbox="412 840 707 901"> <thead> <tr> <th>a</th> <th>b</th> <th>c</th> <th>r</th> </tr> </thead> <tbody> <tr> <td>4.5</td> <td>2.3</td> <td>50</td> <td>127</td> </tr> </tbody> </table> <p>4pcs.</p>	a	b	c	r	4.5	2.3	50	127	<p>LN2260</p> <table border="1" data-bbox="1084 840 1388 901"> <thead> <tr> <th>a</th> <th>b</th> <th>c</th> <th>r</th> </tr> </thead> <tbody> <tr> <td>6</td> <td>2.3</td> <td>56</td> <td>127</td> </tr> </tbody> </table> <p>1pc.</p>	a	b	c	r	6	2.3	56	127
a	b	c	r														
4.5	2.3	50	127														
a	b	c	r														
6	2.3	56	127														
<p>FN-2257</p>  <p>LN2257 (Parking)</p> <table border="1" data-bbox="412 1157 707 1218"> <thead> <tr> <th>a</th> <th>b</th> <th>c</th> <th>r</th> </tr> </thead> <tbody> <tr> <td>4.5</td> <td>2</td> <td>35</td> <td>80</td> </tr> </tbody> </table> <p>2pcs.</p>	a	b	c	r	4.5	2	35	80	<p>LN2261</p> <table border="1" data-bbox="1084 1157 1388 1218"> <thead> <tr> <th>a</th> <th>b</th> <th>c</th> <th>r</th> </tr> </thead> <tbody> <tr> <td>6</td> <td>2.3</td> <td>56</td> <td>127</td> </tr> </tbody> </table> <p>1pc.</p>	a	b	c	r	6	2.3	56	127
a	b	c	r														
4.5	2	35	80														
a	b	c	r														
6	2.3	56	127														
<p>FN-2259</p>  <p>LN2259 (Rear)</p> <table border="1" data-bbox="412 1473 707 1534"> <thead> <tr> <th>a</th> <th>b</th> <th>c</th> <th>r</th> </tr> </thead> <tbody> <tr> <td>6</td> <td>2.3</td> <td>56</td> <td>127</td> </tr> </tbody> </table> <p>2pcs.</p>	a	b	c	r	6	2.3	56	127	<p>FN-2262</p>  <p>LN2262 (Rear)</p> <table border="1" data-bbox="1084 1473 1388 1534"> <thead> <tr> <th>a</th> <th>b</th> <th>c</th> <th>r</th> </tr> </thead> <tbody> <tr> <td>3.2</td> <td>2</td> <td>30</td> <td>90</td> </tr> </tbody> </table> <p>2pcs.</p>	a	b	c	r	3.2	2	30	90
a	b	c	r														
6	2.3	56	127														
a	b	c	r														
3.2	2	30	90														
<p>LN2259A</p>  <table border="1" data-bbox="412 1790 707 1851"> <thead> <tr> <th>a</th> <th>b</th> <th>c</th> <th>r</th> </tr> </thead> <tbody> <tr> <td>6</td> <td>2.3</td> <td>56</td> <td>127</td> </tr> </tbody> </table> <p>2pcs.</p>	a	b	c	r	6	2.3	56	127	<p>LN2262A</p>  <table border="1" data-bbox="1084 1790 1388 1851"> <thead> <tr> <th>a</th> <th>b</th> <th>c</th> <th>r</th> </tr> </thead> <tbody> <tr> <td>3.2</td> <td>2</td> <td>30</td> <td>90</td> </tr> </tbody> </table> <p>2pcs.</p>	a	b	c	r	3.2	2	30	90
a	b	c	r														
6	2.3	56	127														
a	b	c	r														
3.2	2	30	90														
<p>FN-2263</p>  <p>LN2263 (Front & Rear)</p> <table border="1" data-bbox="1084 2119 1388 2180"> <thead> <tr> <th>a</th> <th>b</th> <th>c</th> <th>r</th> </tr> </thead> <tbody> <tr> <td>4.5</td> <td>2.3</td> <td>75</td> <td>147.5</td> </tr> </tbody> </table> <p>4pcs.</p>		a	b	c	r	4.5	2.3	75	147.5								
a	b	c	r														
4.5	2.3	75	147.5														

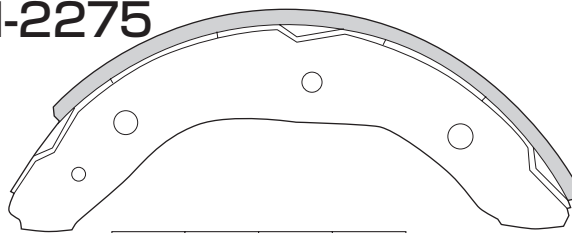
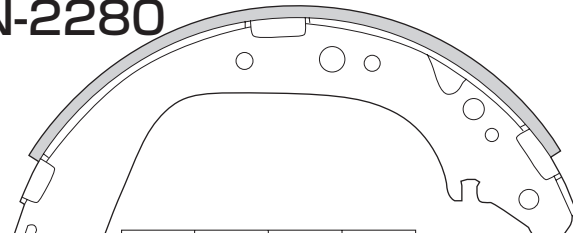
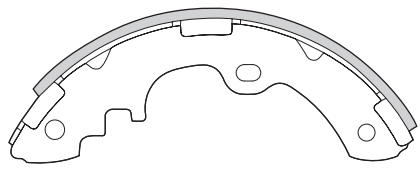
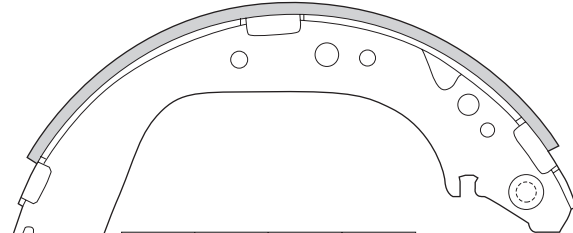
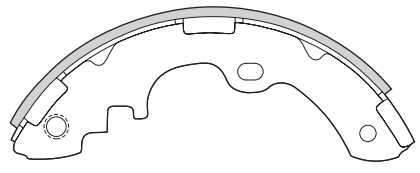
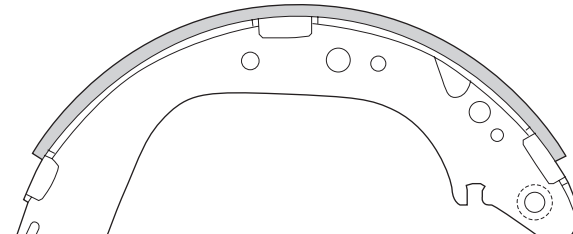
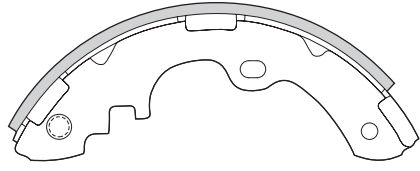
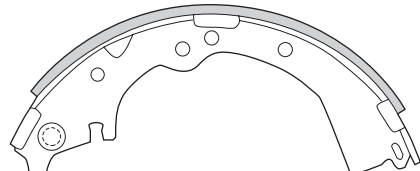
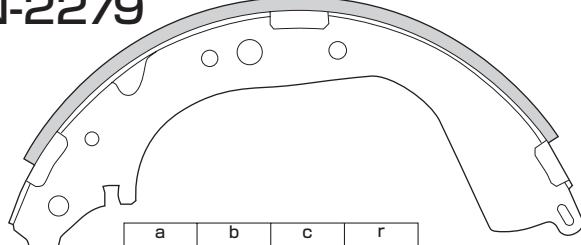
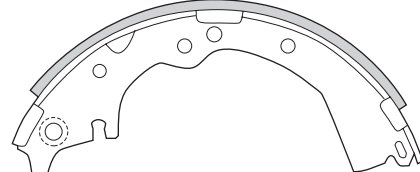
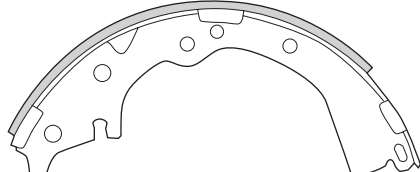

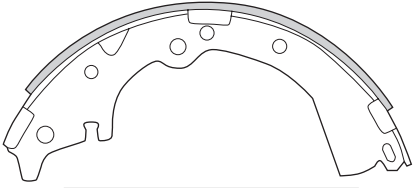
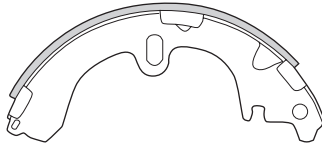
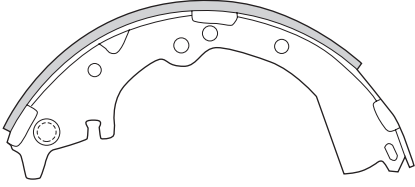
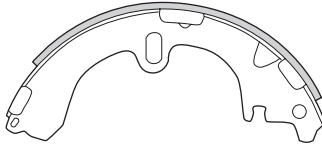
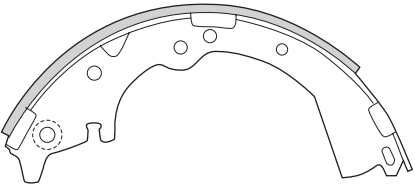
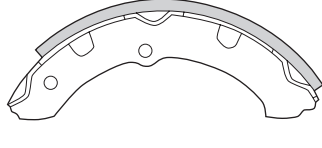
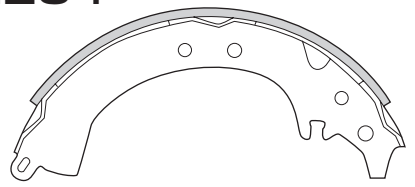
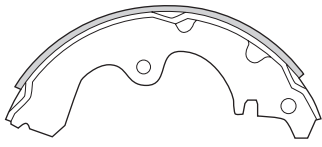
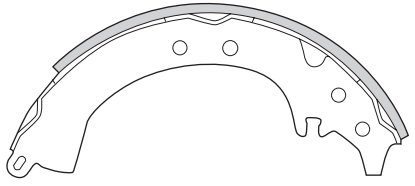
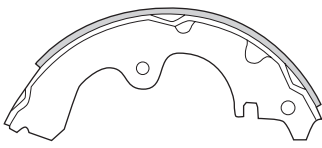

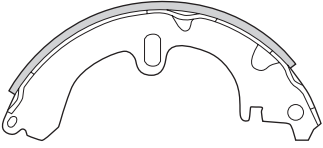
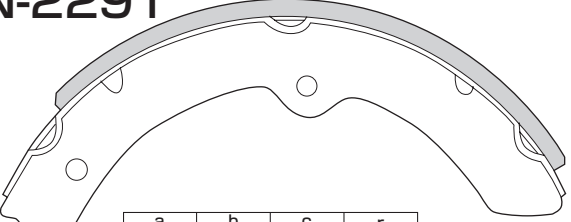
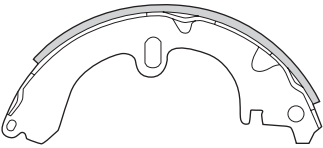
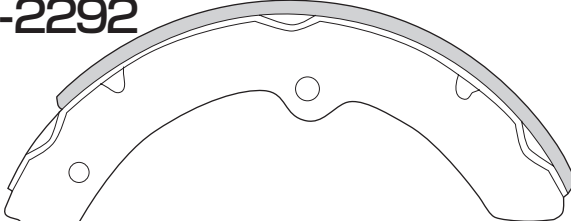
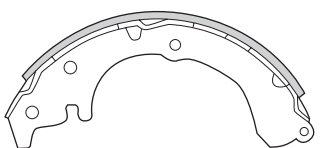
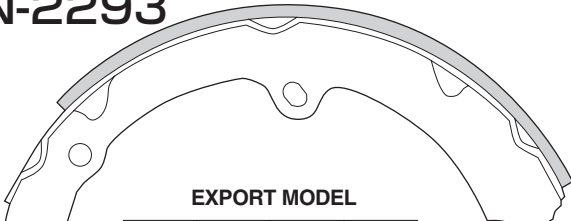
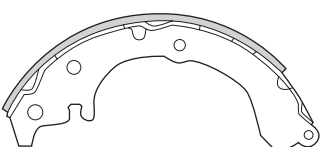
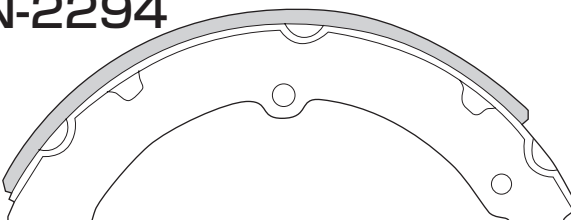
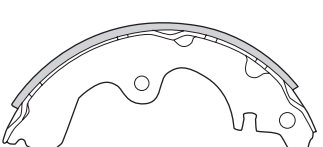
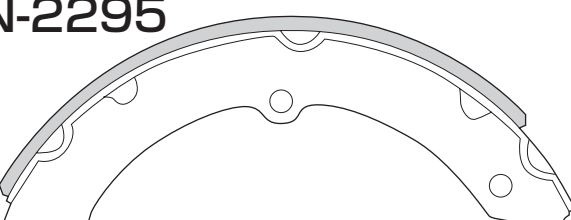
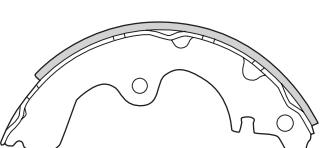
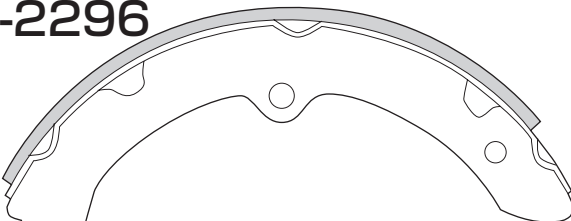
<h3>FN-2264</h3>  <table border="1" data-bbox="412 531 713 584"> <tr><th>a</th><th>b</th><th>c</th><th>r</th></tr> <tr><td>4.5</td><td>2.3</td><td>70</td><td>122</td></tr> </table> <p>LN2264(Rear) 4pcs.</p>	a	b	c	r	4.5	2.3	70	122	<h3>FN-2269</h3>  <table border="1" data-bbox="1093 531 1388 584"> <tr><th>a</th><th>b</th><th>c</th><th>r</th></tr> <tr><td>4.5</td><td>2.3</td><td>55</td><td>90</td></tr> </table> <p>LN2269 (Rear) 2pcs.</p>	a	b	c	r	4.5	2.3	55	90
a	b	c	r														
4.5	2.3	70	122														
a	b	c	r														
4.5	2.3	55	90														
<h3>FN-2265</h3>  <table border="1" data-bbox="412 847 713 901"> <tr><th>a</th><th>b</th><th>c</th><th>r</th></tr> <tr><td>6</td><td>3.2</td><td>65</td><td>160</td></tr> </table> <p>LN2265(Front) 4pcs.</p>	a	b	c	r	6	3.2	65	160	 <table border="1" data-bbox="1093 847 1388 901"> <tr><th>a</th><th>b</th><th>c</th><th>r</th></tr> <tr><td>4.5</td><td>2.3</td><td>55</td><td>90</td></tr> </table> <p>LN2270 1pc.</p>	a	b	c	r	4.5	2.3	55	90
a	b	c	r														
6	3.2	65	160														
a	b	c	r														
4.5	2.3	55	90														
<h3>FN-2266</h3>  <table border="1" data-bbox="412 1169 713 1222"> <tr><th>a</th><th>b</th><th>c</th><th>r</th></tr> <tr><td>6</td><td>3.2</td><td>85</td><td>160</td></tr> </table> <p>LN2266(Rear) 4pcs.</p>	a	b	c	r	6	3.2	85	160	 <table border="1" data-bbox="1093 1169 1388 1222"> <tr><th>a</th><th>b</th><th>c</th><th>r</th></tr> <tr><td>4.5</td><td>2.3</td><td>55</td><td>90</td></tr> </table> <p>LN2271 1pc.</p>	a	b	c	r	4.5	2.3	55	90
a	b	c	r														
6	3.2	85	160														
a	b	c	r														
4.5	2.3	55	90														
<h3>FN-2267</h3>  <table border="1" data-bbox="412 1485 713 1539"> <tr><th>a</th><th>b</th><th>c</th><th>r</th></tr> <tr><td>4</td><td>2</td><td>50</td><td>114.3</td></tr> </table> <p>LN2267(Front) 4pcs.</p>	a	b	c	r	4	2	50	114.3	<h3>FN-2272</h3>  <table border="1" data-bbox="1084 1485 1379 1539"> <tr><th>a</th><th>b</th><th>c</th><th>r</th></tr> <tr><td>4.5</td><td>2.3</td><td>50</td><td>115</td></tr> </table> <p>LN2272 (Rear) 2pcs.</p>	a	b	c	r	4.5	2.3	50	115
a	b	c	r														
4	2	50	114.3														
a	b	c	r														
4.5	2.3	50	115														
<h3>FN-2268</h3>  <table border="1" data-bbox="412 1802 713 1856"> <tr><th>a</th><th>b</th><th>c</th><th>r</th></tr> <tr><td>4</td><td>2</td><td>45</td><td>114.3</td></tr> </table> <p>LN2268 (Rear) 2pcs.</p>	a	b	c	r	4	2	45	114.3	 <table border="1" data-bbox="1084 1802 1379 1856"> <tr><th>a</th><th>b</th><th>c</th><th>r</th></tr> <tr><td>4.5</td><td>2.3</td><td>50</td><td>115</td></tr> </table> <p>LN2273 1pc.</p>	a	b	c	r	4.5	2.3	50	115
a	b	c	r														
4	2	45	114.3														
a	b	c	r														
4.5	2.3	50	115														
<p>LN2268A 2pcs.</p>  <table border="1" data-bbox="412 2119 713 2172"> <tr><th>a</th><th>b</th><th>c</th><th>r</th></tr> <tr><td>4</td><td>2</td><td>45</td><td>114.3</td></tr> </table>	a	b	c	r	4	2	45	114.3	 <table border="1" data-bbox="1084 2119 1379 2172"> <tr><th>a</th><th>b</th><th>c</th><th>r</th></tr> <tr><td>4.5</td><td>2.3</td><td>50</td><td>115</td></tr> </table> <p>LN2274 1pc.</p>	a	b	c	r	4.5	2.3	50	115
a	b	c	r														
4	2	45	114.3														
a	b	c	r														
4.5	2.3	50	115														

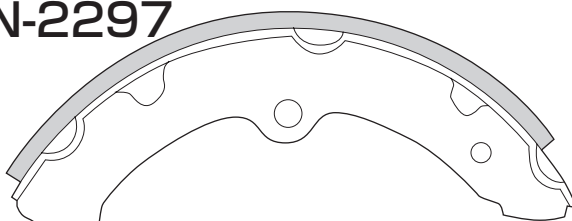
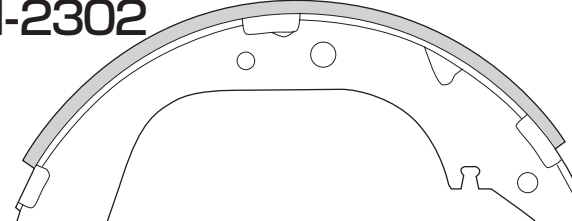
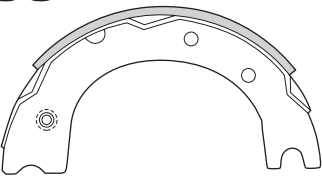
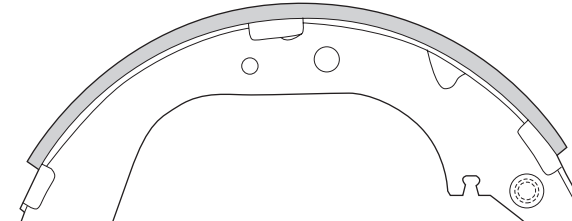
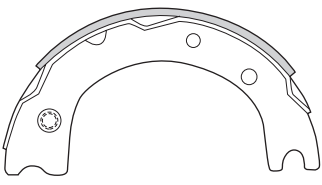
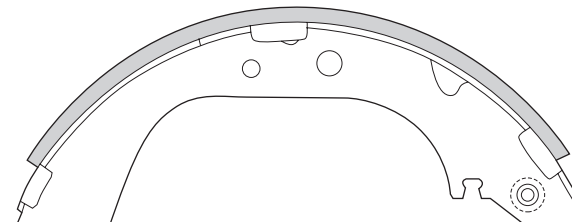
<p>FN-2275</p>  <p>LN2275 (Front & Rear)</p> <table border="1" data-bbox="412 523 707 584"> <tr><th>a</th><th>b</th><th>c</th><th>r</th></tr> <tr><td>4.5</td><td>2.3</td><td>60</td><td>145</td></tr> </table> <p>4pcs.</p>	a	b	c	r	4.5	2.3	60	145	<p>FN-2280</p>  <p>LN2279 (Rear)</p> <table border="1" data-bbox="1075 523 1370 584"> <tr><th>a</th><th>b</th><th>c</th><th>r</th></tr> <tr><td>4.5</td><td>2.3</td><td>60</td><td>147.5</td></tr> </table> <p>2pcs.</p>	a	b	c	r	4.5	2.3	60	147.5
a	b	c	r														
4.5	2.3	60	145														
a	b	c	r														
4.5	2.3	60	147.5														
<p>FN-2276</p>  <p>LN2276 (Rear)</p> <table border="1" data-bbox="412 840 707 901"> <tr><th>a</th><th>b</th><th>c</th><th>r</th></tr> <tr><td>4.5</td><td>2.3</td><td>60</td><td>112</td></tr> </table> <p>2pcs.</p>	a	b	c	r	4.5	2.3	60	112	<p>LN2280</p>  <table border="1" data-bbox="1075 840 1370 901"> <tr><th>a</th><th>b</th><th>c</th><th>r</th></tr> <tr><td>4.5</td><td>2.3</td><td>60</td><td>147.5</td></tr> </table> <p>1pc.</p>	a	b	c	r	4.5	2.3	60	147.5
a	b	c	r														
4.5	2.3	60	112														
a	b	c	r														
4.5	2.3	60	147.5														
<p>LN2277</p>  <table border="1" data-bbox="412 1157 707 1218"> <tr><th>a</th><th>b</th><th>c</th><th>r</th></tr> <tr><td>4.5</td><td>2.3</td><td>60</td><td>112</td></tr> </table> <p>1pc.</p>	a	b	c	r	4.5	2.3	60	112	<p>LN2281</p>  <table border="1" data-bbox="1075 1157 1370 1218"> <tr><th>a</th><th>b</th><th>c</th><th>r</th></tr> <tr><td>4.5</td><td>2.3</td><td>60</td><td>147.5</td></tr> </table> <p>1pc.</p>	a	b	c	r	4.5	2.3	60	147.5
a	b	c	r														
4.5	2.3	60	112														
a	b	c	r														
4.5	2.3	60	147.5														
<p>LN2278</p>  <table border="1" data-bbox="412 1473 707 1534"> <tr><th>a</th><th>b</th><th>c</th><th>r</th></tr> <tr><td>4.5</td><td>2.3</td><td>60</td><td>112</td></tr> </table> <p>1pc.</p>	a	b	c	r	4.5	2.3	60	112	<p>FN-2282</p>  <p>LN2282 (Rear)</p> <table border="1" data-bbox="1075 1473 1370 1534"> <tr><th>a</th><th>b</th><th>c</th><th>r</th></tr> <tr><td>4.5</td><td>2.3</td><td>50</td><td>127</td></tr> </table> <p>1pc.</p>	a	b	c	r	4.5	2.3	50	127
a	b	c	r														
4.5	2.3	60	112														
a	b	c	r														
4.5	2.3	50	127														
<p>FN-2279</p>  <p>LN2279(Rear)</p> <table border="1" data-bbox="412 1802 707 1863"> <tr><th>a</th><th>b</th><th>c</th><th>r</th></tr> <tr><td>4.5</td><td>2.3</td><td>60</td><td>147.5</td></tr> </table> <p>4pcs.</p>	a	b	c	r	4.5	2.3	60	147.5	<p>LN2283</p>  <table border="1" data-bbox="1075 1802 1370 1863"> <tr><th>a</th><th>b</th><th>c</th><th>r</th></tr> <tr><td>4.5</td><td>2.3</td><td>50</td><td>127</td></tr> </table> <p>1pc.</p>	a	b	c	r	4.5	2.3	50	127
a	b	c	r														
4.5	2.3	60	147.5														
a	b	c	r														
4.5	2.3	50	127														
	<p>LN2252A</p>  <table border="1" data-bbox="1075 2119 1370 2180"> <tr><th>a</th><th>b</th><th>c</th><th>r</th></tr> <tr><td>4.5</td><td>2.3</td><td>50</td><td>127</td></tr> </table> <p>2pcs.</p>	a	b	c	r	4.5	2.3	50	127								
a	b	c	r														
4.5	2.3	50	127														

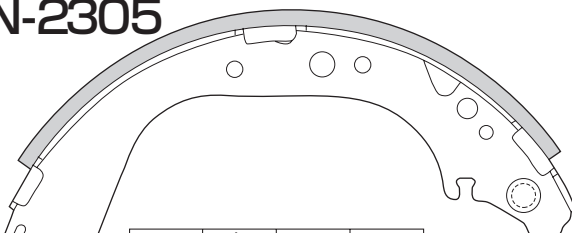
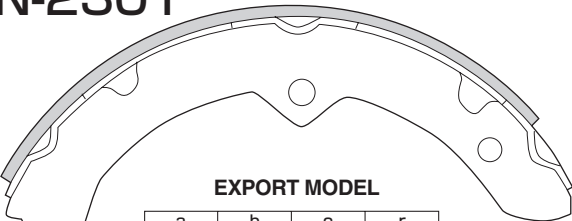
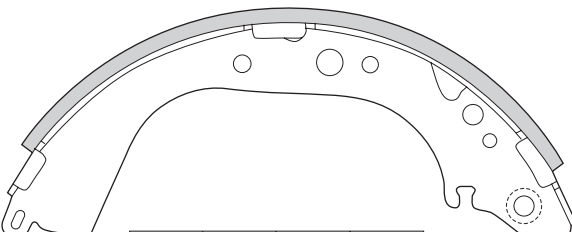
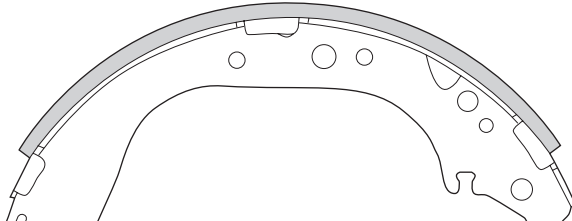
<p>FN-2282A</p>  <p>LN2252 (Rear)</p> <table border="1" data-bbox="417 531 715 587"> <thead> <tr> <th>a</th> <th>b</th> <th>c</th> <th>r</th> </tr> </thead> <tbody> <tr> <td>4.5</td> <td>2.3</td> <td>50</td> <td>127</td> </tr> </tbody> </table> <p>2pcs.</p>	a	b	c	r	4.5	2.3	50	127	<p>FN-2285</p>  <p>LN2285 (Rear)</p> <table border="1" data-bbox="1085 531 1383 587"> <thead> <tr> <th>a</th> <th>b</th> <th>c</th> <th>r</th> </tr> </thead> <tbody> <tr> <td>2.9</td> <td>1.6</td> <td>35</td> <td>100</td> </tr> </tbody> </table> <p>2pcs.</p>	a	b	c	r	2.9	1.6	35	100
a	b	c	r														
4.5	2.3	50	127														
a	b	c	r														
2.9	1.6	35	100														
<p>LN2282A</p>  <table border="1" data-bbox="417 850 715 906"> <thead> <tr> <th>a</th> <th>b</th> <th>c</th> <th>r</th> </tr> </thead> <tbody> <tr> <td>4.5</td> <td>2.3</td> <td>50</td> <td>127</td> </tr> </tbody> </table> <p>1pc.</p>	a	b	c	r	4.5	2.3	50	127	<p>LN2285A</p>  <table border="1" data-bbox="1085 850 1383 906"> <thead> <tr> <th>a</th> <th>b</th> <th>c</th> <th>r</th> </tr> </thead> <tbody> <tr> <td>2.9</td> <td>1.6</td> <td>35</td> <td>100</td> </tr> </tbody> </table> <p>2pcs.</p>	a	b	c	r	2.9	1.6	35	100
a	b	c	r														
4.5	2.3	50	127														
a	b	c	r														
2.9	1.6	35	100														
<p>LN2283A</p>  <table border="1" data-bbox="417 1166 715 1222"> <thead> <tr> <th>a</th> <th>b</th> <th>c</th> <th>r</th> </tr> </thead> <tbody> <tr> <td>4.5</td> <td>2.3</td> <td>50</td> <td>127</td> </tr> </tbody> </table> <p>1pc.</p>	a	b	c	r	4.5	2.3	50	127	<p>FN-2286</p>  <p>LN2286 (Rear)</p> <table border="1" data-bbox="1085 1176 1383 1232"> <thead> <tr> <th>a</th> <th>b</th> <th>c</th> <th>r</th> </tr> </thead> <tbody> <tr> <td>4.5</td> <td>2.3</td> <td>55</td> <td>112</td> </tr> </tbody> </table> <p>4pcs.</p>	a	b	c	r	4.5	2.3	55	112
a	b	c	r														
4.5	2.3	50	127														
a	b	c	r														
4.5	2.3	55	112														
<p>FN-2284</p>  <p>LN2284 (Rear)</p> <table border="1" data-bbox="417 1493 715 1549"> <thead> <tr> <th>a</th> <th>b</th> <th>c</th> <th>r</th> </tr> </thead> <tbody> <tr> <td>4</td> <td>2</td> <td>40</td> <td>114.3</td> </tr> </tbody> </table> <p>2pcs.</p>	a	b	c	r	4	2	40	114.3	<p>FN-2287</p>  <p>LN2287 (Rear)</p> <table border="1" data-bbox="1085 1493 1383 1549"> <thead> <tr> <th>a</th> <th>b</th> <th>c</th> <th>r</th> </tr> </thead> <tbody> <tr> <td>2.9</td> <td>2</td> <td>30</td> <td>90</td> </tr> </tbody> </table> <p>2pcs.</p>	a	b	c	r	2.9	2	30	90
a	b	c	r														
4	2	40	114.3														
a	b	c	r														
2.9	2	30	90														
<p>LN2284A</p>  <table border="1" data-bbox="417 1809 715 1865"> <thead> <tr> <th>a</th> <th>b</th> <th>c</th> <th>r</th> </tr> </thead> <tbody> <tr> <td>4</td> <td>2</td> <td>40</td> <td>114.3</td> </tr> </tbody> </table> <p>2pcs.</p>	a	b	c	r	4	2	40	114.3	<p>LN2287A</p>  <table border="1" data-bbox="1085 1809 1383 1865"> <thead> <tr> <th>a</th> <th>b</th> <th>c</th> <th>r</th> </tr> </thead> <tbody> <tr> <td>2.9</td> <td>2</td> <td>30</td> <td>90</td> </tr> </tbody> </table> <p>2pcs.</p>	a	b	c	r	2.9	2	30	90
a	b	c	r														
4	2	40	114.3														
a	b	c	r														
2.9	2	30	90														

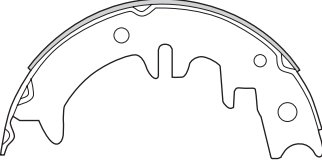
<p>FN-2288</p>  <p>LN2288 (Rear)</p> <table border="1" data-bbox="417 531 713 591"> <thead> <tr> <th>a</th> <th>b</th> <th>c</th> <th>r</th> </tr> </thead> <tbody> <tr> <td>2.9</td> <td>1.6</td> <td>30</td> <td>100</td> </tr> </tbody> </table>	a	b	c	r	2.9	1.6	30	100	<p>FN-2291</p>  <p>LN2291 (Front)</p> <table border="1" data-bbox="1089 531 1385 591"> <thead> <tr> <th>a</th> <th>b</th> <th>c</th> <th>r</th> </tr> </thead> <tbody> <tr> <td>6</td> <td>3.2</td> <td>75</td> <td>160</td> </tr> </tbody> </table>	a	b	c	r	6	3.2	75	160
a	b	c	r														
2.9	1.6	30	100														
a	b	c	r														
6	3.2	75	160														
<p>LN2288A</p>  <table border="1" data-bbox="417 847 713 908"> <thead> <tr> <th>a</th> <th>b</th> <th>c</th> <th>r</th> </tr> </thead> <tbody> <tr> <td>2.9</td> <td>1.6</td> <td>30</td> <td>100</td> </tr> </tbody> </table>	a	b	c	r	2.9	1.6	30	100	<p>2pcs.</p> <p>FN-2292</p>  <p>LN2292 (Front & Rear)</p> <table border="1" data-bbox="1089 847 1385 908"> <thead> <tr> <th>a</th> <th>b</th> <th>c</th> <th>r</th> </tr> </thead> <tbody> <tr> <td>6</td> <td>3.2</td> <td>90</td> <td>160</td> </tr> </tbody> </table>	a	b	c	r	6	3.2	90	160
a	b	c	r														
2.9	1.6	30	100														
a	b	c	r														
6	3.2	90	160														
<p>FN-2289</p>  <p>LN2289 (Rear)</p> <table border="1" data-bbox="417 1164 713 1225"> <thead> <tr> <th>a</th> <th>b</th> <th>c</th> <th>r</th> </tr> </thead> <tbody> <tr> <td>3.2</td> <td>2</td> <td>30</td> <td>100</td> </tr> </tbody> </table>	a	b	c	r	3.2	2	30	100	<p>2pcs.</p> <p>FN-2293</p>  <p>EXPORT MODEL</p> <p>LN2293 (Front)</p> <table border="1" data-bbox="1089 1164 1385 1225"> <thead> <tr> <th>a</th> <th>b</th> <th>c</th> <th>r</th> </tr> </thead> <tbody> <tr> <td>4.5</td> <td>2.3</td> <td>50</td> <td>139.7</td> </tr> </tbody> </table>	a	b	c	r	4.5	2.3	50	139.7
a	b	c	r														
3.2	2	30	100														
a	b	c	r														
4.5	2.3	50	139.7														
<p>LN2289A</p>  <table border="1" data-bbox="417 1481 713 1541"> <thead> <tr> <th>a</th> <th>b</th> <th>c</th> <th>r</th> </tr> </thead> <tbody> <tr> <td>3.2</td> <td>2</td> <td>30</td> <td>100</td> </tr> </tbody> </table>	a	b	c	r	3.2	2	30	100	<p>2pcs.</p> <p>FN-2294</p>  <p>LN2294 (Front)</p> <table border="1" data-bbox="1089 1481 1385 1541"> <thead> <tr> <th>a</th> <th>b</th> <th>c</th> <th>r</th> </tr> </thead> <tbody> <tr> <td>6</td> <td>3.2</td> <td>75</td> <td>160</td> </tr> </tbody> </table>	a	b	c	r	6	3.2	75	160
a	b	c	r														
3.2	2	30	100														
a	b	c	r														
6	3.2	75	160														
<p>FN-2290</p>  <p>LN2290A (Rear)</p> <table border="1" data-bbox="417 1797 713 1858"> <thead> <tr> <th>a</th> <th>b</th> <th>c</th> <th>r</th> </tr> </thead> <tbody> <tr> <td>2.9</td> <td>2</td> <td>25</td> <td>90</td> </tr> </tbody> </table>	a	b	c	r	2.9	2	25	90	<p>2pcs.</p> <p>FN-2295</p>  <p>LN2295 (Rear)</p> <table border="1" data-bbox="1089 1797 1385 1858"> <thead> <tr> <th>a</th> <th>b</th> <th>c</th> <th>r</th> </tr> </thead> <tbody> <tr> <td>6</td> <td>3.2</td> <td>75</td> <td>160</td> </tr> </tbody> </table>	a	b	c	r	6	3.2	75	160
a	b	c	r														
2.9	2	25	90														
a	b	c	r														
6	3.2	75	160														
<p>LN2290</p>  <table border="1" data-bbox="417 2114 713 2175"> <thead> <tr> <th>a</th> <th>b</th> <th>c</th> <th>r</th> </tr> </thead> <tbody> <tr> <td>2.9</td> <td>2</td> <td>25</td> <td>90</td> </tr> </tbody> </table>	a	b	c	r	2.9	2	25	90	<p>2pcs.</p> <p>FN-2296</p>  <p>LN2296 (Front & Rear)</p> <table border="1" data-bbox="1089 2114 1385 2175"> <thead> <tr> <th>a</th> <th>b</th> <th>c</th> <th>r</th> </tr> </thead> <tbody> <tr> <td>4.5</td> <td>2.3</td> <td>75</td> <td>147.5</td> </tr> </tbody> </table>	a	b	c	r	4.5	2.3	75	147.5
a	b	c	r														
2.9	2	25	90														
a	b	c	r														
4.5	2.3	75	147.5														

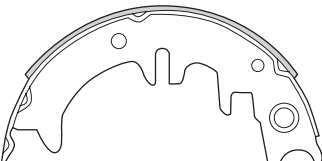

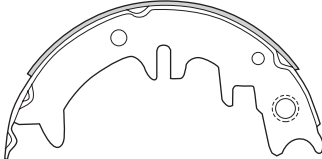
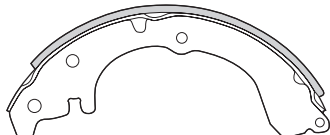
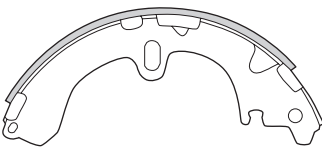
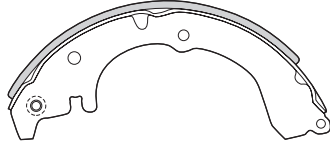
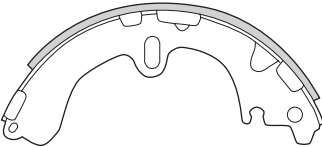
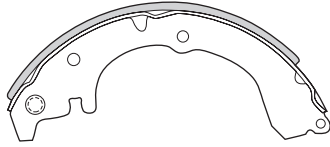
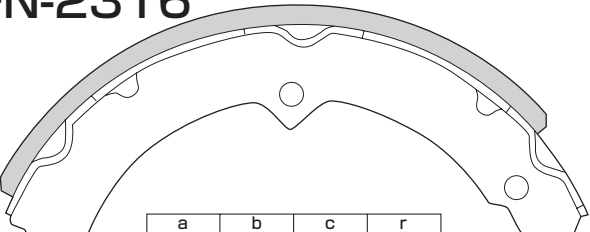

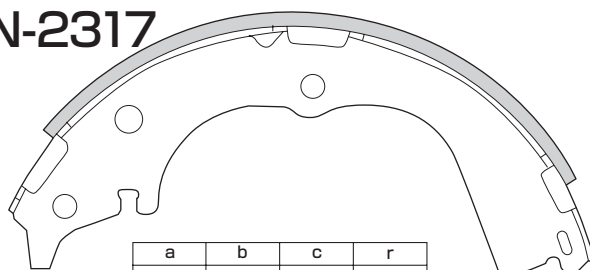
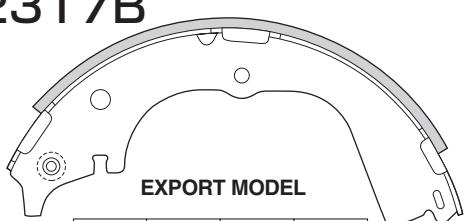
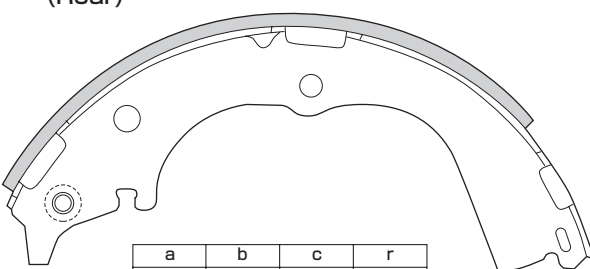
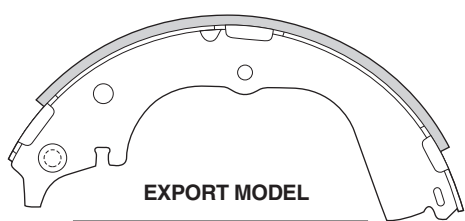
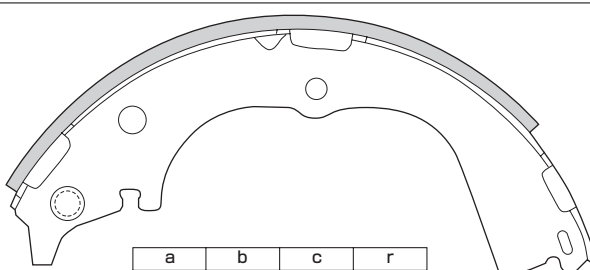
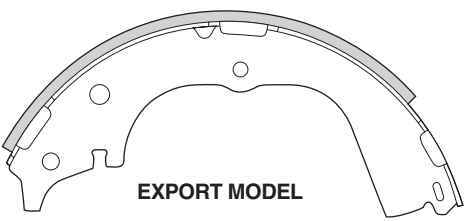
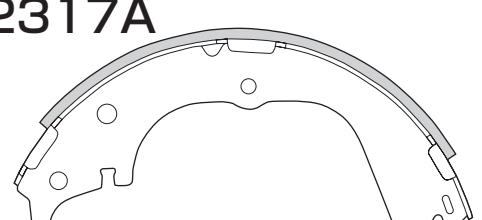
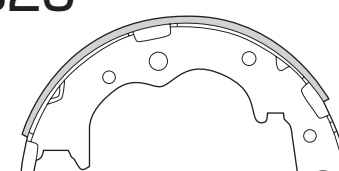
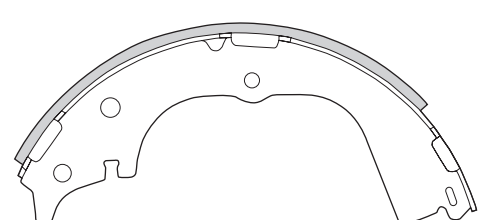

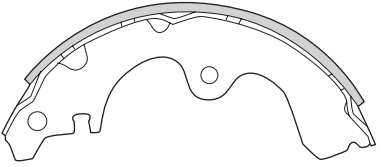
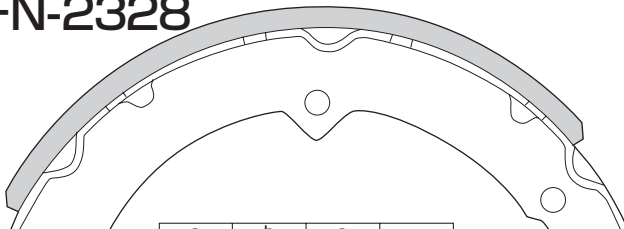
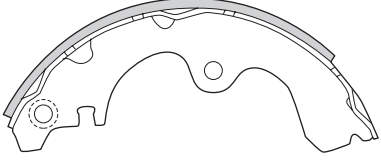
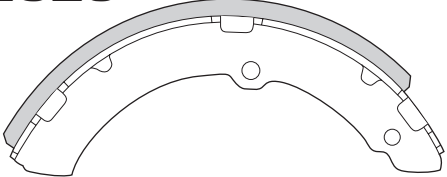
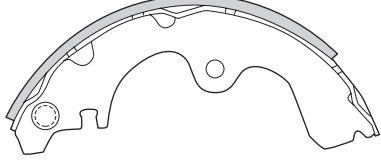
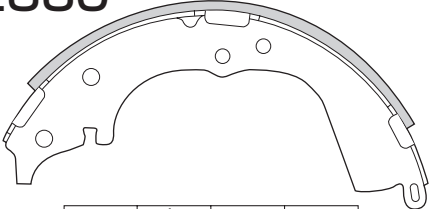
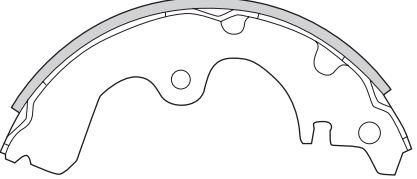
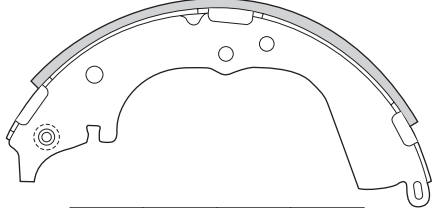
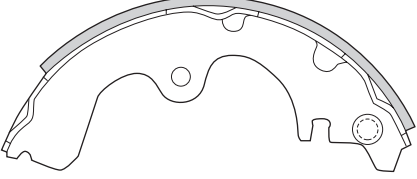
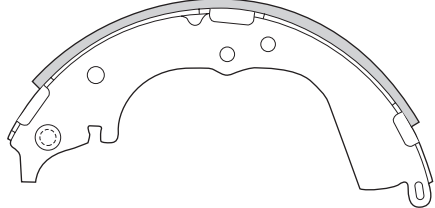
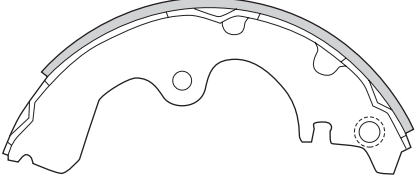
<p>FN-2297</p>  <p>LN2297 (Front & Rear)</p> <table border="1" data-bbox="421 531 716 584"> <thead> <tr> <th>a</th> <th>b</th> <th>c</th> <th>r</th> </tr> </thead> <tbody> <tr> <td>4.5</td> <td>3.2</td> <td>85</td> <td>130</td> </tr> </tbody> </table> <p>4pcs.</p>	a	b	c	r	4.5	3.2	85	130	<p>FN-2302</p>  <p>LN2302 (Rear)</p> <table border="1" data-bbox="1093 531 1388 584"> <thead> <tr> <th>a</th> <th>b</th> <th>c</th> <th>r</th> </tr> </thead> <tbody> <tr> <td>4.5</td> <td>2.3</td> <td>50</td> <td>147.5</td> </tr> </tbody> </table> <p>2pcs.</p>	a	b	c	r	4.5	2.3	50	147.5
a	b	c	r														
4.5	3.2	85	130														
a	b	c	r														
4.5	2.3	50	147.5														
<p>FN-2298</p>  <p>LN2298 (Parking)</p> <table border="1" data-bbox="421 847 716 901"> <thead> <tr> <th>a</th> <th>b</th> <th>c</th> <th>r</th> </tr> </thead> <tbody> <tr> <td>4.5</td> <td>2</td> <td>35</td> <td>80</td> </tr> </tbody> </table> <p>1pc.</p>	a	b	c	r	4.5	2	35	80	<p>LN2303</p>  <table border="1" data-bbox="1093 847 1388 901"> <thead> <tr> <th>a</th> <th>b</th> <th>c</th> <th>r</th> </tr> </thead> <tbody> <tr> <td>4.5</td> <td>2.3</td> <td>50</td> <td>147.5</td> </tr> </tbody> </table> <p>1pc.</p>	a	b	c	r	4.5	2.3	50	147.5
a	b	c	r														
4.5	2	35	80														
a	b	c	r														
4.5	2.3	50	147.5														
<p>LN2299</p>  <table border="1" data-bbox="421 1164 716 1218"> <thead> <tr> <th>a</th> <th>b</th> <th>c</th> <th>r</th> </tr> </thead> <tbody> <tr> <td>4.5</td> <td>2</td> <td>35</td> <td>80</td> </tr> </tbody> </table> <p>1pc.</p>	a	b	c	r	4.5	2	35	80	<p>LN2304</p>  <table border="1" data-bbox="1093 1164 1388 1218"> <thead> <tr> <th>a</th> <th>b</th> <th>c</th> <th>r</th> </tr> </thead> <tbody> <tr> <td>4.5</td> <td>2.3</td> <td>50</td> <td>147.5</td> </tr> </tbody> </table> <p>1pc.</p>	a	b	c	r	4.5	2.3	50	147.5
a	b	c	r														
4.5	2	35	80														
a	b	c	r														
4.5	2.3	50	147.5														
<p>FN-2300</p>  <p>DISCONTINUED</p> <p>LN2300(Rear)</p> <table border="1" data-bbox="421 1485 716 1539"> <thead> <tr> <th>a</th> <th>b</th> <th>c</th> <th>r</th> </tr> </thead> <tbody> <tr> <td>4.5</td> <td>2.3</td> <td>70</td> <td>122</td> </tr> </tbody> </table> <p>4pcs.</p>	a	b	c	r	4.5	2.3	70	122	<p>FN-2305</p>  <p>LN2305 (Rear)</p> <table border="1" data-bbox="1093 1485 1388 1539"> <thead> <tr> <th>a</th> <th>b</th> <th>c</th> <th>r</th> </tr> </thead> <tbody> <tr> <td>4.5</td> <td>2.3</td> <td>50</td> <td>147.5</td> </tr> </tbody> </table> <p>1pc.</p>	a	b	c	r	4.5	2.3	50	147.5
a	b	c	r														
4.5	2.3	70	122														
a	b	c	r														
4.5	2.3	50	147.5														
<p>FN-2301</p>  <p>EXPORT MODEL</p> <p>LN2301 (Front)</p> <table border="1" data-bbox="421 1814 716 1868"> <thead> <tr> <th>a</th> <th>b</th> <th>c</th> <th>r</th> </tr> </thead> <tbody> <tr> <td>4.5</td> <td>2.3</td> <td>75</td> <td>147.5</td> </tr> </tbody> </table> <p>4pcs.</p>	a	b	c	r	4.5	2.3	75	147.5	<p>LN2306</p>  <table border="1" data-bbox="1093 1814 1388 1868"> <thead> <tr> <th>a</th> <th>b</th> <th>c</th> <th>r</th> </tr> </thead> <tbody> <tr> <td>4.5</td> <td>2.3</td> <td>50</td> <td>147.5</td> </tr> </tbody> </table> <p>1pc.</p>	a	b	c	r	4.5	2.3	50	147.5
a	b	c	r														
4.5	2.3	75	147.5														
a	b	c	r														
4.5	2.3	50	147.5														
	<p>LN2307</p>  <table border="1" data-bbox="1093 2119 1388 2172"> <thead> <tr> <th>a</th> <th>b</th> <th>c</th> <th>r</th> </tr> </thead> <tbody> <tr> <td>4.5</td> <td>2.3</td> <td>50</td> <td>147.5</td> </tr> </tbody> </table> <p>2pcs.</p>	a	b	c	r	4.5	2.3	50	147.5								
a	b	c	r														
4.5	2.3	50	147.5														

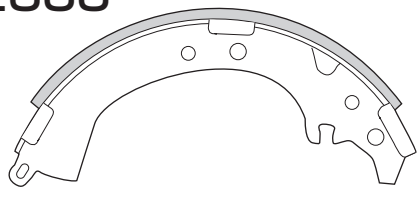
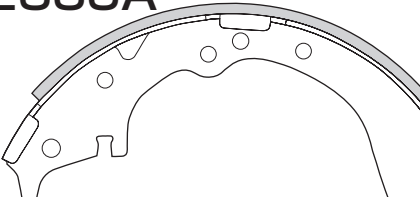
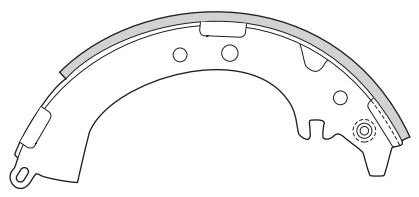
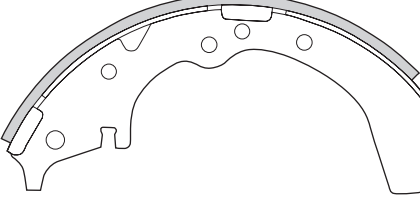
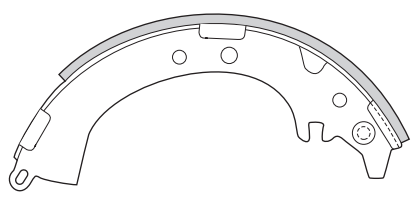
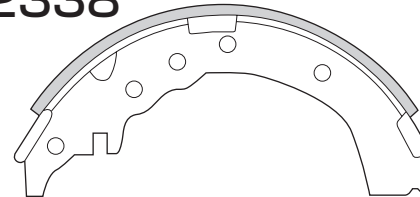
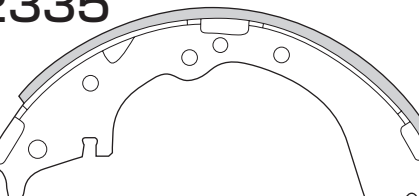
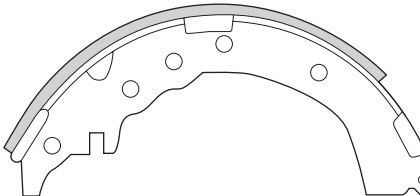
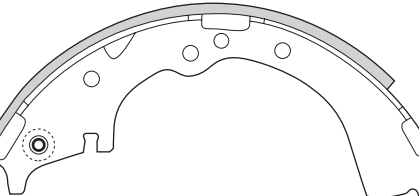
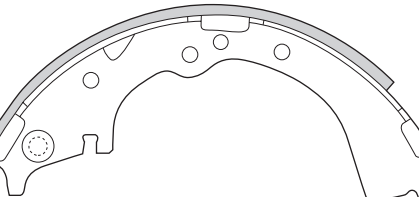

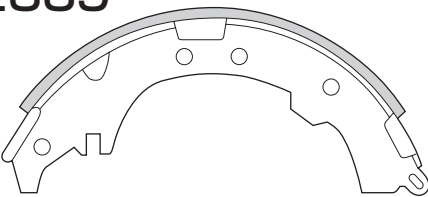
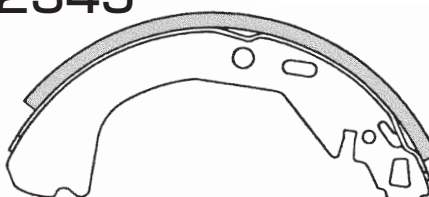
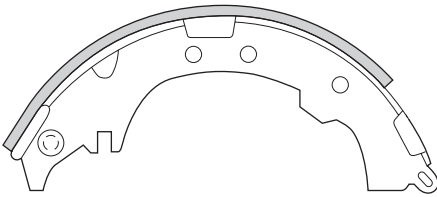

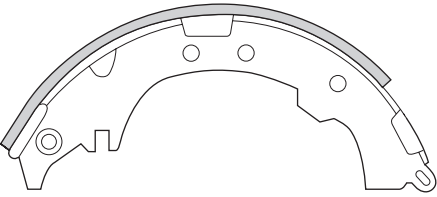
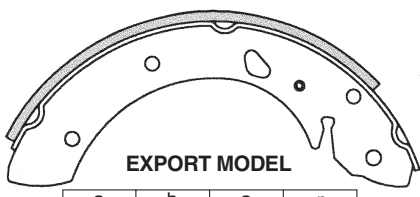
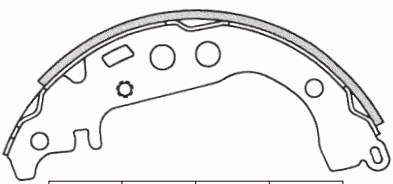

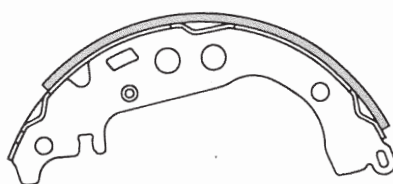

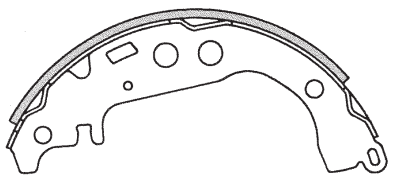
<h3>FN-2308</h3>  <p>LN2308 (Parking)</p> <table border="1" data-bbox="421 531 713 584"> <tr><th>a</th><th>b</th><th>c</th><th>r</th></tr> <tr><td>6</td><td>2</td><td>30</td><td>83.5</td></tr> </table> <p>2pcs.</p>	a	b	c	r	6	2	30	83.5	<h3>FN-2312</h3>  <p>EXPORT MODEL</p> <p>LN2312 (Rear)</p> <table border="1" data-bbox="1084 531 1376 584"> <tr><th>a</th><th>b</th><th>c</th><th>r</th></tr> <tr><td>4</td><td>2</td><td>40</td><td>114.3</td></tr> </table> <p>2pcs.</p>	a	b	c	r	4	2	40	114.3
a	b	c	r														
6	2	30	83.5														
a	b	c	r														
4	2	40	114.3														
 <p>LN2309</p> <table border="1" data-bbox="421 847 713 901"> <tr><th>a</th><th>b</th><th>c</th><th>r</th></tr> <tr><td>6</td><td>2</td><td>30</td><td>83.5</td></tr> </table> <p>1pc.</p>	a	b	c	r	6	2	30	83.5	 <p>EXPORT MODEL</p> <p>LN2312A</p> <table border="1" data-bbox="1084 847 1376 901"> <tr><th>a</th><th>b</th><th>c</th><th>r</th></tr> <tr><td>4</td><td>2</td><td>40</td><td>114.3</td></tr> </table> <p>2pcs.</p>	a	b	c	r	4	2	40	114.3
a	b	c	r														
6	2	30	83.5														
a	b	c	r														
4	2	40	114.3														
 <p>LN2310</p> <table border="1" data-bbox="421 1169 713 1222"> <tr><th>a</th><th>b</th><th>c</th><th>r</th></tr> <tr><td>6</td><td>2</td><td>30</td><td>83.5</td></tr> </table> <p>1pc.</p>	a	b	c	r	6	2	30	83.5	<h3>FN-2313</h3>  <p>LN2315 (Rear)</p> <table border="1" data-bbox="1084 1169 1376 1222"> <tr><th>a</th><th>b</th><th>c</th><th>r</th></tr> <tr><td>3.2</td><td>2</td><td>35</td><td>100</td></tr> </table> <p>2pcs.</p>	a	b	c	r	3.2	2	35	100
a	b	c	r														
6	2	30	83.5														
a	b	c	r														
3.2	2	35	100														
<h3>FN-2311</h3>  <p>LN2311 (Rear)</p> <table border="1" data-bbox="421 1490 713 1544"> <tr><th>a</th><th>b</th><th>c</th><th>r</th></tr> <tr><td>2.9</td><td>1.6</td><td>30</td><td>100</td></tr> </table> <p>2pcs.</p>	a	b	c	r	2.9	1.6	30	100	 <p>LN2313</p> <table border="1" data-bbox="1084 1490 1376 1544"> <tr><th>a</th><th>b</th><th>c</th><th>r</th></tr> <tr><td>3.2</td><td>2</td><td>35</td><td>100</td></tr> </table> <p>1pc.</p>	a	b	c	r	3.2	2	35	100
a	b	c	r														
2.9	1.6	30	100														
a	b	c	r														
3.2	2	35	100														
<p>LN2311A</p>  <table border="1" data-bbox="421 1807 713 1861"> <tr><th>a</th><th>b</th><th>c</th><th>r</th></tr> <tr><td>2.9</td><td>1.6</td><td>30</td><td>100</td></tr> </table> <p>2pcs.</p>	a	b	c	r	2.9	1.6	30	100	 <p>LN2314</p> <table border="1" data-bbox="1084 1807 1376 1861"> <tr><th>a</th><th>b</th><th>c</th><th>r</th></tr> <tr><td>3.2</td><td>2</td><td>35</td><td>100</td></tr> </table> <p>1pc.</p>	a	b	c	r	3.2	2	35	100
a	b	c	r														
2.9	1.6	30	100														
a	b	c	r														
3.2	2	35	100														
	<h3>FN-2316</h3>  <p>LN2316(Front)</p> <table border="1" data-bbox="1084 2131 1376 2185"> <tr><th>a</th><th>b</th><th>c</th><th>r</th></tr> <tr><td>6</td><td>3.2</td><td>75</td><td>160</td></tr> </table> <p>4pcs.</p>	a	b	c	r	6	3.2	75	160								
a	b	c	r														
6	3.2	75	160														

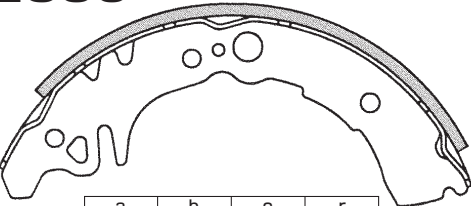
<p>FN-2317</p>  <p>LN2317 (Rear) 2pcs.</p> <table border="1" data-bbox="412 523 716 584"> <tr><th>a</th><th>b</th><th>c</th><th>r</th></tr> <tr><td>4.5</td><td>2.3</td><td>55</td><td>135</td></tr> </table>	a	b	c	r	4.5	2.3	55	135	<p>FN-2317B</p>  <p>EXPORT MODEL</p> <p>LN2318A (Rear) 1pc.</p> <table border="1" data-bbox="1093 523 1397 584"> <tr><th>a</th><th>b</th><th>c</th><th>r</th></tr> <tr><td>4.5</td><td>2.3</td><td>55</td><td>135</td></tr> </table>	a	b	c	r	4.5	2.3	55	135
a	b	c	r														
4.5	2.3	55	135														
a	b	c	r														
4.5	2.3	55	135														
 <p>LN2318 1pc.</p> <table border="1" data-bbox="412 840 716 901"> <tr><th>a</th><th>b</th><th>c</th><th>r</th></tr> <tr><td>4.5</td><td>2.3</td><td>55</td><td>135</td></tr> </table>	a	b	c	r	4.5	2.3	55	135	 <p>EXPORT MODEL</p> <p>LN2319A 1pc.</p> <table border="1" data-bbox="1093 840 1397 901"> <tr><th>a</th><th>b</th><th>c</th><th>r</th></tr> <tr><td>4.5</td><td>2.3</td><td>55</td><td>135</td></tr> </table>	a	b	c	r	4.5	2.3	55	135
a	b	c	r														
4.5	2.3	55	135														
a	b	c	r														
4.5	2.3	55	135														
 <p>LN2319 1pc.</p> <table border="1" data-bbox="412 1157 716 1218"> <tr><th>a</th><th>b</th><th>c</th><th>r</th></tr> <tr><td>4.5</td><td>2.3</td><td>55</td><td>135</td></tr> </table>	a	b	c	r	4.5	2.3	55	135	 <p>EXPORT MODEL</p> <p>LN2317A 2pcs.</p> <table border="1" data-bbox="1093 1157 1397 1218"> <tr><th>a</th><th>b</th><th>c</th><th>r</th></tr> <tr><td>4.5</td><td>2.3</td><td>55</td><td>135</td></tr> </table>	a	b	c	r	4.5	2.3	55	135
a	b	c	r														
4.5	2.3	55	135														
a	b	c	r														
4.5	2.3	55	135														
<p>FN-2317A</p>  <p>LN2317 (Rear) 2pcs.</p> <table border="1" data-bbox="412 1473 716 1534"> <tr><th>a</th><th>b</th><th>c</th><th>r</th></tr> <tr><td>4.5</td><td>2.3</td><td>55</td><td>135</td></tr> </table>	a	b	c	r	4.5	2.3	55	135	<p>FN-2320</p>  <p>LN2320 (Parking) 2pcs.</p> <table border="1" data-bbox="1093 1473 1397 1534"> <tr><th>a</th><th>b</th><th>c</th><th>r</th></tr> <tr><td>4.5</td><td>2</td><td>45</td><td>100</td></tr> </table>	a	b	c	r	4.5	2	45	100
a	b	c	r														
4.5	2.3	55	135														
a	b	c	r														
4.5	2	45	100														
 <p>LN2317A 2pcs.</p> <table border="1" data-bbox="412 1790 716 1851"> <tr><th>a</th><th>b</th><th>c</th><th>r</th></tr> <tr><td>4.5</td><td>2.3</td><td>55</td><td>135</td></tr> </table>	a	b	c	r	4.5	2.3	55	135									
a	b	c	r														
4.5	2.3	55	135														

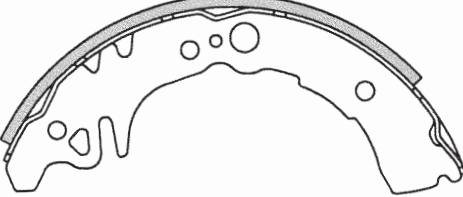
<p>FN-2321</p>  <p>LN2290A (Rear)</p> <table border="1" data-bbox="413 531 713 587"> <thead> <tr> <th>a</th> <th>b</th> <th>c</th> <th>r</th> </tr> </thead> <tbody> <tr> <td>2.9</td> <td>2</td> <td>25</td> <td>90</td> </tr> </tbody> </table>	a	b	c	r	2.9	2	25	90	<p>FN-2328</p>  <p>LN2328(Rear)</p> <table border="1" data-bbox="1089 531 1388 587"> <thead> <tr> <th>a</th> <th>b</th> <th>c</th> <th>r</th> </tr> </thead> <tbody> <tr> <td>6</td> <td>3.2</td> <td>75</td> <td>160</td> </tr> </tbody> </table>	a	b	c	r	6	3.2	75	160
a	b	c	r														
2.9	2	25	90														
a	b	c	r														
6	3.2	75	160														
<p>FN-2321</p>  <p>LN2321</p> <table border="1" data-bbox="413 852 713 908"> <thead> <tr> <th>a</th> <th>b</th> <th>c</th> <th>r</th> </tr> </thead> <tbody> <tr> <td>2.9</td> <td>2</td> <td>25</td> <td>90</td> </tr> </tbody> </table>	a	b	c	r	2.9	2	25	90	<p>FN-2329</p>  <p>LN2329(F&R)</p> <table border="1" data-bbox="1089 852 1388 908"> <thead> <tr> <th>a</th> <th>b</th> <th>c</th> <th>r</th> </tr> </thead> <tbody> <tr> <td>6</td> <td>3.2</td> <td>83</td> <td>160</td> </tr> </tbody> </table>	a	b	c	r	6	3.2	83	160
a	b	c	r														
2.9	2	25	90														
a	b	c	r														
6	3.2	83	160														
<p>FN-2322</p>  <p>LN2322</p> <table border="1" data-bbox="413 1169 713 1225"> <thead> <tr> <th>a</th> <th>b</th> <th>c</th> <th>r</th> </tr> </thead> <tbody> <tr> <td>2.9</td> <td>2</td> <td>25</td> <td>90</td> </tr> </tbody> </table>	a	b	c	r	2.9	2	25	90	<p>FN-2330</p>  <p>LN2330 (Rear)</p> <table border="1" data-bbox="1089 1169 1388 1225"> <thead> <tr> <th>a</th> <th>b</th> <th>c</th> <th>r</th> </tr> </thead> <tbody> <tr> <td>4.5</td> <td>2.3</td> <td>55</td> <td>135</td> </tr> </tbody> </table>	a	b	c	r	4.5	2.3	55	135
a	b	c	r														
2.9	2	25	90														
a	b	c	r														
4.5	2.3	55	135														
<p>FN-2326</p>  <p>LN2287 (Rear)</p> <table border="1" data-bbox="413 1498 713 1554"> <thead> <tr> <th>a</th> <th>b</th> <th>c</th> <th>r</th> </tr> </thead> <tbody> <tr> <td>2.9</td> <td>2</td> <td>30</td> <td>90</td> </tr> </tbody> </table>	a	b	c	r	2.9	2	30	90	<p>FN-2331</p>  <p>LN2331</p> <table border="1" data-bbox="1089 1498 1388 1554"> <thead> <tr> <th>a</th> <th>b</th> <th>c</th> <th>r</th> </tr> </thead> <tbody> <tr> <td>4.5</td> <td>2.3</td> <td>55</td> <td>135</td> </tr> </tbody> </table>	a	b	c	r	4.5	2.3	55	135
a	b	c	r														
2.9	2	30	90														
a	b	c	r														
4.5	2.3	55	135														
<p>FN-2326</p>  <p>LN2326</p> <table border="1" data-bbox="413 1814 713 1870"> <thead> <tr> <th>a</th> <th>b</th> <th>c</th> <th>r</th> </tr> </thead> <tbody> <tr> <td>2.9</td> <td>2</td> <td>30</td> <td>90</td> </tr> </tbody> </table>	a	b	c	r	2.9	2	30	90	<p>FN-2332</p>  <p>LN2332</p> <table border="1" data-bbox="1089 1814 1388 1870"> <thead> <tr> <th>a</th> <th>b</th> <th>c</th> <th>r</th> </tr> </thead> <tbody> <tr> <td>4.5</td> <td>2.3</td> <td>55</td> <td>135</td> </tr> </tbody> </table>	a	b	c	r	4.5	2.3	55	135
a	b	c	r														
2.9	2	30	90														
a	b	c	r														
4.5	2.3	55	135														
<p>FN-2327</p>  <p>LN2327</p> <table border="1" data-bbox="413 2131 713 2187"> <thead> <tr> <th>a</th> <th>b</th> <th>c</th> <th>r</th> </tr> </thead> <tbody> <tr> <td>2.9</td> <td>2</td> <td>30</td> <td>90</td> </tr> </tbody> </table>	a	b	c	r	2.9	2	30	90									
a	b	c	r														
2.9	2	30	90														

<p>FN-2333</p>  <p>LN2312 (Rear) 2pcs.</p> <table border="1" data-bbox="412 523 707 584"> <tr><th>a</th><th>b</th><th>c</th><th>r</th></tr> <tr><td>4.0</td><td>2.0</td><td>40</td><td>114.3</td></tr> </table>	a	b	c	r	4.0	2.0	40	114.3	<p>FN-2335A</p>  <p>LN2335 (Rear) 2pcs.</p> <table border="1" data-bbox="1084 523 1379 584"> <tr><th>a</th><th>b</th><th>c</th><th>r</th></tr> <tr><td>4.5</td><td>2.3</td><td>50</td><td>127</td></tr> </table>	a	b	c	r	4.5	2.3	50	127
a	b	c	r														
4.0	2.0	40	114.3														
a	b	c	r														
4.5	2.3	50	127														
 <p>LN2333 1pc.</p> <table border="1" data-bbox="412 840 707 901"> <tr><th>a</th><th>b</th><th>c</th><th>r</th></tr> <tr><td>4.0</td><td>2.0</td><td>40</td><td>114.3</td></tr> </table>	a	b	c	r	4.0	2.0	40	114.3	 <p>LN2335A 2pcs.</p> <table border="1" data-bbox="1084 840 1379 901"> <tr><th>a</th><th>b</th><th>c</th><th>r</th></tr> <tr><td>4.5</td><td>2.3</td><td>50</td><td>127</td></tr> </table>	a	b	c	r	4.5	2.3	50	127
a	b	c	r														
4.0	2.0	40	114.3														
a	b	c	r														
4.5	2.3	50	127														
 <p>LN2334 1pc.</p> <table border="1" data-bbox="412 1157 707 1218"> <tr><th>a</th><th>b</th><th>c</th><th>r</th></tr> <tr><td>4.0</td><td>2.0</td><td>40</td><td>114.3</td></tr> </table>	a	b	c	r	4.0	2.0	40	114.3	<p>FN-2338</p>  <p>LN2338 (Rear) 2pcs.</p> <table border="1" data-bbox="1084 1157 1379 1218"> <tr><th>a</th><th>b</th><th>c</th><th>r</th></tr> <tr><td>4.0</td><td>2.0</td><td>35</td><td>114.3</td></tr> </table>	a	b	c	r	4.0	2.0	35	114.3
a	b	c	r														
4.0	2.0	40	114.3														
a	b	c	r														
4.0	2.0	35	114.3														
<p>FN-2335</p>  <p>LN2335 (Rear) 2pcs.</p> <table border="1" data-bbox="412 1473 707 1534"> <tr><th>a</th><th>b</th><th>c</th><th>r</th></tr> <tr><td>4.5</td><td>2.3</td><td>50</td><td>127</td></tr> </table>	a	b	c	r	4.5	2.3	50	127	 <p>LN2338A 2pcs.</p> <table border="1" data-bbox="1084 1473 1379 1534"> <tr><th>a</th><th>b</th><th>c</th><th>r</th></tr> <tr><td>4.0</td><td>2.0</td><td>35</td><td>114.3</td></tr> </table>	a	b	c	r	4.0	2.0	35	114.3
a	b	c	r														
4.5	2.3	50	127														
a	b	c	r														
4.0	2.0	35	114.3														
 <p>LN2336 1pc.</p> <table border="1" data-bbox="412 1790 707 1851"> <tr><th>a</th><th>b</th><th>c</th><th>r</th></tr> <tr><td>4.5</td><td>2.3</td><td>50</td><td>127</td></tr> </table>	a	b	c	r	4.5	2.3	50	127									
a	b	c	r														
4.5	2.3	50	127														
 <p>LN2337 1pc.</p> <table border="1" data-bbox="412 2107 707 2168"> <tr><th>a</th><th>b</th><th>c</th><th>r</th></tr> <tr><td>4.5</td><td>2.3</td><td>50</td><td>127</td></tr> </table>	a	b	c	r	4.5	2.3	50	127									
a	b	c	r														
4.5	2.3	50	127														

<p>FN-2339</p>  <p>LN2339 (Rear)</p> <table border="1" data-bbox="412 531 713 584"> <thead> <tr> <th>a</th> <th>b</th> <th>c</th> <th>r</th> </tr> </thead> <tbody> <tr> <td>4.0</td> <td>2.0</td> <td>40</td> <td>114.3</td> </tr> </tbody> </table> <p>2pc.</p>	a	b	c	r	4.0	2.0	40	114.3	<p>FN-2345</p>  <p>LN2345(Rear)</p> <table border="1" data-bbox="1084 531 1385 584"> <thead> <tr> <th>a</th> <th>b</th> <th>c</th> <th>r</th> </tr> </thead> <tbody> <tr> <td>4</td> <td>2</td> <td>45</td> <td>112.5</td> </tr> </tbody> </table> <p>4pcs.</p>	a	b	c	r	4	2	45	112.5
a	b	c	r														
4.0	2.0	40	114.3														
a	b	c	r														
4	2	45	112.5														
 <p>LN2340</p> <table border="1" data-bbox="412 847 713 901"> <thead> <tr> <th>a</th> <th>b</th> <th>c</th> <th>r</th> </tr> </thead> <tbody> <tr> <td>4.0</td> <td>2.0</td> <td>40</td> <td>114.3</td> </tr> </tbody> </table> <p>1pc.</p>	a	b	c	r	4.0	2.0	40	114.3	<p>FN-2345</p>  <p>LN2345(Rear)</p> <table border="1" data-bbox="1084 847 1385 901"> <thead> <tr> <th>a</th> <th>b</th> <th>c</th> <th>r</th> </tr> </thead> <tbody> <tr> <td>4.0</td> <td>2.0</td> <td>45</td> <td>112.5</td> </tr> </tbody> </table>	a	b	c	r	4.0	2.0	45	112.5
a	b	c	r														
4.0	2.0	40	114.3														
a	b	c	r														
4.0	2.0	45	112.5														
 <p>LN2341</p> <table border="1" data-bbox="412 1164 713 1218"> <thead> <tr> <th>a</th> <th>b</th> <th>c</th> <th>r</th> </tr> </thead> <tbody> <tr> <td>4.0</td> <td>2.0</td> <td>40</td> <td>114.3</td> </tr> </tbody> </table> <p>1pc.</p>	a	b	c	r	4.0	2.0	40	114.3	<p>FN-2347</p>  <p>LN2347 (Rear)</p> <table border="1" data-bbox="1084 1169 1385 1222"> <thead> <tr> <th>a</th> <th>b</th> <th>c</th> <th>r</th> </tr> </thead> <tbody> <tr> <td>3.2</td> <td>2.3</td> <td>35</td> <td>114.3</td> </tr> </tbody> </table> <p>2pcs.</p>	a	b	c	r	3.2	2.3	35	114.3
a	b	c	r														
4.0	2.0	40	114.3														
a	b	c	r														
3.2	2.3	35	114.3														
<p>FN-2342</p>  <p>LN2342 (Rear)</p> <table border="1" data-bbox="412 1485 713 1539"> <thead> <tr> <th>a</th> <th>b</th> <th>c</th> <th>r</th> </tr> </thead> <tbody> <tr> <td>2.9</td> <td>2</td> <td>30</td> <td>100</td> </tr> </tbody> </table> <p>1pc.</p>	a	b	c	r	2.9	2	30	100	<p>EXPORT MODEL</p>  <p>LN2348</p> <table border="1" data-bbox="1084 1485 1385 1539"> <thead> <tr> <th>a</th> <th>b</th> <th>c</th> <th>r</th> </tr> </thead> <tbody> <tr> <td>3.2</td> <td>2.3</td> <td>35</td> <td>114.3</td> </tr> </tbody> </table> <p>1pc.</p>	a	b	c	r	3.2	2.3	35	114.3
a	b	c	r														
2.9	2	30	100														
a	b	c	r														
3.2	2.3	35	114.3														
 <p>LN2343</p> <table border="1" data-bbox="412 1802 713 1856"> <thead> <tr> <th>a</th> <th>b</th> <th>c</th> <th>r</th> </tr> </thead> <tbody> <tr> <td>2.9</td> <td>2</td> <td>30</td> <td>100</td> </tr> </tbody> </table> <p>1pc.</p>	a	b	c	r	2.9	2	30	100	<p>EXPORT MODEL</p>  <p>LN2349</p> <table border="1" data-bbox="1084 1802 1385 1856"> <thead> <tr> <th>a</th> <th>b</th> <th>c</th> <th>r</th> </tr> </thead> <tbody> <tr> <td>3.2</td> <td>2.3</td> <td>35</td> <td>114.3</td> </tr> </tbody> </table> <p>1pc.</p>	a	b	c	r	3.2	2.3	35	114.3
a	b	c	r														
2.9	2	30	100														
a	b	c	r														
3.2	2.3	35	114.3														
 <p>LN2344</p> <table border="1" data-bbox="412 2119 713 2172"> <thead> <tr> <th>a</th> <th>b</th> <th>c</th> <th>r</th> </tr> </thead> <tbody> <tr> <td>2.9</td> <td>2</td> <td>30</td> <td>100</td> </tr> </tbody> </table> <p>2pcs.</p>	a	b	c	r	2.9	2	30	100									
a	b	c	r														
2.9	2	30	100														

<h3>FN-2350</h3>  <p>LN2350 (Rear)</p> <table border="1" data-bbox="419 531 716 584"> <tr><th>a</th><th>b</th><th>c</th><th>r</th></tr> <tr><td>2.9</td><td>1.6</td><td>25</td><td>90</td></tr> </table> <p>2pcs.</p>	a	b	c	r	2.9	1.6	25	90	<h3>FN-2354</h3>  <p>EXPORT MODEL</p> <p>LN2354 (Rear)</p> <table border="1" data-bbox="1089 531 1387 584"> <tr><th>a</th><th>b</th><th>c</th><th>r</th></tr> <tr><td>3.5</td><td>2.0</td><td>35</td><td>100</td></tr> </table> <p>2pcs.</p>	a	b	c	r	3.5	2.0	35	100
a	b	c	r														
2.9	1.6	25	90														
a	b	c	r														
3.5	2.0	35	100														
 <p>LN2350A</p> <table border="1" data-bbox="419 847 716 901"> <tr><th>a</th><th>b</th><th>c</th><th>r</th></tr> <tr><td>2.9</td><td>1.6</td><td>25</td><td>90</td></tr> </table> <p>2pcs.</p>	a	b	c	r	2.9	1.6	25	90	 <p>EXPORT MODEL</p> <p>LN2355</p> <table border="1" data-bbox="1089 847 1387 901"> <tr><th>a</th><th>b</th><th>c</th><th>r</th></tr> <tr><td>3.5</td><td>2.0</td><td>35</td><td>100</td></tr> </table> <p>1pc.</p>	a	b	c	r	3.5	2.0	35	100
a	b	c	r														
2.9	1.6	25	90														
a	b	c	r														
3.5	2.0	35	100														
<h3>FN-2351</h3>  <p>DISCONTINUED</p> <p>LN2289 (Rear)</p> <table border="1" data-bbox="419 1174 716 1227"> <tr><th>a</th><th>b</th><th>c</th><th>r</th></tr> <tr><td>3.2</td><td>2</td><td>30</td><td>100</td></tr> </table> <p>2pcs.</p>	a	b	c	r	3.2	2	30	100	 <p>EXPORT MODEL</p> <p>LN2356</p> <table border="1" data-bbox="1089 1174 1387 1227"> <tr><th>a</th><th>b</th><th>c</th><th>r</th></tr> <tr><td>3.5</td><td>2.0</td><td>35</td><td>100</td></tr> </table> <p>1pc.</p>	a	b	c	r	3.5	2.0	35	100
a	b	c	r														
3.2	2	30	100														
a	b	c	r														
3.5	2.0	35	100														
 <p>DISCONTINUED</p> <p>LN2351</p> <table border="1" data-bbox="419 1490 716 1544"> <tr><th>a</th><th>b</th><th>c</th><th>r</th></tr> <tr><td>3.2</td><td>2</td><td>30</td><td>100</td></tr> </table> <p>1pc.</p>	a	b	c	r	3.2	2	30	100									
a	b	c	r														
3.2	2	30	100														
 <p>DISCONTINUED</p> <p>LN2352</p> <table border="1" data-bbox="419 1817 716 1870"> <tr><th>a</th><th>b</th><th>c</th><th>r</th></tr> <tr><td>3.2</td><td>2</td><td>30</td><td>100</td></tr> </table> <p>1pc.</p>	a	b	c	r	3.2	2	30	100									
a	b	c	r														
3.2	2	30	100														

FN-2358

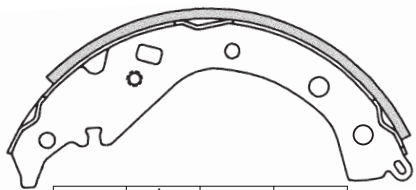

LN2358

(Rear)

a	b	c	r
4	2	35	114.3

1 pc.

FN-2363

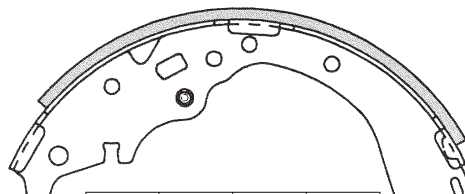

LN2363

(Rear)

a	b	c	r
4.5	2.3	50	127

1 pc.

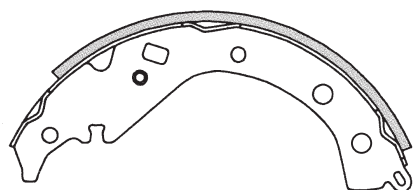

LN2359

a	b	c	r
4	2	35	114.3

1 pc.

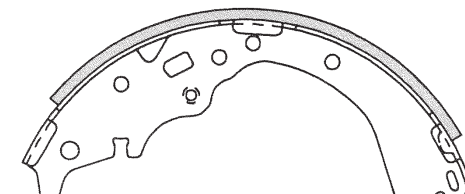

LN2364

a	b	c	r
4.5	2.3	50	127

1 pc.

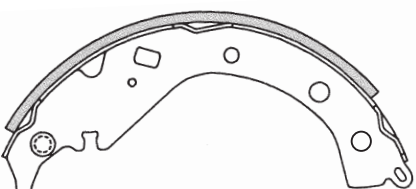

LN2360

a	b	c	r
4	2	35	114.3

1 pc.

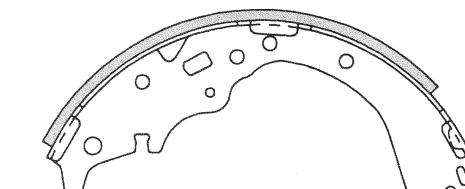

LN2365

a	b	c	r
4.5	2.3	50	127

2 pcs.

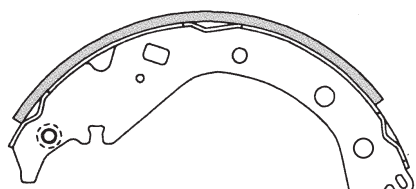

LN2361

a	b	c	r
4	2	35	114.3

1 pc.

FN-2366

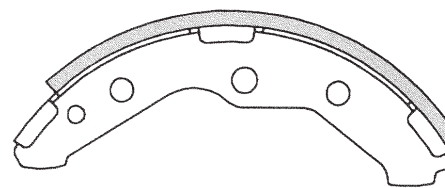

LN2366(Rear)

a	b	c	r
4.5	2.3	70	122

4 pcs.

FN-2362

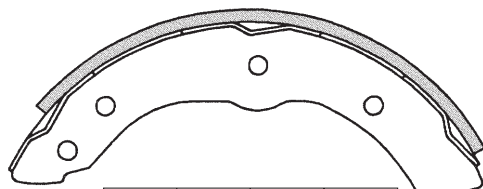

LN2362(Rear)

a	b	c	r
4.5	2.3	60	145

4 pcs.

FN-2367

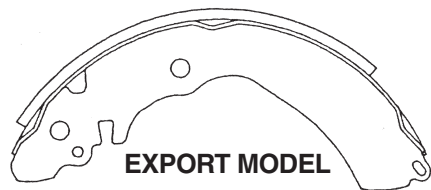

EXPORT MODEL

a	b	c	r
2.9	1.6	35	101.6

LN2367
(Rear)

2pc.

FN-2371

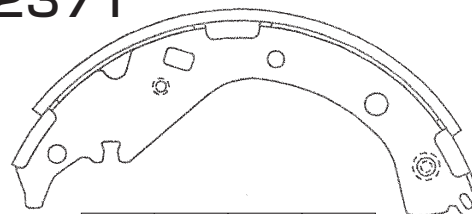

a	b	c	r
4	2	40	114.3

LN2371
(Rear)

1pc.

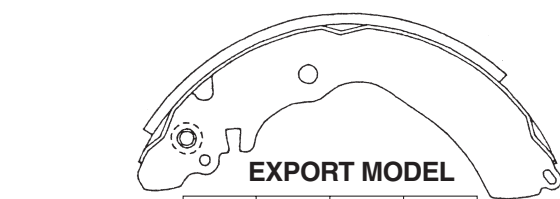

EXPORT MODEL

a	b	c	r
2.9	1.6	35	101.6

LN2368

1pc.

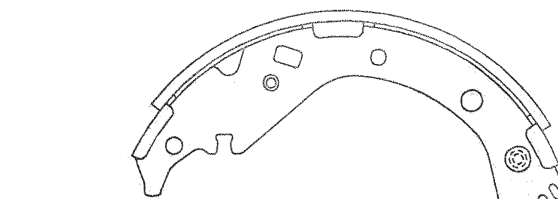

a	b	c	r
4	2	40	114.3

LN2372

1pc.



EXPORT MODEL

a	b	c	r
2.9	1.6	35	101.6

LN2369

1pc.

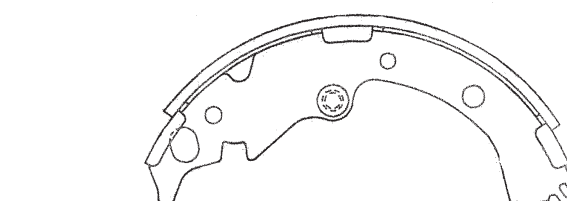

a	b	c	r
4	2	40	114.3

LN2374
(Rear)

1pc.

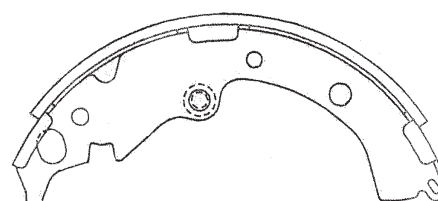

a	b	c	r
4	2	40	114.3

LN2375

1pc.

FN-2378

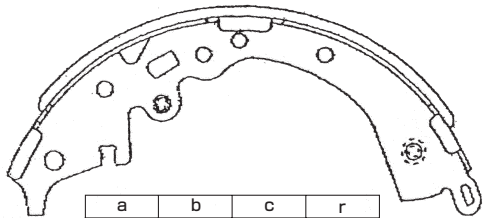

LN2378
(Rear)

a	b	c	r
4.5	2.3	50	127

1 pcs.

FN-2383

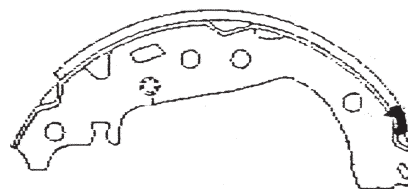

LN2383

a	b	c	r
2.9	1.6	30	100

1 pc.

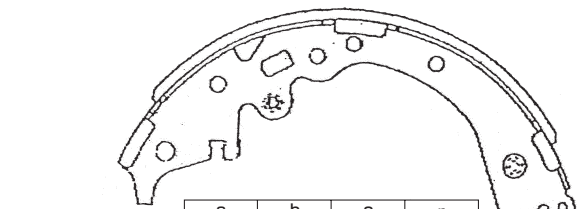

LN2379

a	b	c	r
4.5	2.3	50	127

1 pcs.

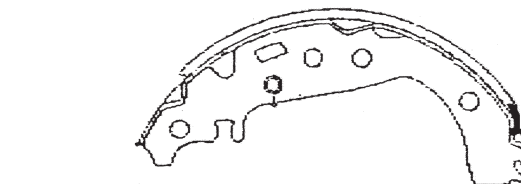

LN2384

a	b	c	r
2.9	1.6	30	100

1 pc.

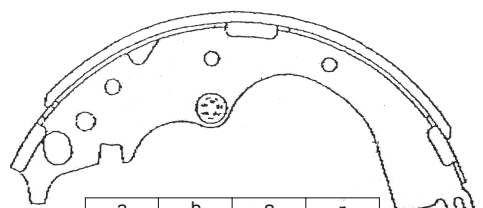

LN2381
(Rear)

a	b	c	r
4.5	2.3	50	127

1 pcs.

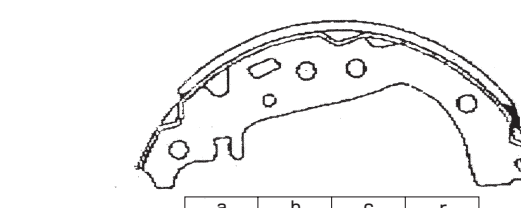

LN2385

a	b	c	r
2.9	1.6	30	100

2 pcs.

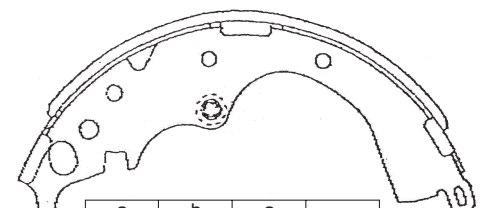

LN2382

a	b	c	r
4.5	2.3	50	127

1 pcs.

FN-2386

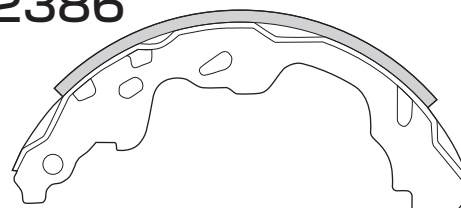

LN2386
(Rear)

a	b	c	r
2.9	2	30	100

2 pcs.

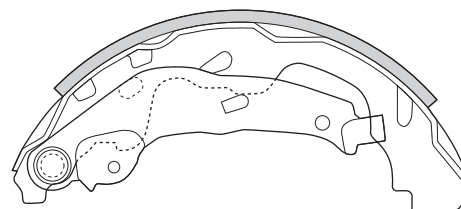

LN2387

a	b	c	r
2.9	2	30	100

1 pc.

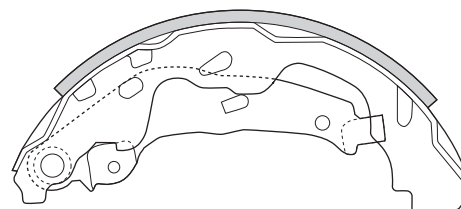

LN2388

a	b	c	r
2.9	2	30	100

1 pc.

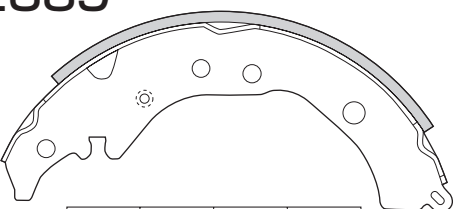
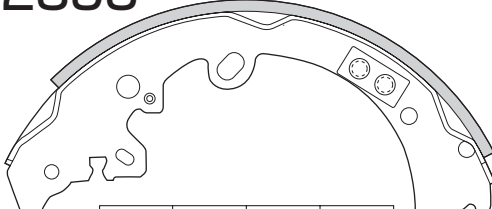
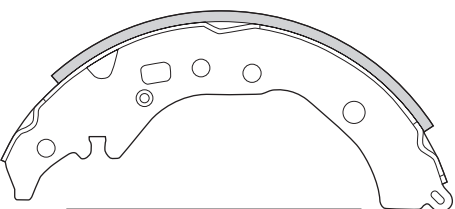
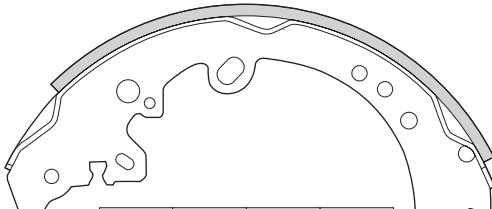
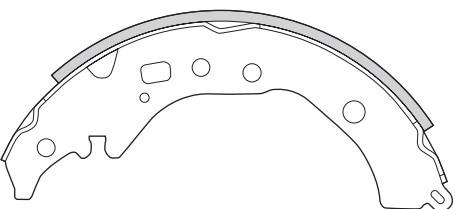
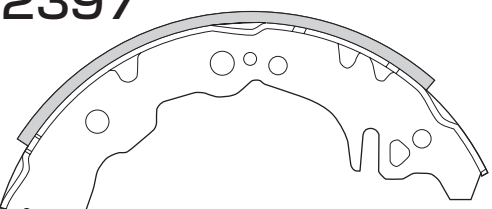
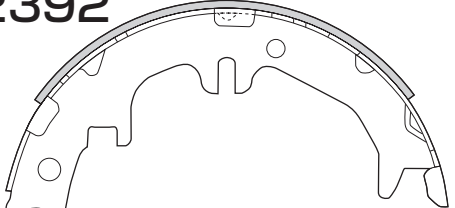
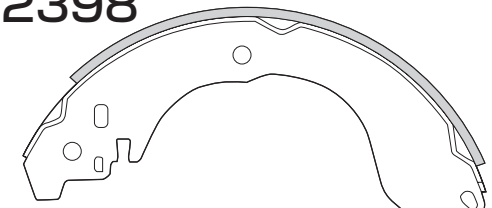
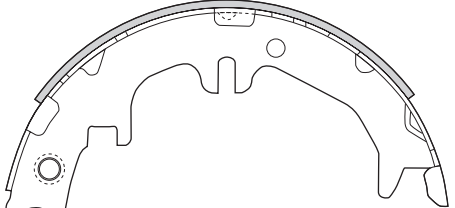
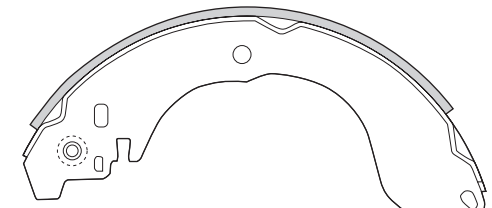
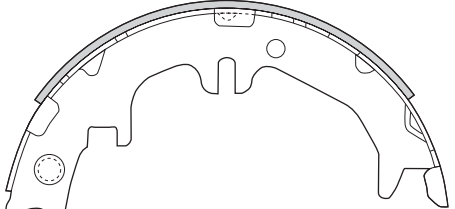
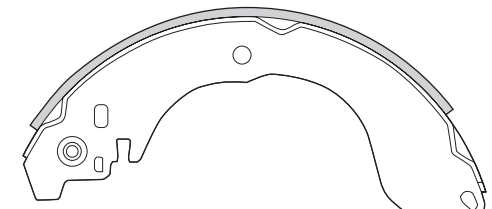
<p>FN-2389</p>  <p>LN2389 (Rear) 1pc.</p> <table border="1" data-bbox="412 523 707 584"> <tr><th>a</th><th>b</th><th>c</th><th>r</th></tr> <tr><td>4.0</td><td>2</td><td>35</td><td>114.3</td></tr> </table>	a	b	c	r	4.0	2	35	114.3	<p>FN-2395</p>  <p>LN2395 (Rear) 2pcs.</p> <table border="1" data-bbox="1084 523 1379 584"> <tr><th>a</th><th>b</th><th>c</th><th>r</th></tr> <tr><td>4.5</td><td>2.6</td><td>50</td><td>147.5</td></tr> </table>	a	b	c	r	4.5	2.6	50	147.5
a	b	c	r														
4.0	2	35	114.3														
a	b	c	r														
4.5	2.6	50	147.5														
 <p>LN2390 1pc.</p> <table border="1" data-bbox="412 840 707 901"> <tr><th>a</th><th>b</th><th>c</th><th>r</th></tr> <tr><td>4.0</td><td>2</td><td>35</td><td>114.3</td></tr> </table>	a	b	c	r	4.0	2	35	114.3	 <p>LN2396 2pcs.</p> <table border="1" data-bbox="1084 840 1379 901"> <tr><th>a</th><th>b</th><th>c</th><th>r</th></tr> <tr><td>4.5</td><td>2.6</td><td>50</td><td>147.5</td></tr> </table>	a	b	c	r	4.5	2.6	50	147.5
a	b	c	r														
4.0	2	35	114.3														
a	b	c	r														
4.5	2.6	50	147.5														
 <p>LN2391 2pcs.</p> <table border="1" data-bbox="412 1157 707 1218"> <tr><th>a</th><th>b</th><th>c</th><th>r</th></tr> <tr><td>4.0</td><td>2</td><td>35</td><td>114.3</td></tr> </table>	a	b	c	r	4.0	2	35	114.3	<p>FN-2397</p>  <p>LN2397(Rear) 4pcs.</p> <table border="1" data-bbox="1084 1157 1379 1218"> <tr><th>a</th><th>b</th><th>c</th><th>r</th></tr> <tr><td>2.9</td><td>2.0</td><td>25</td><td>90</td></tr> </table>	a	b	c	r	2.9	2.0	25	90
a	b	c	r														
4.0	2	35	114.3														
a	b	c	r														
2.9	2.0	25	90														
<p>FN-2392</p>  <p>LN2392 (Rear) 2pcs.</p> <table border="1" data-bbox="412 1473 707 1534"> <tr><th>a</th><th>b</th><th>c</th><th>r</th></tr> <tr><td>6</td><td>2</td><td>25</td><td>95</td></tr> </table>	a	b	c	r	6	2	25	95	<p>FN-2398</p>  <p>LN2398 (Rear) 2pcs.</p> <table border="1" data-bbox="1084 1473 1379 1534"> <tr><th>a</th><th>b</th><th>c</th><th>r</th></tr> <tr><td>3.2</td><td>2</td><td>40</td><td>114.3</td></tr> </table>	a	b	c	r	3.2	2	40	114.3
a	b	c	r														
6	2	25	95														
a	b	c	r														
3.2	2	40	114.3														
 <p>LN2393 1pc.</p> <table border="1" data-bbox="412 1790 707 1851"> <tr><th>a</th><th>b</th><th>c</th><th>r</th></tr> <tr><td>6</td><td>2</td><td>25</td><td>95</td></tr> </table>	a	b	c	r	6	2	25	95	 <p>LN2399 1pc.</p> <table border="1" data-bbox="1084 1790 1379 1851"> <tr><th>a</th><th>b</th><th>c</th><th>r</th></tr> <tr><td>3.2</td><td>2</td><td>40</td><td>114.3</td></tr> </table>	a	b	c	r	3.2	2	40	114.3
a	b	c	r														
6	2	25	95														
a	b	c	r														
3.2	2	40	114.3														
 <p>LN2394 1pc.</p> <table border="1" data-bbox="412 2107 707 2168"> <tr><th>a</th><th>b</th><th>c</th><th>r</th></tr> <tr><td>6</td><td>2</td><td>25</td><td>95</td></tr> </table>	a	b	c	r	6	2	25	95	 <p>LN2400 1pc.</p> <table border="1" data-bbox="1084 2107 1379 2168"> <tr><th>a</th><th>b</th><th>c</th><th>r</th></tr> <tr><td>3.2</td><td>2</td><td>40</td><td>114.3</td></tr> </table>	a	b	c	r	3.2	2	40	114.3
a	b	c	r														
6	2	25	95														
a	b	c	r														
3.2	2	40	114.3														

FN-2401

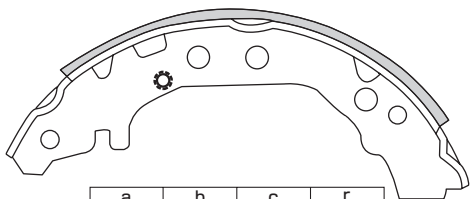

LN2401
(Rear)

a	b	c	r
2.9	1.6	24.5	90

1 pcs.

FN-2404

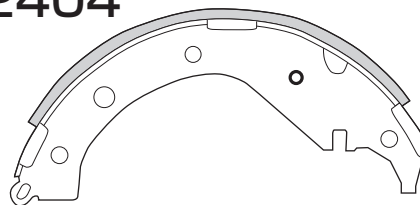

LN2404
(Rear)

a	b	c	r
4	2	35	114.3

1 pc.

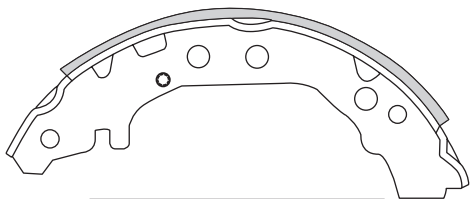

LN2402

a	b	c	r
2.9	1.6	24.5	90

1 pcs.

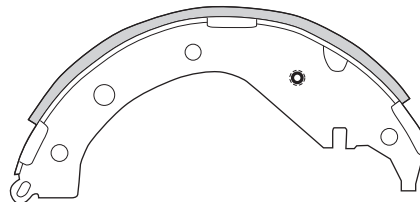

LN2405

a	b	c	r
4	2	35	114.3

1 pc.

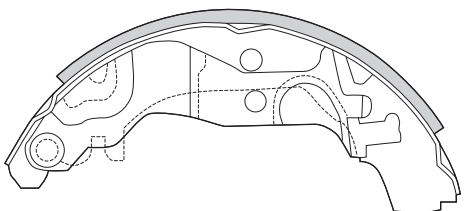

LN2403

a	b	c	r
2.9	1.6	24.5	90

1 pcs.

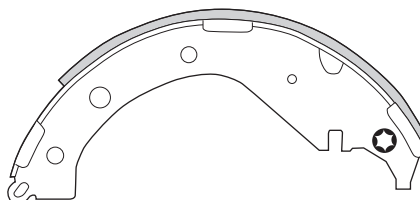

LN2406

a	b	c	r
4	2	35	114.3

1 pc.

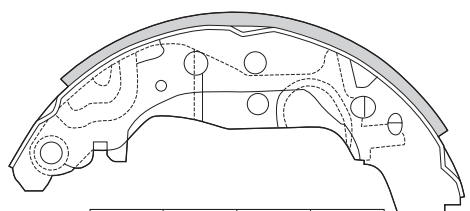

LN2404

a	b	c	r
2.9	1.6	24.5	90

1 pcs.

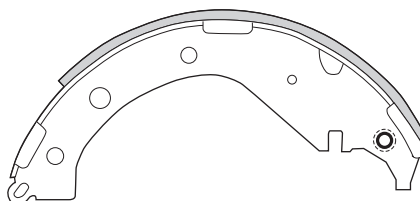

LN2407

a	b	c	r
4	2	35	114.3

1 pc.

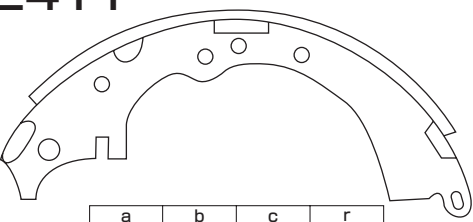
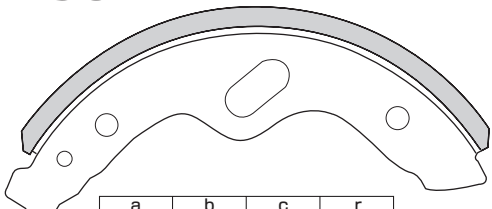
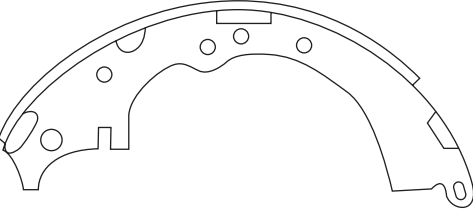
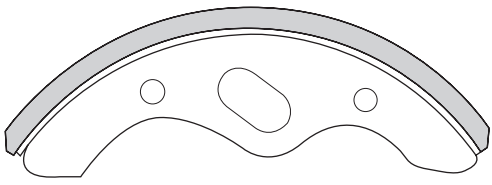
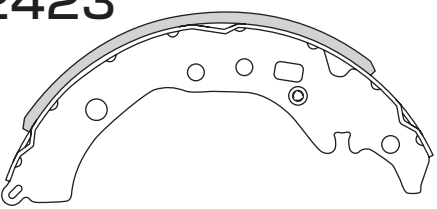
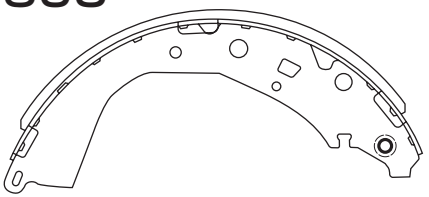
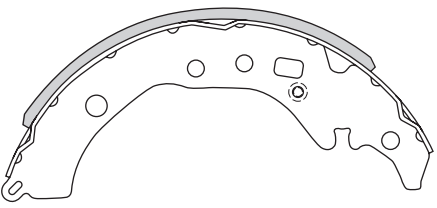
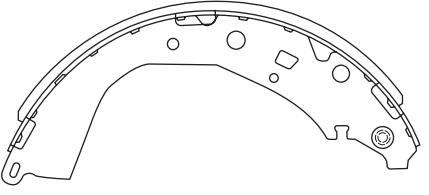
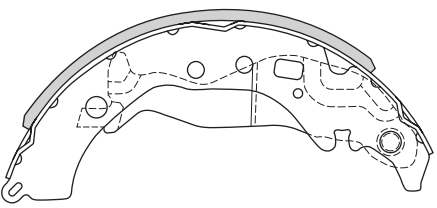
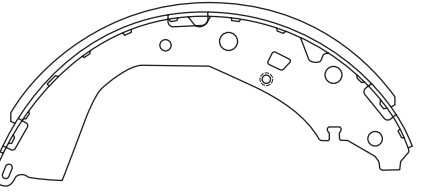
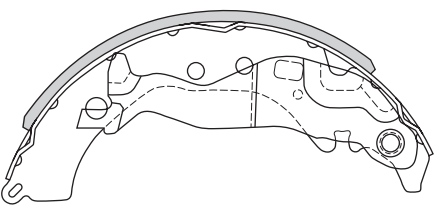
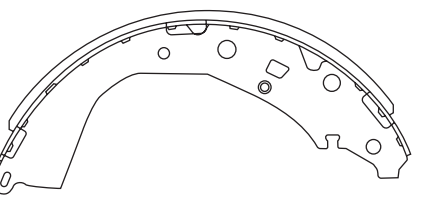
<p>FN-2411</p>  <p>LN2411 (Rear)</p> <table border="1" data-bbox="421 523 716 584"> <thead> <tr> <th>a</th> <th>b</th> <th>c</th> <th>r</th> </tr> </thead> <tbody> <tr> <td>4.5</td> <td>2.3</td> <td>40</td> <td>127</td> </tr> </tbody> </table> <p>2pcs.</p>	a	b	c	r	4.5	2.3	40	127	<p>FN-2801R</p>  <p>LN2801</p> <table border="1" data-bbox="1084 523 1379 584"> <thead> <tr> <th>a</th> <th>b</th> <th>c</th> <th>r</th> </tr> </thead> <tbody> <tr> <td>6</td> <td>3.5</td> <td>100</td> <td>160</td> </tr> </tbody> </table> <p>4pcs.</p>	a	b	c	r	6	3.5	100	160
a	b	c	r														
4.5	2.3	40	127														
a	b	c	r														
6	3.5	100	160														
 <p>LN2412</p> <table border="1" data-bbox="421 840 716 901"> <thead> <tr> <th>a</th> <th>b</th> <th>c</th> <th>r</th> </tr> </thead> <tbody> <tr> <td>4.5</td> <td>2.3</td> <td>40</td> <td>127</td> </tr> </tbody> </table> <p>2pcs.</p>	a	b	c	r	4.5	2.3	40	127	<p>FN-2802R</p>  <p>LN2802</p> <table border="1" data-bbox="1084 840 1379 901"> <thead> <tr> <th>a</th> <th>b</th> <th>c</th> <th>r</th> </tr> </thead> <tbody> <tr> <td>6</td> <td>3.5</td> <td>115</td> <td>160</td> </tr> </tbody> </table> <p>4pcs.</p>	a	b	c	r	6	3.5	115	160
a	b	c	r														
4.5	2.3	40	127														
a	b	c	r														
6	3.5	115	160														
<p>FN-2423</p>  <p>LN2383 (Rear)</p> <table border="1" data-bbox="421 1169 716 1230"> <thead> <tr> <th>a</th> <th>b</th> <th>c</th> <th>r</th> </tr> </thead> <tbody> <tr> <td>4</td> <td>2</td> <td>35</td> <td>114.3</td> </tr> </tbody> </table> <p>1pc.</p>	a	b	c	r	4	2	35	114.3	<p>FN-2803</p>  <p>LN2803 (Rear)</p> <table border="1" data-bbox="1084 1169 1379 1230"> <thead> <tr> <th>a</th> <th>b</th> <th>c</th> <th>r</th> </tr> </thead> <tbody> <tr> <td>4.5</td> <td>2.3</td> <td>49.5</td> <td>147</td> </tr> </tbody> </table> <p>1pc.</p>	a	b	c	r	4.5	2.3	49.5	147
a	b	c	r														
4	2	35	114.3														
a	b	c	r														
4.5	2.3	49.5	147														
 <p>LN2384</p> <table border="1" data-bbox="421 1485 716 1546"> <thead> <tr> <th>a</th> <th>b</th> <th>c</th> <th>r</th> </tr> </thead> <tbody> <tr> <td>4</td> <td>2</td> <td>35</td> <td>114.3</td> </tr> </tbody> </table> <p>1pc.</p>	a	b	c	r	4	2	35	114.3	 <p>LN2804</p> <table border="1" data-bbox="1084 1485 1379 1546"> <thead> <tr> <th>a</th> <th>b</th> <th>c</th> <th>r</th> </tr> </thead> <tbody> <tr> <td>4.5</td> <td>2.3</td> <td>49.5</td> <td>147</td> </tr> </tbody> </table> <p>1pc.</p>	a	b	c	r	4.5	2.3	49.5	147
a	b	c	r														
4	2	35	114.3														
a	b	c	r														
4.5	2.3	49.5	147														
 <p>LN2423</p> <table border="1" data-bbox="421 1802 716 1863"> <thead> <tr> <th>a</th> <th>b</th> <th>c</th> <th>r</th> </tr> </thead> <tbody> <tr> <td>4</td> <td>2</td> <td>35</td> <td>114.3</td> </tr> </tbody> </table> <p>1pc.</p>	a	b	c	r	4	2	35	114.3	 <p>LN2805</p> <table border="1" data-bbox="1084 1802 1379 1863"> <thead> <tr> <th>a</th> <th>b</th> <th>c</th> <th>r</th> </tr> </thead> <tbody> <tr> <td>4.5</td> <td>2.3</td> <td>49.5</td> <td>147</td> </tr> </tbody> </table> <p>1pc.</p>	a	b	c	r	4.5	2.3	49.5	147
a	b	c	r														
4	2	35	114.3														
a	b	c	r														
4.5	2.3	49.5	147														
 <p>LN2424</p> <table border="1" data-bbox="421 2119 716 2180"> <thead> <tr> <th>a</th> <th>b</th> <th>c</th> <th>r</th> </tr> </thead> <tbody> <tr> <td>4</td> <td>2</td> <td>35</td> <td>114.3</td> </tr> </tbody> </table> <p>1pc.</p>	a	b	c	r	4	2	35	114.3	 <p>LN2806</p> <table border="1" data-bbox="1084 2119 1379 2180"> <thead> <tr> <th>a</th> <th>b</th> <th>c</th> <th>r</th> </tr> </thead> <tbody> <tr> <td>4.5</td> <td>2.3</td> <td>49.5</td> <td>147</td> </tr> </tbody> </table> <p>1pc.</p>	a	b	c	r	4.5	2.3	49.5	147
a	b	c	r														
4	2	35	114.3														
a	b	c	r														
4.5	2.3	49.5	147														

FN-2901

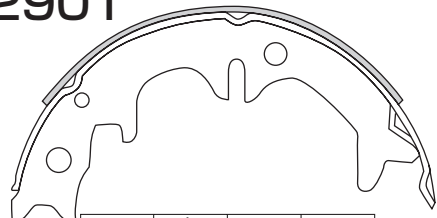

LN2901
(Rear)

a	b	c	r
6	2	30	84.5

2pcs.

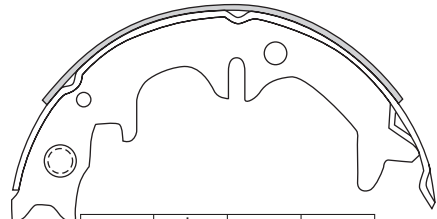

LN2902

a	b	c	r
6	2	30	84.5

1pcs.

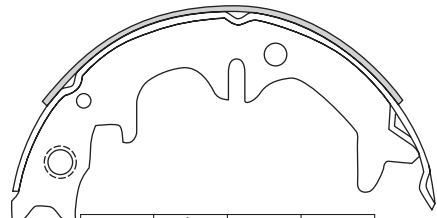

LN2903

a	b	c	r
6	2	30	84.5

1pcs.

FN-2904

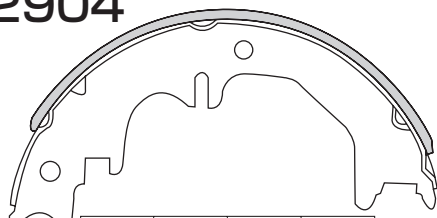

LN2904
(Rear)

a	b	c	r
6	2.5	30	105

2pcs.

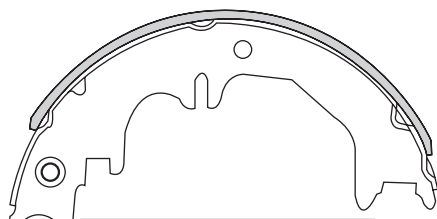

LN2905

a	b	c	r
6	2.5	30	105

1pcs.

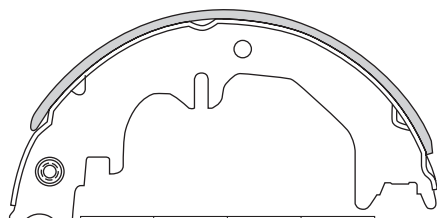





LN2906

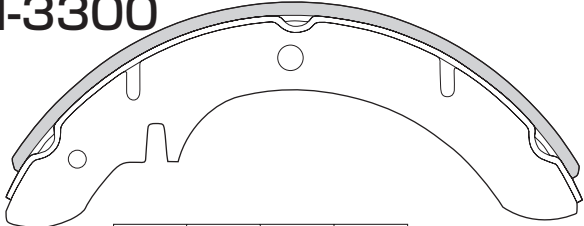
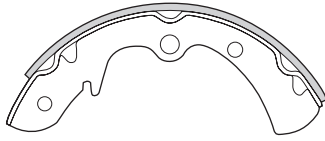
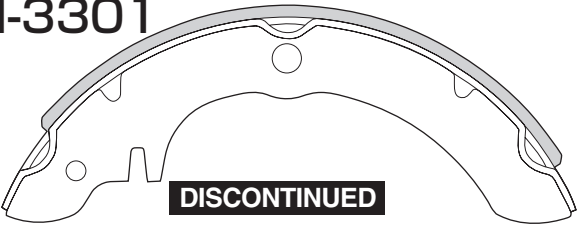
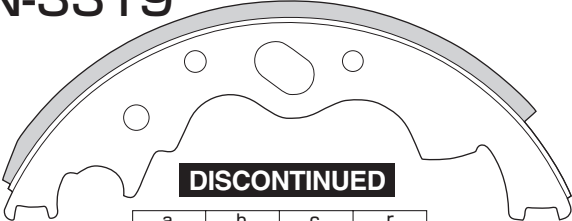
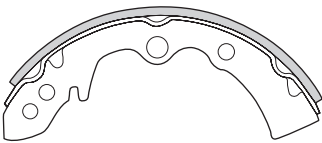
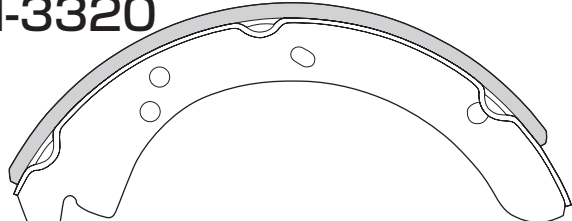

a	b	c	r
6	2.5	30	105



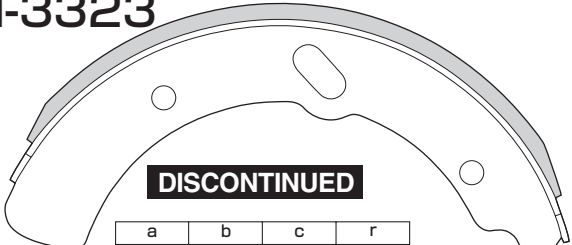
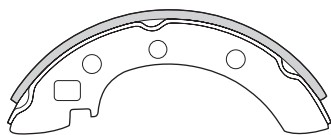
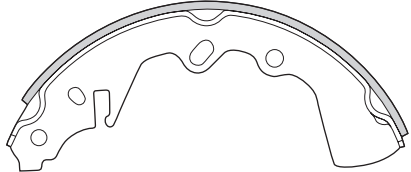

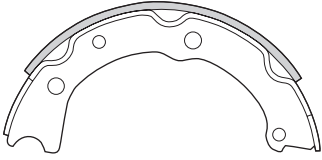
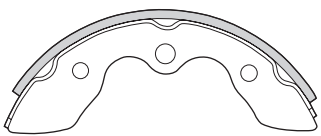
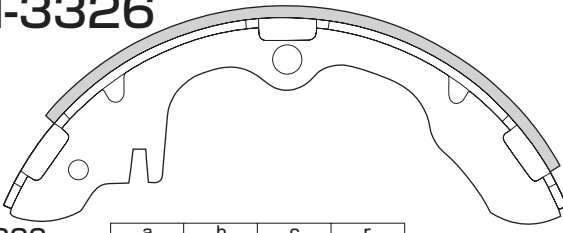
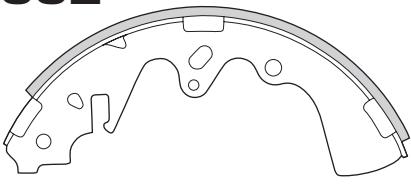
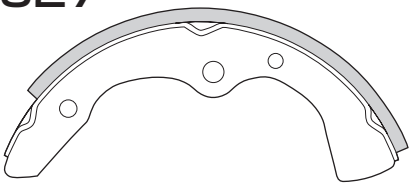
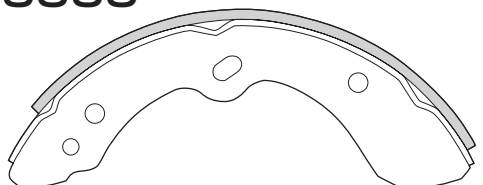
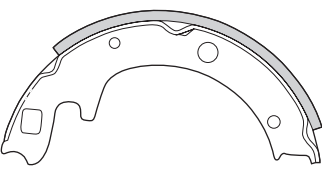
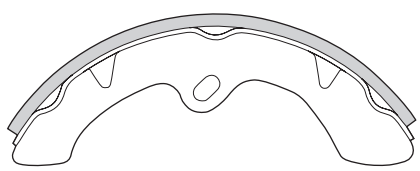
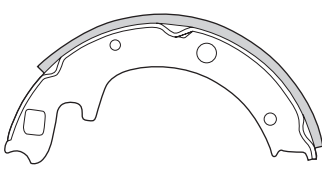
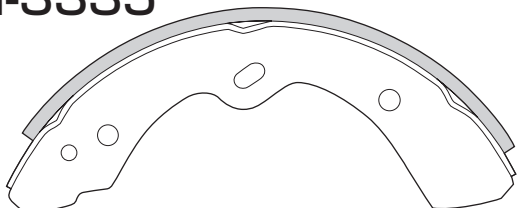
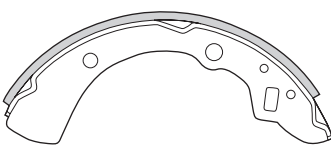
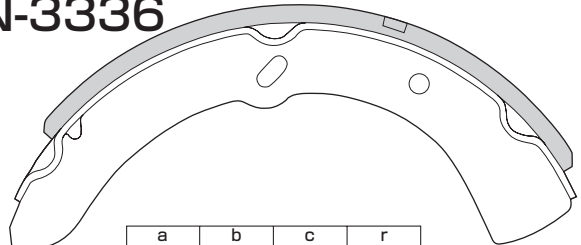

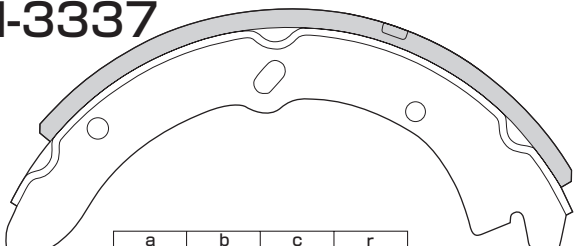
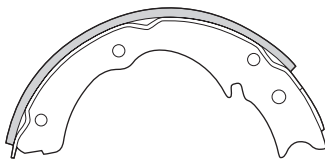
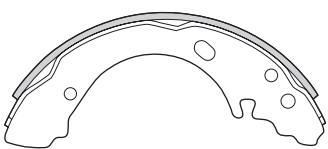
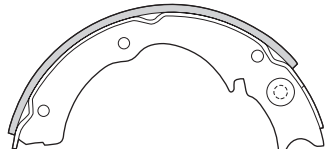
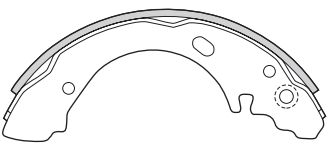
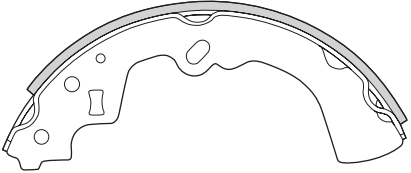
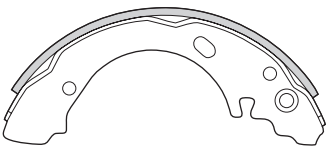
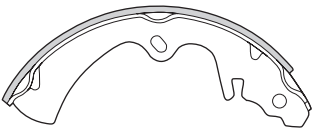
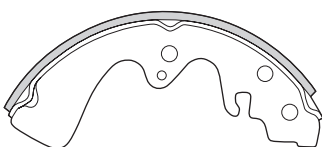
1pcs.

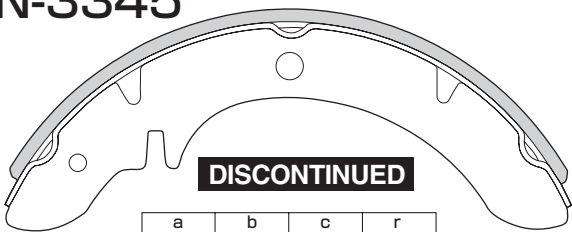

New Products

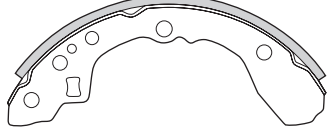

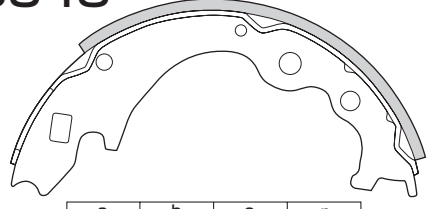
<p>FN-3300</p>  <p>LN3300(Front)</p> <table border="1" data-bbox="413 531 709 587"> <thead> <tr> <th>a</th> <th>b</th> <th>c</th> <th>r</th> </tr> </thead> <tbody> <tr> <td>4.5</td> <td>2.3</td> <td>60</td> <td>150</td> </tr> </tbody> </table> <p>4pcs.</p>	a	b	c	r	4.5	2.3	60	150	<p>FN-3317</p>  <p>LN3317(Rear)</p> <table border="1" data-bbox="1089 531 1385 587"> <thead> <tr> <th>a</th> <th>b</th> <th>c</th> <th>r</th> </tr> </thead> <tbody> <tr> <td>3.2</td> <td>2</td> <td>32</td> <td>100</td> </tr> </tbody> </table> <p>4pcs.</p>	a	b	c	r	3.2	2	32	100
a	b	c	r														
4.5	2.3	60	150														
a	b	c	r														
3.2	2	32	100														
<p>FN-3301</p>  <p>DISCONTINUED</p> <p>LN3301 (Front & Rear)</p> <table border="1" data-bbox="413 847 709 903"> <thead> <tr> <th>a</th> <th>b</th> <th>c</th> <th>r</th> </tr> </thead> <tbody> <tr> <td>4.5</td> <td>2.6</td> <td>45</td> <td>130</td> </tr> </tbody> </table> <p>4pcs.</p>	a	b	c	r	4.5	2.6	45	130	<p>FN-3319</p>  <p>DISCONTINUED</p> <p>LN3319(Rear)</p> <table border="1" data-bbox="1089 847 1385 903"> <thead> <tr> <th>a</th> <th>b</th> <th>c</th> <th>r</th> </tr> </thead> <tbody> <tr> <td>6</td> <td>3.2</td> <td>75</td> <td>160</td> </tr> </tbody> </table> <p>4pcs.</p>	a	b	c	r	6	3.2	75	160
a	b	c	r														
4.5	2.6	45	130														
a	b	c	r														
6	3.2	75	160														
<p>FN-3307</p>  <p>LN3307 (Front & Rear)</p> <table border="1" data-bbox="413 1171 709 1227"> <thead> <tr> <th>a</th> <th>b</th> <th>c</th> <th>r</th> </tr> </thead> <tbody> <tr> <td>3.2</td> <td>2</td> <td>32</td> <td>100</td> </tr> </tbody> </table> <p>4pcs.</p>	a	b	c	r	3.2	2	32	100	<p>FN-3320</p>  <p>LN3320 (Front & Rear)</p> <table border="1" data-bbox="1089 1171 1385 1227"> <thead> <tr> <th>a</th> <th>b</th> <th>c</th> <th>r</th> </tr> </thead> <tbody> <tr> <td>6</td> <td>2.6</td> <td>60</td> <td>160</td> </tr> </tbody> </table> <p>4pcs.</p>	a	b	c	r	6	2.6	60	160
a	b	c	r														
3.2	2	32	100														
a	b	c	r														
6	2.6	60	160														
<p>FN-3308</p>  <p>DISCONTINUED</p> <p>LN3308 (Front & Rear)</p> <table border="1" data-bbox="413 1490 709 1546"> <thead> <tr> <th>a</th> <th>b</th> <th>c</th> <th>r</th> </tr> </thead> <tbody> <tr> <td>4.5</td> <td>2.6</td> <td>40</td> <td>127</td> </tr> </tbody> </table> <p>4pcs.</p>	a	b	c	r	4.5	2.6	40	127	<p>FN-3322</p>  <p>DISCONTINUED</p> <p>LN3322(Front)</p> <table border="1" data-bbox="1089 1490 1385 1546"> <thead> <tr> <th>a</th> <th>b</th> <th>c</th> <th>r</th> </tr> </thead> <tbody> <tr> <td>3</td> <td>2</td> <td>32</td> <td>100</td> </tr> </tbody> </table> <p>4pcs.</p>	a	b	c	r	3	2	32	100
a	b	c	r														
4.5	2.6	40	127														
a	b	c	r														
3	2	32	100														
<p>FN-3315</p>  <p>DISCONTINUED</p> <p>LN3315(Front)</p> <table border="1" data-bbox="413 1812 709 1868"> <thead> <tr> <th>a</th> <th>b</th> <th>c</th> <th>r</th> </tr> </thead> <tbody> <tr> <td>3.2</td> <td>2</td> <td>30</td> <td>90</td> </tr> </tbody> </table> <p>4pcs.</p>	a	b	c	r	3.2	2	30	90	<p>FN-3323</p>  <p>DISCONTINUED</p> <p>LN3323(Front)</p> <table border="1" data-bbox="1089 1812 1385 1868"> <thead> <tr> <th>a</th> <th>b</th> <th>c</th> <th>r</th> </tr> </thead> <tbody> <tr> <td>6</td> <td>3.2</td> <td>75</td> <td>160</td> </tr> </tbody> </table> <p>4pcs.</p>	a	b	c	r	6	3.2	75	160
a	b	c	r														
3.2	2	30	90														
a	b	c	r														
6	3.2	75	160														
<p>FN-3316</p>  <p>LN3316(Rear)</p> <table border="1" data-bbox="413 2131 709 2187"> <thead> <tr> <th>a</th> <th>b</th> <th>c</th> <th>r</th> </tr> </thead> <tbody> <tr> <td>3.2</td> <td>1.6</td> <td>22</td> <td>82.5</td> </tr> </tbody> </table> <p>4pcs.</p>	a	b	c	r	3.2	1.6	22	82.5	<p>FN-3324</p>  <p>LN3324 (Front & Rear)</p> <table border="1" data-bbox="1089 2131 1385 2187"> <thead> <tr> <th>a</th> <th>b</th> <th>c</th> <th>r</th> </tr> </thead> <tbody> <tr> <td>4</td> <td>2</td> <td>42</td> <td>114.3</td> </tr> </tbody> </table> <p>4pcs.</p>	a	b	c	r	4	2	42	114.3
a	b	c	r														
3.2	1.6	22	82.5														
a	b	c	r														
4	2	42	114.3														

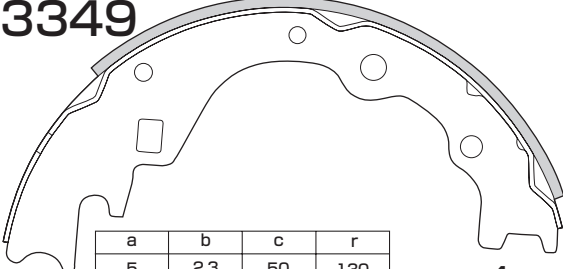
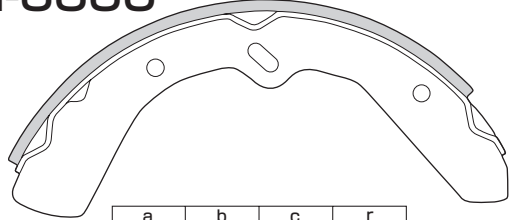
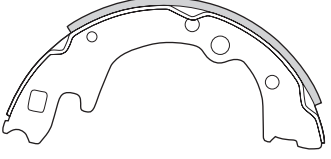
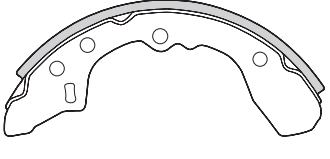
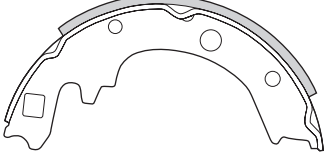
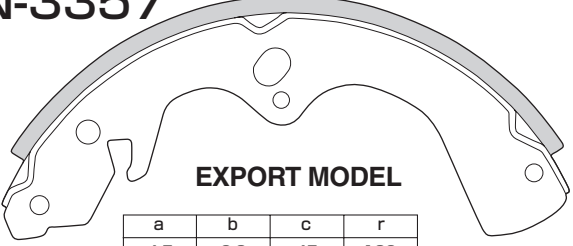
<p>FN-3325</p>  <p>LN3325 (Parking)</p> <table border="1" data-bbox="412 531 713 589"> <thead> <tr> <th>a</th> <th>b</th> <th>c</th> <th>r</th> </tr> </thead> <tbody> <tr> <td>4.5</td> <td>2.3</td> <td>30</td> <td>85</td> </tr> </tbody> </table> <p>2pcs.</p>	a	b	c	r	4.5	2.3	30	85	<p>FN-3330</p>  <p>LN3330(Front)</p> <table border="1" data-bbox="1089 531 1390 589"> <thead> <tr> <th>a</th> <th>b</th> <th>c</th> <th>r</th> </tr> </thead> <tbody> <tr> <td>3.2</td> <td>1.6</td> <td>30</td> <td>90</td> </tr> </tbody> </table> <p>4pcs.</p>	a	b	c	r	3.2	1.6	30	90
a	b	c	r														
4.5	2.3	30	85														
a	b	c	r														
3.2	1.6	30	90														
<p>FN-3326</p>  <p>LN3326 (Front & Rear)</p> <table border="1" data-bbox="412 852 713 911"> <thead> <tr> <th>a</th> <th>b</th> <th>c</th> <th>r</th> </tr> </thead> <tbody> <tr> <td>4.5</td> <td>3.2</td> <td>45</td> <td>130</td> </tr> </tbody> </table> <p>4pcs.</p>	a	b	c	r	4.5	3.2	45	130	<p>FN-3332</p>  <p>LN3332(Rear)</p> <table border="1" data-bbox="1089 852 1390 911"> <thead> <tr> <th>a</th> <th>b</th> <th>c</th> <th>r</th> </tr> </thead> <tbody> <tr> <td>4</td> <td>2</td> <td>42</td> <td>114.3</td> </tr> </tbody> </table> <p>4pcs.</p>	a	b	c	r	4	2	42	114.3
a	b	c	r														
4.5	3.2	45	130														
a	b	c	r														
4	2	42	114.3														
<p>FN-3327</p>  <p>LN3327(Front)</p> <table border="1" data-bbox="412 1169 713 1227"> <thead> <tr> <th>a</th> <th>b</th> <th>c</th> <th>r</th> </tr> </thead> <tbody> <tr> <td>4.5</td> <td>2.3</td> <td>55</td> <td>114.3</td> </tr> </tbody> </table> <p>4pcs.</p>	a	b	c	r	4.5	2.3	55	114.3	<p>FN-3333</p>  <p>LN3333(Front)</p> <table border="1" data-bbox="1089 1169 1390 1227"> <thead> <tr> <th>a</th> <th>b</th> <th>c</th> <th>r</th> </tr> </thead> <tbody> <tr> <td>4.5</td> <td>2.6</td> <td>60</td> <td>140</td> </tr> </tbody> </table> <p>4pcs.</p>	a	b	c	r	4.5	2.6	60	140
a	b	c	r														
4.5	2.3	55	114.3														
a	b	c	r														
4.5	2.6	60	140														
<p>FN-3328</p>  <p>LN3328 (Rear)</p> <table border="1" data-bbox="412 1485 713 1544"> <thead> <tr> <th>a</th> <th>b</th> <th>c</th> <th>r</th> </tr> </thead> <tbody> <tr> <td>4.5</td> <td>2</td> <td>45</td> <td>90</td> </tr> </tbody> </table> <p>2pcs.</p>	a	b	c	r	4.5	2	45	90	<p>FN-3334</p>  <p>LN3334(Rear)</p> <table border="1" data-bbox="1089 1485 1390 1544"> <thead> <tr> <th>a</th> <th>b</th> <th>c</th> <th>r</th> </tr> </thead> <tbody> <tr> <td>6</td> <td>2.9</td> <td>75</td> <td>114</td> </tr> </tbody> </table> <p>4pcs.</p>	a	b	c	r	6	2.9	75	114
a	b	c	r														
4.5	2	45	90														
a	b	c	r														
6	2.9	75	114														
<p>LN3328A</p>  <table border="1" data-bbox="412 1802 713 1861"> <thead> <tr> <th>a</th> <th>b</th> <th>c</th> <th>r</th> </tr> </thead> <tbody> <tr> <td>4.5</td> <td>2</td> <td>45</td> <td>90</td> </tr> </tbody> </table> <p>2pcs.</p>	a	b	c	r	4.5	2	45	90	<p>FN-3335</p>  <p>LN3335(Front)</p> <table border="1" data-bbox="1089 1802 1390 1861"> <thead> <tr> <th>a</th> <th>b</th> <th>c</th> <th>r</th> </tr> </thead> <tbody> <tr> <td>5</td> <td>2.9</td> <td>60</td> <td>150</td> </tr> </tbody> </table> <p>4pcs.</p>	a	b	c	r	5	2.9	60	150
a	b	c	r														
4.5	2	45	90														
a	b	c	r														
5	2.9	60	150														
<p>FN-3329</p>  <p>LN3329(Rear)</p> <table border="1" data-bbox="412 2119 713 2177"> <thead> <tr> <th>a</th> <th>b</th> <th>c</th> <th>r</th> </tr> </thead> <tbody> <tr> <td>3.2</td> <td>1.6</td> <td>30</td> <td>90</td> </tr> </tbody> </table> <p>4pcs.</p>	a	b	c	r	3.2	1.6	30	90	<p>FN-3336</p>  <p>LN3336(Front)</p> <table border="1" data-bbox="1089 2119 1390 2177"> <thead> <tr> <th>a</th> <th>b</th> <th>c</th> <th>r</th> </tr> </thead> <tbody> <tr> <td>6</td> <td>3.5</td> <td>75</td> <td>160</td> </tr> </tbody> </table> <p>4pcs.</p>	a	b	c	r	6	3.5	75	160
a	b	c	r														
3.2	1.6	30	90														
a	b	c	r														
6	3.5	75	160														

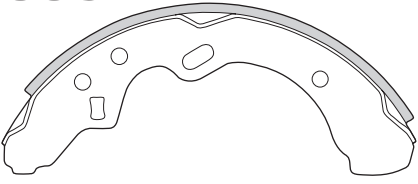
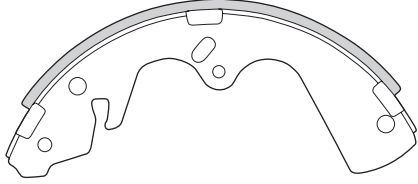
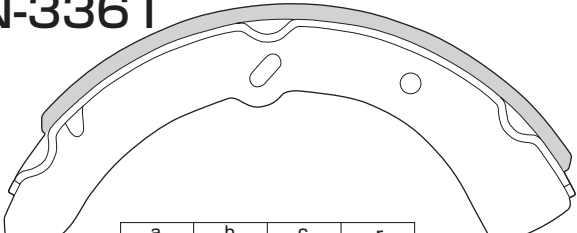
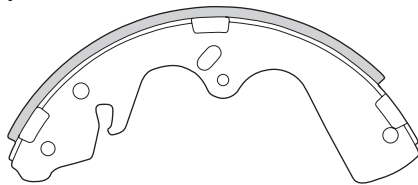
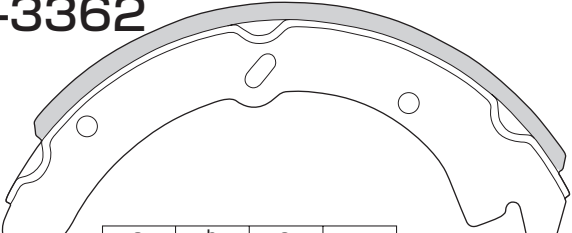
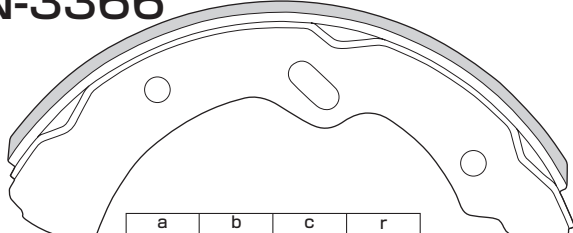
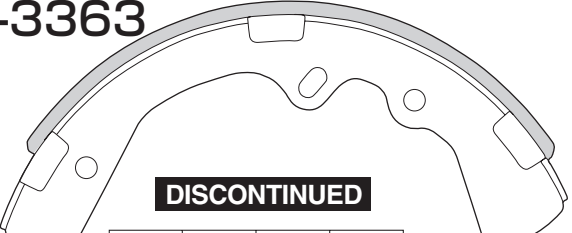
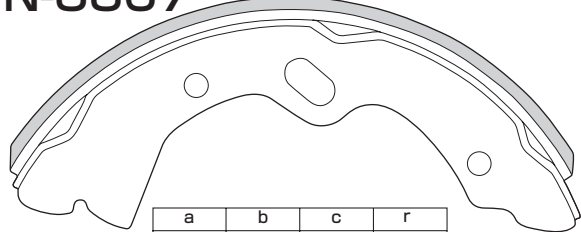

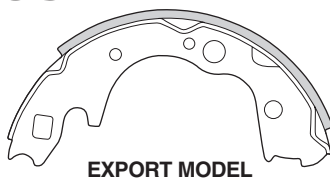
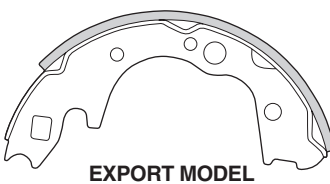

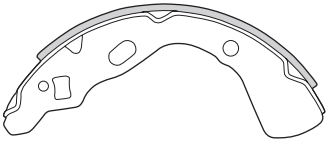
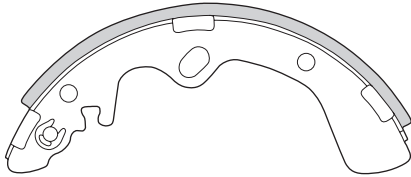
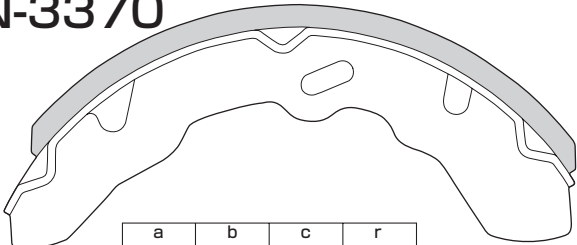
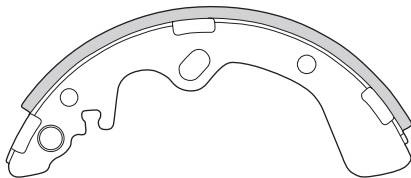
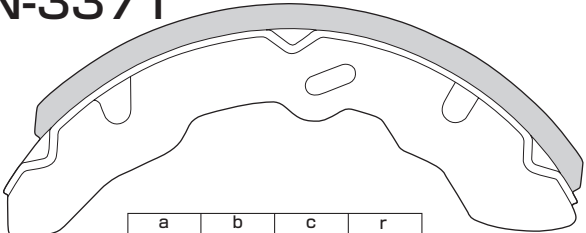
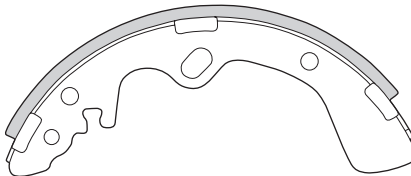
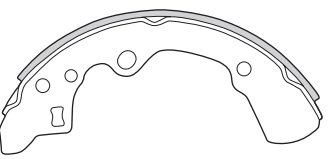
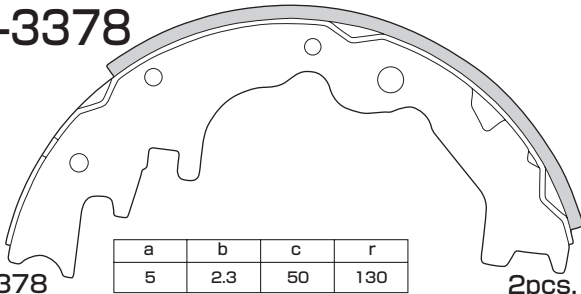
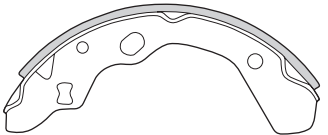
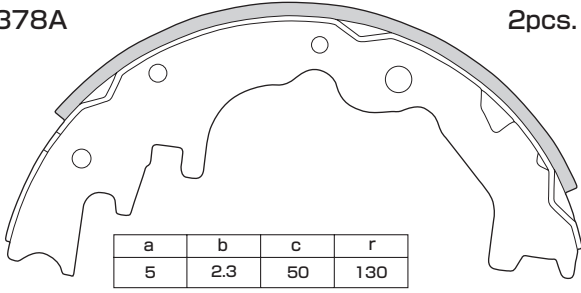

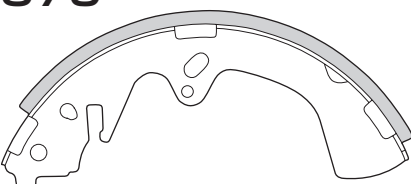
<p>FN-3337</p>  <p>LN3337(Rear) <table border="1" data-bbox="412 531 713 584"><tr><th>a</th><th>b</th><th>c</th><th>r</th></tr><tr><td>6</td><td>3.5</td><td>75</td><td>160</td></tr></table> 4pcs.</p>	a	b	c	r	6	3.5	75	160	<p>FN-3340</p>  <p>LN3340 (Parking) <table border="1" data-bbox="1084 531 1385 584"><tr><th>a</th><th>b</th><th>c</th><th>r</th></tr><tr><td>4.5</td><td>2</td><td>35</td><td>90</td></tr></table> 1pc.</p>	a	b	c	r	4.5	2	35	90
a	b	c	r														
6	3.5	75	160														
a	b	c	r														
4.5	2	35	90														
<p>FN-3338</p>  <p>LN3338 (Rear) <table border="1" data-bbox="412 847 713 901"><tr><th>a</th><th>b</th><th>c</th><th>r</th></tr><tr><td>3.2</td><td>2</td><td>32</td><td>100</td></tr></table> 2pcs.</p>	a	b	c	r	3.2	2	32	100	<p>LN3341</p>  <p><table border="1" data-bbox="1084 847 1385 901"><tr><th>a</th><th>b</th><th>c</th><th>r</th></tr><tr><td>4.5</td><td>2</td><td>35</td><td>90</td></tr></table> 1pc.</p>	a	b	c	r	4.5	2	35	90
a	b	c	r														
3.2	2	32	100														
a	b	c	r														
4.5	2	35	90														
<p>LN3359</p>  <p><table border="1" data-bbox="412 1164 713 1218"><tr><th>a</th><th>b</th><th>c</th><th>r</th></tr><tr><td>3.2</td><td>2</td><td>32</td><td>100</td></tr></table> 1pc.</p>	a	b	c	r	3.2	2	32	100	<p>FN-3342</p>  <p>LN3342(Rear) <table border="1" data-bbox="1084 1169 1385 1222"><tr><th>a</th><th>b</th><th>c</th><th>r</th></tr><tr><td>4</td><td>2</td><td>42</td><td>114.3</td></tr></table> 4pcs.</p>	a	b	c	r	4	2	42	114.3
a	b	c	r														
3.2	2	32	100														
a	b	c	r														
4	2	42	114.3														
<p>LN3360</p>  <p><table border="1" data-bbox="412 1481 713 1534"><tr><th>a</th><th>b</th><th>c</th><th>r</th></tr><tr><td>3.2</td><td>2</td><td>32</td><td>100</td></tr></table> 1pc.</p>	a	b	c	r	3.2	2	32	100	<p>FN-3343</p>  <p>LN3343(Rear) <table border="1" data-bbox="1084 1490 1385 1544"><tr><th>a</th><th>b</th><th>c</th><th>r</th></tr><tr><td>3.2</td><td>1.6</td><td>32</td><td>100</td></tr></table> 4pcs.</p>	a	b	c	r	3.2	1.6	32	100
a	b	c	r														
3.2	2	32	100														
a	b	c	r														
3.2	1.6	32	100														
<p>FN-3339</p>  <p>LN3339(Rear) <table border="1" data-bbox="412 1807 713 1861"><tr><th>a</th><th>b</th><th>c</th><th>r</th></tr><tr><td>3.2</td><td>1.6</td><td>32</td><td>100</td></tr></table> 4pcs.</p>	a	b	c	r	3.2	1.6	32	100	<p>FN-3344</p>  <p>EXPORT MODEL</p> <p>LN3344(Rear) <table border="1" data-bbox="1084 1807 1385 1861"><tr><th>a</th><th>b</th><th>c</th><th>r</th></tr><tr><td>4</td><td>2</td><td>42</td><td>114.3</td></tr></table> 4pcs.</p>	a	b	c	r	4	2	42	114.3
a	b	c	r														
3.2	1.6	32	100														
a	b	c	r														
4	2	42	114.3														
<p>FN-3345</p>  <p>DISCONTINUED</p> <p>LN3345(Front) <table border="1" data-bbox="1084 2124 1385 2177"><tr><th>a</th><th>b</th><th>c</th><th>r</th></tr><tr><td>6</td><td>2.3</td><td>60</td><td>150</td></tr></table> 4pcs.</p>		a	b	c	r	6	2.3	60	150								
a	b	c	r														
6	2.3	60	150														

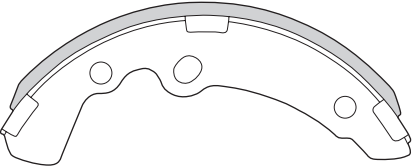
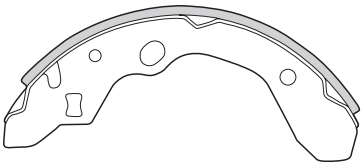
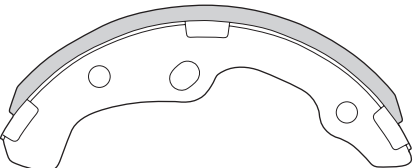
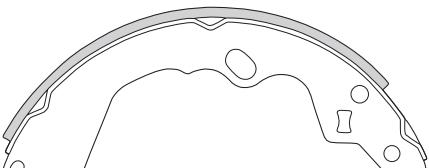
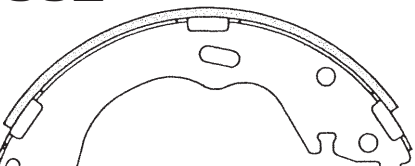
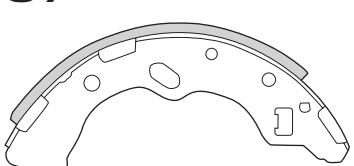
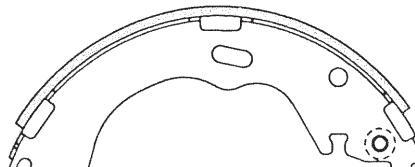
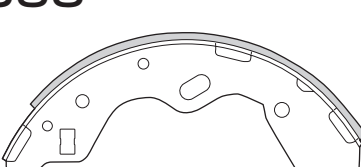
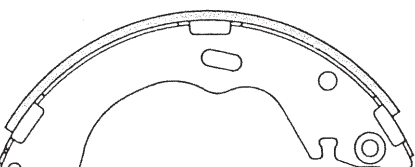
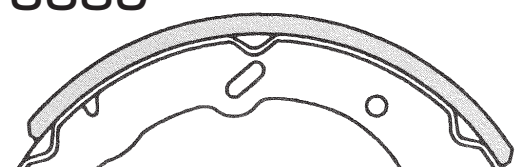
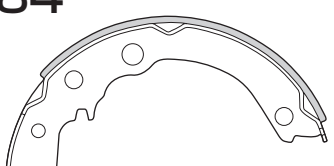
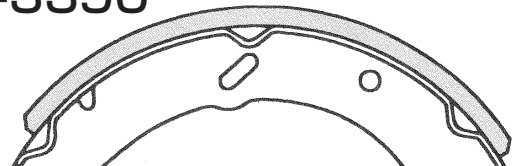
<p>FN-3346</p>  <p>DISCONTINUED</p> <table border="1" data-bbox="421 535 716 596"> <thead> <tr> <th>a</th> <th>b</th> <th>c</th> <th>r</th> </tr> </thead> <tbody> <tr> <td>6</td> <td>3.2</td> <td>75</td> <td>114</td> </tr> </tbody> </table> <p>LN3346(Rear) 4pcs.</p>	a	b	c	r	6	3.2	75	114	<p>FN-3352</p>  <p>DISCONTINUED</p> <table border="1" data-bbox="1102 535 1397 596"> <thead> <tr> <th>a</th> <th>b</th> <th>c</th> <th>r</th> </tr> </thead> <tbody> <tr> <td>4</td> <td>2</td> <td>42</td> <td>114.3</td> </tr> </tbody> </table> <p>LN3352(Rear) 4pcs.</p>	a	b	c	r	4	2	42	114.3
a	b	c	r														
6	3.2	75	114														
a	b	c	r														
4	2	42	114.3														
<p>FN-3347</p>  <table border="1" data-bbox="421 852 716 913"> <thead> <tr> <th>a</th> <th>b</th> <th>c</th> <th>r</th> </tr> </thead> <tbody> <tr> <td>2.9</td> <td>1.6</td> <td>25</td> <td>100</td> </tr> </tbody> </table> <p>LN3347(Rear) 4pcs.</p>	a	b	c	r	2.9	1.6	25	100	<p>FN-3353</p>  <p>DISCONTINUED</p> <table border="1" data-bbox="1102 852 1397 913"> <thead> <tr> <th>a</th> <th>b</th> <th>c</th> <th>r</th> </tr> </thead> <tbody> <tr> <td>4.5</td> <td>2</td> <td>54.2</td> <td>114.3</td> </tr> </tbody> </table> <p>LN3353 (Front) 2pcs.</p>	a	b	c	r	4.5	2	54.2	114.3
a	b	c	r														
2.9	1.6	25	100														
a	b	c	r														
4.5	2	54.2	114.3														
<p>FN-3348</p>  <table border="1" data-bbox="421 1181 716 1242"> <thead> <tr> <th>a</th> <th>b</th> <th>c</th> <th>r</th> </tr> </thead> <tbody> <tr> <td>4</td> <td>2</td> <td>42</td> <td>114.3</td> </tr> </tbody> </table> <p>LN3348(Rear) 4pcs.</p>	a	b	c	r	4	2	42	114.3	<p>LN3354</p>  <p>DISCONTINUED</p> <table border="1" data-bbox="1102 1181 1397 1242"> <thead> <tr> <th>a</th> <th>b</th> <th>c</th> <th>r</th> </tr> </thead> <tbody> <tr> <td>4.5</td> <td>2</td> <td>54.2</td> <td>114.3</td> </tr> </tbody> </table> <p>2pcs.</p>	a	b	c	r	4.5	2	54.2	114.3
a	b	c	r														
4	2	42	114.3														
a	b	c	r														
4.5	2	54.2	114.3														
<p>FN-3349</p>  <table border="1" data-bbox="421 1498 716 1559"> <thead> <tr> <th>a</th> <th>b</th> <th>c</th> <th>r</th> </tr> </thead> <tbody> <tr> <td>5</td> <td>2.3</td> <td>50</td> <td>130</td> </tr> </tbody> </table> <p>LN3349(Rear) 4pcs.</p>	a	b	c	r	5	2.3	50	130	<p>FN-3355</p>  <table border="1" data-bbox="1102 1498 1397 1559"> <thead> <tr> <th>a</th> <th>b</th> <th>c</th> <th>r</th> </tr> </thead> <tbody> <tr> <td>4.5</td> <td>2.3</td> <td>60</td> <td>130</td> </tr> </tbody> </table> <p>LN3355(Front) 4pcs.</p>	a	b	c	r	4.5	2.3	60	130
a	b	c	r														
5	2.3	50	130														
a	b	c	r														
4.5	2.3	60	130														
<p>FN-3350</p>  <table border="1" data-bbox="421 1814 716 1875"> <thead> <tr> <th>a</th> <th>b</th> <th>c</th> <th>r</th> </tr> </thead> <tbody> <tr> <td>5</td> <td>2</td> <td>55</td> <td>110</td> </tr> </tbody> </table> <p>LN3350(Rear) 4pcs.</p>	a	b	c	r	5	2	55	110	<p>FN-3356</p>  <table border="1" data-bbox="1102 1814 1397 1875"> <thead> <tr> <th>a</th> <th>b</th> <th>c</th> <th>r</th> </tr> </thead> <tbody> <tr> <td>2.9</td> <td>1.6</td> <td>25</td> <td>100</td> </tr> </tbody> </table> <p>LN3356(Rear) 4pcs.</p>	a	b	c	r	2.9	1.6	25	100
a	b	c	r														
5	2	55	110														
a	b	c	r														
2.9	1.6	25	100														
<p>FN-3351</p>  <table border="1" data-bbox="421 2131 716 2192"> <thead> <tr> <th>a</th> <th>b</th> <th>c</th> <th>r</th> </tr> </thead> <tbody> <tr> <td>4.5</td> <td>2</td> <td>45</td> <td>90</td> </tr> </tbody> </table> <p>LN3351(Rear) 4pcs.</p>	a	b	c	r	4.5	2	45	90	<p>FN-3357</p>  <p>EXPORT MODEL</p> <table border="1" data-bbox="1102 2131 1397 2192"> <thead> <tr> <th>a</th> <th>b</th> <th>c</th> <th>r</th> </tr> </thead> <tbody> <tr> <td>4.5</td> <td>2.3</td> <td>45</td> <td>130</td> </tr> </tbody> </table> <p>LN3357(Rear) 4pcs.</p>	a	b	c	r	4.5	2.3	45	130
a	b	c	r														
4.5	2	45	90														
a	b	c	r														
4.5	2.3	45	130														

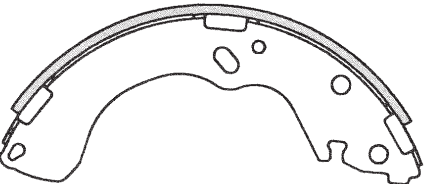
<p>FN-3358</p>  <p>LN3358(Rear)</p> <table border="1" data-bbox="415 531 713 589"> <thead> <tr> <th>a</th> <th>b</th> <th>c</th> <th>r</th> </tr> </thead> <tbody> <tr> <td>3.5</td> <td>1.6</td> <td>25</td> <td>114.3</td> </tr> </tbody> </table> <p>4pcs.</p>	a	b	c	r	3.5	1.6	25	114.3	<p>FN-3365</p>  <p>LN3365 (Rear)</p> <table border="1" data-bbox="1091 531 1388 589"> <thead> <tr> <th>a</th> <th>b</th> <th>c</th> <th>r</th> </tr> </thead> <tbody> <tr> <td>4</td> <td>2.3</td> <td>50</td> <td>127</td> </tr> </tbody> </table> <p>2pcs.</p>	a	b	c	r	4	2.3	50	127
a	b	c	r														
3.5	1.6	25	114.3														
a	b	c	r														
4	2.3	50	127														
<p>FN-3361</p>  <p>LN3361(Front)</p> <table border="1" data-bbox="415 852 713 911"> <thead> <tr> <th>a</th> <th>b</th> <th>c</th> <th>r</th> </tr> </thead> <tbody> <tr> <td>6</td> <td>3.5</td> <td>90</td> <td>160</td> </tr> </tbody> </table> <p>4pcs.</p>	a	b	c	r	6	3.5	90	160	<p>LN3365A</p>  <table border="1" data-bbox="1091 847 1388 906"> <thead> <tr> <th>a</th> <th>b</th> <th>c</th> <th>r</th> </tr> </thead> <tbody> <tr> <td>4</td> <td>2.3</td> <td>50</td> <td>127</td> </tr> </tbody> </table> <p>2pcs.</p>	a	b	c	r	4	2.3	50	127
a	b	c	r														
6	3.5	90	160														
a	b	c	r														
4	2.3	50	127														
<p>FN-3362</p>  <p>LN3362(Rear)</p> <table border="1" data-bbox="415 1169 713 1227"> <thead> <tr> <th>a</th> <th>b</th> <th>c</th> <th>r</th> </tr> </thead> <tbody> <tr> <td>6</td> <td>3.5</td> <td>90</td> <td>160</td> </tr> </tbody> </table> <p>4pcs.</p>	a	b	c	r	6	3.5	90	160	<p>FN-3366</p>  <p>LN3366(Front)</p> <table border="1" data-bbox="1091 1169 1388 1227"> <thead> <tr> <th>a</th> <th>b</th> <th>c</th> <th>r</th> </tr> </thead> <tbody> <tr> <td>6</td> <td>3.2</td> <td>90</td> <td>160</td> </tr> </tbody> </table> <p>4pcs.</p>	a	b	c	r	6	3.2	90	160
a	b	c	r														
6	3.5	90	160														
a	b	c	r														
6	3.2	90	160														
<p>FN-3363</p>  <p>DISCONTINUED</p> <p>LN3363(Front)</p> <table border="1" data-bbox="415 1485 713 1544"> <thead> <tr> <th>a</th> <th>b</th> <th>c</th> <th>r</th> </tr> </thead> <tbody> <tr> <td>4.5</td> <td>2.6</td> <td>50</td> <td>130</td> </tr> </tbody> </table> <p>4pcs.</p>	a	b	c	r	4.5	2.6	50	130	<p>FN-3367</p>  <p>LN3367(Rear)</p> <table border="1" data-bbox="1091 1485 1388 1544"> <thead> <tr> <th>a</th> <th>b</th> <th>c</th> <th>r</th> </tr> </thead> <tbody> <tr> <td>6</td> <td>3.2</td> <td>90</td> <td>160</td> </tr> </tbody> </table> <p>4pcs.</p>	a	b	c	r	6	3.2	90	160
a	b	c	r														
4.5	2.6	50	130														
a	b	c	r														
6	3.2	90	160														
<p>FN-3364</p>  <p>DISCONTINUED</p> <p>LN3364(Front)</p> <table border="1" data-bbox="415 1814 713 1873"> <thead> <tr> <th>a</th> <th>b</th> <th>c</th> <th>r</th> </tr> </thead> <tbody> <tr> <td>4.5</td> <td>2.3</td> <td>61</td> <td>127</td> </tr> </tbody> </table> <p>4pcs.</p>	a	b	c	r	4.5	2.3	61	127	<p>FN-3368</p>  <p>EXPORT MODEL</p> <p>LN3368 (Rear)</p> <table border="1" data-bbox="1091 1814 1388 1873"> <thead> <tr> <th>a</th> <th>b</th> <th>c</th> <th>r</th> </tr> </thead> <tbody> <tr> <td>4.5</td> <td>2</td> <td>45</td> <td>100</td> </tr> </tbody> </table> <p>2pcs.</p>	a	b	c	r	4.5	2	45	100
a	b	c	r														
4.5	2.3	61	127														
a	b	c	r														
4.5	2	45	100														
	<p>LN3368A</p>  <p>EXPORT MODEL</p> <table border="1" data-bbox="1091 2131 1388 2189"> <thead> <tr> <th>a</th> <th>b</th> <th>c</th> <th>r</th> </tr> </thead> <tbody> <tr> <td>4.5</td> <td>2</td> <td>45</td> <td>100</td> </tr> </tbody> </table> <p>2pcs.</p>	a	b	c	r	4.5	2	45	100								
a	b	c	r														
4.5	2	45	100														

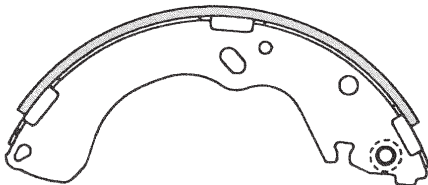
<p>FN-3369</p>  <p>LN3369(Rear)</p> <table border="1" data-bbox="415 531 713 587"> <thead> <tr> <th>a</th> <th>b</th> <th>c</th> <th>r</th> </tr> </thead> <tbody> <tr> <td>2.9</td> <td>1.6</td> <td>25</td> <td>85</td> </tr> </tbody> </table> <p>4pcs.</p>	a	b	c	r	2.9	1.6	25	85	<p>FN-3375</p>  <p>LN3375 (Rear)</p> <table border="1" data-bbox="1089 531 1383 587"> <thead> <tr> <th>a</th> <th>b</th> <th>c</th> <th>r</th> </tr> </thead> <tbody> <tr> <td>3.5</td> <td>2</td> <td>42</td> <td>114.3</td> </tr> </tbody> </table> <p>1pc.</p>	a	b	c	r	3.5	2	42	114.3
a	b	c	r														
2.9	1.6	25	85														
a	b	c	r														
3.5	2	42	114.3														
<p>FN-3370</p>  <p>LN3370(Front)</p> <table border="1" data-bbox="415 852 713 908"> <thead> <tr> <th>a</th> <th>b</th> <th>c</th> <th>r</th> </tr> </thead> <tbody> <tr> <td>5.0</td> <td>2.9</td> <td>90</td> <td>130</td> </tr> </tbody> </table> <p>4pcs.</p>	a	b	c	r	5.0	2.9	90	130	<p>LN3376</p>  <table border="1" data-bbox="1089 847 1383 903"> <thead> <tr> <th>a</th> <th>b</th> <th>c</th> <th>r</th> </tr> </thead> <tbody> <tr> <td>3.5</td> <td>2</td> <td>42</td> <td>114.3</td> </tr> </tbody> </table> <p>1pc.</p>	a	b	c	r	3.5	2	42	114.3
a	b	c	r														
5.0	2.9	90	130														
a	b	c	r														
3.5	2	42	114.3														
<p>FN-3371</p>  <p>LN3371(Rear)</p> <table border="1" data-bbox="415 1169 713 1225"> <thead> <tr> <th>a</th> <th>b</th> <th>c</th> <th>r</th> </tr> </thead> <tbody> <tr> <td>5.0</td> <td>2.9</td> <td>90</td> <td>130</td> </tr> </tbody> </table> <p>4pcs.</p>	a	b	c	r	5.0	2.9	90	130	<p>LN3377</p>  <table border="1" data-bbox="1089 1169 1383 1225"> <thead> <tr> <th>a</th> <th>b</th> <th>c</th> <th>r</th> </tr> </thead> <tbody> <tr> <td>3.5</td> <td>2</td> <td>42</td> <td>114.3</td> </tr> </tbody> </table> <p>2pcs.</p>	a	b	c	r	3.5	2	42	114.3
a	b	c	r														
5.0	2.9	90	130														
a	b	c	r														
3.5	2	42	114.3														
<p>FN-3372</p>  <p>LN3372(Rear)</p> <table border="1" data-bbox="415 1490 713 1546"> <thead> <tr> <th>a</th> <th>b</th> <th>c</th> <th>r</th> </tr> </thead> <tbody> <tr> <td>2.9</td> <td>1.6</td> <td>30</td> <td>114.3</td> </tr> </tbody> </table> <p>4pcs.</p>	a	b	c	r	2.9	1.6	30	114.3	<p>FN-3378</p>  <p>LN3378 (Rear)</p> <table border="1" data-bbox="1089 1490 1383 1546"> <thead> <tr> <th>a</th> <th>b</th> <th>c</th> <th>r</th> </tr> </thead> <tbody> <tr> <td>5</td> <td>2.3</td> <td>50</td> <td>130</td> </tr> </tbody> </table> <p>2pcs.</p>	a	b	c	r	5	2.3	50	130
a	b	c	r														
2.9	1.6	30	114.3														
a	b	c	r														
5	2.3	50	130														
<p>FN-3373</p>  <p>LN3373(Rear)</p> <table border="1" data-bbox="415 1814 713 1870"> <thead> <tr> <th>a</th> <th>b</th> <th>c</th> <th>r</th> </tr> </thead> <tbody> <tr> <td>2.9</td> <td>1.6</td> <td>25</td> <td>100</td> </tr> </tbody> </table> <p>4pcs.</p>	a	b	c	r	2.9	1.6	25	100	<p>LN3378A</p>  <table border="1" data-bbox="1089 1814 1383 1870"> <thead> <tr> <th>a</th> <th>b</th> <th>c</th> <th>r</th> </tr> </thead> <tbody> <tr> <td>5</td> <td>2.3</td> <td>50</td> <td>130</td> </tr> </tbody> </table> <p>2pcs.</p>	a	b	c	r	5	2.3	50	130
a	b	c	r														
2.9	1.6	25	100														
a	b	c	r														
5	2.3	50	130														
<p>FN-3374</p>  <p>LN3374(Rear)</p> <table border="1" data-bbox="415 2131 713 2187"> <thead> <tr> <th>a</th> <th>b</th> <th>c</th> <th>r</th> </tr> </thead> <tbody> <tr> <td>4</td> <td>2</td> <td>42</td> <td>114.3</td> </tr> </tbody> </table> <p>4pcs.</p>	a	b	c	r	4	2	42	114.3	<p>FN-3379</p>  <p>LN3379(Rear)</p> <table border="1" data-bbox="1089 2131 1383 2187"> <thead> <tr> <th>a</th> <th>b</th> <th>c</th> <th>r</th> </tr> </thead> <tbody> <tr> <td>4</td> <td>2</td> <td>42</td> <td>114.3</td> </tr> </tbody> </table> <p>4pcs.</p>	a	b	c	r	4	2	42	114.3
a	b	c	r														
4	2	42	114.3														
a	b	c	r														
4	2	42	114.3														

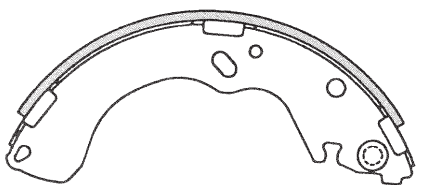
<p>FN-3380</p>  <p>LN3380 (Front)</p> <table border="1" data-bbox="415 531 713 589"> <thead> <tr> <th>a</th> <th>b</th> <th>c</th> <th>r</th> </tr> </thead> <tbody> <tr> <td>4.5</td> <td>2</td> <td>59</td> <td>114.3</td> </tr> </tbody> </table> <p>2pcs.</p>	a	b	c	r	4.5	2	59	114.3	<p>FN-3385</p>  <p>LN3385(Rear)</p> <table border="1" data-bbox="1096 531 1394 589"> <thead> <tr> <th>a</th> <th>b</th> <th>c</th> <th>r</th> </tr> </thead> <tbody> <tr> <td>2.9</td> <td>1.6</td> <td>35</td> <td>100</td> </tr> </tbody> </table> <p>4pcs.</p>	a	b	c	r	2.9	1.6	35	100
a	b	c	r														
4.5	2	59	114.3														
a	b	c	r														
2.9	1.6	35	100														
<p>LN3381</p>  <table border="1" data-bbox="415 847 713 906"> <thead> <tr> <th>a</th> <th>b</th> <th>c</th> <th>r</th> </tr> </thead> <tbody> <tr> <td>4.5</td> <td>2</td> <td>59</td> <td>114.3</td> </tr> </tbody> </table> <p>2pcs.</p>	a	b	c	r	4.5	2	59	114.3	<p>FN-3386</p>  <p>LN3386(Rear)</p> <table border="1" data-bbox="1096 847 1394 906"> <thead> <tr> <th>a</th> <th>b</th> <th>c</th> <th>r</th> </tr> </thead> <tbody> <tr> <td>3.2</td> <td>2</td> <td>30</td> <td>114.3</td> </tr> </tbody> </table> <p>4pcs.</p>	a	b	c	r	3.2	2	30	114.3
a	b	c	r														
4.5	2	59	114.3														
a	b	c	r														
3.2	2	30	114.3														
<p>FN-3382</p>  <p>LN3399 (Rear)</p> <table border="1" data-bbox="415 1164 713 1222"> <thead> <tr> <th>a</th> <th>b</th> <th>c</th> <th>r</th> </tr> </thead> <tbody> <tr> <td>4</td> <td>2</td> <td>41</td> <td>114.3</td> </tr> </tbody> </table> <p>2pcs.</p>	a	b	c	r	4	2	41	114.3	<p>FN-3387</p>  <p>LN3387(Rear)</p> <table border="1" data-bbox="1096 1164 1394 1222"> <thead> <tr> <th>a</th> <th>b</th> <th>c</th> <th>r</th> </tr> </thead> <tbody> <tr> <td>2.9</td> <td>1.6</td> <td>30</td> <td>90</td> </tr> </tbody> </table> <p>4pcs.</p>	a	b	c	r	2.9	1.6	30	90
a	b	c	r														
4	2	41	114.3														
a	b	c	r														
2.9	1.6	30	90														
<p>LN3382</p>  <table border="1" data-bbox="415 1481 713 1539"> <thead> <tr> <th>a</th> <th>b</th> <th>c</th> <th>r</th> </tr> </thead> <tbody> <tr> <td>4</td> <td>2</td> <td>41</td> <td>114.3</td> </tr> </tbody> </table> <p>1 pcs.</p>	a	b	c	r	4	2	41	114.3	<p>FN-3388</p>  <p>LN3388(Rear)</p> <table border="1" data-bbox="1096 1481 1394 1539"> <thead> <tr> <th>a</th> <th>b</th> <th>c</th> <th>r</th> </tr> </thead> <tbody> <tr> <td>2.9</td> <td>1.6</td> <td>30</td> <td>100</td> </tr> </tbody> </table> <p>4pcs.</p>	a	b	c	r	2.9	1.6	30	100
a	b	c	r														
4	2	41	114.3														
a	b	c	r														
2.9	1.6	30	100														
<p>LN3383</p>  <table border="1" data-bbox="415 1797 713 1856"> <thead> <tr> <th>a</th> <th>b</th> <th>c</th> <th>r</th> </tr> </thead> <tbody> <tr> <td>4</td> <td>2</td> <td>41</td> <td>114.3</td> </tr> </tbody> </table> <p>1 pcs.</p>	a	b	c	r	4	2	41	114.3	<p>FN-3389</p>  <p>LN3389(Rear)</p> <table border="1" data-bbox="1096 1797 1394 1856"> <thead> <tr> <th>a</th> <th>b</th> <th>c</th> <th>r</th> </tr> </thead> <tbody> <tr> <td>6</td> <td>3.2</td> <td>75</td> <td>150</td> </tr> </tbody> </table> <p>4pcs.</p>	a	b	c	r	6	3.2	75	150
a	b	c	r														
4	2	41	114.3														
a	b	c	r														
6	3.2	75	150														
<p>FN-3384</p>  <p>LN3384 (Parking)</p> <table border="1" data-bbox="415 2114 713 2172"> <thead> <tr> <th>a</th> <th>b</th> <th>c</th> <th>r</th> </tr> </thead> <tbody> <tr> <td>4.5</td> <td>2</td> <td>35</td> <td>95</td> </tr> </tbody> </table> <p>2pcs.</p>	a	b	c	r	4.5	2	35	95	<p>FN-3390</p>  <p>LN3390(Rear)</p> <table border="1" data-bbox="1096 2114 1394 2172"> <thead> <tr> <th>a</th> <th>b</th> <th>c</th> <th>r</th> </tr> </thead> <tbody> <tr> <td>6</td> <td>3.2</td> <td>75</td> <td>150</td> </tr> </tbody> </table> <p>4pcs.</p>	a	b	c	r	6	3.2	75	150
a	b	c	r														
4.5	2	35	95														
a	b	c	r														
6	3.2	75	150														

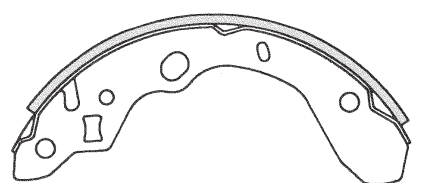
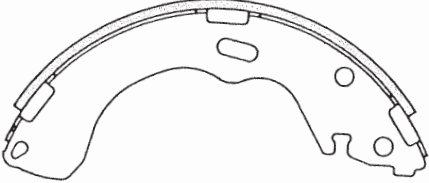
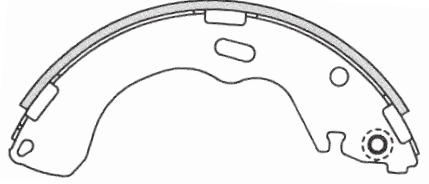
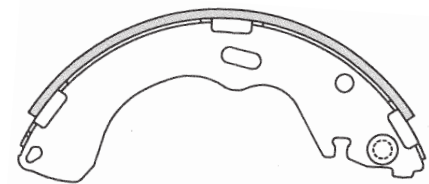
<p>FN-3391</p>  <p>LN3391 (Rear)</p> <table border="1" data-bbox="412 531 713 584"> <thead> <tr> <th>a</th> <th>b</th> <th>c</th> <th>r</th> </tr> </thead> <tbody> <tr> <td>4</td> <td>2</td> <td>41</td> <td>114.3</td> </tr> </tbody> </table> <p>2pcs.</p>	a	b	c	r	4	2	41	114.3	<p>FN-3395</p>  <p>EXPORT MODEL</p> <p>LN3395 (Rear)</p> <table border="1" data-bbox="1093 531 1388 584"> <thead> <tr> <th>a</th> <th>b</th> <th>c</th> <th>r</th> </tr> </thead> <tbody> <tr> <td>3.2</td> <td>1.6</td> <td>30</td> <td>90</td> </tr> </tbody> </table> <p>2pcs.</p>	a	b	c	r	3.2	1.6	30	90
a	b	c	r														
4	2	41	114.3														
a	b	c	r														
3.2	1.6	30	90														
 <p>LN3392</p> <table border="1" data-bbox="412 847 713 901"> <thead> <tr> <th>a</th> <th>b</th> <th>c</th> <th>r</th> </tr> </thead> <tbody> <tr> <td>4</td> <td>2</td> <td>41</td> <td>114.3</td> </tr> </tbody> </table> <p>1pc.</p>	a	b	c	r	4	2	41	114.3	 <p>EXPORT MODEL</p> <p>LN3397</p> <table border="1" data-bbox="1093 847 1388 901"> <thead> <tr> <th>a</th> <th>b</th> <th>c</th> <th>r</th> </tr> </thead> <tbody> <tr> <td>3.2</td> <td>1.6</td> <td>30</td> <td>90</td> </tr> </tbody> </table> <p>1pc.</p>	a	b	c	r	3.2	1.6	30	90
a	b	c	r														
4	2	41	114.3														
a	b	c	r														
3.2	1.6	30	90														
 <p>LN3393</p> <table border="1" data-bbox="412 1164 713 1218"> <thead> <tr> <th>a</th> <th>b</th> <th>c</th> <th>r</th> </tr> </thead> <tbody> <tr> <td>4</td> <td>2</td> <td>41</td> <td>114.3</td> </tr> </tbody> </table> <p>1pc.</p>	a	b	c	r	4	2	41	114.3	 <p>EXPORT MODEL</p> <p>LN3398</p> <table border="1" data-bbox="1093 1164 1388 1218"> <thead> <tr> <th>a</th> <th>b</th> <th>c</th> <th>r</th> </tr> </thead> <tbody> <tr> <td>3.2</td> <td>1.6</td> <td>30</td> <td>90</td> </tr> </tbody> </table> <p>1pc.</p>	a	b	c	r	3.2	1.6	30	90
a	b	c	r														
4	2	41	114.3														
a	b	c	r														
3.2	1.6	30	90														
<p>FN-3394</p>  <p>LN3394(Rear)</p> <table border="1" data-bbox="412 1493 713 1546"> <thead> <tr> <th>a</th> <th>b</th> <th>c</th> <th>r</th> </tr> </thead> <tbody> <tr> <td>2.9</td> <td>1.6</td> <td>35</td> <td>100</td> </tr> </tbody> </table> <p>4pcs.</p>	a	b	c	r	2.9	1.6	35	100	<p>FN-3399</p>  <p>LN3399 (Rear)</p> <table border="1" data-bbox="1093 1493 1388 1546"> <thead> <tr> <th>a</th> <th>b</th> <th>c</th> <th>r</th> </tr> </thead> <tbody> <tr> <td>4</td> <td>2</td> <td>41</td> <td>114.3</td> </tr> </tbody> </table> <p>2pcs.</p>	a	b	c	r	4	2	41	114.3
a	b	c	r														
2.9	1.6	35	100														
a	b	c	r														
4	2	41	114.3														
	 <p>LN3400</p> <table border="1" data-bbox="1093 1809 1388 1863"> <thead> <tr> <th>a</th> <th>b</th> <th>c</th> <th>r</th> </tr> </thead> <tbody> <tr> <td>4</td> <td>2</td> <td>41</td> <td>114.3</td> </tr> </tbody> </table> <p>1pc.</p>	a	b	c	r	4	2	41	114.3								
a	b	c	r														
4	2	41	114.3														
	 <p>LN3401</p> <table border="1" data-bbox="1093 2126 1388 2180"> <thead> <tr> <th>a</th> <th>b</th> <th>c</th> <th>r</th> </tr> </thead> <tbody> <tr> <td>4</td> <td>2</td> <td>41</td> <td>114.3</td> </tr> </tbody> </table> <p>1pc.</p>	a	b	c	r	4	2	41	114.3								
a	b	c	r														
4	2	41	114.3														

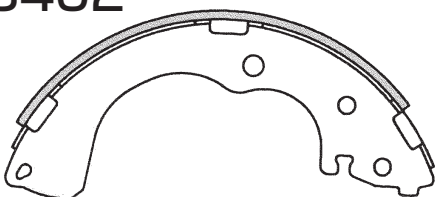
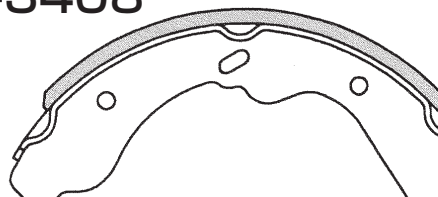
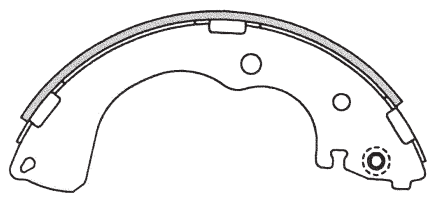
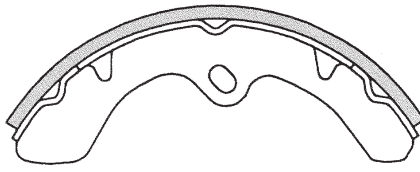
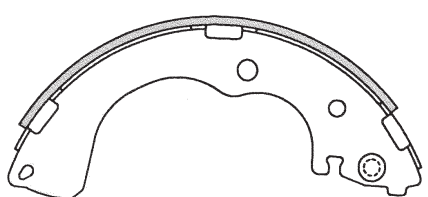
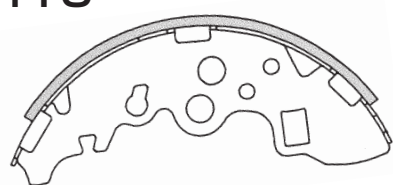
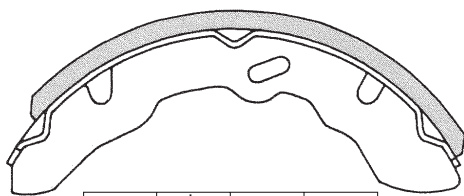
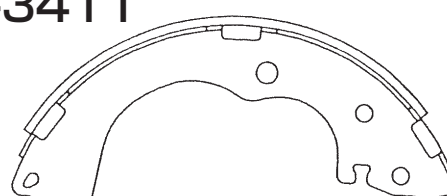
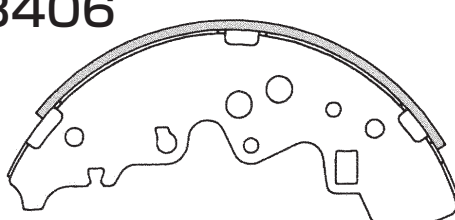
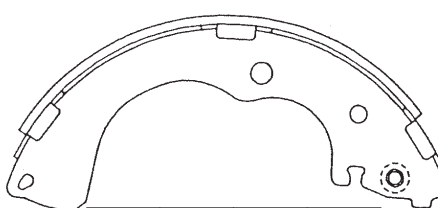
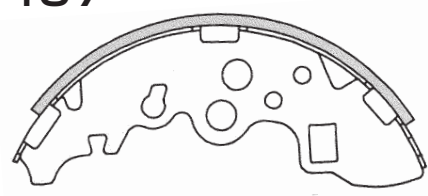
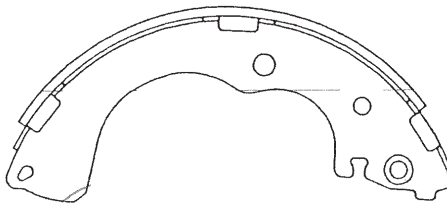
<p>FN-3402</p>  <p>LN3402 (Rear)</p> <table border="1" data-bbox="412 523 707 584"> <thead> <tr> <th>a</th> <th>b</th> <th>c</th> <th>r</th> </tr> </thead> <tbody> <tr> <td>4</td> <td>2.3</td> <td>50</td> <td>127</td> </tr> </tbody> </table> <p>2pcs.</p>	a	b	c	r	4	2.3	50	127	<p>FN-3408</p>  <p>LN3408 (Front&Rear)</p> <table border="1" data-bbox="1084 523 1379 584"> <thead> <tr> <th>a</th> <th>b</th> <th>c</th> <th>r</th> </tr> </thead> <tbody> <tr> <td>6</td> <td>3.5</td> <td>90</td> <td>160</td> </tr> </tbody> </table> <p>4pcs.</p>	a	b	c	r	6	3.5	90	160
a	b	c	r														
4	2.3	50	127														
a	b	c	r														
6	3.5	90	160														
<p>FN-3403</p>  <p>LN3403</p> <table border="1" data-bbox="412 840 707 901"> <thead> <tr> <th>a</th> <th>b</th> <th>c</th> <th>r</th> </tr> </thead> <tbody> <tr> <td>4</td> <td>2.3</td> <td>50</td> <td>127</td> </tr> </tbody> </table> <p>1pc.</p>	a	b	c	r	4	2.3	50	127	<p>FN-3409</p>  <p>LN3409(Rear)</p> <table border="1" data-bbox="1084 840 1379 901"> <thead> <tr> <th>a</th> <th>b</th> <th>c</th> <th>r</th> </tr> </thead> <tbody> <tr> <td>6</td> <td>2.9</td> <td>75</td> <td>114.3</td> </tr> </tbody> </table> <p>4pcs.</p>	a	b	c	r	6	2.9	75	114.3
a	b	c	r														
4	2.3	50	127														
a	b	c	r														
6	2.9	75	114.3														
<p>FN-3404</p>  <p>LN3404</p> <table border="1" data-bbox="412 1157 707 1218"> <thead> <tr> <th>a</th> <th>b</th> <th>c</th> <th>r</th> </tr> </thead> <tbody> <tr> <td>4</td> <td>2.3</td> <td>50</td> <td>127</td> </tr> </tbody> </table> <p>1pc.</p>	a	b	c	r	4	2.3	50	127	<p>FN-3410</p>  <p>LN3410(Rear)</p> <table border="1" data-bbox="1084 1157 1379 1218"> <thead> <tr> <th>a</th> <th>b</th> <th>c</th> <th>r</th> </tr> </thead> <tbody> <tr> <td>4</td> <td>2</td> <td>40</td> <td>110</td> </tr> </tbody> </table> <p>4pcs.</p>	a	b	c	r	4	2	40	110
a	b	c	r														
4	2.3	50	127														
a	b	c	r														
4	2	40	110														
<p>FN-3405</p>  <p>LN3405(Rear)</p> <table border="1" data-bbox="412 1485 707 1546"> <thead> <tr> <th>a</th> <th>b</th> <th>c</th> <th>r</th> </tr> </thead> <tbody> <tr> <td>5</td> <td>2.9</td> <td>90</td> <td>130</td> </tr> </tbody> </table> <p>4pcs.</p>	a	b	c	r	5	2.9	90	130	<p>FN-3411</p>  <p>LN3402 (Rear)</p> <table border="1" data-bbox="1084 1485 1379 1546"> <thead> <tr> <th>a</th> <th>b</th> <th>c</th> <th>r</th> </tr> </thead> <tbody> <tr> <td>4</td> <td>2.3</td> <td>50</td> <td>127</td> </tr> </tbody> </table> <p>2pcs.</p>	a	b	c	r	4	2.3	50	127
a	b	c	r														
5	2.9	90	130														
a	b	c	r														
4	2.3	50	127														
<p>FN-3406</p>  <p>LN3406(Rear)</p> <table border="1" data-bbox="412 1802 707 1863"> <thead> <tr> <th>a</th> <th>b</th> <th>c</th> <th>r</th> </tr> </thead> <tbody> <tr> <td>4</td> <td>2</td> <td>50</td> <td>135</td> </tr> </tbody> </table> <p>4pcs.</p>	a	b	c	r	4	2	50	135	<p>FN-3411</p>  <p>LN3411</p> <table border="1" data-bbox="1084 1802 1379 1863"> <thead> <tr> <th>a</th> <th>b</th> <th>c</th> <th>r</th> </tr> </thead> <tbody> <tr> <td>4</td> <td>2.3</td> <td>50</td> <td>127</td> </tr> </tbody> </table> <p>1pcs.</p>	a	b	c	r	4	2.3	50	127
a	b	c	r														
4	2	50	135														
a	b	c	r														
4	2.3	50	127														
<p>FN-3407</p>  <p>LN3407(Rear)</p> <table border="1" data-bbox="412 2119 707 2180"> <thead> <tr> <th>a</th> <th>b</th> <th>c</th> <th>r</th> </tr> </thead> <tbody> <tr> <td>4</td> <td>2</td> <td>55</td> <td>110</td> </tr> </tbody> </table> <p>4pcs.</p>	a	b	c	r	4	2	55	110	<p>FN-3412</p>  <p>LN3412</p> <table border="1" data-bbox="1084 2119 1379 2180"> <thead> <tr> <th>a</th> <th>b</th> <th>c</th> <th>r</th> </tr> </thead> <tbody> <tr> <td>4</td> <td>2.3</td> <td>50</td> <td>127</td> </tr> </tbody> </table> <p>1pcs.</p>	a	b	c	r	4	2.3	50	127
a	b	c	r														
4	2	55	110														
a	b	c	r														
4	2.3	50	127														

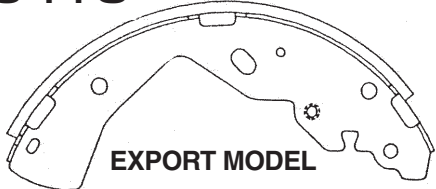
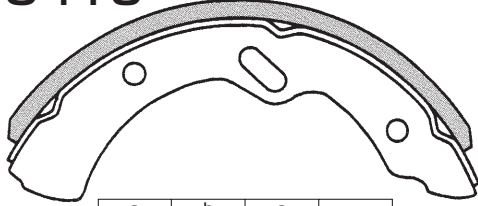
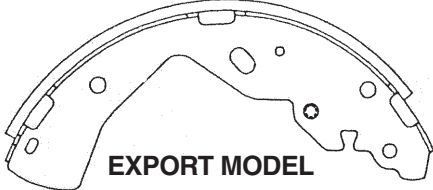
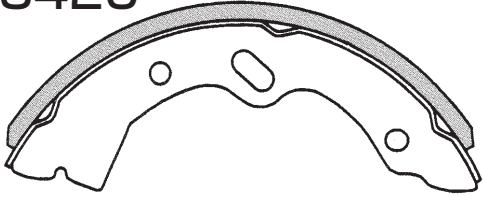
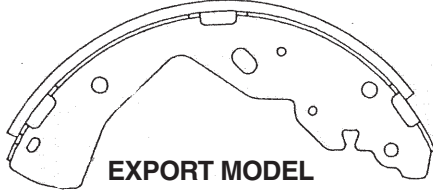
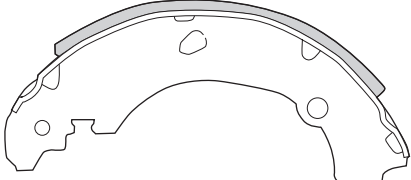
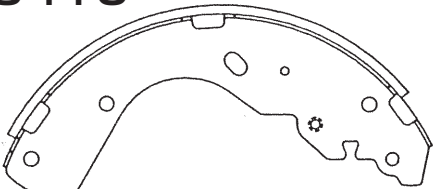
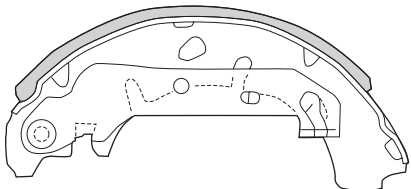
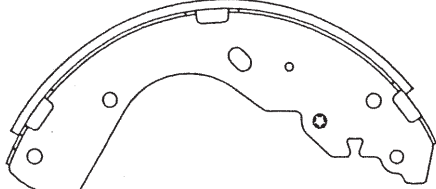
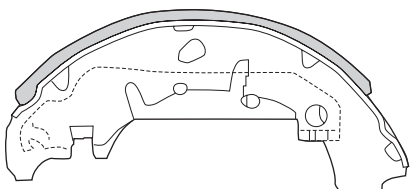
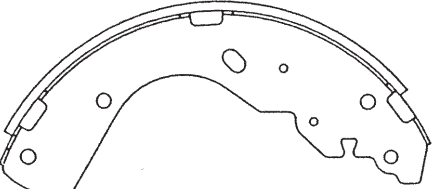
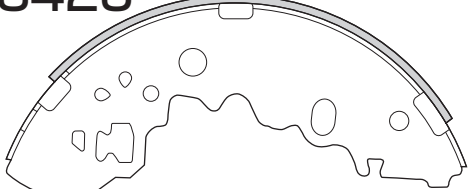
<p>FN-3413</p>  <p>EXPORT MODEL</p> <table border="1" data-bbox="413 531 709 587"> <thead> <tr> <th>a</th> <th>b</th> <th>c</th> <th>r</th> </tr> </thead> <tbody> <tr> <td>4.5</td> <td>2.3</td> <td>55</td> <td>135</td> </tr> </tbody> </table> <p>LN3413 (Rear) 1 pcs.</p>	a	b	c	r	4.5	2.3	55	135	<p>FN-3419</p>  <table border="1" data-bbox="1089 531 1385 587"> <thead> <tr> <th>a</th> <th>b</th> <th>c</th> <th>r</th> </tr> </thead> <tbody> <tr> <td>6</td> <td>3.2</td> <td>110</td> <td>160</td> </tr> </tbody> </table> <p>LN3419(Front) 4 pcs.</p>	a	b	c	r	6	3.2	110	160
a	b	c	r														
4.5	2.3	55	135														
a	b	c	r														
6	3.2	110	160														
<p>FN-3414</p>  <p>EXPORT MODEL</p> <table border="1" data-bbox="413 847 709 903"> <thead> <tr> <th>a</th> <th>b</th> <th>c</th> <th>r</th> </tr> </thead> <tbody> <tr> <td>4.5</td> <td>2.3</td> <td>55</td> <td>135</td> </tr> </tbody> </table> <p>LN3414 1 pcs.</p>	a	b	c	r	4.5	2.3	55	135	<p>FN-3420</p>  <table border="1" data-bbox="1089 847 1385 903"> <thead> <tr> <th>a</th> <th>b</th> <th>c</th> <th>r</th> </tr> </thead> <tbody> <tr> <td>6</td> <td>3.2</td> <td>110</td> <td>160</td> </tr> </tbody> </table> <p>LN3420(Rear) 4 pcs.</p>	a	b	c	r	6	3.2	110	160
a	b	c	r														
4.5	2.3	55	135														
a	b	c	r														
6	3.2	110	160														
<p>FN-3415</p>  <p>EXPORT MODEL</p> <table border="1" data-bbox="413 1171 709 1227"> <thead> <tr> <th>a</th> <th>b</th> <th>c</th> <th>r</th> </tr> </thead> <tbody> <tr> <td>4.5</td> <td>2.3</td> <td>55</td> <td>135</td> </tr> </tbody> </table> <p>LN3415 2 pcs.</p>	a	b	c	r	4.5	2.3	55	135	<p>FN-3421</p>  <table border="1" data-bbox="1089 1171 1385 1227"> <thead> <tr> <th>a</th> <th>b</th> <th>c</th> <th>r</th> </tr> </thead> <tbody> <tr> <td>3.2</td> <td>1.6</td> <td>35</td> <td>101.6</td> </tr> </tbody> </table> <p>LN3421 2 pcs.</p>	a	b	c	r	3.2	1.6	35	101.6
a	b	c	r														
4.5	2.3	55	135														
a	b	c	r														
3.2	1.6	35	101.6														
<p>FN-3416</p>  <table border="1" data-bbox="413 1490 709 1546"> <thead> <tr> <th>a</th> <th>b</th> <th>c</th> <th>r</th> </tr> </thead> <tbody> <tr> <td>4.5</td> <td>2.3</td> <td>55</td> <td>147.5</td> </tr> </tbody> </table> <p>LN3416 (Rear) 1 pc.</p>	a	b	c	r	4.5	2.3	55	147.5	<p>FN-3423</p>  <table border="1" data-bbox="1089 1490 1385 1546"> <thead> <tr> <th>a</th> <th>b</th> <th>c</th> <th>r</th> </tr> </thead> <tbody> <tr> <td>3.2</td> <td>1.6</td> <td>35</td> <td>101.6</td> </tr> </tbody> </table> <p>LN3423 1 pc.</p>	a	b	c	r	3.2	1.6	35	101.6
a	b	c	r														
4.5	2.3	55	147.5														
a	b	c	r														
3.2	1.6	35	101.6														
<p>FN-3417</p>  <table border="1" data-bbox="413 1809 709 1865"> <thead> <tr> <th>a</th> <th>b</th> <th>c</th> <th>r</th> </tr> </thead> <tbody> <tr> <td>4.5</td> <td>2.3</td> <td>55</td> <td>147.5</td> </tr> </tbody> </table> <p>LN3417 1 pc.</p>	a	b	c	r	4.5	2.3	55	147.5	<p>FN-3424</p>  <table border="1" data-bbox="1089 1809 1385 1865"> <thead> <tr> <th>a</th> <th>b</th> <th>c</th> <th>r</th> </tr> </thead> <tbody> <tr> <td>3.2</td> <td>1.6</td> <td>35</td> <td>101.6</td> </tr> </tbody> </table> <p>LN3424 1 pc.</p>	a	b	c	r	3.2	1.6	35	101.6
a	b	c	r														
4.5	2.3	55	147.5														
a	b	c	r														
3.2	1.6	35	101.6														
<p>FN-3418</p>  <table border="1" data-bbox="413 2133 709 2189"> <thead> <tr> <th>a</th> <th>b</th> <th>c</th> <th>r</th> </tr> </thead> <tbody> <tr> <td>4.5</td> <td>2.3</td> <td>55</td> <td>147.5</td> </tr> </tbody> </table> <p>LN3418 2 pcs.</p>	a	b	c	r	4.5	2.3	55	147.5	<p>FN-3425</p>  <table border="1" data-bbox="1089 2133 1385 2189"> <thead> <tr> <th>a</th> <th>b</th> <th>c</th> <th>r</th> </tr> </thead> <tbody> <tr> <td>4</td> <td>2</td> <td>50</td> <td>135</td> </tr> </tbody> </table> <p>LN3425(Rear) 4 pcs.</p>	a	b	c	r	4	2	50	135
a	b	c	r														
4.5	2.3	55	147.5														
a	b	c	r														
4	2	50	135														

FN-3426

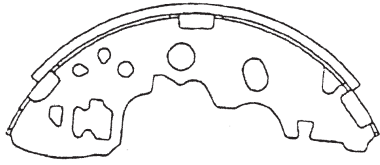

LN3426(Rear)

a	b	c	r
4	2	55	110

4pcs.

FN-3431

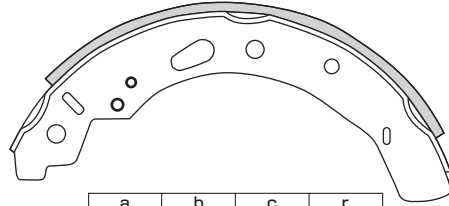

LN3431

(Rear)

a	b	c	r
3.2	2	30	100

2pcs.

FN-3427

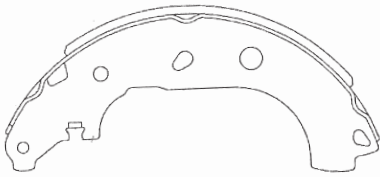

LN3427

(Rear)

a	b	c	r
3.5	2	40	114.3

2pcs.

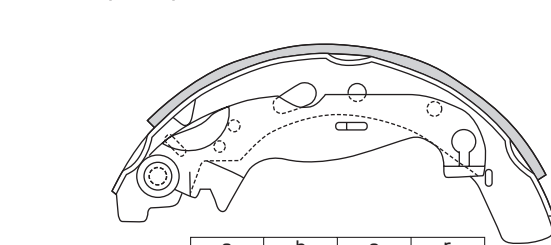

LN3432

a	b	c	r
3.2	2	30	100

1pc.

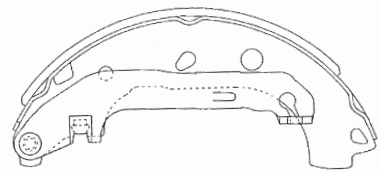

LN3428

a	b	c	r
3.5	2	40	114.3

1pc.

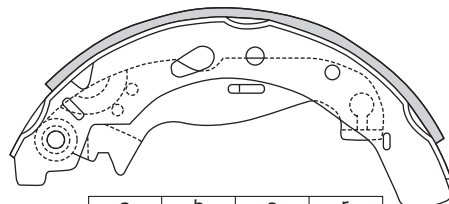

LN3433

a	b	c	r
3.2	2	30	100

1pc.

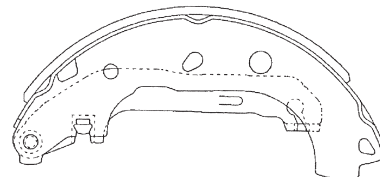

LN3429

a	b	c	r
3.5	2	40	114.3

1pc.

FN-3434

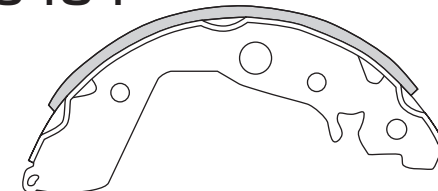

LN3434

(Rear)

a	b	c	r
3.2	1.6	25	90

2pcs.

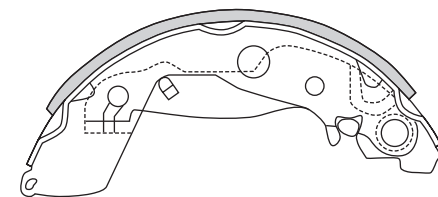

LN3435

a	b	c	r
3.2	1.6	25	90

1pc.

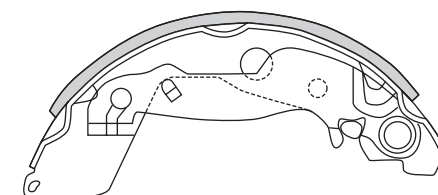





LN3436



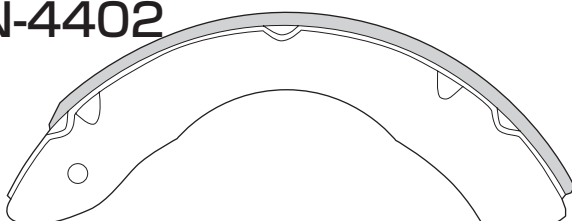

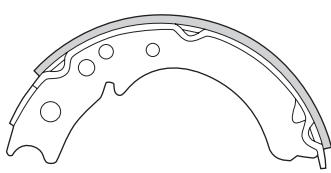
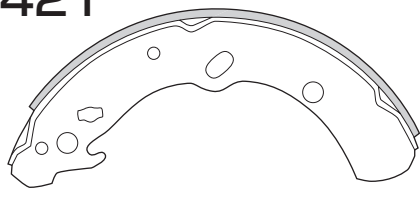
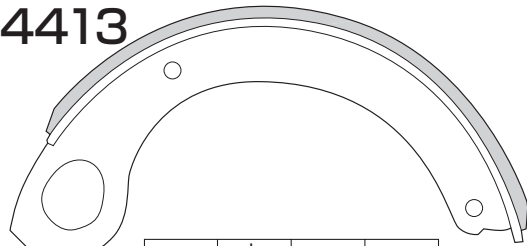
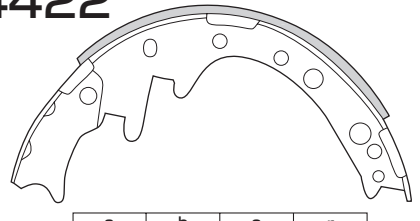
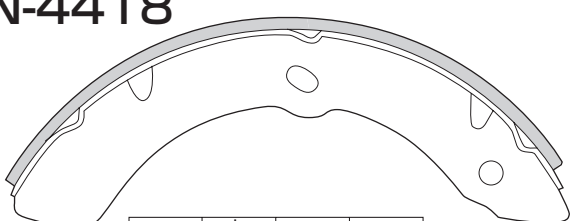
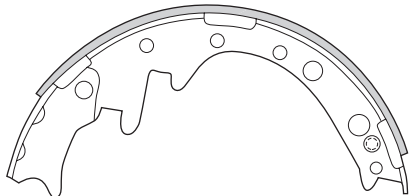
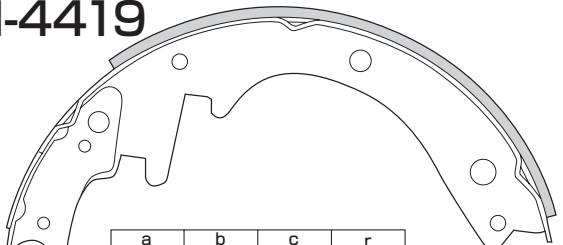
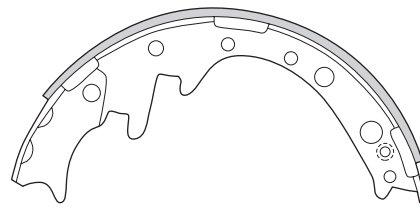
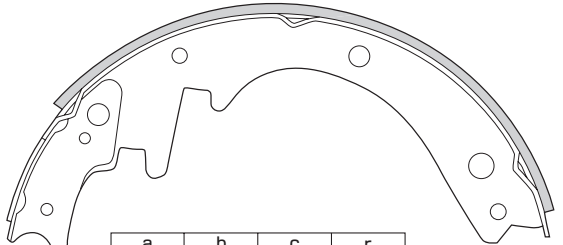
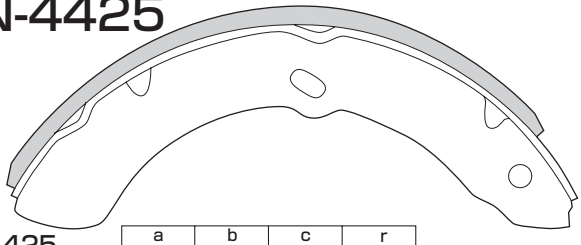

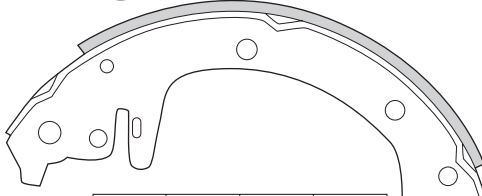
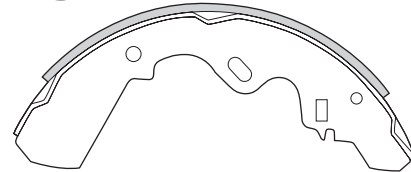
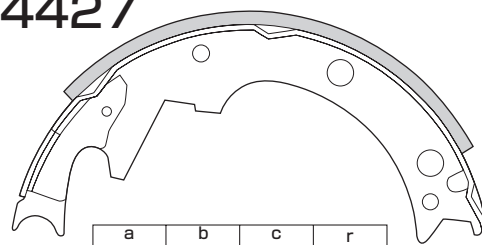
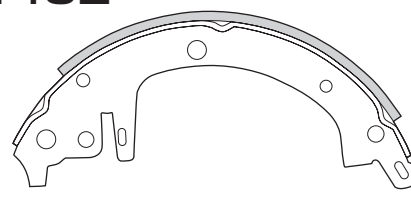
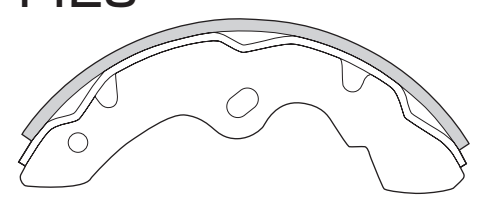
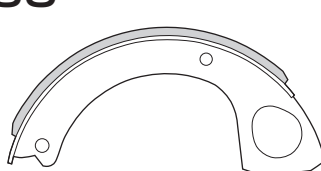
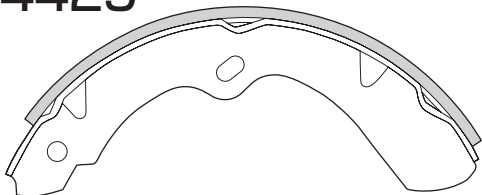
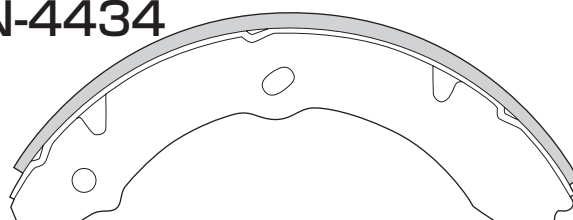
a	b	c	r
3.2	1.6	25	90

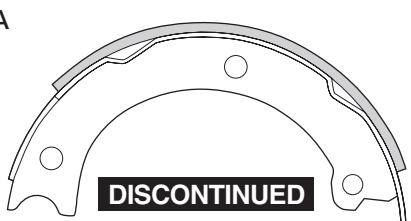

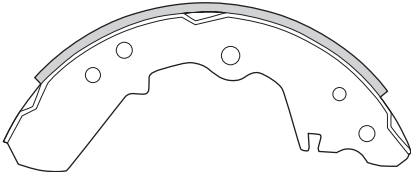
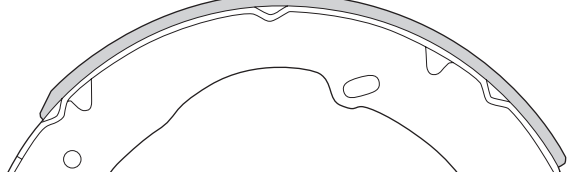
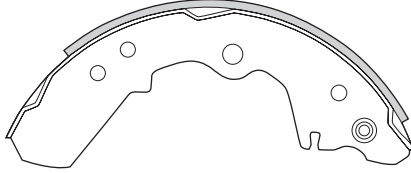
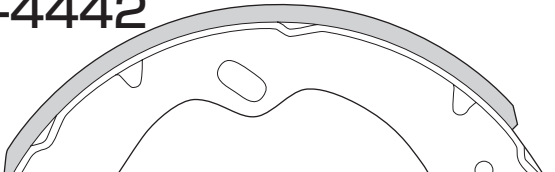
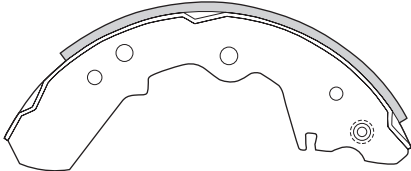
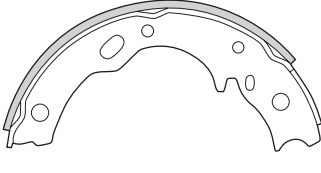
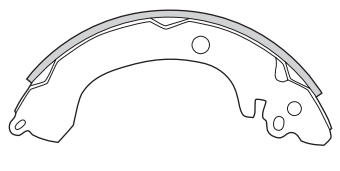

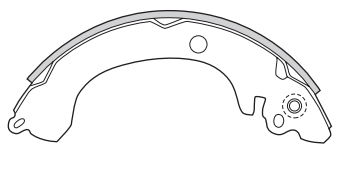
1pc.

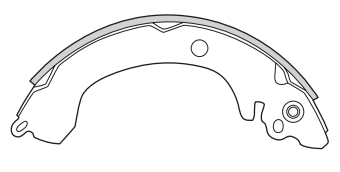
New Products

<p>FN-4402</p>  <p>LN4402 (Front & Rear)</p> <table border="1" data-bbox="412 531 713 584"> <thead> <tr> <th>a</th> <th>b</th> <th>c</th> <th>r</th> </tr> </thead> <tbody> <tr> <td>6</td> <td>2.3</td> <td>55</td> <td>150</td> </tr> </tbody> </table> <p>4pcs.</p>	a	b	c	r	6	2.3	55	150	<p>FN-4420</p>  <p>DISCONTINUED</p> <p>LN4420 (Parking)</p> <table border="1" data-bbox="1089 531 1390 584"> <thead> <tr> <th>a</th> <th>b</th> <th>c</th> <th>r</th> </tr> </thead> <tbody> <tr> <td>6</td> <td>2.3</td> <td>50</td> <td>108</td> </tr> </tbody> </table> <p>2pcs.</p>	a	b	c	r	6	2.3	50	108
a	b	c	r														
6	2.3	55	150														
a	b	c	r														
6	2.3	50	108														
<p>FN-4404</p>  <p>LN4404 (Parking)</p> <table border="1" data-bbox="412 847 713 901"> <thead> <tr> <th>a</th> <th>b</th> <th>c</th> <th>r</th> </tr> </thead> <tbody> <tr> <td>4</td> <td>2</td> <td>35</td> <td>89</td> </tr> </tbody> </table> <p>2pcs.</p>	a	b	c	r	4	2	35	89	<p>FN-4421</p>  <p>LN4421 (Front)</p> <table border="1" data-bbox="1089 847 1390 901"> <thead> <tr> <th>a</th> <th>b</th> <th>c</th> <th>r</th> </tr> </thead> <tbody> <tr> <td>4.5</td> <td>2</td> <td>50</td> <td>127</td> </tr> </tbody> </table> <p>4pcs.</p>	a	b	c	r	4.5	2	50	127
a	b	c	r														
4	2	35	89														
a	b	c	r														
4.5	2	50	127														
<p>FN-4413</p>  <p>LN4413(Parking)</p> <table border="1" data-bbox="465 1169 766 1222"> <thead> <tr> <th>a</th> <th>b</th> <th>c</th> <th>r</th> </tr> </thead> <tbody> <tr> <td>6</td> <td>4.5</td> <td>75</td> <td>152.4</td> </tr> </tbody> </table> <p>2pcs.</p>	a	b	c	r	6	4.5	75	152.4	<p>FN-4422</p>  <p>LN4422 (Rear)</p> <table border="1" data-bbox="1089 1169 1390 1222"> <thead> <tr> <th>a</th> <th>b</th> <th>c</th> <th>r</th> </tr> </thead> <tbody> <tr> <td>4.5</td> <td>2</td> <td>45</td> <td>127</td> </tr> </tbody> </table> <p>2pcs.</p>	a	b	c	r	4.5	2	45	127
a	b	c	r														
6	4.5	75	152.4														
a	b	c	r														
4.5	2	45	127														
<p>FN-4418</p>  <p>LN4418(Front)</p> <table border="1" data-bbox="412 1485 713 1539"> <thead> <tr> <th>a</th> <th>b</th> <th>c</th> <th>r</th> </tr> </thead> <tbody> <tr> <td>4.5</td> <td>2.3</td> <td>60</td> <td>139.5</td> </tr> </tbody> </table> <p>4pcs.</p>	a	b	c	r	4.5	2.3	60	139.5	<p>FN-4423</p>  <p>LN4423</p> <table border="1" data-bbox="1089 1485 1390 1539"> <thead> <tr> <th>a</th> <th>b</th> <th>c</th> <th>r</th> </tr> </thead> <tbody> <tr> <td>4.5</td> <td>2</td> <td>45</td> <td>127</td> </tr> </tbody> </table> <p>1pc.</p>	a	b	c	r	4.5	2	45	127
a	b	c	r														
4.5	2.3	60	139.5														
a	b	c	r														
4.5	2	45	127														
<p>FN-4419</p>  <p>LN4419 (Rear)</p> <table border="1" data-bbox="412 1802 713 1856"> <thead> <tr> <th>a</th> <th>b</th> <th>c</th> <th>r</th> </tr> </thead> <tbody> <tr> <td>4.5</td> <td>2.3</td> <td>60</td> <td>139.5</td> </tr> </tbody> </table> <p>2pcs.</p>	a	b	c	r	4.5	2.3	60	139.5	<p>FN-4424</p>  <p>LN4424</p> <table border="1" data-bbox="1089 1802 1390 1856"> <thead> <tr> <th>a</th> <th>b</th> <th>c</th> <th>r</th> </tr> </thead> <tbody> <tr> <td>4.5</td> <td>2</td> <td>45</td> <td>127</td> </tr> </tbody> </table> <p>1pc.</p>	a	b	c	r	4.5	2	45	127
a	b	c	r														
4.5	2.3	60	139.5														
a	b	c	r														
4.5	2	45	127														
<p>FN-4419A</p>  <p>LN4419A</p> <table border="1" data-bbox="412 2119 713 2172"> <thead> <tr> <th>a</th> <th>b</th> <th>c</th> <th>r</th> </tr> </thead> <tbody> <tr> <td>4.5</td> <td>2.3</td> <td>60</td> <td>139.5</td> </tr> </tbody> </table> <p>2pcs.</p>	a	b	c	r	4.5	2.3	60	139.5	<p>FN-4425</p>  <p>LN4425 (Front & Rear)</p> <table border="1" data-bbox="1089 2119 1390 2172"> <thead> <tr> <th>a</th> <th>b</th> <th>c</th> <th>r</th> </tr> </thead> <tbody> <tr> <td>6</td> <td>3.2</td> <td>75</td> <td>150</td> </tr> </tbody> </table> <p>4pcs.</p>	a	b	c	r	6	3.2	75	150
a	b	c	r														
4.5	2.3	60	139.5														
a	b	c	r														
6	3.2	75	150														

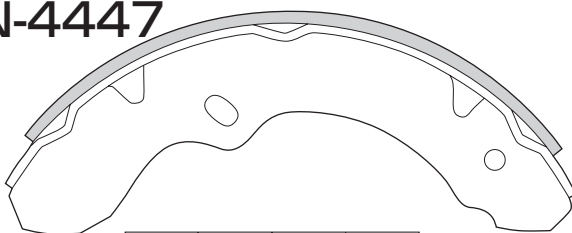
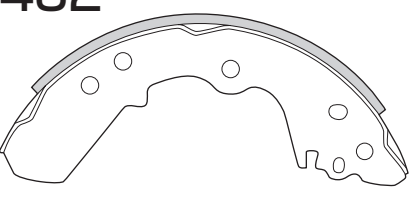
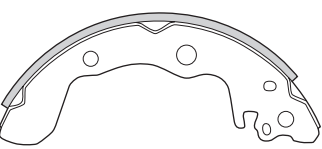
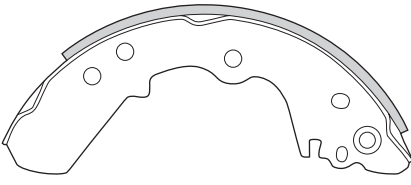
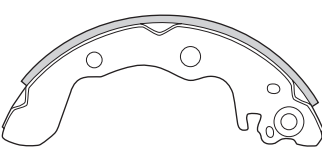
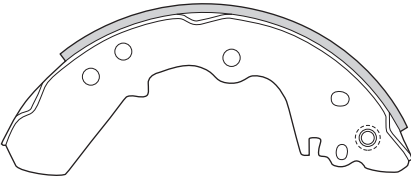
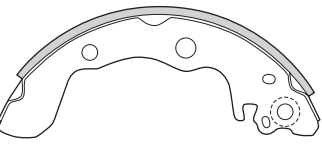
<p>FN-4426</p>  <p>LN4426(Rear)</p> <table border="1" data-bbox="412 523 707 584"> <thead> <tr> <th>a</th> <th>b</th> <th>c</th> <th>r</th> </tr> </thead> <tbody> <tr> <td>4</td> <td>2.3</td> <td>40</td> <td>114.3</td> </tr> </tbody> </table> <p>4pcs.</p>	a	b	c	r	4	2.3	40	114.3	<p>FN-4431</p>  <p>LN4431(Rear)</p> <table border="1" data-bbox="1084 523 1379 584"> <thead> <tr> <th>a</th> <th>b</th> <th>c</th> <th>r</th> </tr> </thead> <tbody> <tr> <td>4.5</td> <td>2</td> <td>50</td> <td>127</td> </tr> </tbody> </table> <p>4pcs.</p>	a	b	c	r	4.5	2	50	127
a	b	c	r														
4	2.3	40	114.3														
a	b	c	r														
4.5	2	50	127														
<p>FN-4427</p>  <p>LN4427(Rear)</p> <table border="1" data-bbox="412 852 707 913"> <thead> <tr> <th>a</th> <th>b</th> <th>c</th> <th>r</th> </tr> </thead> <tbody> <tr> <td>4.5</td> <td>2</td> <td>45</td> <td>101.6</td> </tr> </tbody> </table> <p>4pcs.</p>	a	b	c	r	4.5	2	45	101.6	<p>FN-4432</p>  <p>LN4432(Rear)</p> <table border="1" data-bbox="1084 852 1379 913"> <thead> <tr> <th>a</th> <th>b</th> <th>c</th> <th>r</th> </tr> </thead> <tbody> <tr> <td>4</td> <td>2.3</td> <td>40</td> <td>114.3</td> </tr> </tbody> </table> <p>4pcs.</p>	a	b	c	r	4	2.3	40	114.3
a	b	c	r														
4.5	2	45	101.6														
a	b	c	r														
4	2.3	40	114.3														
<p>FN-4428</p>  <p>LN4428(Rear)</p> <table border="1" data-bbox="412 1169 707 1230"> <thead> <tr> <th>a</th> <th>b</th> <th>c</th> <th>r</th> </tr> </thead> <tbody> <tr> <td>6</td> <td>3.2</td> <td>75</td> <td>114.3</td> </tr> </tbody> </table> <p>4pcs.</p>	a	b	c	r	6	3.2	75	114.3	<p>FN-4433</p>  <p>LN4433(Parking)</p> <table border="1" data-bbox="1084 1169 1379 1230"> <thead> <tr> <th>a</th> <th>b</th> <th>c</th> <th>r</th> </tr> </thead> <tbody> <tr> <td>6</td> <td>2.3</td> <td>50</td> <td>108</td> </tr> </tbody> </table> <p>2pcs.</p>	a	b	c	r	6	2.3	50	108
a	b	c	r														
6	3.2	75	114.3														
a	b	c	r														
6	2.3	50	108														
<p>FN-4429</p>  <p>LN4429 (Front & Rear)</p> <table border="1" data-bbox="412 1485 707 1546"> <thead> <tr> <th>a</th> <th>b</th> <th>c</th> <th>r</th> </tr> </thead> <tbody> <tr> <td>6</td> <td>3.2</td> <td>75</td> <td>150</td> </tr> </tbody> </table> <p>4pcs.</p>	a	b	c	r	6	3.2	75	150	<p>FN-4434</p>  <p>LN4434 (Front & Rear)</p> <table border="1" data-bbox="1084 1485 1379 1546"> <thead> <tr> <th>a</th> <th>b</th> <th>c</th> <th>r</th> </tr> </thead> <tbody> <tr> <td>4.5</td> <td>2.9</td> <td>60</td> <td>139.7</td> </tr> </tbody> </table> <p>4pcs.</p>	a	b	c	r	4.5	2.9	60	139.7
a	b	c	r														
6	3.2	75	150														
a	b	c	r														
4.5	2.9	60	139.7														
<p>FN-4430</p>  <p>LN4430 (Parking)</p> <table border="1" data-bbox="412 1802 707 1863"> <thead> <tr> <th>a</th> <th>b</th> <th>c</th> <th>r</th> </tr> </thead> <tbody> <tr> <td>4</td> <td>1.6</td> <td>30</td> <td>80</td> </tr> </tbody> </table> <p>1 pc.</p>	a	b	c	r	4	1.6	30	80									
a	b	c	r														
4	1.6	30	80														
<p>LN4430A</p>  <table border="1" data-bbox="412 2119 707 2180"> <thead> <tr> <th>a</th> <th>b</th> <th>c</th> <th>r</th> </tr> </thead> <tbody> <tr> <td>4</td> <td>1.6</td> <td>30</td> <td>80</td> </tr> </tbody> </table> <p>1 pc.</p>	a	b	c	r	4	1.6	30	80									
a	b	c	r														
4	1.6	30	80														

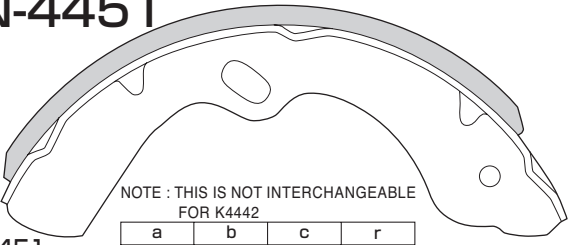
<h3>FN-4435</h3>  <table border="1" data-bbox="421 531 716 584"> <tr><th>a</th><th>b</th><th>c</th><th>r</th></tr> <tr><td>3.2</td><td>2</td><td>50</td><td>127</td></tr> </table> <p>LN4435 (Rear) 2pcs.</p>	a	b	c	r	3.2	2	50	127	<h3>FN-4441</h3>  <table border="1" data-bbox="1084 531 1379 584"> <tr><th>a</th><th>b</th><th>c</th><th>r</th></tr> <tr><td>6</td><td>2.3</td><td>55</td><td>150</td></tr> </table> <p>LN4441(Rear) 4pcs.</p>	a	b	c	r	6	2.3	55	150
a	b	c	r														
3.2	2	50	127														
a	b	c	r														
6	2.3	55	150														
 <table border="1" data-bbox="421 847 716 901"> <tr><th>a</th><th>b</th><th>c</th><th>r</th></tr> <tr><td>3.2</td><td>2</td><td>50</td><td>127</td></tr> </table> <p>LN4436 1pc.</p>	a	b	c	r	3.2	2	50	127	<h3>FN-4442</h3>  <p>NOTE : THIS IS NOT INTERCHANGEABLE FOR K4451</p> <table border="1" data-bbox="1084 847 1379 901"> <tr><th>a</th><th>b</th><th>c</th><th>r</th></tr> <tr><td>6</td><td>3.2</td><td>75</td><td>160</td></tr> </table> <p>LN4442 (Front & Rear) 4pcs.</p>	a	b	c	r	6	3.2	75	160
a	b	c	r														
3.2	2	50	127														
a	b	c	r														
6	3.2	75	160														
 <table border="1" data-bbox="421 1164 716 1218"> <tr><th>a</th><th>b</th><th>c</th><th>r</th></tr> <tr><td>3.2</td><td>2</td><td>50</td><td>127</td></tr> </table> <p>LN4437 1pc.</p>	a	b	c	r	3.2	2	50	127	<h3>FN-4443</h3>  <table border="1" data-bbox="1084 1169 1379 1222"> <tr><th>a</th><th>b</th><th>c</th><th>r</th></tr> <tr><td>4.5</td><td>2</td><td>45</td><td>95</td></tr> </table> <p>LN4443(Parking) 2pcs.</p>	a	b	c	r	4.5	2	45	95
a	b	c	r														
3.2	2	50	127														
a	b	c	r														
4.5	2	45	95														
<h3>FN-4438</h3>  <table border="1" data-bbox="421 1485 716 1539"> <tr><th>a</th><th>b</th><th>c</th><th>r</th></tr> <tr><td>3.1</td><td>1.6</td><td>35</td><td>101.6</td></tr> </table> <p>LN4438 (Rear) 2pcs.</p>	a	b	c	r	3.1	1.6	35	101.6	<h3>FN-4444</h3>  <p>DISCONTINUED</p> <table border="1" data-bbox="1084 1485 1379 1539"> <tr><th>a</th><th>b</th><th>c</th><th>r</th></tr> <tr><td>2.9</td><td>1.6</td><td>25</td><td>90</td></tr> </table> <p>LN4444 (Rear) 2pcs.</p>	a	b	c	r	2.9	1.6	25	90
a	b	c	r														
3.1	1.6	35	101.6														
a	b	c	r														
2.9	1.6	25	90														
 <table border="1" data-bbox="421 1802 716 1856"> <tr><th>a</th><th>b</th><th>c</th><th>r</th></tr> <tr><td>3.2</td><td>1.6</td><td>35</td><td>101.6</td></tr> </table> <p>LN4439 1pc.</p>	a	b	c	r	3.2	1.6	35	101.6	 <p>DISCONTINUED</p> <table border="1" data-bbox="1084 1802 1379 1856"> <tr><th>a</th><th>b</th><th>c</th><th>r</th></tr> <tr><td>2.9</td><td>1.6</td><td>25</td><td>90</td></tr> </table> <p>LN4445 1pc.</p>	a	b	c	r	2.9	1.6	25	90
a	b	c	r														
3.2	1.6	35	101.6														
a	b	c	r														
2.9	1.6	25	90														
 <table border="1" data-bbox="421 2119 716 2172"> <tr><th>a</th><th>b</th><th>c</th><th>r</th></tr> <tr><td>3.2</td><td>1.6</td><td>35</td><td>101.6</td></tr> </table> <p>LN4440 1pc.</p>	a	b	c	r	3.2	1.6	35	101.6	 <p>DISCONTINUED</p> <table border="1" data-bbox="1084 2119 1379 2172"> <tr><th>a</th><th>b</th><th>c</th><th>r</th></tr> <tr><td>2.9</td><td>1.6</td><td>25</td><td>90</td></tr> </table> <p>LN4446 1pc.</p>	a	b	c	r	2.9	1.6	25	90
a	b	c	r														
3.2	1.6	35	101.6														
a	b	c	r														
2.9	1.6	25	90														

<h3>FN-4447</h3>  <p>LN4447 (Front & Rear)</p> <table border="1" data-bbox="421 531 716 584"> <tr><th>a</th><th>b</th><th>c</th><th>r</th></tr> <tr><td>5</td><td>3.2</td><td>90</td><td>130</td></tr> </table> <p>4pcs.</p>	a	b	c	r	5	3.2	90	130	<h3>FN-4452</h3>  <p>LN4452 (Rear)</p> <table border="1" data-bbox="1093 531 1388 584"> <tr><th>a</th><th>b</th><th>c</th><th>r</th></tr> <tr><td>3.2</td><td>2</td><td>50</td><td>127</td></tr> </table> <p>2pcs.</p>	a	b	c	r	3.2	2	50	127
a	b	c	r														
5	3.2	90	130														
a	b	c	r														
3.2	2	50	127														
<h3>FN-4448</h3>  <p>LN4448 (Rear)</p> <table border="1" data-bbox="421 847 713 901"> <tr><th>a</th><th>b</th><th>c</th><th>r</th></tr> <tr><td>2.9</td><td>1.6</td><td>25</td><td>90</td></tr> </table> <p>2pcs.</p>	a	b	c	r	2.9	1.6	25	90	 <p>LN4453</p> <table border="1" data-bbox="1093 847 1388 901"> <tr><th>a</th><th>b</th><th>c</th><th>r</th></tr> <tr><td>3.2</td><td>2</td><td>50</td><td>127</td></tr> </table> <p>1pc.</p>	a	b	c	r	3.2	2	50	127
a	b	c	r														
2.9	1.6	25	90														
a	b	c	r														
3.2	2	50	127														
 <p>LN4449</p> <table border="1" data-bbox="421 1164 713 1218"> <tr><th>a</th><th>b</th><th>c</th><th>r</th></tr> <tr><td>2.9</td><td>1.6</td><td>25</td><td>90</td></tr> </table> <p>1pc.</p>	a	b	c	r	2.9	1.6	25	90	 <p>LN4454</p> <table border="1" data-bbox="1093 1164 1388 1218"> <tr><th>a</th><th>b</th><th>c</th><th>r</th></tr> <tr><td>3.2</td><td>2</td><td>50</td><td>127</td></tr> </table> <p>1pc.</p>	a	b	c	r	3.2	2	50	127
a	b	c	r														
2.9	1.6	25	90														
a	b	c	r														
3.2	2	50	127														
 <p>LN4450</p> <table border="1" data-bbox="421 1485 713 1539"> <tr><th>a</th><th>b</th><th>c</th><th>r</th></tr> <tr><td>2.9</td><td>1.6</td><td>25</td><td>90</td></tr> </table> <p>1pc.</p>	a	b	c	r	2.9	1.6	25	90	<h3>FN-4455</h3>  <p>DISCONTINUED</p> <p>LN4455 (Rear)</p> <table border="1" data-bbox="1093 1485 1388 1539"> <tr><th>a</th><th>b</th><th>c</th><th>r</th></tr> <tr><td>3.2</td><td>1.6</td><td>25</td><td>100</td></tr> </table> <p>2pcs.</p>	a	b	c	r	3.2	1.6	25	100
a	b	c	r														
2.9	1.6	25	90														
a	b	c	r														
3.2	1.6	25	100														
<h3>FN-4451</h3>  <p>NOTE : THIS IS NOT INTERCHANGEABLE FOR K4442</p> <p>LN4451 (Front & Rear)</p> <table border="1" data-bbox="421 1814 716 1868"> <tr><th>a</th><th>b</th><th>c</th><th>r</th></tr> <tr><td>6</td><td>3.5</td><td>75</td><td>160</td></tr> </table> <p>4pcs.</p>	a	b	c	r	6	3.5	75	160	<p>DISCONTINUED</p>  <p>LN4456</p> <table border="1" data-bbox="1093 1814 1388 1868"> <tr><th>a</th><th>b</th><th>c</th><th>r</th></tr> <tr><td>3.2</td><td>1.6</td><td>25</td><td>100</td></tr> </table> <p>1pc.</p>	a	b	c	r	3.2	1.6	25	100
a	b	c	r														
6	3.5	75	160														
a	b	c	r														
3.2	1.6	25	100														
	 <p>DISCONTINUED</p> <p>LN4457</p> <table border="1" data-bbox="1093 2131 1388 2185"> <tr><th>a</th><th>b</th><th>c</th><th>r</th></tr> <tr><td>3.2</td><td>1.6</td><td>25</td><td>100</td></tr> </table> <p>1pc.</p>	a	b	c	r	3.2	1.6	25	100								
a	b	c	r														
3.2	1.6	25	100														

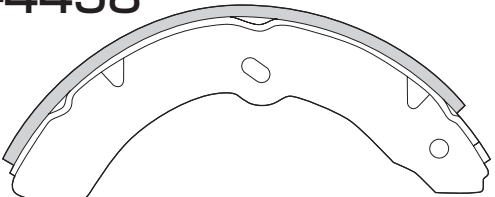
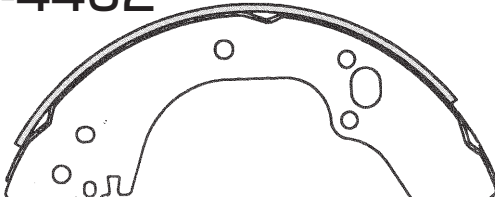
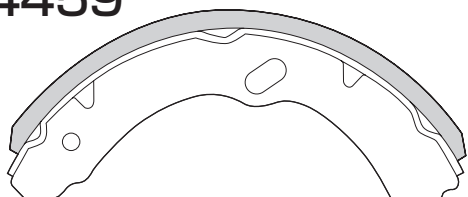
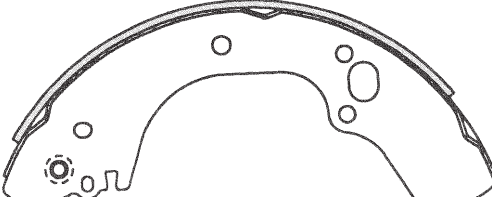
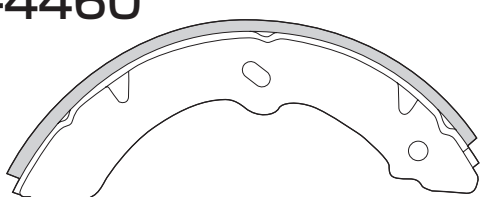
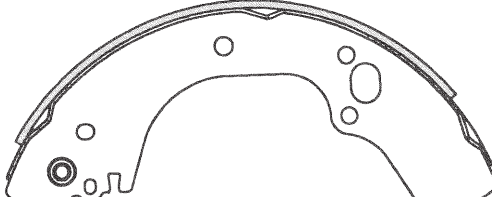
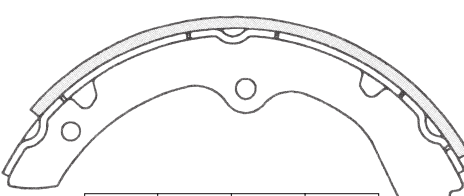
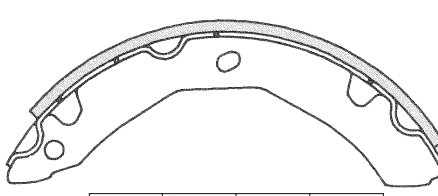
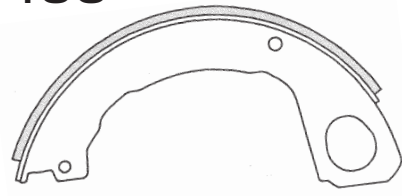
<p>FN-4458</p>  <p>LN4458 (Front & Rear)</p> <table border="1" data-bbox="421 531 716 584"> <thead> <tr> <th>a</th> <th>b</th> <th>c</th> <th>r</th> </tr> </thead> <tbody> <tr> <td>6</td> <td>3.2</td> <td>75</td> <td>150</td> </tr> </tbody> </table> <p>4pcs.</p>	a	b	c	r	6	3.2	75	150	<p>FN-4462</p>  <p>LN4462 (Rear)</p> <table border="1" data-bbox="1084 531 1379 584"> <thead> <tr> <th>a</th> <th>b</th> <th>c</th> <th>r</th> </tr> </thead> <tbody> <tr> <td>3.2</td> <td>2</td> <td>45</td> <td>147.5</td> </tr> </tbody> </table> <p>2pcs.</p>	a	b	c	r	3.2	2	45	147.5
a	b	c	r														
6	3.2	75	150														
a	b	c	r														
3.2	2	45	147.5														
<p>FN-4459</p>  <p>LN4459 (Front & Rear)</p> <table border="1" data-bbox="421 847 716 901"> <thead> <tr> <th>a</th> <th>b</th> <th>c</th> <th>r</th> </tr> </thead> <tbody> <tr> <td>6</td> <td>3.5</td> <td>100</td> <td>160</td> </tr> </tbody> </table> <p>4pcs.</p>	a	b	c	r	6	3.5	100	160	<p>FN-4463</p>  <p>LN4463</p> <table border="1" data-bbox="1084 847 1379 901"> <thead> <tr> <th>a</th> <th>b</th> <th>c</th> <th>r</th> </tr> </thead> <tbody> <tr> <td>3.2</td> <td>2</td> <td>45</td> <td>147.5</td> </tr> </tbody> </table> <p>1pc.</p>	a	b	c	r	3.2	2	45	147.5
a	b	c	r														
6	3.5	100	160														
a	b	c	r														
3.2	2	45	147.5														
<p>FN-4460</p>  <p>LN4460 (Front & Rear)</p> <table border="1" data-bbox="421 1164 716 1218"> <thead> <tr> <th>a</th> <th>b</th> <th>c</th> <th>r</th> </tr> </thead> <tbody> <tr> <td>4.5</td> <td>2.9</td> <td>60</td> <td>139.5</td> </tr> </tbody> </table> <p>4pcs.</p>	a	b	c	r	4.5	2.9	60	139.5	<p>FN-4464</p>  <p>LN4464</p> <table border="1" data-bbox="1084 1164 1379 1218"> <thead> <tr> <th>a</th> <th>b</th> <th>c</th> <th>r</th> </tr> </thead> <tbody> <tr> <td>3.2</td> <td>2</td> <td>45</td> <td>147.5</td> </tr> </tbody> </table> <p>1pc.</p>	a	b	c	r	3.2	2	45	147.5
a	b	c	r														
4.5	2.9	60	139.5														
a	b	c	r														
3.2	2	45	147.5														
<p>FN-4461</p>  <p>LN4461 (Rear)</p> <table border="1" data-bbox="421 1505 716 1559"> <thead> <tr> <th>a</th> <th>b</th> <th>c</th> <th>r</th> </tr> </thead> <tbody> <tr> <td>6</td> <td>4</td> <td>75</td> <td>145</td> </tr> </tbody> </table> <p>4pcs.</p>	a	b	c	r	6	4	75	145	<p>FN-4465</p>  <p>LN4465 (Rear)</p> <table border="1" data-bbox="1084 1505 1379 1559"> <thead> <tr> <th>a</th> <th>b</th> <th>c</th> <th>r</th> </tr> </thead> <tbody> <tr> <td>6</td> <td>2.3</td> <td>60</td> <td>120</td> </tr> </tbody> </table> <p>4pcs.</p>	a	b	c	r	6	2.3	60	120
a	b	c	r														
6	4	75	145														
a	b	c	r														
6	2.3	60	120														
	<p>FN-4466</p>  <p>LN4466 (Parking)</p> <table border="1" data-bbox="1084 1822 1379 1875"> <thead> <tr> <th>a</th> <th>b</th> <th>c</th> <th>r</th> </tr> </thead> <tbody> <tr> <td>4.5</td> <td>2.3</td> <td>50</td> <td>101.6</td> </tr> </tbody> </table> <p>2pcs.</p>	a	b	c	r	4.5	2.3	50	101.6								
a	b	c	r														
4.5	2.3	50	101.6														

FN-4467

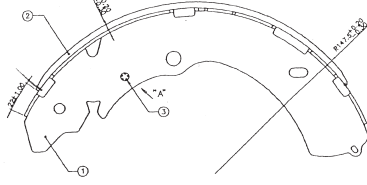

LN4467

a	b	c	r
3.6	2.3	45	147.5

1pc.

LN4468

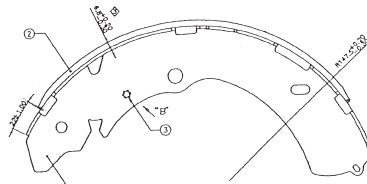

a	b	c	r
3.6	2.3	45	147.5

1pc.

LN4469

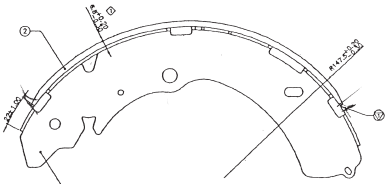

a	b	c	r
3.6	2.3	45	147.5

2pcs.

FN-4470

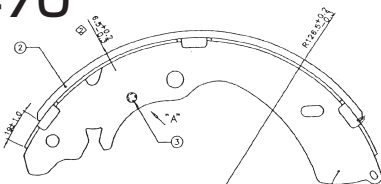

LN4470

a	b	c	r
3.2	2	50	127

1pc.

LN4471

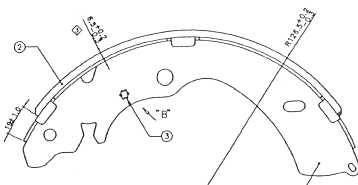

a	b	c	r
3.2	2	50	127

1pc.

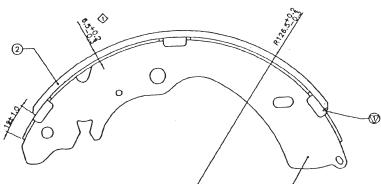

LN4472





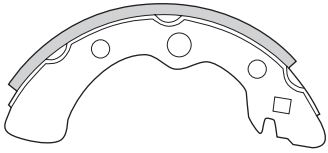
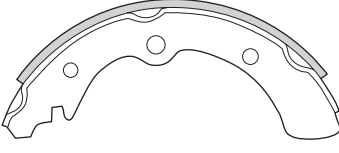

a	b	c	r
3.2	2	50	127

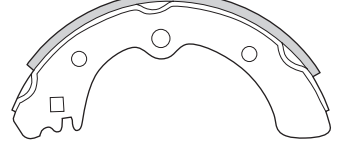
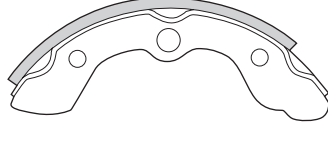
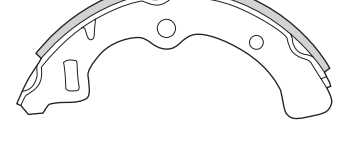
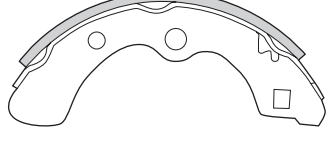
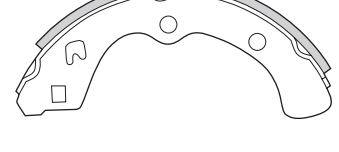
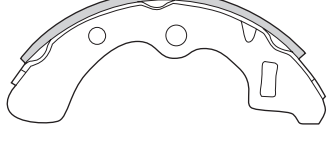
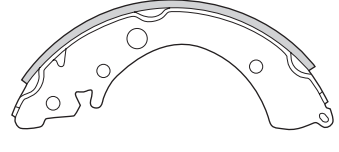
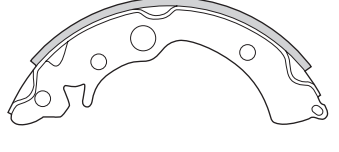
2pcs.

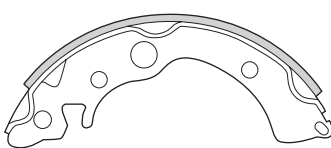
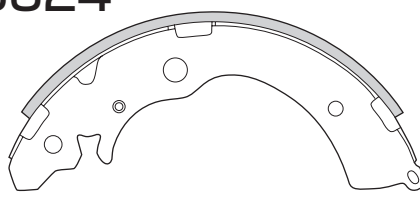
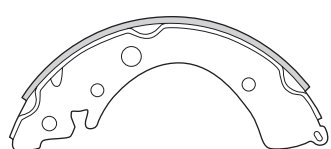
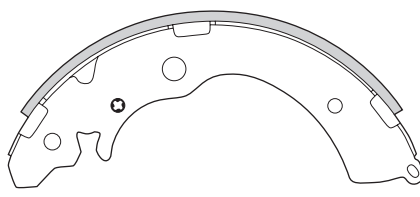
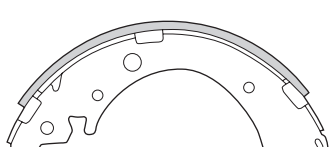
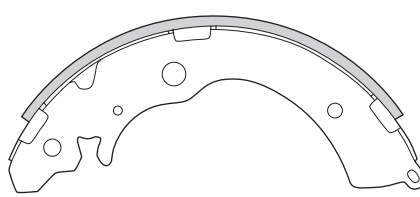
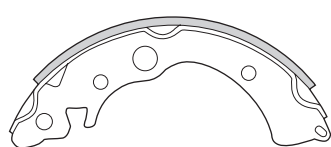
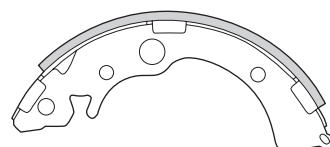
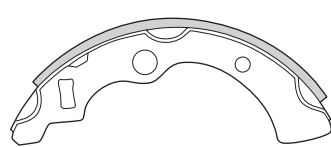
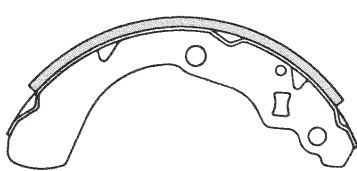
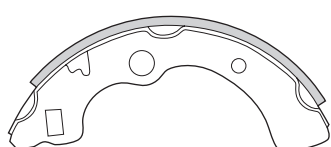
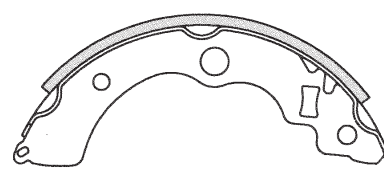
New Products

<p>FN-5504</p>  <p>LN5505(Rear)</p> <table border="1" data-bbox="415 531 713 589"> <thead> <tr> <th>a</th> <th>b</th> <th>c</th> <th>r</th> </tr> </thead> <tbody> <tr> <td>3.2</td> <td>1.6</td> <td>35</td> <td>90</td> </tr> </tbody> </table> <p>4pcs.</p>	a	b	c	r	3.2	1.6	35	90	<p>FN-5512</p>  <p>LN5512 (Rear)</p> <table border="1" data-bbox="1084 531 1381 589"> <thead> <tr> <th>a</th> <th>b</th> <th>c</th> <th>r</th> </tr> </thead> <tbody> <tr> <td>3.2</td> <td>2</td> <td>35</td> <td>100</td> </tr> </tbody> </table> <p>2pcs.</p>	a	b	c	r	3.2	2	35	100
a	b	c	r														
3.2	1.6	35	90														
a	b	c	r														
3.2	2	35	100														
<p>FN-5506</p>  <p>DISCONTINUED</p> <p>LN5506(Front)</p> <table border="1" data-bbox="415 847 713 906"> <thead> <tr> <th>a</th> <th>b</th> <th>c</th> <th>r</th> </tr> </thead> <tbody> <tr> <td>3.2</td> <td>1.6</td> <td>35</td> <td>90</td> </tr> </tbody> </table> <p>4pcs.</p>	a	b	c	r	3.2	1.6	35	90	<p>LN5513</p>  <table border="1" data-bbox="1084 847 1381 906"> <thead> <tr> <th>a</th> <th>b</th> <th>c</th> <th>r</th> </tr> </thead> <tbody> <tr> <td>3.2</td> <td>2</td> <td>35</td> <td>100</td> </tr> </tbody> </table> <p>2pcs.</p>	a	b	c	r	3.2	2	35	100
a	b	c	r														
3.2	1.6	35	90														
a	b	c	r														
3.2	2	35	100														
<p>FN-5509</p>  <p>LN5509(Front)</p> <table border="1" data-bbox="415 1188 713 1247"> <thead> <tr> <th>a</th> <th>b</th> <th>c</th> <th>r</th> </tr> </thead> <tbody> <tr> <td>3.2</td> <td>2</td> <td>35</td> <td>90</td> </tr> </tbody> </table> <p>4pcs.</p>	a	b	c	r	3.2	2	35	90	<p>FN-5514</p>  <p>LN5514 (Rear)</p> <table border="1" data-bbox="1084 1188 1381 1247"> <thead> <tr> <th>a</th> <th>b</th> <th>c</th> <th>r</th> </tr> </thead> <tbody> <tr> <td>3.2</td> <td>2</td> <td>25</td> <td>100</td> </tr> </tbody> </table> <p>2pcs.</p>	a	b	c	r	3.2	2	25	100
a	b	c	r														
3.2	2	35	90														
a	b	c	r														
3.2	2	25	100														
<p>FN-5510</p>  <p>LN5510 (Rear)</p> <table border="1" data-bbox="415 1505 713 1563"> <thead> <tr> <th>a</th> <th>b</th> <th>c</th> <th>r</th> </tr> </thead> <tbody> <tr> <td>3.2</td> <td>1.6</td> <td>25</td> <td>90</td> </tr> </tbody> </table> <p>2pcs.</p>	a	b	c	r	3.2	1.6	25	90	<p>LN5515</p>  <table border="1" data-bbox="1084 1505 1381 1563"> <thead> <tr> <th>a</th> <th>b</th> <th>c</th> <th>r</th> </tr> </thead> <tbody> <tr> <td>3.2</td> <td>2</td> <td>25</td> <td>100</td> </tr> </tbody> </table> <p>2pcs.</p>	a	b	c	r	3.2	2	25	100
a	b	c	r														
3.2	1.6	25	90														
a	b	c	r														
3.2	2	25	100														
<p>LN5511</p>  <table border="1" data-bbox="415 1822 713 1880"> <thead> <tr> <th>a</th> <th>b</th> <th>c</th> <th>r</th> </tr> </thead> <tbody> <tr> <td>3.2</td> <td>1.6</td> <td>25</td> <td>90</td> </tr> </tbody> </table> <p>2pcs.</p>	a	b	c	r	3.2	1.6	25	90	<p>FN-5516</p>  <p>LN5516(Rear)</p> <table border="1" data-bbox="1084 1822 1381 1880"> <thead> <tr> <th>a</th> <th>b</th> <th>c</th> <th>r</th> </tr> </thead> <tbody> <tr> <td>3.2</td> <td>2</td> <td>35</td> <td>100</td> </tr> </tbody> </table> <p>4pcs.</p>	a	b	c	r	3.2	2	35	100
a	b	c	r														
3.2	1.6	25	90														
a	b	c	r														
3.2	2	35	100														
	<p>FN-5517</p>  <p>LN5517(Rear)</p> <table border="1" data-bbox="1084 2143 1381 2202"> <thead> <tr> <th>a</th> <th>b</th> <th>c</th> <th>r</th> </tr> </thead> <tbody> <tr> <td>3.2</td> <td>1.6</td> <td>35</td> <td>90</td> </tr> </tbody> </table> <p>4pcs.</p>	a	b	c	r	3.2	1.6	35	90								
a	b	c	r														
3.2	1.6	35	90														

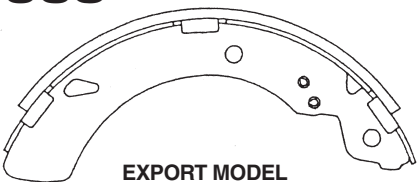
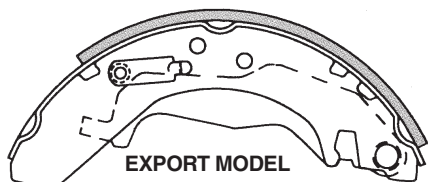
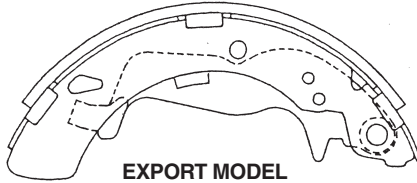
<p>FN-5518</p>  <p>LN5518(Rear)</p> <table border="1" data-bbox="412 523 707 584"> <thead> <tr> <th>a</th> <th>b</th> <th>c</th> <th>r</th> </tr> </thead> <tbody> <tr> <td>3.2</td> <td>1.6</td> <td>30</td> <td>90</td> </tr> </tbody> </table> <p>4pcs.</p>	a	b	c	r	3.2	1.6	30	90	<p>FN-5524</p>  <p>LN5524 (Rear)</p> <table border="1" data-bbox="1084 523 1379 584"> <thead> <tr> <th>a</th> <th>b</th> <th>c</th> <th>r</th> </tr> </thead> <tbody> <tr> <td>3.5</td> <td>2</td> <td>35</td> <td>110</td> </tr> </tbody> </table> <p>1pc.</p>	a	b	c	r	3.5	2	35	110
a	b	c	r														
3.2	1.6	30	90														
a	b	c	r														
3.5	2	35	110														
<p>FN-5519</p>  <p>LN5519(Rear)</p> <table border="1" data-bbox="412 840 707 901"> <thead> <tr> <th>a</th> <th>b</th> <th>c</th> <th>r</th> </tr> </thead> <tbody> <tr> <td>3.2</td> <td>2</td> <td>30</td> <td>100</td> </tr> </tbody> </table> <p>4pcs.</p>	a	b	c	r	3.2	2	30	100	<p>FN-5525</p>  <p>LN5525</p> <table border="1" data-bbox="1084 840 1379 901"> <thead> <tr> <th>a</th> <th>b</th> <th>c</th> <th>r</th> </tr> </thead> <tbody> <tr> <td>3.5</td> <td>2</td> <td>35</td> <td>110</td> </tr> </tbody> </table> <p>1pc.</p>	a	b	c	r	3.5	2	35	110
a	b	c	r														
3.2	2	30	100														
a	b	c	r														
3.5	2	35	110														
<p>FN-5520</p>  <p>LN5520(Rear)</p> <table border="1" data-bbox="412 1157 707 1218"> <thead> <tr> <th>a</th> <th>b</th> <th>c</th> <th>r</th> </tr> </thead> <tbody> <tr> <td>3.2</td> <td>2</td> <td>35</td> <td>100</td> </tr> </tbody> </table> <p>4pcs.</p>	a	b	c	r	3.2	2	35	100	<p>FN-5526</p>  <p>LN5526</p> <table border="1" data-bbox="1084 1157 1379 1218"> <thead> <tr> <th>a</th> <th>b</th> <th>c</th> <th>r</th> </tr> </thead> <tbody> <tr> <td>3.5</td> <td>2</td> <td>35</td> <td>110</td> </tr> </tbody> </table> <p>2pcs.</p>	a	b	c	r	3.5	2	35	110
a	b	c	r														
3.2	2	35	100														
a	b	c	r														
3.5	2	35	110														
<p>FN-5521</p>  <p>LN5521(Rear)</p> <table border="1" data-bbox="412 1485 707 1546"> <thead> <tr> <th>a</th> <th>b</th> <th>c</th> <th>r</th> </tr> </thead> <tbody> <tr> <td>3.2</td> <td>1.6</td> <td>25</td> <td>90</td> </tr> </tbody> </table> <p>4pcs.</p>	a	b	c	r	3.2	1.6	25	90	<p>FN-5527</p>  <p>LN5527(Rear)</p> <table border="1" data-bbox="1084 1485 1379 1546"> <thead> <tr> <th>a</th> <th>b</th> <th>c</th> <th>r</th> </tr> </thead> <tbody> <tr> <td>3.2</td> <td>1.6</td> <td>30</td> <td>90</td> </tr> </tbody> </table> <p>4pcs.</p>	a	b	c	r	3.2	1.6	30	90
a	b	c	r														
3.2	1.6	25	90														
a	b	c	r														
3.2	1.6	30	90														
<p>FN-5522</p>  <p>LN5522 (Rear)</p> <table border="1" data-bbox="412 1802 707 1863"> <thead> <tr> <th>a</th> <th>b</th> <th>c</th> <th>r</th> </tr> </thead> <tbody> <tr> <td>3.2</td> <td>1.6</td> <td>35</td> <td>90</td> </tr> </tbody> </table> <p>2pcs.</p>	a	b	c	r	3.2	1.6	35	90	<p>FN-5528</p>  <p>LN5528(Rear)</p> <table border="1" data-bbox="1084 1802 1379 1863"> <thead> <tr> <th>a</th> <th>b</th> <th>c</th> <th>r</th> </tr> </thead> <tbody> <tr> <td>2.9</td> <td>1.6</td> <td>25</td> <td>90</td> </tr> </tbody> </table> <p>4pcs.</p>	a	b	c	r	2.9	1.6	25	90
a	b	c	r														
3.2	1.6	35	90														
a	b	c	r														
2.9	1.6	25	90														
<p>FN-5523</p>  <p>LN5523</p> <table border="1" data-bbox="412 2119 707 2180"> <thead> <tr> <th>a</th> <th>b</th> <th>c</th> <th>r</th> </tr> </thead> <tbody> <tr> <td>3.2</td> <td>1.6</td> <td>35</td> <td>90</td> </tr> </tbody> </table> <p>2pcs.</p>	a	b	c	r	3.2	1.6	35	90	<p>FN-5529</p>  <p>LN5529(Rear)</p> <table border="1" data-bbox="1084 2119 1379 2180"> <thead> <tr> <th>a</th> <th>b</th> <th>c</th> <th>r</th> </tr> </thead> <tbody> <tr> <td>3.2</td> <td>1.6</td> <td>25</td> <td>90</td> </tr> </tbody> </table> <p>4pcs.</p>	a	b	c	r	3.2	1.6	25	90
a	b	c	r														
3.2	1.6	35	90														
a	b	c	r														
3.2	1.6	25	90														

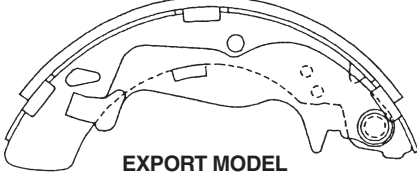
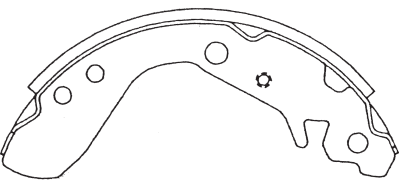
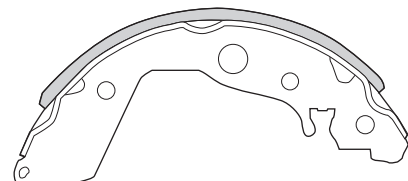
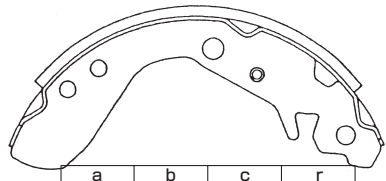
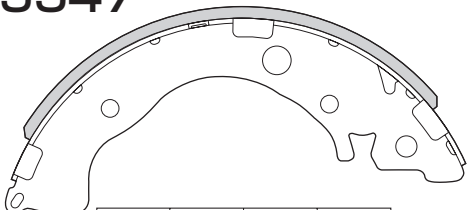
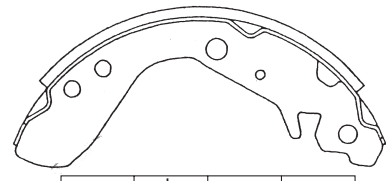
<p>FN-5530</p>  <p>EXPORT MODEL</p> <table border="1" data-bbox="413 531 713 587"> <thead> <tr> <th>a</th> <th>b</th> <th>c</th> <th>r</th> </tr> </thead> <tbody> <tr> <td>3.2</td> <td>2</td> <td>36</td> <td>101.5</td> </tr> </tbody> </table> <p>LN5530 (Rear) 2pcs.</p>	a	b	c	r	3.2	2	36	101.5	<p>FN-5538</p>  <p>EXPORT MODEL</p> <table border="1" data-bbox="1085 531 1385 587"> <thead> <tr> <th>a</th> <th>b</th> <th>c</th> <th>r</th> </tr> </thead> <tbody> <tr> <td>3.2</td> <td>2</td> <td>35</td> <td>100</td> </tr> </tbody> </table> <p>LN5538 (Rear) 2pcs.</p>	a	b	c	r	3.2	2	35	100
a	b	c	r														
3.2	2	36	101.5														
a	b	c	r														
3.2	2	35	100														
 <p>EXPORT MODEL</p> <table border="1" data-bbox="413 859 713 915"> <thead> <tr> <th>a</th> <th>b</th> <th>c</th> <th>r</th> </tr> </thead> <tbody> <tr> <td>3.2</td> <td>2</td> <td>36</td> <td>101.5</td> </tr> </tbody> </table> <p>LN5532 1pc.</p>	a	b	c	r	3.2	2	36	101.5	 <p>EXPORT MODEL</p> <table border="1" data-bbox="1085 847 1385 903"> <thead> <tr> <th>a</th> <th>b</th> <th>c</th> <th>r</th> </tr> </thead> <tbody> <tr> <td>3.2</td> <td>2</td> <td>35</td> <td>100</td> </tr> </tbody> </table> <p>LN5539 1pc.</p>	a	b	c	r	3.2	2	35	100
a	b	c	r														
3.2	2	36	101.5														
a	b	c	r														
3.2	2	35	100														
 <p>EXPORT MODEL</p> <table border="1" data-bbox="413 1176 713 1232"> <thead> <tr> <th>a</th> <th>b</th> <th>c</th> <th>r</th> </tr> </thead> <tbody> <tr> <td>3.2</td> <td>2</td> <td>36</td> <td>101.5</td> </tr> </tbody> </table> <p>LN5533 1pc.</p>	a	b	c	r	3.2	2	36	101.5	 <p>EXPORT MODEL</p> <table border="1" data-bbox="1085 1176 1385 1232"> <thead> <tr> <th>a</th> <th>b</th> <th>c</th> <th>r</th> </tr> </thead> <tbody> <tr> <td>3.2</td> <td>2</td> <td>35</td> <td>100</td> </tr> </tbody> </table> <p>LN5540 1pc.</p>	a	b	c	r	3.2	2	35	100
a	b	c	r														
3.2	2	36	101.5														
a	b	c	r														
3.2	2	35	100														
<p>FN-5534</p>  <table border="1" data-bbox="413 1503 713 1559"> <thead> <tr> <th>a</th> <th>b</th> <th>c</th> <th>r</th> </tr> </thead> <tbody> <tr> <td>2.9</td> <td>1.6</td> <td>30</td> <td>90</td> </tr> </tbody> </table> <p>LN5534 (Rear) 1pc.</p>	a	b	c	r	2.9	1.6	30	90	<p>FN-5541</p>  <table border="1" data-bbox="1085 1503 1385 1559"> <thead> <tr> <th>a</th> <th>b</th> <th>c</th> <th>r</th> </tr> </thead> <tbody> <tr> <td>2.9</td> <td>1.6</td> <td>25</td> <td>90</td> </tr> </tbody> </table> <p>LN5541 (Rear) 4pcs.</p>	a	b	c	r	2.9	1.6	25	90
a	b	c	r														
2.9	1.6	30	90														
a	b	c	r														
2.9	1.6	25	90														
 <table border="1" data-bbox="413 1819 713 1875"> <thead> <tr> <th>a</th> <th>b</th> <th>c</th> <th>r</th> </tr> </thead> <tbody> <tr> <td>2.9</td> <td>1.6</td> <td>30</td> <td>90</td> </tr> </tbody> </table> <p>LN5535 1pc.</p>	a	b	c	r	2.9	1.6	30	90	<p>FN-5547</p>  <table border="1" data-bbox="1085 1819 1385 1875"> <thead> <tr> <th>a</th> <th>b</th> <th>c</th> <th>r</th> </tr> </thead> <tbody> <tr> <td>2.9</td> <td>2.0</td> <td>30</td> <td>100</td> </tr> </tbody> </table> <p>LN5547 0pcs.</p>	a	b	c	r	2.9	2.0	30	100
a	b	c	r														
2.9	1.6	30	90														
a	b	c	r														
2.9	2.0	30	100														
 <table border="1" data-bbox="413 2136 713 2192"> <thead> <tr> <th>a</th> <th>b</th> <th>c</th> <th>r</th> </tr> </thead> <tbody> <tr> <td>2.9</td> <td>1.6</td> <td>30</td> <td>90</td> </tr> </tbody> </table> <p>LN5536 2pcs.</p>	a	b	c	r	2.9	1.6	30	90									
a	b	c	r														
2.9	1.6	30	90														

FN-5901

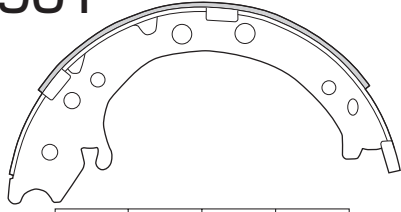







LN5901
(Parking)

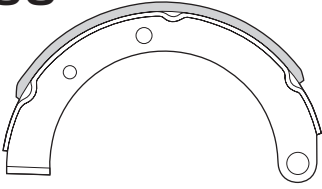
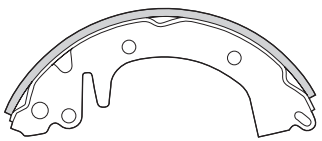
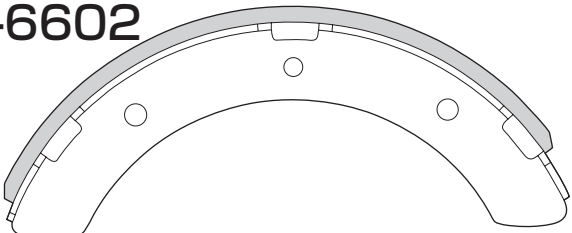

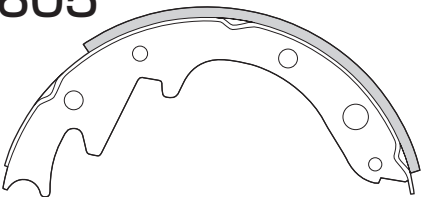
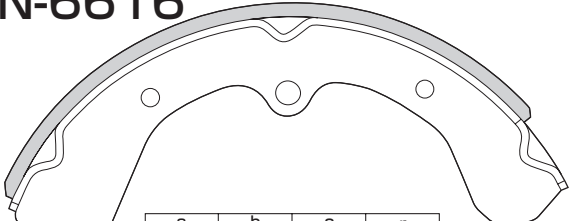
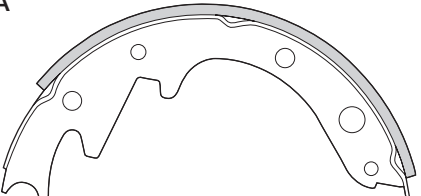
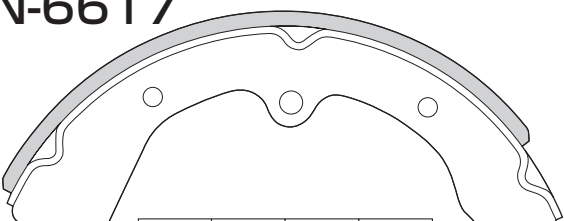
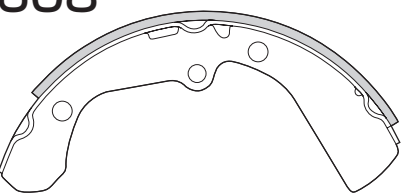
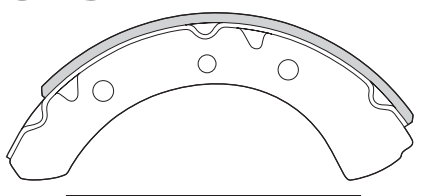
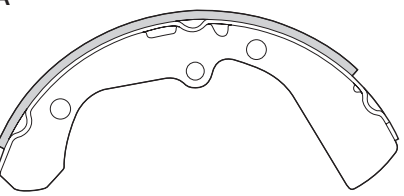
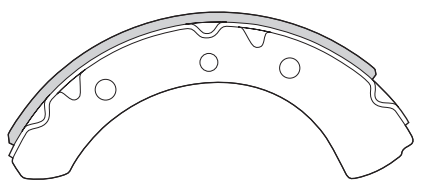

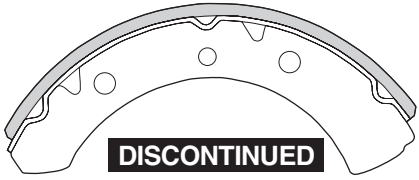
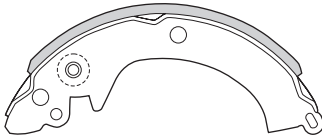
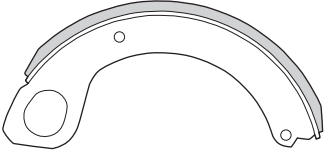
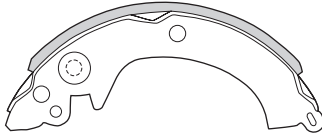
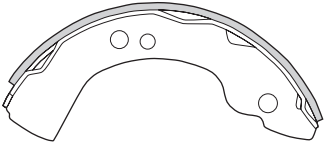
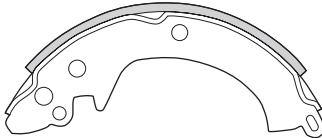
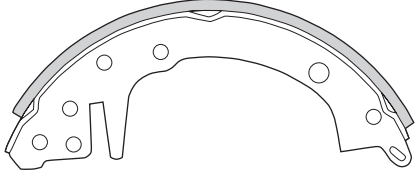
a	b	c	r
5	2	30	100

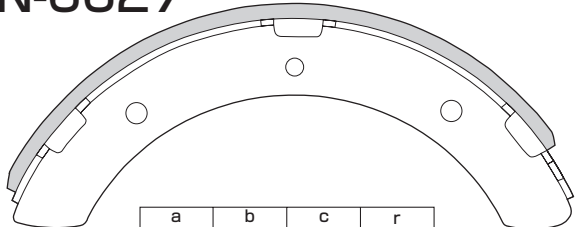

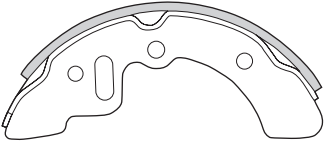

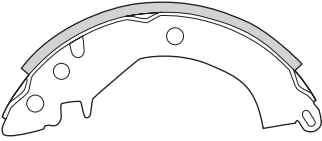
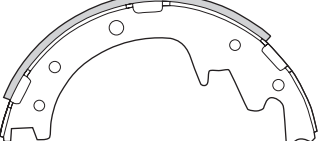
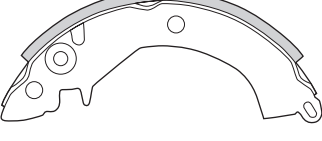
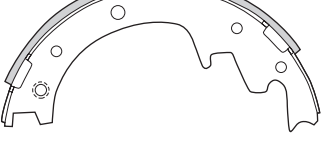
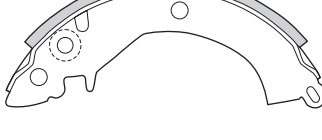
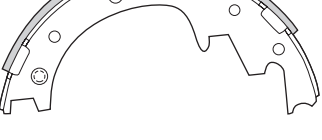
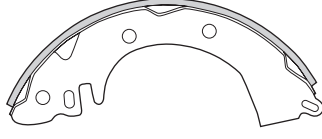
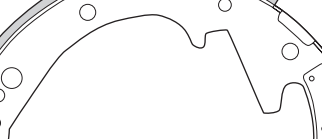
4pcs.

New Products

<p>FN-6600</p>  <p>LN6600 (Parking)</p> <table border="1" data-bbox="415 535 713 589"> <thead> <tr> <th>a</th> <th>b</th> <th>c</th> <th>r</th> </tr> </thead> <tbody> <tr> <td>3.2</td> <td>2.3</td> <td>35</td> <td>90</td> </tr> </tbody> </table> <p>2pcs.</p>	a	b	c	r	3.2	2.3	35	90	<p>FN-6609</p>  <p>LN6609(Rear)</p> <table border="1" data-bbox="1091 531 1388 584"> <thead> <tr> <th>a</th> <th>b</th> <th>c</th> <th>r</th> </tr> </thead> <tbody> <tr> <td>4</td> <td>1.6</td> <td>35</td> <td>101.6</td> </tr> </tbody> </table> <p>4pcs.</p>	a	b	c	r	4	1.6	35	101.6
a	b	c	r														
3.2	2.3	35	90														
a	b	c	r														
4	1.6	35	101.6														
<p>FN-6602</p>  <p>LN6602 (Front & Rear)</p> <table border="1" data-bbox="415 857 713 911"> <thead> <tr> <th>a</th> <th>b</th> <th>c</th> <th>r</th> </tr> </thead> <tbody> <tr> <td>4.5</td> <td>3.2</td> <td>60</td> <td>150</td> </tr> </tbody> </table> <p>4pcs.</p>	a	b	c	r	4.5	3.2	60	150	<p>FN-6612</p>  <p>LN6612(Rear)</p> <table border="1" data-bbox="1091 857 1388 911"> <thead> <tr> <th>a</th> <th>b</th> <th>c</th> <th>r</th> </tr> </thead> <tbody> <tr> <td>3.2</td> <td>1.6</td> <td>35</td> <td>90</td> </tr> </tbody> </table> <p>4pcs.</p>	a	b	c	r	3.2	1.6	35	90
a	b	c	r														
4.5	3.2	60	150														
a	b	c	r														
3.2	1.6	35	90														
<p>FN-6605</p>  <p>LN6605 (Front&Rear)</p> <table border="1" data-bbox="415 1174 713 1227"> <thead> <tr> <th>a</th> <th>b</th> <th>c</th> <th>r</th> </tr> </thead> <tbody> <tr> <td>4.5</td> <td>2</td> <td>34</td> <td>114.3</td> </tr> </tbody> </table> <p>2pcs.</p>	a	b	c	r	4.5	2	34	114.3	<p>FN-6616</p>  <p>LN6616 (Front & Rear)</p> <table border="1" data-bbox="1091 1174 1388 1227"> <thead> <tr> <th>a</th> <th>b</th> <th>c</th> <th>r</th> </tr> </thead> <tbody> <tr> <td>5</td> <td>3.2</td> <td>54</td> <td>139.7</td> </tr> </tbody> </table> <p>4pcs.</p>	a	b	c	r	5	3.2	54	139.7
a	b	c	r														
4.5	2	34	114.3														
a	b	c	r														
5	3.2	54	139.7														
<p>LN6605A</p>  <table border="1" data-bbox="415 1490 713 1544"> <thead> <tr> <th>a</th> <th>b</th> <th>c</th> <th>r</th> </tr> </thead> <tbody> <tr> <td>4.5</td> <td>2</td> <td>34</td> <td>114.3</td> </tr> </tbody> </table> <p>2pcs.</p>	a	b	c	r	4.5	2	34	114.3	<p>FN-6617</p>  <p>LN6617(Rear)</p> <table border="1" data-bbox="1091 1490 1388 1544"> <thead> <tr> <th>a</th> <th>b</th> <th>c</th> <th>r</th> </tr> </thead> <tbody> <tr> <td>5</td> <td>3.2</td> <td>54</td> <td>139.7</td> </tr> </tbody> </table> <p>4pcs.</p>	a	b	c	r	5	3.2	54	139.7
a	b	c	r														
4.5	2	34	114.3														
a	b	c	r														
5	3.2	54	139.7														
<p>FN-6608</p>  <p>LN6608 (Front)</p> <table border="1" data-bbox="415 1819 713 1873"> <thead> <tr> <th>a</th> <th>b</th> <th>c</th> <th>r</th> </tr> </thead> <tbody> <tr> <td>3.2</td> <td>2</td> <td>34</td> <td>114.3</td> </tr> </tbody> </table> <p>2pcs.</p>	a	b	c	r	3.2	2	34	114.3	<p>FN-6618A</p>  <p>LN6618 (Front)</p> <table border="1" data-bbox="1091 1819 1388 1873"> <thead> <tr> <th>a</th> <th>b</th> <th>c</th> <th>r</th> </tr> </thead> <tbody> <tr> <td>4</td> <td>2</td> <td>50</td> <td>115</td> </tr> </tbody> </table> <p>2pcs.</p>	a	b	c	r	4	2	50	115
a	b	c	r														
3.2	2	34	114.3														
a	b	c	r														
4	2	50	115														
<p>LN6608A</p>  <table border="1" data-bbox="415 2136 713 2189"> <thead> <tr> <th>a</th> <th>b</th> <th>c</th> <th>r</th> </tr> </thead> <tbody> <tr> <td>3.2</td> <td>2</td> <td>34</td> <td>114.3</td> </tr> </tbody> </table> <p>2pcs.</p>	a	b	c	r	3.2	2	34	114.3	<p>LN6618A</p>  <table border="1" data-bbox="1091 2136 1388 2189"> <thead> <tr> <th>a</th> <th>b</th> <th>c</th> <th>r</th> </tr> </thead> <tbody> <tr> <td>4</td> <td>2</td> <td>50</td> <td>115</td> </tr> </tbody> </table> <p>2pcs.</p>	a	b	c	r	4	2	50	115
a	b	c	r														
3.2	2	34	114.3														
a	b	c	r														
4	2	50	115														

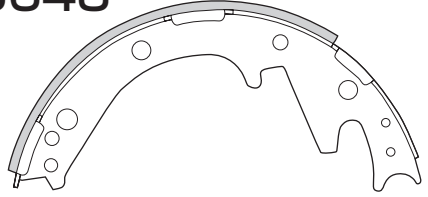
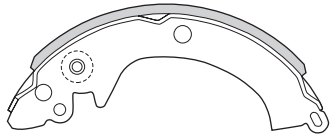
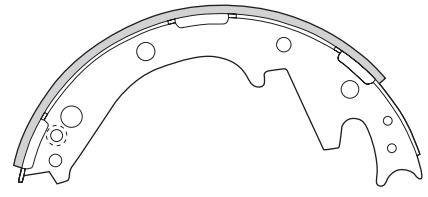
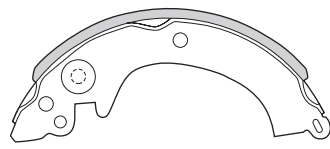
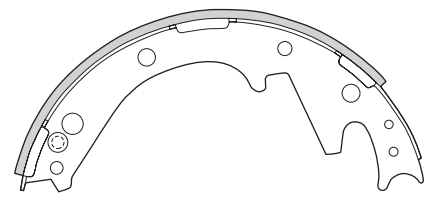
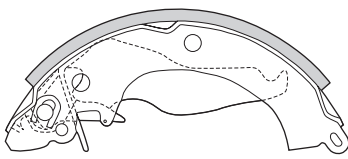
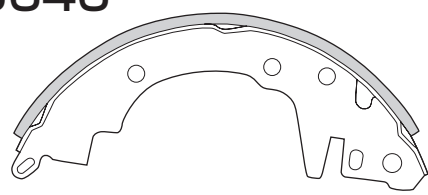
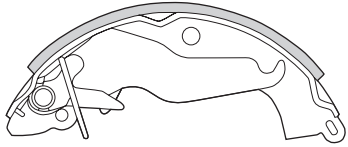

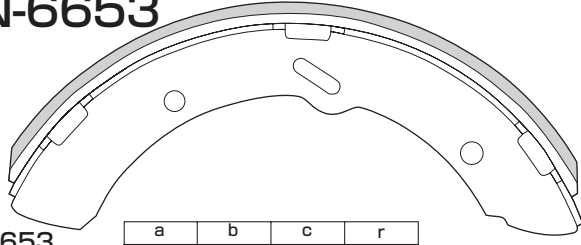
<p>FN-6618B</p>  <p>DISCONTINUED</p> <table border="1" data-bbox="413 533 711 587"> <thead> <tr> <th>a</th> <th>b</th> <th>c</th> <th>r</th> </tr> </thead> <tbody> <tr> <td>4</td> <td>2</td> <td>50</td> <td>115</td> </tr> </tbody> </table> <p>LN6618B(Rear) 4pcs.</p>	a	b	c	r	4	2	50	115	<p>FN-6629</p>  <table border="1" data-bbox="1089 533 1387 587"> <thead> <tr> <th>a</th> <th>b</th> <th>c</th> <th>r</th> </tr> </thead> <tbody> <tr> <td>3.2</td> <td>1.6</td> <td>35</td> <td>90</td> </tr> </tbody> </table> <p>LN6630 (Rear) 1pc.</p>	a	b	c	r	3.2	1.6	35	90
a	b	c	r														
4	2	50	115														
a	b	c	r														
3.2	1.6	35	90														
<p>FN-6619</p>  <table border="1" data-bbox="413 855 711 908"> <thead> <tr> <th>a</th> <th>b</th> <th>c</th> <th>r</th> </tr> </thead> <tbody> <tr> <td>4.5</td> <td>3.2</td> <td>50</td> <td>101.6</td> </tr> </tbody> </table> <p>LN6619 (Parking) 2pcs.</p>	a	b	c	r	4.5	3.2	50	101.6	 <table border="1" data-bbox="1089 855 1387 908"> <thead> <tr> <th>a</th> <th>b</th> <th>c</th> <th>r</th> </tr> </thead> <tbody> <tr> <td>3.2</td> <td>1.6</td> <td>35</td> <td>90</td> </tr> </tbody> </table> <p>LN6629 1pc.</p>	a	b	c	r	3.2	1.6	35	90
a	b	c	r														
4.5	3.2	50	101.6														
a	b	c	r														
3.2	1.6	35	90														
<p>FN-6623</p>  <table border="1" data-bbox="413 1171 711 1225"> <thead> <tr> <th>a</th> <th>b</th> <th>c</th> <th>r</th> </tr> </thead> <tbody> <tr> <td>4</td> <td>2</td> <td>45</td> <td>101.6</td> </tr> </tbody> </table> <p>LN6623(Front) 4pcs.</p>	a	b	c	r	4	2	45	101.6	 <table border="1" data-bbox="1089 1171 1387 1225"> <thead> <tr> <th>a</th> <th>b</th> <th>c</th> <th>r</th> </tr> </thead> <tbody> <tr> <td>3.2</td> <td>1.6</td> <td>35</td> <td>90</td> </tr> </tbody> </table> <p>LN6612 2pcs.</p>	a	b	c	r	3.2	1.6	35	90
a	b	c	r														
4	2	45	101.6														
a	b	c	r														
3.2	1.6	35	90														
<p>FN-6626</p>  <table border="1" data-bbox="413 1493 711 1546"> <thead> <tr> <th>a</th> <th>b</th> <th>c</th> <th>r</th> </tr> </thead> <tbody> <tr> <td>4</td> <td>2</td> <td>40</td> <td>114.3</td> </tr> </tbody> </table> <p>LN6626(Rear) 4pcs.</p>	a	b	c	r	4	2	40	114.3	<p>FN-6631</p>  <p>DISCONTINUED</p> <table border="1" data-bbox="1089 1493 1387 1546"> <thead> <tr> <th>a</th> <th>b</th> <th>c</th> <th>r</th> </tr> </thead> <tbody> <tr> <td>3.2</td> <td>2</td> <td>40</td> <td>90</td> </tr> </tbody> </table> <p>LN6631 (Front) 2pcs.</p>	a	b	c	r	3.2	2	40	90
a	b	c	r														
4	2	40	114.3														
a	b	c	r														
3.2	2	40	90														
<p>FN-6627</p>  <table border="1" data-bbox="413 1817 711 1870"> <thead> <tr> <th>a</th> <th>b</th> <th>c</th> <th>r</th> </tr> </thead> <tbody> <tr> <td>4.5</td> <td>3.2</td> <td>70</td> <td>150</td> </tr> </tbody> </table> <p>LN6627(Front) 4pcs.</p>	a	b	c	r	4.5	3.2	70	150	 <p>DISCONTINUED</p> <table border="1" data-bbox="1089 1817 1387 1870"> <thead> <tr> <th>a</th> <th>b</th> <th>c</th> <th>r</th> </tr> </thead> <tbody> <tr> <td>3.2</td> <td>2</td> <td>40</td> <td>90</td> </tr> </tbody> </table> <p>LN6632 2pcs.</p>	a	b	c	r	3.2	2	40	90
a	b	c	r														
4.5	3.2	70	150														
a	b	c	r														
3.2	2	40	90														
<p>FN-6628</p>  <table border="1" data-bbox="413 2133 711 2187"> <thead> <tr> <th>a</th> <th>b</th> <th>c</th> <th>r</th> </tr> </thead> <tbody> <tr> <td>3.2</td> <td>2</td> <td>40</td> <td>90</td> </tr> </tbody> </table> <p>LN6628(Front) 4pcs.</p>	a	b	c	r	3.2	2	40	90									
a	b	c	r														
3.2	2	40	90														

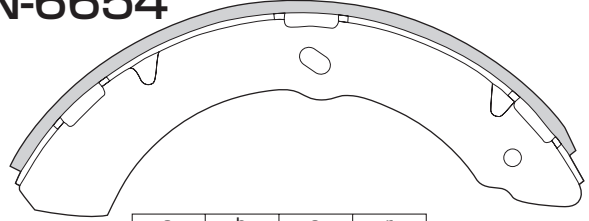
<p>FN-6633</p>  <p>LN6633 (Rear)</p> <table border="1" data-bbox="415 531 713 587"> <thead> <tr> <th>a</th> <th>b</th> <th>c</th> <th>r</th> </tr> </thead> <tbody> <tr> <td>3.2</td> <td>1.6</td> <td>35</td> <td>90</td> </tr> </tbody> </table> <p>2pcs.</p>	a	b	c	r	3.2	1.6	35	90	<p>FN-6637</p>  <p>LN6637 (Rear)</p> <table border="1" data-bbox="1091 531 1388 587"> <thead> <tr> <th>a</th> <th>b</th> <th>c</th> <th>r</th> </tr> </thead> <tbody> <tr> <td>4.5</td> <td>2</td> <td>45</td> <td>110</td> </tr> </tbody> </table> <p>2pcs.</p>	a	b	c	r	4.5	2	45	110
a	b	c	r														
3.2	1.6	35	90														
a	b	c	r														
4.5	2	45	110														
 <p>LN6634</p> <table border="1" data-bbox="415 862 713 918"> <thead> <tr> <th>a</th> <th>b</th> <th>c</th> <th>r</th> </tr> </thead> <tbody> <tr> <td>3.2</td> <td>1.6</td> <td>35</td> <td>90</td> </tr> </tbody> </table> <p>1pc.</p>	a	b	c	r	3.2	1.6	35	90	 <p>LN6638</p> <table border="1" data-bbox="1091 862 1388 918"> <thead> <tr> <th>a</th> <th>b</th> <th>c</th> <th>r</th> </tr> </thead> <tbody> <tr> <td>4.5</td> <td>2</td> <td>45</td> <td>110</td> </tr> </tbody> </table> <p>1pc.</p>	a	b	c	r	4.5	2	45	110
a	b	c	r														
3.2	1.6	35	90														
a	b	c	r														
4.5	2	45	110														
 <p>LN6635</p> <table border="1" data-bbox="415 1169 713 1225"> <thead> <tr> <th>a</th> <th>b</th> <th>c</th> <th>r</th> </tr> </thead> <tbody> <tr> <td>3.2</td> <td>1.6</td> <td>35</td> <td>90</td> </tr> </tbody> </table> <p>1pc.</p>	a	b	c	r	3.2	1.6	35	90	 <p>LN6639</p> <table border="1" data-bbox="1091 1169 1388 1225"> <thead> <tr> <th>a</th> <th>b</th> <th>c</th> <th>r</th> </tr> </thead> <tbody> <tr> <td>4.5</td> <td>2</td> <td>45</td> <td>110</td> </tr> </tbody> </table> <p>1pc.</p>	a	b	c	r	4.5	2	45	110
a	b	c	r														
3.2	1.6	35	90														
a	b	c	r														
4.5	2	45	110														
<p>FN-6636</p>  <p>LN6636(Rear)</p> <table border="1" data-bbox="415 1500 713 1556"> <thead> <tr> <th>a</th> <th>b</th> <th>c</th> <th>r</th> </tr> </thead> <tbody> <tr> <td>4</td> <td>1.6</td> <td>35</td> <td>101.6</td> </tr> </tbody> </table> <p>4pcs.</p>	a	b	c	r	4	1.6	35	101.6	<p>FN-6640</p>  <p>LN6640 (Rear)</p> <table border="1" data-bbox="1091 1500 1388 1556"> <thead> <tr> <th>a</th> <th>b</th> <th>c</th> <th>r</th> </tr> </thead> <tbody> <tr> <td>4.5</td> <td>2</td> <td>50</td> <td>120.65</td> </tr> </tbody> </table> <p>2pcs.</p>	a	b	c	r	4.5	2	50	120.65
a	b	c	r														
4	1.6	35	101.6														
a	b	c	r														
4.5	2	50	120.65														
 <p>LN6641</p> <table border="1" data-bbox="415 1831 713 1887"> <thead> <tr> <th>a</th> <th>b</th> <th>c</th> <th>r</th> </tr> </thead> <tbody> <tr> <td>4.5</td> <td>2</td> <td>50</td> <td>120.65</td> </tr> </tbody> </table> <p>1pc.</p>	a	b	c	r	4.5	2	50	120.65	 <p>LN6642</p> <table border="1" data-bbox="1091 1831 1388 1887"> <thead> <tr> <th>a</th> <th>b</th> <th>c</th> <th>r</th> </tr> </thead> <tbody> <tr> <td>4.5</td> <td>2</td> <td>50</td> <td>120.65</td> </tr> </tbody> </table> <p>1pc.</p>	a	b	c	r	4.5	2	50	120.65
a	b	c	r														
4.5	2	50	120.65														
a	b	c	r														
4.5	2	50	120.65														
 <p>LN6642</p> <table border="1" data-bbox="415 2138 713 2194"> <thead> <tr> <th>a</th> <th>b</th> <th>c</th> <th>r</th> </tr> </thead> <tbody> <tr> <td>4.5</td> <td>2</td> <td>50</td> <td>120.65</td> </tr> </tbody> </table> <p>1pc.</p>	a	b	c	r	4.5	2	50	120.65	 <p>LN6642</p> <table border="1" data-bbox="1091 2138 1388 2194"> <thead> <tr> <th>a</th> <th>b</th> <th>c</th> <th>r</th> </tr> </thead> <tbody> <tr> <td>4.5</td> <td>2</td> <td>50</td> <td>120.65</td> </tr> </tbody> </table> <p>1pc.</p>	a	b	c	r	4.5	2	50	120.65
a	b	c	r														
4.5	2	50	120.65														
a	b	c	r														
4.5	2	50	120.65														

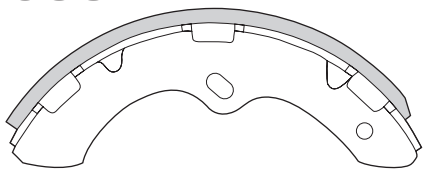
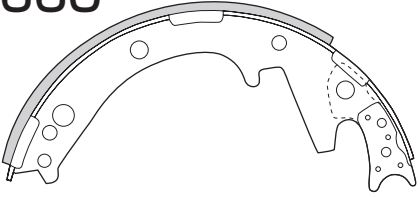
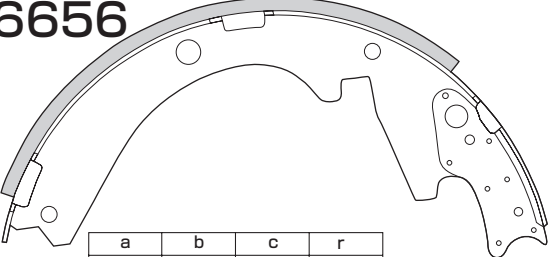
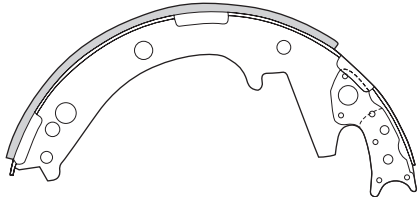
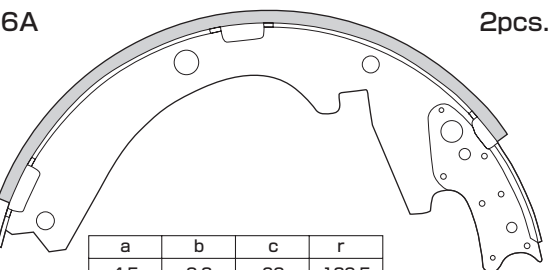
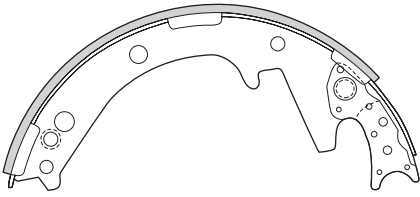
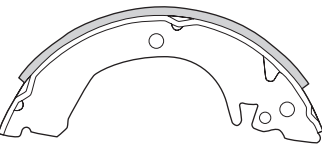
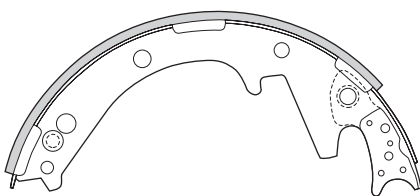
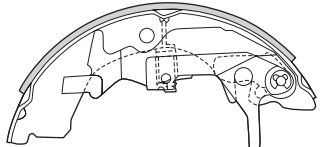
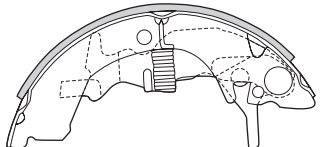
<h3>FN-6643</h3>  <p>LN6643 (Rear) <table border="1" data-bbox="421 535 716 584"><tr><th>a</th><th>b</th><th>c</th><th>r</th></tr><tr><td>4.5</td><td>2</td><td>50</td><td>120.65</td></tr></table> 2pcs.</p>	a	b	c	r	4.5	2	50	120.65	<h3>FN-6651</h3>  <p>LN6630 (Rear) <table border="1" data-bbox="1084 535 1379 584"><tr><th>a</th><th>b</th><th>c</th><th>r</th></tr><tr><td>3.2</td><td>1.6</td><td>35</td><td>90</td></tr></table> 1pc.</p>	a	b	c	r	3.2	1.6	35	90
a	b	c	r														
4.5	2	50	120.65														
a	b	c	r														
3.2	1.6	35	90														
 <p>LN6644 <table border="1" data-bbox="421 852 716 901"><tr><th>a</th><th>b</th><th>c</th><th>r</th></tr><tr><td>4.5</td><td>2</td><td>50</td><td>120.65</td></tr></table> 1pc.</p>	a	b	c	r	4.5	2	50	120.65	 <p>LN6629 <table border="1" data-bbox="1084 852 1379 901"><tr><th>a</th><th>b</th><th>c</th><th>r</th></tr><tr><td>3.2</td><td>1.6</td><td>35</td><td>90</td></tr></table> 1pc.</p>	a	b	c	r	3.2	1.6	35	90
a	b	c	r														
4.5	2	50	120.65														
a	b	c	r														
3.2	1.6	35	90														
 <p>LN6645 <table border="1" data-bbox="421 1169 716 1218"><tr><th>a</th><th>b</th><th>c</th><th>r</th></tr><tr><td>4.5</td><td>2</td><td>50</td><td>120.65</td></tr></table> 1pc.</p>	a	b	c	r	4.5	2	50	120.65	 <p>LN6651 <table border="1" data-bbox="1084 1169 1379 1218"><tr><th>a</th><th>b</th><th>c</th><th>r</th></tr><tr><td>3.2</td><td>1.6</td><td>35</td><td>90</td></tr></table> 1pc.</p>	a	b	c	r	3.2	1.6	35	90
a	b	c	r														
4.5	2	50	120.65														
a	b	c	r														
3.2	1.6	35	90														
<h3>FN-6646</h3>  <p>LN6646(Rear) <table border="1" data-bbox="421 1498 716 1546"><tr><th>a</th><th>b</th><th>c</th><th>r</th></tr><tr><td>4</td><td>2</td><td>40</td><td>114.3</td></tr></table> 4pcs.</p>	a	b	c	r	4	2	40	114.3	 <p>LN6652 <table border="1" data-bbox="1084 1498 1379 1546"><tr><th>a</th><th>b</th><th>c</th><th>r</th></tr><tr><td>3.2</td><td>1.6</td><td>35</td><td>90</td></tr></table> 1pc.</p>	a	b	c	r	3.2	1.6	35	90
a	b	c	r														
4	2	40	114.3														
a	b	c	r														
3.2	1.6	35	90														
<h3>FN-6649</h3>  <p>DISCONTINUED</p> <p>LN6649 (Front) <table border="1" data-bbox="412 1814 707 1863"><tr><th>a</th><th>b</th><th>c</th><th>r</th></tr><tr><td>4</td><td>2</td><td>44</td><td>95</td></tr></table> 2pcs.</p>	a	b	c	r	4	2	44	95	<h3>FN-6653</h3>  <p>LN6653 (Front & Rear) <table border="1" data-bbox="1084 1814 1379 1863"><tr><th>a</th><th>b</th><th>c</th><th>r</th></tr><tr><td>6</td><td>3.2</td><td>75</td><td>160</td></tr></table> 4pcs.</p>	a	b	c	r	6	3.2	75	160
a	b	c	r														
4	2	44	95														
a	b	c	r														
6	3.2	75	160														
 <p>DISCONTINUED</p> <p>LN6650 <table border="1" data-bbox="412 2131 707 2180"><tr><th>a</th><th>b</th><th>c</th><th>r</th></tr><tr><td>4</td><td>2</td><td>44</td><td>95</td></tr></table> 2pcs.</p>	a	b	c	r	4	2	44	95	<h3>FN-6654</h3>  <p>LN6654(Front) <table border="1" data-bbox="1084 2131 1379 2180"><tr><th>a</th><th>b</th><th>c</th><th>r</th></tr><tr><td>4.5</td><td>2.9</td><td>60</td><td>139.5</td></tr></table> 4pcs.</p>	a	b	c	r	4.5	2.9	60	139.5
a	b	c	r														
4	2	44	95														
a	b	c	r														
4.5	2.9	60	139.5														

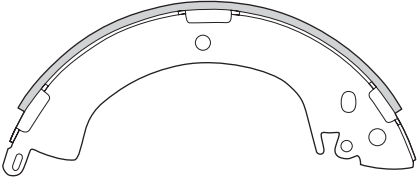
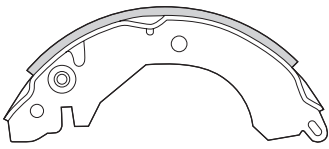
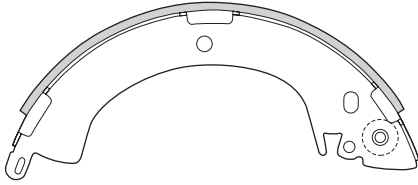
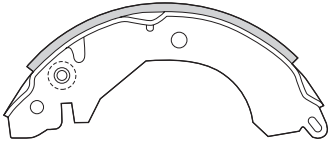
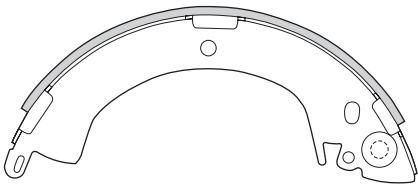
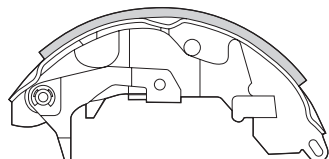
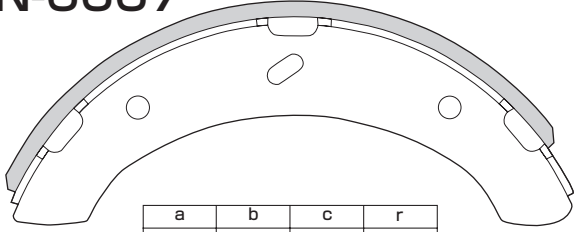
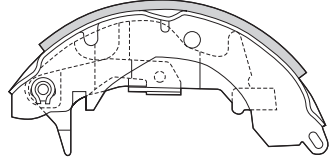
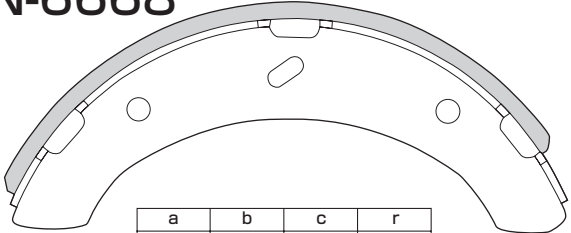
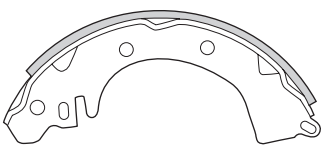
<p>FN-6655</p>  <table border="1" data-bbox="421 523 716 584"> <thead> <tr> <th>a</th> <th>b</th> <th>c</th> <th>r</th> </tr> </thead> <tbody> <tr> <td>4.5</td> <td>2.9</td> <td>60</td> <td>114.3</td> </tr> </tbody> </table> <p>LN6655 (Rear) 4pcs.</p>	a	b	c	r	4.5	2.9	60	114.3	<p>FN-6660</p>  <table border="1" data-bbox="1093 523 1388 584"> <thead> <tr> <th>a</th> <th>b</th> <th>c</th> <th>r</th> </tr> </thead> <tbody> <tr> <td>4.5</td> <td>2</td> <td>50</td> <td>120.65</td> </tr> </tbody> </table> <p>LN6660 (Rear) 1pc.</p>	a	b	c	r	4.5	2	50	120.65
a	b	c	r														
4.5	2.9	60	114.3														
a	b	c	r														
4.5	2	50	120.65														
<p>FN-6656</p>  <table border="1" data-bbox="421 840 716 901"> <thead> <tr> <th>a</th> <th>b</th> <th>c</th> <th>r</th> </tr> </thead> <tbody> <tr> <td>4.5</td> <td>2.3</td> <td>60</td> <td>139.5</td> </tr> </tbody> </table> <p>LN6656 (Rear) 2pcs.</p>	a	b	c	r	4.5	2.3	60	139.5	<p>LN6661</p>  <table border="1" data-bbox="1093 840 1388 901"> <thead> <tr> <th>a</th> <th>b</th> <th>c</th> <th>r</th> </tr> </thead> <tbody> <tr> <td>4.5</td> <td>2</td> <td>50</td> <td>120.65</td> </tr> </tbody> </table> <p>1pc.</p>	a	b	c	r	4.5	2	50	120.65
a	b	c	r														
4.5	2.3	60	139.5														
a	b	c	r														
4.5	2	50	120.65														
<p>LN6656A</p>  <table border="1" data-bbox="421 1157 716 1218"> <thead> <tr> <th>a</th> <th>b</th> <th>c</th> <th>r</th> </tr> </thead> <tbody> <tr> <td>4.5</td> <td>2.3</td> <td>60</td> <td>139.5</td> </tr> </tbody> </table> <p>2pcs.</p>	a	b	c	r	4.5	2.3	60	139.5	<p>LN6662</p>  <table border="1" data-bbox="1093 1157 1388 1218"> <thead> <tr> <th>a</th> <th>b</th> <th>c</th> <th>r</th> </tr> </thead> <tbody> <tr> <td>4.5</td> <td>2</td> <td>50</td> <td>120.65</td> </tr> </tbody> </table> <p>1pc.</p>	a	b	c	r	4.5	2	50	120.65
a	b	c	r														
4.5	2.3	60	139.5														
a	b	c	r														
4.5	2	50	120.65														
<p>FN-6657</p>  <table border="1" data-bbox="421 1473 716 1534"> <thead> <tr> <th>a</th> <th>b</th> <th>c</th> <th>r</th> </tr> </thead> <tbody> <tr> <td>4</td> <td>2</td> <td>40</td> <td>95</td> </tr> </tbody> </table> <p>LN6657 (Rear) 2pcs.</p>	a	b	c	r	4	2	40	95	<p>LN6663</p>  <table border="1" data-bbox="1093 1473 1388 1534"> <thead> <tr> <th>a</th> <th>b</th> <th>c</th> <th>r</th> </tr> </thead> <tbody> <tr> <td>4.5</td> <td>2</td> <td>50</td> <td>120.65</td> </tr> </tbody> </table> <p>1pc.</p>	a	b	c	r	4.5	2	50	120.65
a	b	c	r														
4	2	40	95														
a	b	c	r														
4.5	2	50	120.65														
<p>LN6658</p>  <table border="1" data-bbox="421 1790 716 1851"> <thead> <tr> <th>a</th> <th>b</th> <th>c</th> <th>r</th> </tr> </thead> <tbody> <tr> <td>4</td> <td>2</td> <td>40</td> <td>95</td> </tr> </tbody> </table> <p>1pc.</p>	a	b	c	r	4	2	40	95									
a	b	c	r														
4	2	40	95														
<p>LN6659</p>  <table border="1" data-bbox="421 2107 716 2168"> <thead> <tr> <th>a</th> <th>b</th> <th>c</th> <th>r</th> </tr> </thead> <tbody> <tr> <td>4</td> <td>2</td> <td>40</td> <td>95</td> </tr> </tbody> </table> <p>1pc.</p>	a	b	c	r	4	2	40	95									
a	b	c	r														
4	2	40	95														

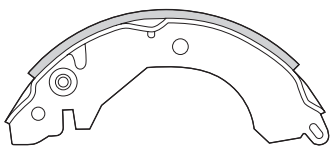
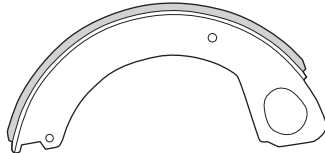
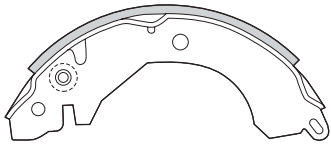
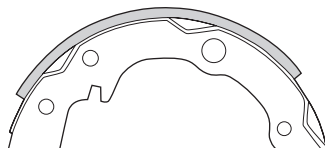
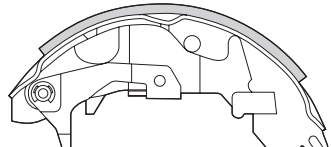
<h3>FN-6664</h3>  <p>LN6664 (Rear) <table border="1" data-bbox="415 531 713 589"><tr><th>a</th><th>b</th><th>c</th><th>r</th></tr><tr><td>4.5</td><td>2</td><td>50</td><td>127</td></tr></table> 2pcs.</p>	a	b	c	r	4.5	2	50	127	<h3>FN-6670</h3>  <p>LN6670 (Rear) <table border="1" data-bbox="1089 531 1387 589"><tr><th>a</th><th>b</th><th>c</th><th>r</th></tr><tr><td>3.2</td><td>1.6</td><td>28</td><td>90</td></tr></table> 1pc.</p>	a	b	c	r	3.2	1.6	28	90
a	b	c	r														
4.5	2	50	127														
a	b	c	r														
3.2	1.6	28	90														
 <p>LN6665 <table border="1" data-bbox="415 847 713 906"><tr><th>a</th><th>b</th><th>c</th><th>r</th></tr><tr><td>4.5</td><td>2</td><td>50</td><td>127</td></tr></table> 1pc.</p>	a	b	c	r	4.5	2	50	127	 <p>LN6671 <table border="1" data-bbox="1089 847 1387 906"><tr><th>a</th><th>b</th><th>c</th><th>r</th></tr><tr><td>3.2</td><td>1.6</td><td>28</td><td>90</td></tr></table> 1pc.</p>	a	b	c	r	3.2	1.6	28	90
a	b	c	r														
4.5	2	50	127														
a	b	c	r														
3.2	1.6	28	90														
 <p>LN6666 <table border="1" data-bbox="415 1164 713 1222"><tr><th>a</th><th>b</th><th>c</th><th>r</th></tr><tr><td>4.5</td><td>2</td><td>50</td><td>127</td></tr></table> 1pc.</p>	a	b	c	r	4.5	2	50	127	 <p>LN6672 <table border="1" data-bbox="1089 1164 1387 1222"><tr><th>a</th><th>b</th><th>c</th><th>r</th></tr><tr><td>3.2</td><td>1.6</td><td>28</td><td>90</td></tr></table> 1pc.</p>	a	b	c	r	3.2	1.6	28	90
a	b	c	r														
4.5	2	50	127														
a	b	c	r														
3.2	1.6	28	90														
<h3>FN-6667</h3>  <p>LN6667(Front) <table border="1" data-bbox="415 1490 713 1549"><tr><th>a</th><th>b</th><th>c</th><th>r</th></tr><tr><td>6</td><td>3.2</td><td>70</td><td>150</td></tr></table> 4pcs.</p>	a	b	c	r	6	3.2	70	150	 <p>LN6673 <table border="1" data-bbox="1089 1490 1387 1549"><tr><th>a</th><th>b</th><th>c</th><th>r</th></tr><tr><td>3.2</td><td>1.6</td><td>28</td><td>90</td></tr></table> 1pc.</p>	a	b	c	r	3.2	1.6	28	90
a	b	c	r														
6	3.2	70	150														
a	b	c	r														
3.2	1.6	28	90														
<h3>FN-6668</h3>  <p>LN6668(Rear) <table border="1" data-bbox="415 1807 713 1865"><tr><th>a</th><th>b</th><th>c</th><th>r</th></tr><tr><td>6</td><td>3.2</td><td>60</td><td>150</td></tr></table> 4pcs.</p>	a	b	c	r	6	3.2	60	150									
a	b	c	r														
6	3.2	60	150														
<h3>FN-6669</h3>  <p>LN6669(Rear) <table border="1" data-bbox="415 2124 713 2182"><tr><th>a</th><th>b</th><th>c</th><th>r</th></tr><tr><td>4</td><td>1.6</td><td>35</td><td>101.5</td></tr></table> 4pcs.</p>	a	b	c	r	4	1.6	35	101.5									
a	b	c	r														
4	1.6	35	101.5														

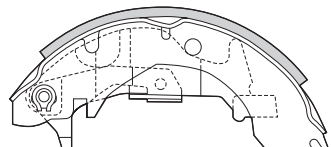
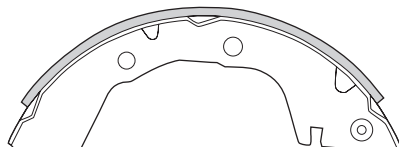
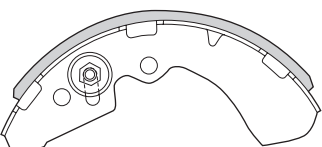
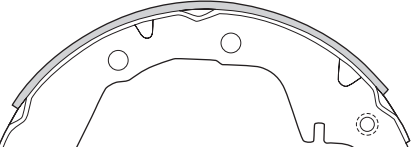
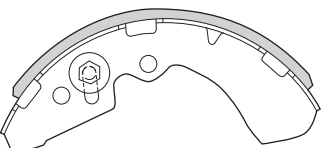
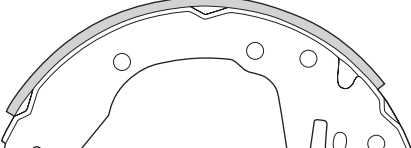
<p>FN-6674</p>  <p>LN6674 (Rear)</p> <table border="1" data-bbox="417 531 715 587"> <thead> <tr> <th>a</th> <th>b</th> <th>c</th> <th>r</th> </tr> </thead> <tbody> <tr> <td>3.2</td> <td>1.6</td> <td>35</td> <td>90</td> </tr> </tbody> </table> <p>1 pc.</p>	a	b	c	r	3.2	1.6	35	90	<p>FN-6680</p>  <p>LN6680 (Parking)</p> <table border="1" data-bbox="1085 531 1383 587"> <thead> <tr> <th>a</th> <th>b</th> <th>c</th> <th>r</th> </tr> </thead> <tbody> <tr> <td>4.5</td> <td>2.3</td> <td>50</td> <td>101.6</td> </tr> </tbody> </table> <p>2 pcs.</p>	a	b	c	r	4.5	2.3	50	101.6
a	b	c	r														
3.2	1.6	35	90														
a	b	c	r														
4.5	2.3	50	101.6														
<p>LN6675</p>  <table border="1" data-bbox="417 847 715 903"> <thead> <tr> <th>a</th> <th>b</th> <th>c</th> <th>r</th> </tr> </thead> <tbody> <tr> <td>3.2</td> <td>1.6</td> <td>35</td> <td>90</td> </tr> </tbody> </table> <p>1 pc.</p>	a	b	c	r	3.2	1.6	35	90	<p>FN-6681</p>  <p>LN6681 (Parking)</p> <table border="1" data-bbox="1085 847 1383 903"> <thead> <tr> <th>a</th> <th>b</th> <th>c</th> <th>r</th> </tr> </thead> <tbody> <tr> <td>4.5</td> <td>2</td> <td>35</td> <td>90</td> </tr> </tbody> </table> <p>2 pcs.</p>	a	b	c	r	4.5	2	35	90
a	b	c	r														
3.2	1.6	35	90														
a	b	c	r														
4.5	2	35	90														
<p>LN6676</p>  <table border="1" data-bbox="417 1164 715 1220"> <thead> <tr> <th>a</th> <th>b</th> <th>c</th> <th>r</th> </tr> </thead> <tbody> <tr> <td>3.2</td> <td>1.6</td> <td>35</td> <td>90</td> </tr> </tbody> </table> <p>1 pc.</p>	a	b	c	r	3.2	1.6	35	90	<p>FN-6682</p>  <p>DISCONTINUED</p> <p>LN6682 (Rear)</p> <table border="1" data-bbox="1085 1164 1383 1220"> <thead> <tr> <th>a</th> <th>b</th> <th>c</th> <th>r</th> </tr> </thead> <tbody> <tr> <td>3.2</td> <td>2</td> <td>40</td> <td>114.3</td> </tr> </tbody> </table> <p>2 pcs.</p>	a	b	c	r	3.2	2	40	114.3
a	b	c	r														
3.2	1.6	35	90														
a	b	c	r														
3.2	2	40	114.3														
<p>LN6677</p>  <table border="1" data-bbox="417 1481 715 1537"> <thead> <tr> <th>a</th> <th>b</th> <th>c</th> <th>r</th> </tr> </thead> <tbody> <tr> <td>3.2</td> <td>1.6</td> <td>35</td> <td>90</td> </tr> </tbody> </table> <p>1 pc.</p>	a	b	c	r	3.2	1.6	35	90	<p>LN6683</p>  <table border="1" data-bbox="1085 1481 1383 1537"> <thead> <tr> <th>a</th> <th>b</th> <th>c</th> <th>r</th> </tr> </thead> <tbody> <tr> <td>3.2</td> <td>2</td> <td>40</td> <td>114.3</td> </tr> </tbody> </table> <p>1 pc.</p>	a	b	c	r	3.2	2	40	114.3
a	b	c	r														
3.2	1.6	35	90														
a	b	c	r														
3.2	2	40	114.3														
<p>FN-6678</p>  <p>DISCONTINUED</p> <p>LN6678 (Front)</p> <table border="1" data-bbox="417 1805 715 1861"> <thead> <tr> <th>a</th> <th>b</th> <th>c</th> <th>r</th> </tr> </thead> <tbody> <tr> <td>3.2</td> <td>2</td> <td>44</td> <td>95</td> </tr> </tbody> </table> <p>2 pcs.</p>	a	b	c	r	3.2	2	44	95	<p>LN6684</p>  <table border="1" data-bbox="1085 1805 1383 1861"> <thead> <tr> <th>a</th> <th>b</th> <th>c</th> <th>r</th> </tr> </thead> <tbody> <tr> <td>3.2</td> <td>2</td> <td>40</td> <td>114.3</td> </tr> </tbody> </table> <p>1 pc.</p>	a	b	c	r	3.2	2	40	114.3
a	b	c	r														
3.2	2	44	95														
a	b	c	r														
3.2	2	40	114.3														
<p>LN6679</p>  <p>DISCONTINUED</p> <table border="1" data-bbox="417 2121 715 2177"> <thead> <tr> <th>a</th> <th>b</th> <th>c</th> <th>r</th> </tr> </thead> <tbody> <tr> <td>3.2</td> <td>2</td> <td>44</td> <td>95</td> </tr> </tbody> </table> <p>2 pcs.</p>	a	b	c	r	3.2	2	44	95	<p>FN-6685</p>  <p>LN6685(Rear)</p> <table border="1" data-bbox="1085 2121 1383 2177"> <thead> <tr> <th>a</th> <th>b</th> <th>c</th> <th>r</th> </tr> </thead> <tbody> <tr> <td>4</td> <td>2</td> <td>40</td> <td>114.3</td> </tr> </tbody> </table> <p>4 pcs.</p>	a	b	c	r	4	2	40	114.3
a	b	c	r														
3.2	2	44	95														
a	b	c	r														
4	2	40	114.3														

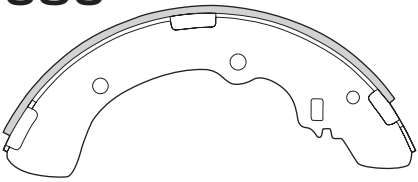
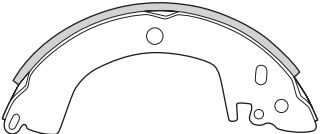
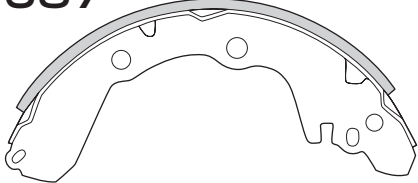
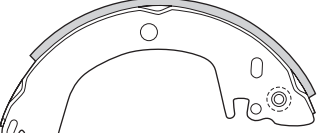
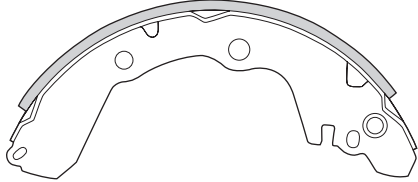
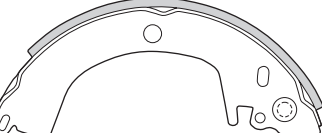
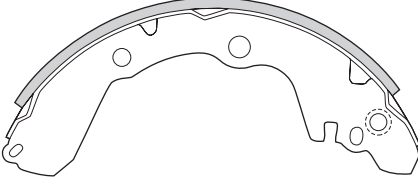
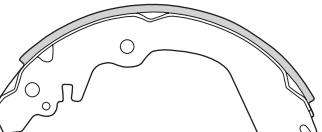
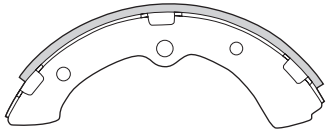
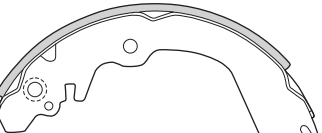
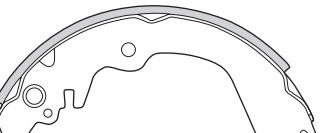
<p>FN-6686</p>  <p>LN6686(Rear)</p> <table border="1" data-bbox="419 531 716 589"> <thead> <tr> <th>a</th> <th>b</th> <th>c</th> <th>r</th> </tr> </thead> <tbody> <tr> <td>4.5</td> <td>2</td> <td>50</td> <td>127</td> </tr> </tbody> </table> <p>4pcs.</p>	a	b	c	r	4.5	2	50	127	<p>FN-6698</p>  <p>LN6698 (Rear)</p> <table border="1" data-bbox="1089 531 1387 589"> <thead> <tr> <th>a</th> <th>b</th> <th>c</th> <th>r</th> </tr> </thead> <tbody> <tr> <td>4</td> <td>2</td> <td>40</td> <td>110</td> </tr> </tbody> </table> <p>2pcs.</p>	a	b	c	r	4	2	40	110
a	b	c	r														
4.5	2	50	127														
a	b	c	r														
4	2	40	110														
<p>FN-6687</p>  <p>LN6687 (Rear)</p> <table border="1" data-bbox="419 847 716 906"> <thead> <tr> <th>a</th> <th>b</th> <th>c</th> <th>r</th> </tr> </thead> <tbody> <tr> <td>3.2</td> <td>2</td> <td>40</td> <td>114.3</td> </tr> </tbody> </table> <p>2pcs.</p>	a	b	c	r	3.2	2	40	114.3	<p>LN6699</p>  <table border="1" data-bbox="1089 847 1387 906"> <thead> <tr> <th>a</th> <th>b</th> <th>c</th> <th>r</th> </tr> </thead> <tbody> <tr> <td>4</td> <td>2</td> <td>40</td> <td>110</td> </tr> </tbody> </table> <p>1pc.</p>	a	b	c	r	4	2	40	110
a	b	c	r														
3.2	2	40	114.3														
a	b	c	r														
4	2	40	110														
<p>LN6688</p>  <table border="1" data-bbox="419 1164 716 1222"> <thead> <tr> <th>a</th> <th>b</th> <th>c</th> <th>r</th> </tr> </thead> <tbody> <tr> <td>3.2</td> <td>2</td> <td>40</td> <td>114.3</td> </tr> </tbody> </table> <p>1pc.</p>	a	b	c	r	3.2	2	40	114.3	<p>LN6700</p>  <table border="1" data-bbox="1089 1164 1387 1222"> <thead> <tr> <th>a</th> <th>b</th> <th>c</th> <th>r</th> </tr> </thead> <tbody> <tr> <td>4</td> <td>2</td> <td>40</td> <td>110</td> </tr> </tbody> </table> <p>1pc.</p>	a	b	c	r	4	2	40	110
a	b	c	r														
3.2	2	40	114.3														
a	b	c	r														
4	2	40	110														
<p>LN6689</p>  <table border="1" data-bbox="419 1485 716 1544"> <thead> <tr> <th>a</th> <th>b</th> <th>c</th> <th>r</th> </tr> </thead> <tbody> <tr> <td>3.2</td> <td>2</td> <td>40</td> <td>114.3</td> </tr> </tbody> </table> <p>1pc.</p>	a	b	c	r	3.2	2	40	114.3	<p>FN-6701</p>  <p>LN6701 (Rear)</p> <table border="1" data-bbox="1089 1485 1387 1544"> <thead> <tr> <th>a</th> <th>b</th> <th>c</th> <th>r</th> </tr> </thead> <tbody> <tr> <td>3.2</td> <td>1.6</td> <td>35</td> <td>101.5</td> </tr> </tbody> </table> <p>2pcs.</p>	a	b	c	r	3.2	1.6	35	101.5
a	b	c	r														
3.2	2	40	114.3														
a	b	c	r														
3.2	1.6	35	101.5														
<p>FN-6697</p>  <p>LN6697(Rear)</p> <table border="1" data-bbox="419 1807 716 1865"> <thead> <tr> <th>a</th> <th>b</th> <th>c</th> <th>r</th> </tr> </thead> <tbody> <tr> <td>4</td> <td>2</td> <td>40</td> <td>110</td> </tr> </tbody> </table> <p>4pcs.</p>	a	b	c	r	4	2	40	110	<p>LN6702</p>  <table border="1" data-bbox="1089 1807 1387 1865"> <thead> <tr> <th>a</th> <th>b</th> <th>c</th> <th>r</th> </tr> </thead> <tbody> <tr> <td>3.2</td> <td>1.6</td> <td>35</td> <td>101.5</td> </tr> </tbody> </table> <p>1pc.</p>	a	b	c	r	3.2	1.6	35	101.5
a	b	c	r														
4	2	40	110														
a	b	c	r														
3.2	1.6	35	101.5														
	<p>LN6703</p>  <table border="1" data-bbox="1089 2124 1387 2182"> <thead> <tr> <th>a</th> <th>b</th> <th>c</th> <th>r</th> </tr> </thead> <tbody> <tr> <td>3.2</td> <td>1.6</td> <td>35</td> <td>101.5</td> </tr> </tbody> </table> <p>1pc.</p>	a	b	c	r	3.2	1.6	35	101.5								
a	b	c	r														
3.2	1.6	35	101.5														

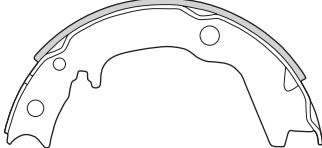
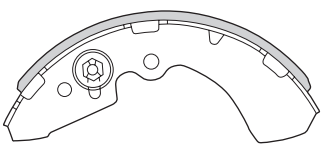
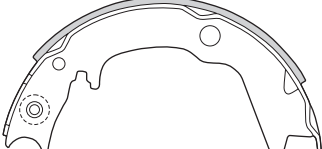
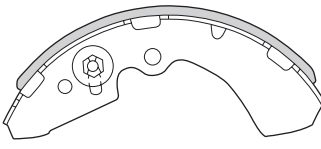
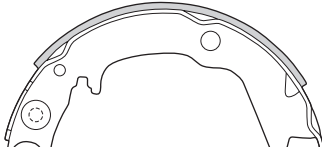
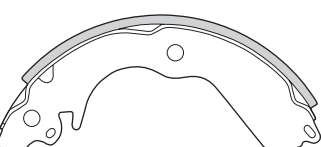
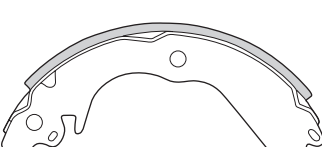
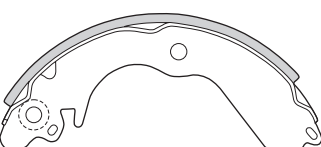
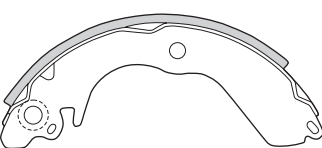
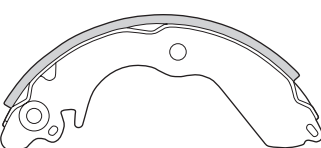
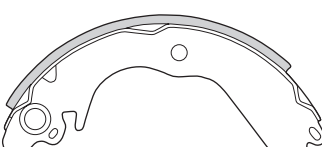
<p>FN-6704</p>  <p>LN6704 (Parking)</p> <table border="1" data-bbox="421 523 716 584"> <thead> <tr> <th>a</th> <th>b</th> <th>c</th> <th>r</th> </tr> </thead> <tbody> <tr> <td>6</td> <td>2</td> <td>30</td> <td>84</td> </tr> </tbody> </table> <p>2pcs.</p>	a	b	c	r	6	2	30	84	<p>FN-6710</p>  <p>LN6710 (Front)</p> <table border="1" data-bbox="1093 523 1388 584"> <thead> <tr> <th>a</th> <th>b</th> <th>c</th> <th>r</th> </tr> </thead> <tbody> <tr> <td>3.2</td> <td>2</td> <td>35</td> <td>95</td> </tr> </tbody> </table> <p>2pcs.</p>	a	b	c	r	3.2	2	35	95
a	b	c	r														
6	2	30	84														
a	b	c	r														
3.2	2	35	95														
 <p>LN6705</p> <table border="1" data-bbox="421 840 716 901"> <thead> <tr> <th>a</th> <th>b</th> <th>c</th> <th>r</th> </tr> </thead> <tbody> <tr> <td>6</td> <td>2</td> <td>30</td> <td>84</td> </tr> </tbody> </table> <p>1pc.</p>	a	b	c	r	6	2	30	84	 <p>LN6711</p> <table border="1" data-bbox="1093 840 1388 901"> <thead> <tr> <th>a</th> <th>b</th> <th>c</th> <th>r</th> </tr> </thead> <tbody> <tr> <td>3.2</td> <td>2</td> <td>35</td> <td>95</td> </tr> </tbody> </table> <p>2pcs.</p>	a	b	c	r	3.2	2	35	95
a	b	c	r														
6	2	30	84														
a	b	c	r														
3.2	2	35	95														
 <p>LN6706</p> <table border="1" data-bbox="421 1157 716 1218"> <thead> <tr> <th>a</th> <th>b</th> <th>c</th> <th>r</th> </tr> </thead> <tbody> <tr> <td>6</td> <td>2</td> <td>30</td> <td>84</td> </tr> </tbody> </table> <p>1pc.</p>	a	b	c	r	6	2	30	84	<p>FN-6712</p>  <p>LN6712 (Rear)</p> <table border="1" data-bbox="1093 1157 1388 1218"> <thead> <tr> <th>a</th> <th>b</th> <th>c</th> <th>r</th> </tr> </thead> <tbody> <tr> <td>2.9</td> <td>1.6</td> <td>35</td> <td>90</td> </tr> </tbody> </table> <p>2pcs.</p>	a	b	c	r	2.9	1.6	35	90
a	b	c	r														
6	2	30	84														
a	b	c	r														
2.9	1.6	35	90														
<p>FN-6707</p>  <p>LN6707 (Rear)</p> <table border="1" data-bbox="421 1473 716 1534"> <thead> <tr> <th>a</th> <th>b</th> <th>c</th> <th>r</th> </tr> </thead> <tbody> <tr> <td>2.9</td> <td>1.6</td> <td>28</td> <td>90</td> </tr> </tbody> </table> <p>2pcs.</p>	a	b	c	r	2.9	1.6	28	90	 <p>LN6713</p> <table border="1" data-bbox="1093 1473 1388 1534"> <thead> <tr> <th>a</th> <th>b</th> <th>c</th> <th>r</th> </tr> </thead> <tbody> <tr> <td>2.9</td> <td>1.6</td> <td>35</td> <td>90</td> </tr> </tbody> </table> <p>1pc.</p>	a	b	c	r	2.9	1.6	35	90
a	b	c	r														
2.9	1.6	28	90														
a	b	c	r														
2.9	1.6	35	90														
 <p>LN6708</p> <table border="1" data-bbox="421 1790 716 1851"> <thead> <tr> <th>a</th> <th>b</th> <th>c</th> <th>r</th> </tr> </thead> <tbody> <tr> <td>2.9</td> <td>1.6</td> <td>28</td> <td>90</td> </tr> </tbody> </table> <p>1pc.</p>	a	b	c	r	2.9	1.6	28	90	 <p>LN6714</p> <table border="1" data-bbox="1093 1790 1388 1851"> <thead> <tr> <th>a</th> <th>b</th> <th>c</th> <th>r</th> </tr> </thead> <tbody> <tr> <td>2.9</td> <td>1.6</td> <td>35</td> <td>90</td> </tr> </tbody> </table> <p>1pc.</p>	a	b	c	r	2.9	1.6	35	90
a	b	c	r														
2.9	1.6	28	90														
a	b	c	r														
2.9	1.6	35	90														
 <p>LN6709</p> <table border="1" data-bbox="421 2107 716 2168"> <thead> <tr> <th>a</th> <th>b</th> <th>c</th> <th>r</th> </tr> </thead> <tbody> <tr> <td>2.9</td> <td>1.6</td> <td>28</td> <td>90</td> </tr> </tbody> </table> <p>1pc.</p>	a	b	c	r	2.9	1.6	28	90									
a	b	c	r														
2.9	1.6	28	90														

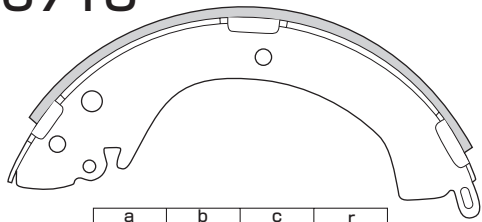
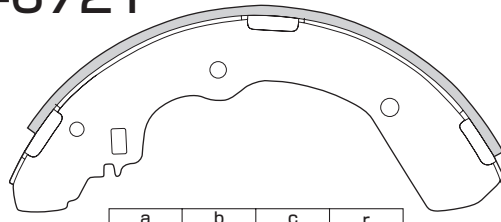
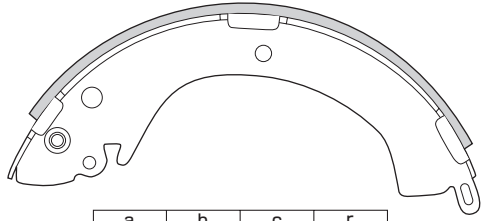
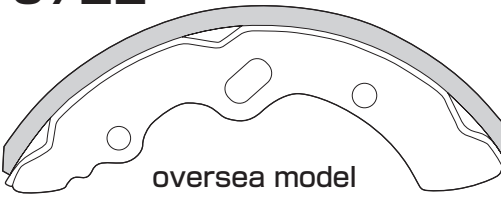
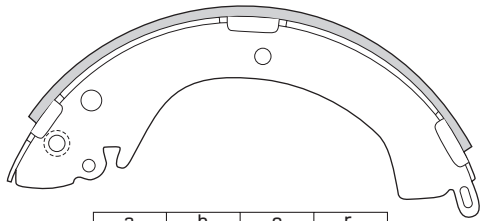
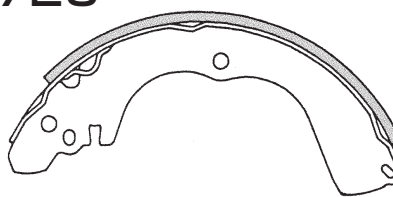
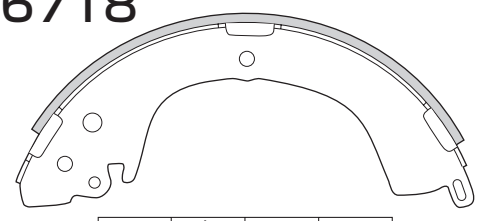
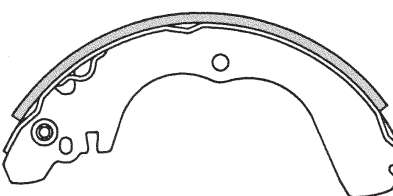
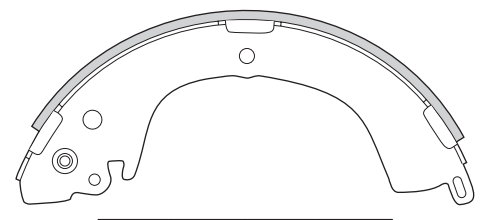
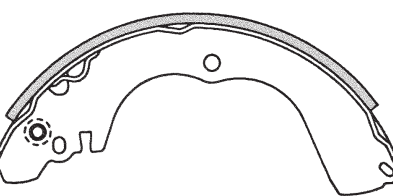
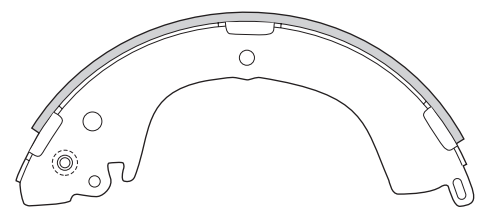
<p>FN-6715</p>  <p>LN6715 (Rear)</p> <table border="1" data-bbox="412 523 707 584"> <thead> <tr><th>a</th><th>b</th><th>c</th><th>r</th></tr> </thead> <tbody> <tr><td>4.5</td><td>2</td><td>50</td><td>127</td></tr> </tbody> </table> <p>2pcs.</p>	a	b	c	r	4.5	2	50	127	<p>FN-6721</p>  <p>LN6721 (Rear)</p> <table border="1" data-bbox="1084 523 1379 584"> <thead> <tr><th>a</th><th>b</th><th>c</th><th>r</th></tr> </thead> <tbody> <tr><td>4.5</td><td>2.0</td><td>52</td><td>135</td></tr> </tbody> </table> <p>4pcs.</p>	a	b	c	r	4.5	2.0	52	135
a	b	c	r														
4.5	2	50	127														
a	b	c	r														
4.5	2.0	52	135														
<p>FN-6716</p>  <p>LN6716</p> <table border="1" data-bbox="412 840 707 901"> <thead> <tr><th>a</th><th>b</th><th>c</th><th>r</th></tr> </thead> <tbody> <tr><td>4.5</td><td>2</td><td>50</td><td>127</td></tr> </tbody> </table> <p>1pc.</p>	a	b	c	r	4.5	2	50	127	<p>FN-6722</p> <p>oversea model</p>  <p>LN6722 (F&R)</p> <table border="1" data-bbox="1084 840 1379 901"> <thead> <tr><th>a</th><th>b</th><th>c</th><th>r</th></tr> </thead> <tbody> <tr><td>6.0</td><td>3.2</td><td>110</td><td>159.1</td></tr> </tbody> </table> <p>4pcs.</p>	a	b	c	r	6.0	3.2	110	159.1
a	b	c	r														
4.5	2	50	127														
a	b	c	r														
6.0	3.2	110	159.1														
<p>FN-6717</p>  <p>LN6717</p> <table border="1" data-bbox="412 1157 707 1218"> <thead> <tr><th>a</th><th>b</th><th>c</th><th>r</th></tr> </thead> <tbody> <tr><td>4.5</td><td>2</td><td>50</td><td>127</td></tr> </tbody> </table> <p>1pc.</p>	a	b	c	r	4.5	2	50	127	<p>FN-6723</p>  <p>LN6723 (Rear)</p> <table border="1" data-bbox="1084 1157 1379 1218"> <thead> <tr><th>a</th><th>b</th><th>c</th><th>r</th></tr> </thead> <tbody> <tr><td>3.2</td><td>2.3</td><td>30</td><td>114.3</td></tr> </tbody> </table> <p>2pcs.</p>	a	b	c	r	3.2	2.3	30	114.3
a	b	c	r														
4.5	2	50	127														
a	b	c	r														
3.2	2.3	30	114.3														
<p>FN-6718</p>  <p>LN6718 (Rear)</p> <table border="1" data-bbox="412 1473 707 1534"> <thead> <tr><th>a</th><th>b</th><th>c</th><th>r</th></tr> </thead> <tbody> <tr><td>4.5</td><td>2</td><td>52</td><td>135</td></tr> </tbody> </table> <p>2pcs.</p>	a	b	c	r	4.5	2	52	135	<p>FN-6724</p>  <p>LN6724</p> <table border="1" data-bbox="1084 1473 1379 1534"> <thead> <tr><th>a</th><th>b</th><th>c</th><th>r</th></tr> </thead> <tbody> <tr><td>3.2</td><td>2.3</td><td>30</td><td>114.3</td></tr> </tbody> </table> <p>1pc.</p>	a	b	c	r	3.2	2.3	30	114.3
a	b	c	r														
4.5	2	52	135														
a	b	c	r														
3.2	2.3	30	114.3														
<p>FN-6719</p>  <p>LN6719</p> <table border="1" data-bbox="412 1790 707 1851"> <thead> <tr><th>a</th><th>b</th><th>c</th><th>r</th></tr> </thead> <tbody> <tr><td>4.5</td><td>2.0</td><td>52</td><td>135</td></tr> </tbody> </table> <p>1pc.</p>	a	b	c	r	4.5	2.0	52	135	<p>FN-6725</p>  <p>LN6725</p> <table border="1" data-bbox="1084 1790 1379 1851"> <thead> <tr><th>a</th><th>b</th><th>c</th><th>r</th></tr> </thead> <tbody> <tr><td>3.2</td><td>2.3</td><td>30</td><td>114.3</td></tr> </tbody> </table> <p>1pc.</p>	a	b	c	r	3.2	2.3	30	114.3
a	b	c	r														
4.5	2.0	52	135														
a	b	c	r														
3.2	2.3	30	114.3														
<p>FN-6720</p>  <p>LN6720</p> <table border="1" data-bbox="412 2107 707 2168"> <thead> <tr><th>a</th><th>b</th><th>c</th><th>r</th></tr> </thead> <tbody> <tr><td>4.5</td><td>2.0</td><td>52</td><td>135</td></tr> </tbody> </table> <p>1pc.</p>	a	b	c	r	4.5	2.0	52	135									
a	b	c	r														
4.5	2.0	52	135														

FN-6726

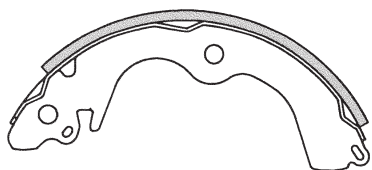

a	b	c	r
2.9	1.6	24	90

LN6726

(Rear)

2pcs.

FN-6733

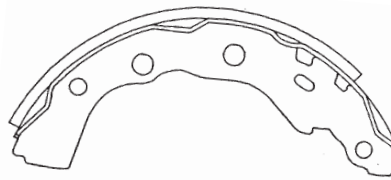

a	b	c	r
2.9	2	36	101.6

LN6733

2pcs.

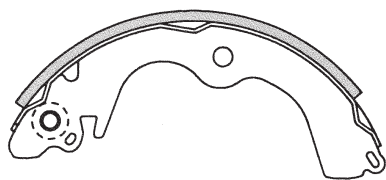

a	b	c	r
2.9	1.6	24	90

LN6727

1pc.

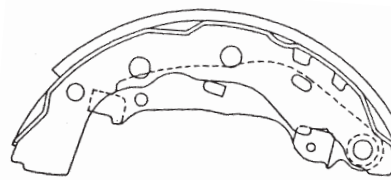

a	b	c	r
2.9	2	36	101.6

LN6734

1pc.

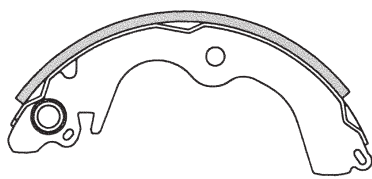

a	b	c	r
2.9	1.6	24	90

LN6728

1pc.

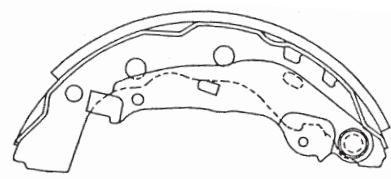

a	b	c	r
2.9	2	36	101.6

LN6735

1pc.

FN-6729

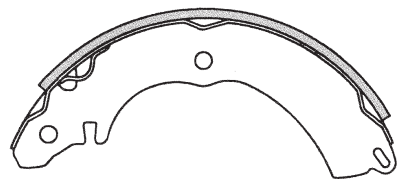

a	b	c	r
3.2	2	30	101.5

LN6729

(Rear)

2pcs.

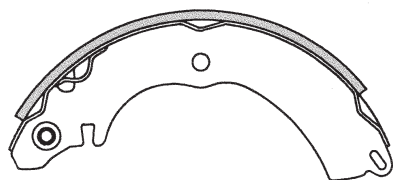

a	b	c	r
3.2	2	30	101.5

LN6730

1pc.

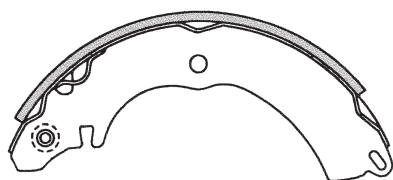

a	b	c	r
3.2	2	30	101.5

LN6731

1pc.

FN-6741

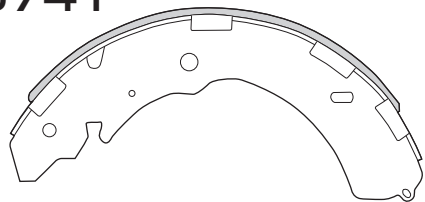

LN6741
(Rear)

a	b	c	r
3.6	2.3	49	147.5

2pcs.

FN-6901

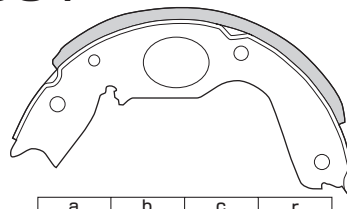

LN6901
(Parking)

a	b	c	r
6	1.6	38.1	98.5

2pcs.

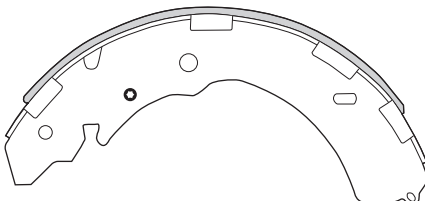

LN6742

a	b	c	r
3.6	2.3	49	147.5

1pc.

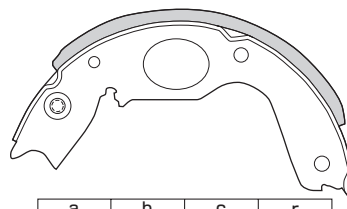

LN6902

a	b	c	r
6	1.6	38.1	98.5

1pc.

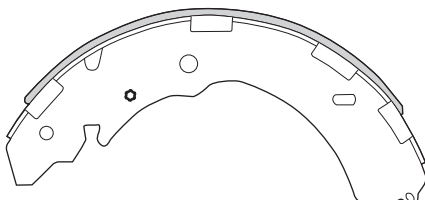

LN6743

a	b	c	r
3.6	2.3	49	147.5

1pc.

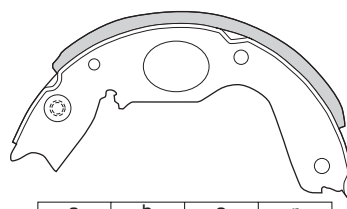

LN6903

a	b	c	r
6	1.6	38.1	98.5

1pc.

FN-6744

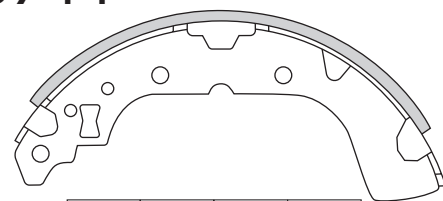

LN6744

a	b	c	r
2.9	2	25	90

4pcs.

FN-6904

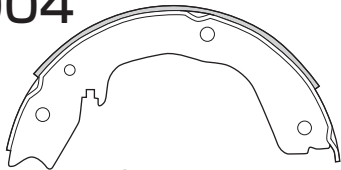

Superseded from FN-MN-150861

LN6904

a	b	c	r
6	2	34.2	99.6

2pcs.

(Parking)

Superseded from FN-MN-150861

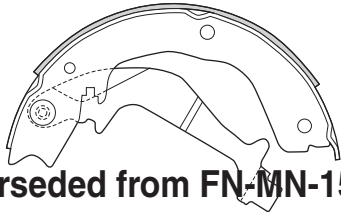

LN6905

a	b	c	r
6	2	34.2	99.6

1pc.

Superseded from FN-MN-150861

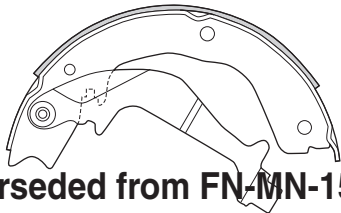

LN6906

a	b	c	r
6	2	34.2	99.6

1pc.

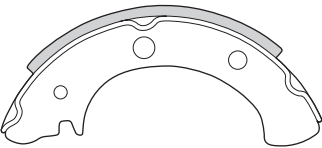
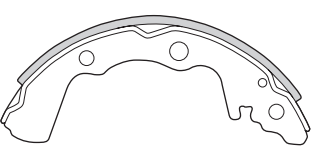
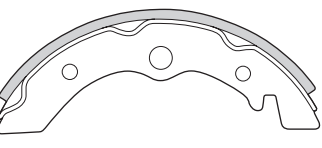
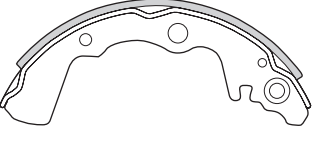
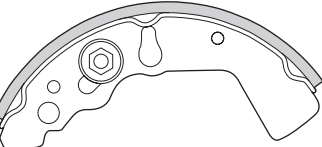
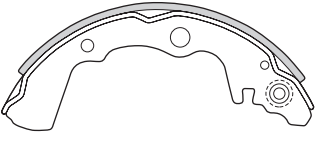
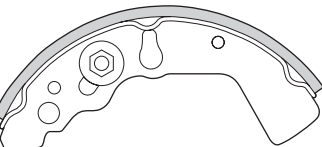
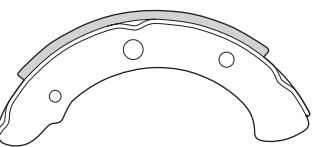
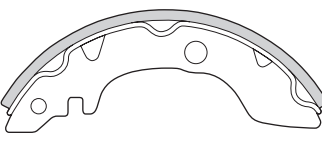
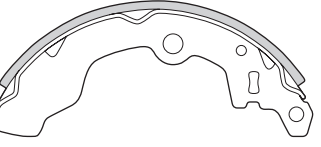
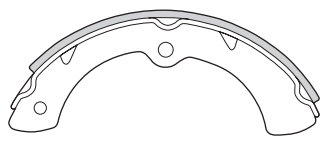
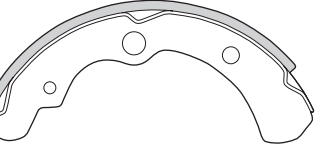
<p>FN-7711</p>  <p>LN7711 (Rear)</p> <table border="1" data-bbox="412 523 707 584"> <thead> <tr> <th>a</th> <th>b</th> <th>c</th> <th>r</th> </tr> </thead> <tbody> <tr> <td>3.2</td> <td>2.3</td> <td>30</td> <td>90</td> </tr> </tbody> </table> <p>4pcs.</p>	a	b	c	r	3.2	2.3	30	90	<p>FN-7724</p>  <p>LN7724 (Rear)</p> <table border="1" data-bbox="1093 523 1388 584"> <thead> <tr> <th>a</th> <th>b</th> <th>c</th> <th>r</th> </tr> </thead> <tbody> <tr> <td>3.2</td> <td>1.6</td> <td>30</td> <td>90</td> </tr> </tbody> </table> <p>2pcs.</p>	a	b	c	r	3.2	1.6	30	90
a	b	c	r														
3.2	2.3	30	90														
a	b	c	r														
3.2	1.6	30	90														
<p>FN-7713</p>  <p>LN7713 (Rear)</p> <table border="1" data-bbox="412 852 707 913"> <thead> <tr> <th>a</th> <th>b</th> <th>c</th> <th>r</th> </tr> </thead> <tbody> <tr> <td>2.6</td> <td>1.6</td> <td>29</td> <td>85</td> </tr> </tbody> </table> <p>4pcs.</p>	a	b	c	r	2.6	1.6	29	85	<p>FN-7725</p>  <p>LN7725</p> <table border="1" data-bbox="1093 852 1388 913"> <thead> <tr> <th>a</th> <th>b</th> <th>c</th> <th>r</th> </tr> </thead> <tbody> <tr> <td>3.2</td> <td>1.6</td> <td>30</td> <td>90</td> </tr> </tbody> </table> <p>1pc.</p>	a	b	c	r	3.2	1.6	30	90
a	b	c	r														
2.6	1.6	29	85														
a	b	c	r														
3.2	1.6	30	90														
<p>FN-7720</p>  <p>LN7720 (Front)</p> <table border="1" data-bbox="412 1169 707 1230"> <thead> <tr> <th>a</th> <th>b</th> <th>c</th> <th>r</th> </tr> </thead> <tbody> <tr> <td>3.2</td> <td>2</td> <td>34</td> <td>90</td> </tr> </tbody> </table> <p>2pcs.</p>	a	b	c	r	3.2	2	34	90	<p>FN-7726</p>  <p>LN7726</p> <table border="1" data-bbox="1093 1169 1388 1230"> <thead> <tr> <th>a</th> <th>b</th> <th>c</th> <th>r</th> </tr> </thead> <tbody> <tr> <td>3.2</td> <td>1.6</td> <td>30</td> <td>90</td> </tr> </tbody> </table> <p>1pc.</p>	a	b	c	r	3.2	1.6	30	90
a	b	c	r														
3.2	2	34	90														
a	b	c	r														
3.2	1.6	30	90														
<p>FN-7721</p>  <p>LN7721</p> <table border="1" data-bbox="412 1485 707 1546"> <thead> <tr> <th>a</th> <th>b</th> <th>c</th> <th>r</th> </tr> </thead> <tbody> <tr> <td>3.2</td> <td>2</td> <td>34</td> <td>90</td> </tr> </tbody> </table> <p>2pcs.</p>	a	b	c	r	3.2	2	34	90	<p>FN-7727</p>  <p>LN7727 (Rear)</p> <table border="1" data-bbox="1093 1485 1388 1546"> <thead> <tr> <th>a</th> <th>b</th> <th>c</th> <th>r</th> </tr> </thead> <tbody> <tr> <td>3.2</td> <td>2.3</td> <td>30</td> <td>90</td> </tr> </tbody> </table> <p>4pcs.</p>	a	b	c	r	3.2	2.3	30	90
a	b	c	r														
3.2	2	34	90														
a	b	c	r														
3.2	2.3	30	90														
<p>FN-7722</p>  <p>LN7722 (Rear)</p> <table border="1" data-bbox="412 1814 707 1875"> <thead> <tr> <th>a</th> <th>b</th> <th>c</th> <th>r</th> </tr> </thead> <tbody> <tr> <td>2.6</td> <td>1.6</td> <td>29</td> <td>85</td> </tr> </tbody> </table> <p>4pcs.</p>	a	b	c	r	2.6	1.6	29	85	<p>FN-7728</p>  <p>LN7728 (Rear)</p> <table border="1" data-bbox="1093 1814 1388 1875"> <thead> <tr> <th>a</th> <th>b</th> <th>c</th> <th>r</th> </tr> </thead> <tbody> <tr> <td>3.2</td> <td>1.6</td> <td>30</td> <td>90</td> </tr> </tbody> </table> <p>4pcs.</p>	a	b	c	r	3.2	1.6	30	90
a	b	c	r														
2.6	1.6	29	85														
a	b	c	r														
3.2	1.6	30	90														
<p>FN-7723</p>  <p>LN7723 (Front)</p> <table border="1" data-bbox="412 2131 707 2192"> <thead> <tr> <th>a</th> <th>b</th> <th>c</th> <th>r</th> </tr> </thead> <tbody> <tr> <td>4</td> <td>2</td> <td>39</td> <td>110</td> </tr> </tbody> </table> <p>4pcs.</p>	a	b	c	r	4	2	39	110	<p>FN-7729</p>  <p>LN7729 (Rear)</p> <table border="1" data-bbox="1093 2131 1388 2192"> <thead> <tr> <th>a</th> <th>b</th> <th>c</th> <th>r</th> </tr> </thead> <tbody> <tr> <td>3.2</td> <td>1.6</td> <td>30</td> <td>90</td> </tr> </tbody> </table> <p>4pcs.</p>	a	b	c	r	3.2	1.6	30	90
a	b	c	r														
4	2	39	110														
a	b	c	r														
3.2	1.6	30	90														

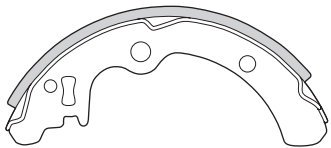
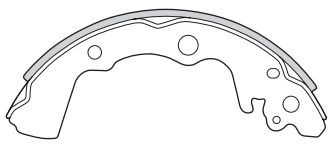
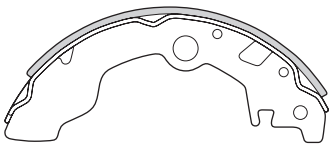
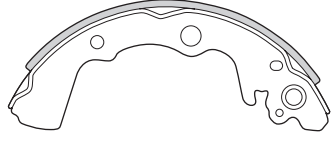
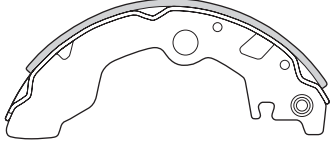
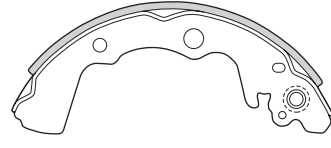
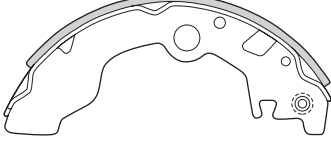
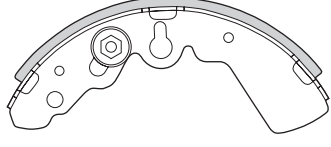
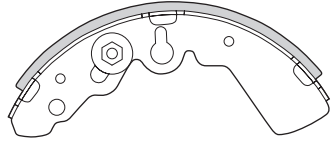
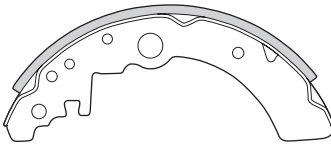
<p>FN-7730</p>  <table border="1" data-bbox="413 531 709 587"> <thead> <tr> <th>a</th> <th>b</th> <th>c</th> <th>r</th> </tr> </thead> <tbody> <tr> <td>3.2</td> <td>1.6</td> <td>30</td> <td>90</td> </tr> </tbody> </table> <p>LN7730(Rear) 4pcs.</p>	a	b	c	r	3.2	1.6	30	90	<p>FN-7734</p>  <table border="1" data-bbox="1089 531 1385 587"> <thead> <tr> <th>a</th> <th>b</th> <th>c</th> <th>r</th> </tr> </thead> <tbody> <tr> <td>3.2</td> <td>1.6</td> <td>30</td> <td>90</td> </tr> </tbody> </table> <p>LN7734 (Rear) 2pcs.</p>	a	b	c	r	3.2	1.6	30	90
a	b	c	r														
3.2	1.6	30	90														
a	b	c	r														
3.2	1.6	30	90														
<p>FN-7731</p>  <table border="1" data-bbox="413 852 709 908"> <thead> <tr> <th>a</th> <th>b</th> <th>c</th> <th>r</th> </tr> </thead> <tbody> <tr> <td>3.2</td> <td>1.6</td> <td>25</td> <td>90</td> </tr> </tbody> </table> <p>LN7731 (Rear) 2pcs.</p>	a	b	c	r	3.2	1.6	25	90	<p>FN-7735</p>  <table border="1" data-bbox="1089 852 1385 908"> <thead> <tr> <th>a</th> <th>b</th> <th>c</th> <th>r</th> </tr> </thead> <tbody> <tr> <td>3.2</td> <td>1.6</td> <td>30</td> <td>90</td> </tr> </tbody> </table> <p>LN7735 1pcs.</p>	a	b	c	r	3.2	1.6	30	90
a	b	c	r														
3.2	1.6	25	90														
a	b	c	r														
3.2	1.6	30	90														
<p>FN-7732</p>  <table border="1" data-bbox="413 1169 709 1225"> <thead> <tr> <th>a</th> <th>b</th> <th>c</th> <th>r</th> </tr> </thead> <tbody> <tr> <td>3.2</td> <td>1.6</td> <td>25</td> <td>90</td> </tr> </tbody> </table> <p>LN7732 1pc.</p>	a	b	c	r	3.2	1.6	25	90	<p>FN-7736</p>  <table border="1" data-bbox="1089 1169 1385 1225"> <thead> <tr> <th>a</th> <th>b</th> <th>c</th> <th>r</th> </tr> </thead> <tbody> <tr> <td>3.2</td> <td>1.6</td> <td>30</td> <td>90</td> </tr> </tbody> </table> <p>LN7736 1pc.</p>	a	b	c	r	3.2	1.6	30	90
a	b	c	r														
3.2	1.6	25	90														
a	b	c	r														
3.2	1.6	30	90														
<p>FN-7733</p>  <table border="1" data-bbox="413 1485 709 1541"> <thead> <tr> <th>a</th> <th>b</th> <th>c</th> <th>r</th> </tr> </thead> <tbody> <tr> <td>3.2</td> <td>1.6</td> <td>25</td> <td>90</td> </tr> </tbody> </table> <p>LN7733 1pc.</p>	a	b	c	r	3.2	1.6	25	90	<p>FN-7737</p>  <table border="1" data-bbox="1089 1485 1385 1541"> <thead> <tr> <th>a</th> <th>b</th> <th>c</th> <th>r</th> </tr> </thead> <tbody> <tr> <td>3.2</td> <td>2</td> <td>44</td> <td>95</td> </tr> </tbody> </table> <p>LN7737 (Front) 2pcs.</p>	a	b	c	r	3.2	2	44	95
a	b	c	r														
3.2	1.6	25	90														
a	b	c	r														
3.2	2	44	95														
<p>FN-7738</p>  <table border="1" data-bbox="1089 1812 1385 1868"> <thead> <tr> <th>a</th> <th>b</th> <th>c</th> <th>r</th> </tr> </thead> <tbody> <tr> <td>3.2</td> <td>2</td> <td>44</td> <td>95</td> </tr> </tbody> </table> <p>LN7738 2pcs.</p>	a	b	c	r	3.2	2	44	95	<p>FN-7743</p>  <table border="1" data-bbox="1089 2133 1385 2189"> <thead> <tr> <th>a</th> <th>b</th> <th>c</th> <th>r</th> </tr> </thead> <tbody> <tr> <td>3.2</td> <td>1.6</td> <td>30</td> <td>90</td> </tr> </tbody> </table> <p>LN7743(Rear) 4pcs.</p>	a	b	c	r	3.2	1.6	30	90
a	b	c	r														
3.2	2	44	95														
a	b	c	r														
3.2	1.6	30	90														

FN-7744

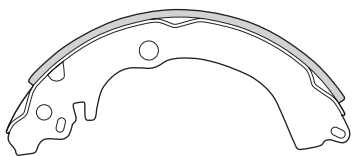

LN7744
(Rear)

a	b	c	r
3.2	1.6	35	101.6

2pcs.

FN-7750

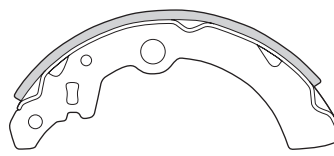

LN7750
(Rear)

a	b	c	r
3.2	1.6	30	90

2pcs.

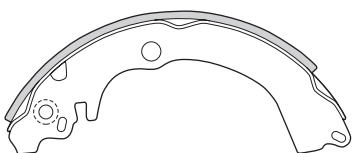

LN7745

a	b	c	r
3.2	1.6	35	101.6

1pc.

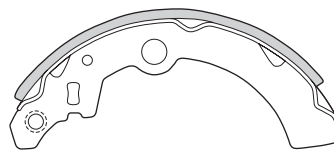

LN7751

a	b	c	r
3.2	1.6	30	90

1pc.

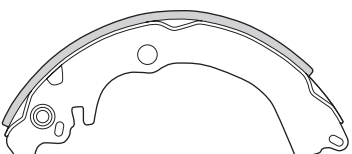

LN7746

a	b	c	r
3.2	1.6	35	101.6

1pc.

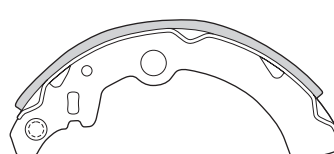

LN7752

a	b	c	r
3.2	1.6	30	90

1pc.

FN-7747

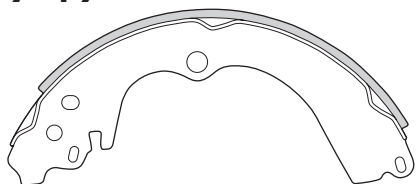

LN7747
(Rear)

a	b	c	r
3.2	1.6	35	114.3

2pcs.

FN-7753

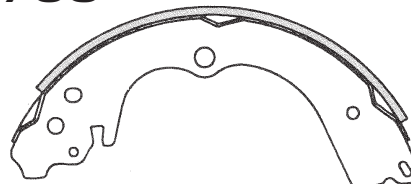

LN7753
(Rear)

a	b	c	r
3.2	1.6	35	114.3

2pcs.

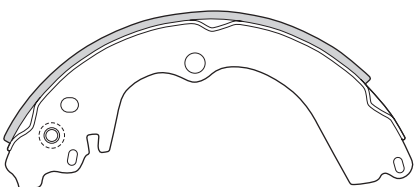

LN7748

a	b	c	r
3.2	1.6	35	114.3

1pc.

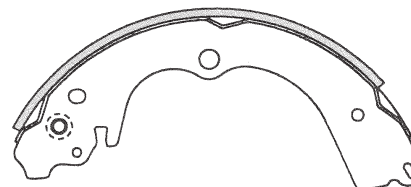

LN7754

a	b	c	r
3.2	1.6	35	114.3

1pc.

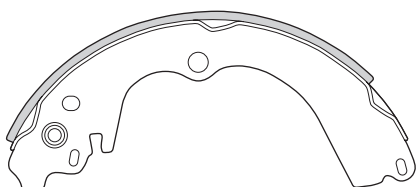

LN7749

a	b	c	r
3.2	1.6	35	114.3

1pc.

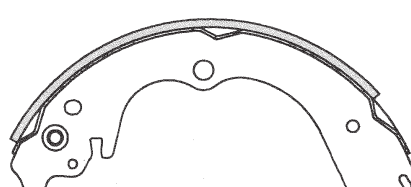

LN7755

a	b	c	r
3.2	1.6	35	114.3

1pc.

FN-7756

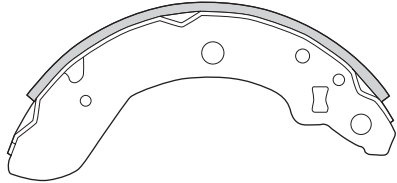

LN7756(Rear)

a	b	c	r
3	1.6	25	90

4pcs.

FN-7757

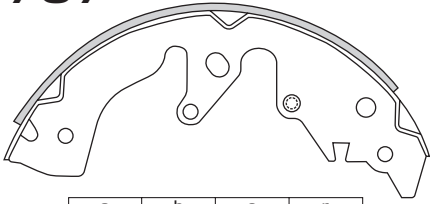

LN7757
(Rear)

a	b	c	r
3.6	2	40	127

1pc.

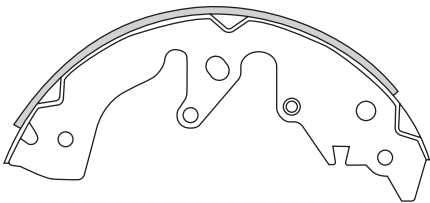

LN7758

a	b	c	r
3.6	2	40	127

1pc.

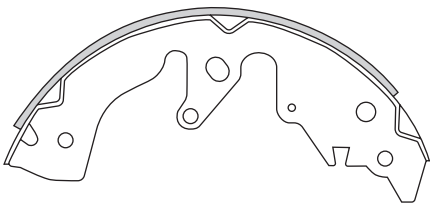

LN7759

a	b	c	r
3.6	2	40	127

2pcs.

New Products

FN-8802

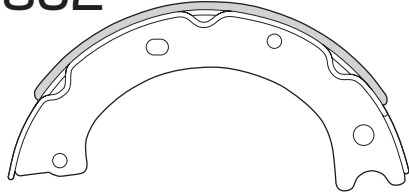

LN8802
(Parking)

a	b	c	r
4.5	2.3	45	101.6

2pcs.

FN-8804

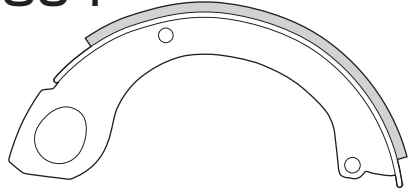

LN8804
(Parking)

a	b	c	r
4.5	2.6	45	101.6

2pcs.

FN-8805

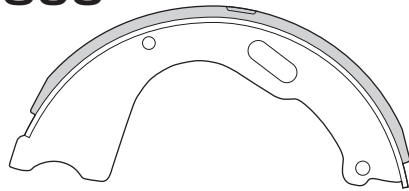

LN8805
(Parking)

a	b	c	r
6	2.6	75	127

2pcs.

FN-8806

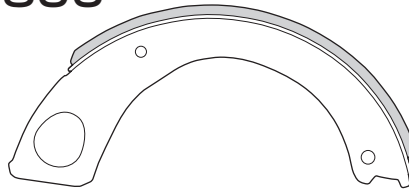

LN8806
(Parking)

a	b	c	r
6	2.6	75	152

2pcs.

New Products

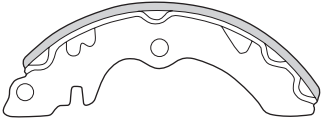
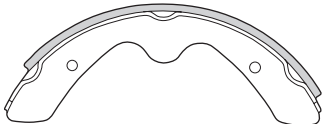
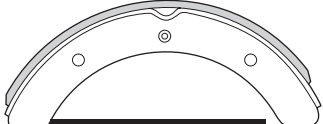
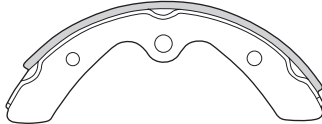
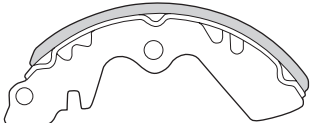
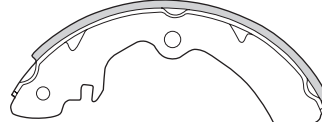
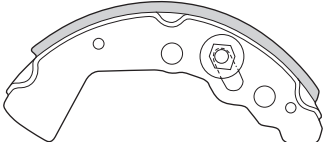
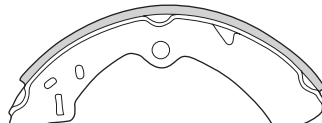
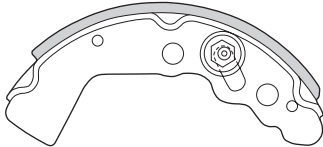
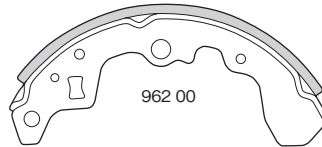
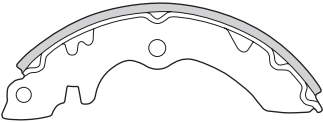
<p>FN-9902</p>  <p>LN9902 (Front & Rear & Parking)</p> <table border="1" data-bbox="413 538 713 587"> <thead> <tr> <th>a</th> <th>b</th> <th>c</th> <th>r</th> </tr> </thead> <tbody> <tr> <td>3.2</td> <td>1.6</td> <td>29</td> <td>90</td> </tr> </tbody> </table> <p>4pcs.</p>	a	b	c	r	3.2	1.6	29	90	<p>FN-9908</p>  <p>LN9908 (Front & Rear)</p> <table border="1" data-bbox="1085 538 1385 587"> <thead> <tr> <th>a</th> <th>b</th> <th>c</th> <th>r</th> </tr> </thead> <tbody> <tr> <td>4</td> <td>2</td> <td>34</td> <td>105</td> </tr> </tbody> </table> <p>4pcs.</p>	a	b	c	r	4	2	34	105
a	b	c	r														
3.2	1.6	29	90														
a	b	c	r														
4	2	34	105														
<p>FN-9903</p>  <p>DISCONTINUED</p> <p>LN9903 (Front & Rear)</p> <table border="1" data-bbox="419 855 718 903"> <thead> <tr> <th>a</th> <th>b</th> <th>c</th> <th>r</th> </tr> </thead> <tbody> <tr> <td>3.2</td> <td>2.3</td> <td>34</td> <td>105</td> </tr> </tbody> </table> <p>4pcs.</p>	a	b	c	r	3.2	2.3	34	105	<p>FN-9909</p>  <p>LN9909 (Front & Rear)</p> <table border="1" data-bbox="1085 855 1385 903"> <thead> <tr> <th>a</th> <th>b</th> <th>c</th> <th>r</th> </tr> </thead> <tbody> <tr> <td>4</td> <td>2</td> <td>34</td> <td>105</td> </tr> </tbody> </table> <p>4pcs.</p>	a	b	c	r	4	2	34	105
a	b	c	r														
3.2	2.3	34	105														
a	b	c	r														
4	2	34	105														
<p>FN-9904</p>  <p>LN9904 (Front & Rear)</p> <table border="1" data-bbox="413 1179 713 1227"> <thead> <tr> <th>a</th> <th>b</th> <th>c</th> <th>r</th> </tr> </thead> <tbody> <tr> <td>3.2</td> <td>2</td> <td>34</td> <td>90</td> </tr> </tbody> </table> <p>4pcs.</p>	a	b	c	r	3.2	2	34	90	<p>FN-9910</p>  <p>LN9910(Front)</p> <table border="1" data-bbox="1085 1179 1385 1227"> <thead> <tr> <th>a</th> <th>b</th> <th>c</th> <th>r</th> </tr> </thead> <tbody> <tr> <td>4</td> <td>2</td> <td>39</td> <td>110</td> </tr> </tbody> </table> <p>4pcs.</p>	a	b	c	r	4	2	39	110
a	b	c	r														
3.2	2	34	90														
a	b	c	r														
4	2	39	110														
<p>FN-9905</p>  <p>LN9905 (Front)</p> <table border="1" data-bbox="413 1493 713 1541"> <thead> <tr> <th>a</th> <th>b</th> <th>c</th> <th>r</th> </tr> </thead> <tbody> <tr> <td>3.2</td> <td>2</td> <td>34</td> <td>90</td> </tr> </tbody> </table> <p>2pcs.</p>	a	b	c	r	3.2	2	34	90	<p>FN-9913</p>  <p>LN9913(Rear)</p> <table border="1" data-bbox="1085 1493 1385 1541"> <thead> <tr> <th>a</th> <th>b</th> <th>c</th> <th>r</th> </tr> </thead> <tbody> <tr> <td>4</td> <td>2</td> <td>39</td> <td>110</td> </tr> </tbody> </table> <p>4pcs.</p>	a	b	c	r	4	2	39	110
a	b	c	r														
3.2	2	34	90														
a	b	c	r														
4	2	39	110														
<p>LN9906</p>  <table border="1" data-bbox="413 1817 713 1865"> <thead> <tr> <th>a</th> <th>b</th> <th>c</th> <th>r</th> </tr> </thead> <tbody> <tr> <td>3.2</td> <td>2</td> <td>34</td> <td>90</td> </tr> </tbody> </table> <p>2pcs.</p>	a	b	c	r	3.2	2	34	90	<p>FN-9914</p>  <p>962 00</p> <p>LN9914(Rear)</p> <table border="1" data-bbox="1085 1817 1385 1865"> <thead> <tr> <th>a</th> <th>b</th> <th>c</th> <th>r</th> </tr> </thead> <tbody> <tr> <td>2.9</td> <td>2</td> <td>30</td> <td>90</td> </tr> </tbody> </table> <p>4pcs.</p>	a	b	c	r	2.9	2	30	90
a	b	c	r														
3.2	2	34	90														
a	b	c	r														
2.9	2	30	90														
<p>FN-9907</p>  <p>LN9907(Rear)</p> <table border="1" data-bbox="413 2138 713 2187"> <thead> <tr> <th>a</th> <th>b</th> <th>c</th> <th>r</th> </tr> </thead> <tbody> <tr> <td>3.2</td> <td>2</td> <td>34</td> <td>90</td> </tr> </tbody> </table> <p>4pcs.</p>	a	b	c	r	3.2	2	34	90									
a	b	c	r														
3.2	2	34	90														

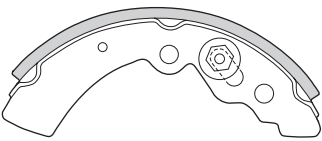
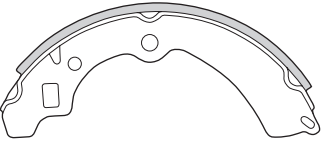
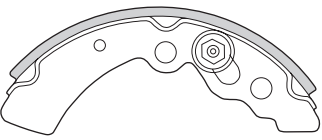
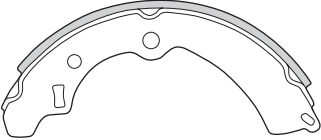
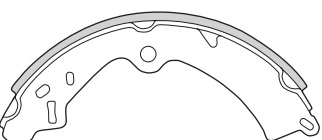
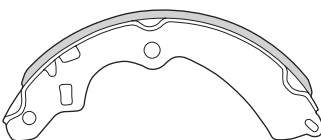
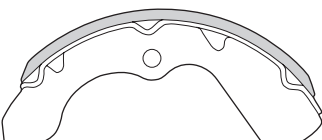
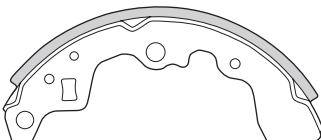
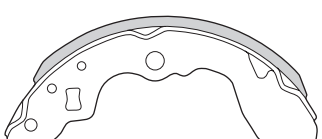
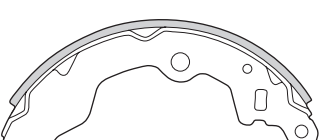
<p>FN-9915</p>  <p>LN9915 (Front)</p> <table border="1" data-bbox="421 531 716 584"> <thead> <tr> <th>a</th> <th>b</th> <th>c</th> <th>r</th> </tr> </thead> <tbody> <tr> <td>3.2</td> <td>2</td> <td>34</td> <td>90</td> </tr> </tbody> </table> <p>2pcs.</p>	a	b	c	r	3.2	2	34	90	<p>FN-9921</p>  <p>LN9921 (Rear)</p> <table border="1" data-bbox="1093 531 1388 584"> <thead> <tr> <th>a</th> <th>b</th> <th>c</th> <th>r</th> </tr> </thead> <tbody> <tr> <td>3.5</td> <td>2</td> <td>39</td> <td>110</td> </tr> </tbody> </table> <p>2pcs.</p>	a	b	c	r	3.5	2	39	110
a	b	c	r														
3.2	2	34	90														
a	b	c	r														
3.5	2	39	110														
<p>FN-9916</p>  <p>LN9916</p> <table border="1" data-bbox="421 852 716 906"> <thead> <tr> <th>a</th> <th>b</th> <th>c</th> <th>r</th> </tr> </thead> <tbody> <tr> <td>3.2</td> <td>2</td> <td>34</td> <td>90</td> </tr> </tbody> </table> <p>2pcs.</p>	a	b	c	r	3.2	2	34	90	<p>FN-9922</p>  <p>LN9922</p> <table border="1" data-bbox="1093 852 1388 906"> <thead> <tr> <th>a</th> <th>b</th> <th>c</th> <th>r</th> </tr> </thead> <tbody> <tr> <td>3.5</td> <td>2</td> <td>39</td> <td>110</td> </tr> </tbody> </table> <p>2pcs.</p>	a	b	c	r	3.5	2	39	110
a	b	c	r														
3.2	2	34	90														
a	b	c	r														
3.5	2	39	110														
<p>FN-9917</p>  <p>LN9917(Rear)</p> <table border="1" data-bbox="421 1169 716 1222"> <thead> <tr> <th>a</th> <th>b</th> <th>c</th> <th>r</th> </tr> </thead> <tbody> <tr> <td>4</td> <td>2</td> <td>39</td> <td>110</td> </tr> </tbody> </table> <p>4pcs.</p>	a	b	c	r	4	2	39	110	<p>FN-9923</p>  <p>LN9923(Rear)</p> <table border="1" data-bbox="1093 1169 1388 1222"> <thead> <tr> <th>a</th> <th>b</th> <th>c</th> <th>r</th> </tr> </thead> <tbody> <tr> <td>3.5</td> <td>2</td> <td>39</td> <td>110</td> </tr> </tbody> </table> <p>4pcs.</p>	a	b	c	r	3.5	2	39	110
a	b	c	r														
4	2	39	110														
a	b	c	r														
3.5	2	39	110														
<p>FN-9918</p>  <p>LN9918(Front)</p> <table border="1" data-bbox="421 1485 716 1539"> <thead> <tr> <th>a</th> <th>b</th> <th>c</th> <th>r</th> </tr> </thead> <tbody> <tr> <td>3.2</td> <td>2</td> <td>34</td> <td>90</td> </tr> </tbody> </table> <p>4pcs.</p>	a	b	c	r	3.2	2	34	90	<p>FN-9927</p>  <p>LN9927(Rear)</p> <table border="1" data-bbox="1093 1485 1388 1539"> <thead> <tr> <th>a</th> <th>b</th> <th>c</th> <th>r</th> </tr> </thead> <tbody> <tr> <td>2.9</td> <td>2</td> <td>30</td> <td>90</td> </tr> </tbody> </table> <p>4pcs.</p>	a	b	c	r	2.9	2	30	90
a	b	c	r														
3.2	2	34	90														
a	b	c	r														
2.9	2	30	90														
<p>FN-9919</p>  <p>LN9919(Rear)</p> <table border="1" data-bbox="421 1802 716 1856"> <thead> <tr> <th>a</th> <th>b</th> <th>c</th> <th>r</th> </tr> </thead> <tbody> <tr> <td>3.2</td> <td>2</td> <td>35</td> <td>90</td> </tr> </tbody> </table> <p>4pcs.</p>	a	b	c	r	3.2	2	35	90									
a	b	c	r														
3.2	2	35	90														
<p>FN-9920</p>  <p>LN9920(Rear)</p> <table border="1" data-bbox="421 2119 716 2172"> <thead> <tr> <th>a</th> <th>b</th> <th>c</th> <th>r</th> </tr> </thead> <tbody> <tr> <td>3.2</td> <td>1.6</td> <td>35</td> <td>90</td> </tr> </tbody> </table> <p>4pcs.</p>	a	b	c	r	3.2	1.6	35	90									
a	b	c	r														
3.2	1.6	35	90														

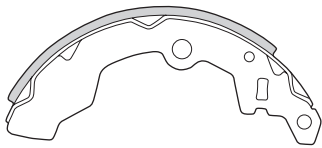
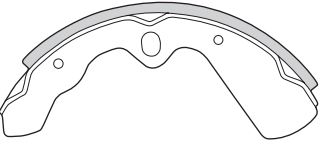
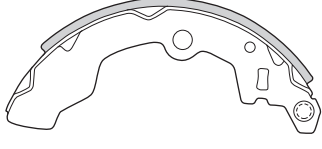
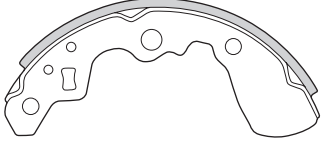
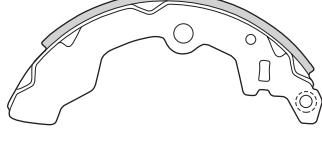
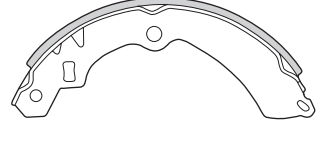
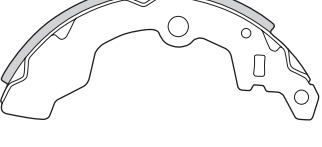
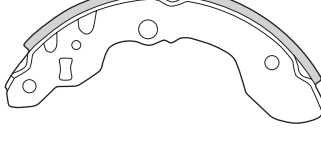
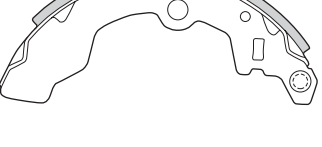
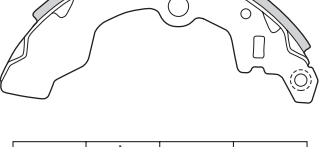

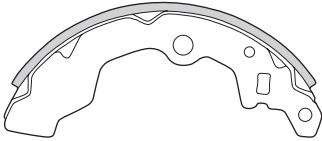
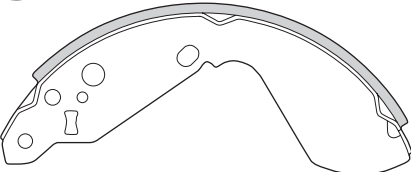
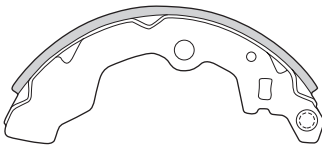
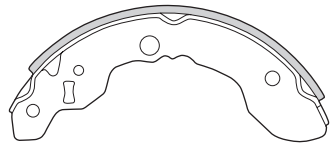
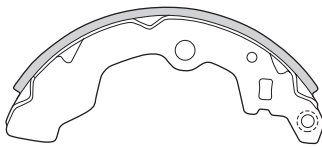
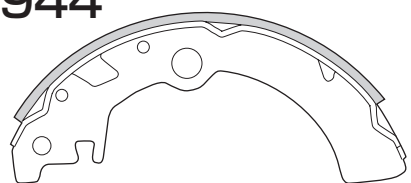
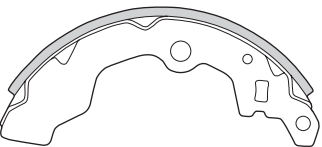
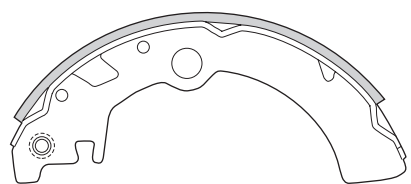
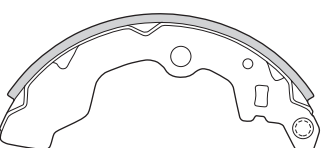
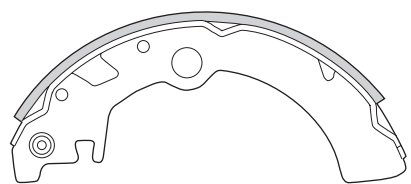
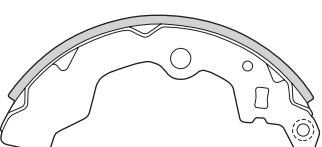
<p>FN-9928</p>  <p>LN9928 (Rear)</p> <table border="1" data-bbox="421 531 716 584"> <thead> <tr> <th>a</th> <th>b</th> <th>c</th> <th>r</th> </tr> </thead> <tbody> <tr> <td>3.2</td> <td>1.6</td> <td>35</td> <td>90</td> </tr> </tbody> </table> <p>2pcs.</p>	a	b	c	r	3.2	1.6	35	90	<p>FN-9932</p>  <p>LN9932(Front)</p> <table border="1" data-bbox="1093 531 1388 584"> <thead> <tr> <th>a</th> <th>b</th> <th>c</th> <th>r</th> </tr> </thead> <tbody> <tr> <td>3.2</td> <td>2</td> <td>35</td> <td>90</td> </tr> </tbody> </table> <p>4pcs.</p>	a	b	c	r	3.2	2	35	90
a	b	c	r														
3.2	1.6	35	90														
a	b	c	r														
3.2	2	35	90														
<p>FN-9929</p>  <p>LN9929</p> <table border="1" data-bbox="421 857 716 911"> <thead> <tr> <th>a</th> <th>b</th> <th>c</th> <th>r</th> </tr> </thead> <tbody> <tr> <td>3.2</td> <td>1.6</td> <td>35</td> <td>90</td> </tr> </tbody> </table> <p>1pc.</p>	a	b	c	r	3.2	1.6	35	90	<p>FN-9933</p>  <p>LN9933(Rear)</p> <table border="1" data-bbox="1093 857 1388 911"> <thead> <tr> <th>a</th> <th>b</th> <th>c</th> <th>r</th> </tr> </thead> <tbody> <tr> <td>2.9</td> <td>2</td> <td>25</td> <td>90</td> </tr> </tbody> </table> <p>4pcs.</p>	a	b	c	r	2.9	2	25	90
a	b	c	r														
3.2	1.6	35	90														
a	b	c	r														
2.9	2	25	90														
<p>FN-9930</p>  <p>LN9930</p> <table border="1" data-bbox="421 1183 716 1237"> <thead> <tr> <th>a</th> <th>b</th> <th>c</th> <th>r</th> </tr> </thead> <tbody> <tr> <td>3.2</td> <td>1.6</td> <td>35</td> <td>90</td> </tr> </tbody> </table> <p>1pc.</p>	a	b	c	r	3.2	1.6	35	90	<p>FN-9934</p>  <p>LN9934(Rear)</p> <table border="1" data-bbox="1093 1183 1388 1237"> <thead> <tr> <th>a</th> <th>b</th> <th>c</th> <th>r</th> </tr> </thead> <tbody> <tr> <td>3.5</td> <td>2</td> <td>34</td> <td>110</td> </tr> </tbody> </table> <p>4pcs.</p>	a	b	c	r	3.5	2	34	110
a	b	c	r														
3.2	1.6	35	90														
a	b	c	r														
3.5	2	34	110														
<p>FN-9931</p>  <p>LN9931 (Rear)</p> <table border="1" data-bbox="421 1510 716 1563"> <thead> <tr> <th>a</th> <th>b</th> <th>c</th> <th>r</th> </tr> </thead> <tbody> <tr> <td>3.2</td> <td>1.6</td> <td>30</td> <td>90</td> </tr> </tbody> </table> <p>2pcs.</p>	a	b	c	r	3.2	1.6	30	90	<p>FN-9937</p>  <p>LN9937(Rear)</p> <table border="1" data-bbox="1093 1510 1388 1563"> <thead> <tr> <th>a</th> <th>b</th> <th>c</th> <th>r</th> </tr> </thead> <tbody> <tr> <td>3.2</td> <td>2.6</td> <td>34</td> <td>110</td> </tr> </tbody> </table> <p>4pcs.</p>	a	b	c	r	3.2	2.6	34	110
a	b	c	r														
3.2	1.6	30	90														
a	b	c	r														
3.2	2.6	34	110														
<p>FN-9935</p>  <p>LN9935</p> <table border="1" data-bbox="421 1836 716 1890"> <thead> <tr> <th>a</th> <th>b</th> <th>c</th> <th>r</th> </tr> </thead> <tbody> <tr> <td>3.2</td> <td>1.6</td> <td>30</td> <td>90</td> </tr> </tbody> </table> <p>1pc.</p>	a	b	c	r	3.2	1.6	30	90									
a	b	c	r														
3.2	1.6	30	90														
<p>FN-9936</p>  <p>LN9936</p> <table border="1" data-bbox="421 2163 716 2216"> <thead> <tr> <th>a</th> <th>b</th> <th>c</th> <th>r</th> </tr> </thead> <tbody> <tr> <td>3.2</td> <td>1.6</td> <td>30</td> <td>90</td> </tr> </tbody> </table> <p>1pc.</p>	a	b	c	r	3.2	1.6	30	90									
a	b	c	r														
3.2	1.6	30	90														

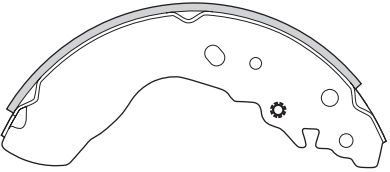
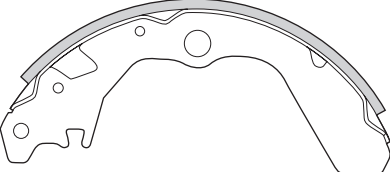
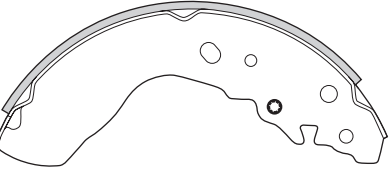
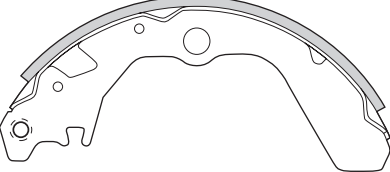
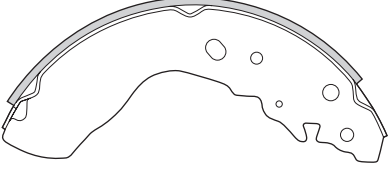
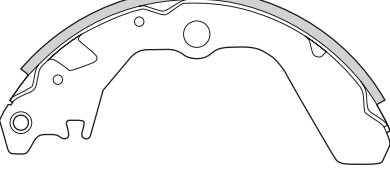
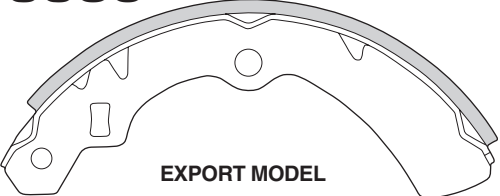
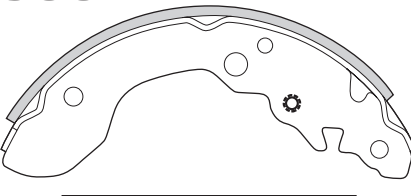
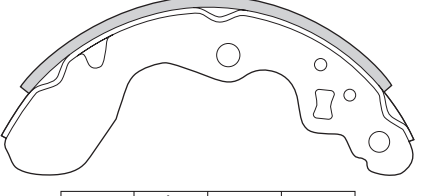
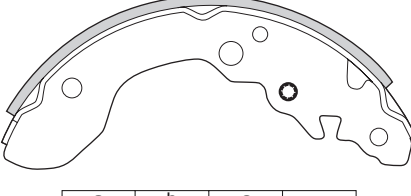
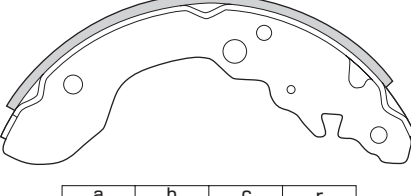
<p>FN-9938</p>  <p>LN7728 (Rear)</p> <table border="1" data-bbox="421 531 716 584"> <thead> <tr> <th>a</th> <th>b</th> <th>c</th> <th>r</th> </tr> </thead> <tbody> <tr> <td>3.2</td> <td>1.6</td> <td>30</td> <td>90</td> </tr> </tbody> </table> <p>2pcs.</p>	a	b	c	r	3.2	1.6	30	90	<p>FN-9942</p>  <p>LN9942(Rear)</p> <table border="1" data-bbox="1084 531 1379 584"> <thead> <tr> <th>a</th> <th>b</th> <th>c</th> <th>r</th> </tr> </thead> <tbody> <tr> <td>3.2</td> <td>2</td> <td>45</td> <td>127</td> </tr> </tbody> </table> <p>4pcs.</p>	a	b	c	r	3.2	2	45	127
a	b	c	r														
3.2	1.6	30	90														
a	b	c	r														
3.2	2	45	127														
<p>FN-9938</p>  <p>LN9938</p> <table border="1" data-bbox="421 847 716 901"> <thead> <tr> <th>a</th> <th>b</th> <th>c</th> <th>r</th> </tr> </thead> <tbody> <tr> <td>3.2</td> <td>1.6</td> <td>30</td> <td>90</td> </tr> </tbody> </table> <p>1pc.</p>	a	b	c	r	3.2	1.6	30	90	<p>FN-9943</p>  <p>LN9943(Rear)</p> <table border="1" data-bbox="1084 847 1379 901"> <thead> <tr> <th>a</th> <th>b</th> <th>c</th> <th>r</th> </tr> </thead> <tbody> <tr> <td>3.2</td> <td>2.6</td> <td>40</td> <td>110</td> </tr> </tbody> </table> <p>4pcs.</p>	a	b	c	r	3.2	2.6	40	110
a	b	c	r														
3.2	1.6	30	90														
a	b	c	r														
3.2	2.6	40	110														
<p>FN-9939</p>  <p>LN9939</p> <table border="1" data-bbox="421 1164 716 1218"> <thead> <tr> <th>a</th> <th>b</th> <th>c</th> <th>r</th> </tr> </thead> <tbody> <tr> <td>3.2</td> <td>1.6</td> <td>30</td> <td>90</td> </tr> </tbody> </table> <p>1pc.</p>	a	b	c	r	3.2	1.6	30	90	<p>FN-9944</p>  <p>LN9944 (Rear)</p> <table border="1" data-bbox="1084 1164 1379 1218"> <thead> <tr> <th>a</th> <th>b</th> <th>c</th> <th>r</th> </tr> </thead> <tbody> <tr> <td>3.2</td> <td>1.6</td> <td>25</td> <td>90.0</td> </tr> </tbody> </table> <p>2pcs.</p>	a	b	c	r	3.2	1.6	25	90.0
a	b	c	r														
3.2	1.6	30	90														
a	b	c	r														
3.2	1.6	25	90.0														
<p>FN-9940</p>  <p>LN9920 (Rear)</p> <table border="1" data-bbox="421 1485 716 1539"> <thead> <tr> <th>a</th> <th>b</th> <th>c</th> <th>r</th> </tr> </thead> <tbody> <tr> <td>3.2</td> <td>1.6</td> <td>35</td> <td>90</td> </tr> </tbody> </table> <p>2pcs.</p>	a	b	c	r	3.2	1.6	35	90	<p>FN-9945</p>  <p>LN9945</p> <table border="1" data-bbox="1084 1485 1379 1539"> <thead> <tr> <th>a</th> <th>b</th> <th>c</th> <th>r</th> </tr> </thead> <tbody> <tr> <td>3.2</td> <td>1.6</td> <td>25</td> <td>90.0</td> </tr> </tbody> </table> <p>1pc.</p>	a	b	c	r	3.2	1.6	25	90.0
a	b	c	r														
3.2	1.6	35	90														
a	b	c	r														
3.2	1.6	25	90.0														
<p>FN-9940</p>  <p>LN9940</p> <table border="1" data-bbox="421 1802 716 1856"> <thead> <tr> <th>a</th> <th>b</th> <th>c</th> <th>r</th> </tr> </thead> <tbody> <tr> <td>3.2</td> <td>1.6</td> <td>35</td> <td>90</td> </tr> </tbody> </table> <p>1pc.</p>	a	b	c	r	3.2	1.6	35	90	<p>FN-9946</p>  <p>LN9946</p> <table border="1" data-bbox="1084 1802 1379 1856"> <thead> <tr> <th>a</th> <th>b</th> <th>c</th> <th>r</th> </tr> </thead> <tbody> <tr> <td>3.2</td> <td>1.6</td> <td>25</td> <td>90.0</td> </tr> </tbody> </table> <p>1pc.</p>	a	b	c	r	3.2	1.6	25	90.0
a	b	c	r														
3.2	1.6	35	90														
a	b	c	r														
3.2	1.6	25	90.0														
<p>FN-9941</p>  <p>LN9941</p> <table border="1" data-bbox="421 2119 716 2172"> <thead> <tr> <th>a</th> <th>b</th> <th>c</th> <th>r</th> </tr> </thead> <tbody> <tr> <td>3.2</td> <td>1.6</td> <td>35</td> <td>90</td> </tr> </tbody> </table> <p>1pc.</p>	a	b	c	r	3.2	1.6	35	90									
a	b	c	r														
3.2	1.6	35	90														

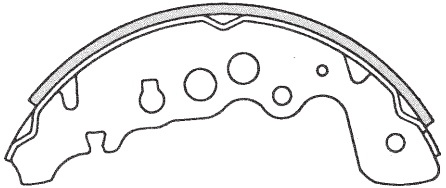
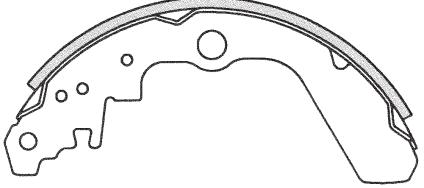
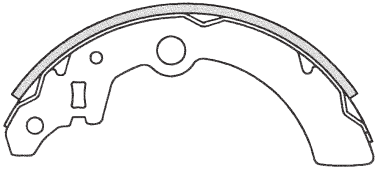
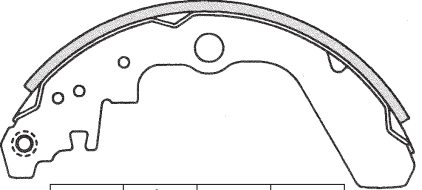
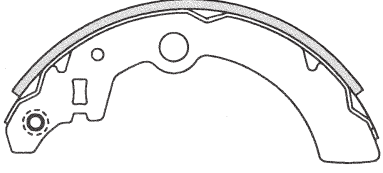
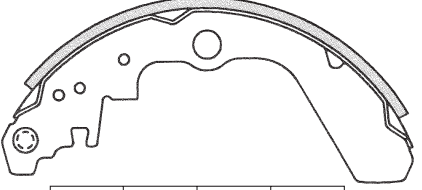
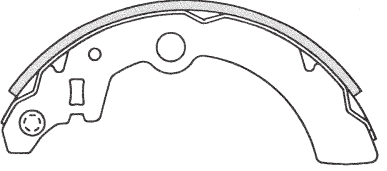
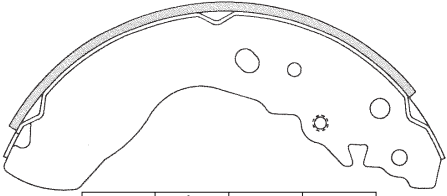
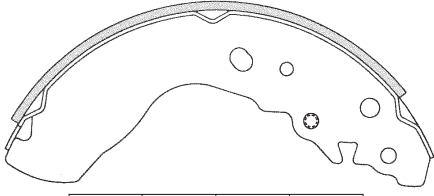
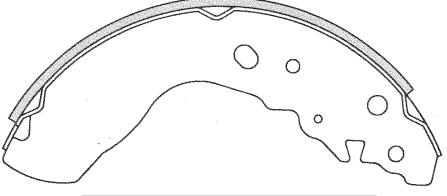
<p>FN-9947</p>  <p>LN9947 (Rear) 1 pc.</p> <table border="1" data-bbox="413 531 713 587"> <thead> <tr><th>a</th><th>b</th><th>c</th><th>r</th></tr> </thead> <tbody> <tr><td>3.2</td><td>2.0</td><td>45</td><td>127</td></tr> </tbody> </table>	a	b	c	r	3.2	2.0	45	127	<p>FN-9952</p>  <p>LN9952 (Rear) 2 pcs.</p> <table border="1" data-bbox="1085 531 1385 587"> <thead> <tr><th>a</th><th>b</th><th>c</th><th>r</th></tr> </thead> <tbody> <tr><td>3.2</td><td>1.6</td><td>30</td><td>100</td></tr> </tbody> </table>	a	b	c	r	3.2	1.6	30	100
a	b	c	r														
3.2	2.0	45	127														
a	b	c	r														
3.2	1.6	30	100														
 <p>LN9948 1 pc.</p> <table border="1" data-bbox="413 847 713 903"> <thead> <tr><th>a</th><th>b</th><th>c</th><th>r</th></tr> </thead> <tbody> <tr><td>3.2</td><td>2.0</td><td>45</td><td>127</td></tr> </tbody> </table>	a	b	c	r	3.2	2.0	45	127	 <p>LN9953 1 pc.</p> <table border="1" data-bbox="1085 847 1385 903"> <thead> <tr><th>a</th><th>b</th><th>c</th><th>r</th></tr> </thead> <tbody> <tr><td>3.2</td><td>1.6</td><td>30</td><td>100</td></tr> </tbody> </table>	a	b	c	r	3.2	1.6	30	100
a	b	c	r														
3.2	2.0	45	127														
a	b	c	r														
3.2	1.6	30	100														
 <p>LN9949 2 pcs.</p> <table border="1" data-bbox="413 1171 713 1227"> <thead> <tr><th>a</th><th>b</th><th>c</th><th>r</th></tr> </thead> <tbody> <tr><td>3.2</td><td>2.0</td><td>45</td><td>127</td></tr> </tbody> </table>	a	b	c	r	3.2	2.0	45	127	 <p>LN9954 1 pc.</p> <table border="1" data-bbox="1085 1171 1385 1227"> <thead> <tr><th>a</th><th>b</th><th>c</th><th>r</th></tr> </thead> <tbody> <tr><td>3.2</td><td>1.6</td><td>30</td><td>100</td></tr> </tbody> </table>	a	b	c	r	3.2	1.6	30	100
a	b	c	r														
3.2	2.0	45	127														
a	b	c	r														
3.2	1.6	30	100														
<p>FN-9950</p>  <p>LN9950 (Rear) 4 pcs.</p> <p>EXPORT MODEL</p> <table border="1" data-bbox="413 1495 713 1551"> <thead> <tr><th>a</th><th>b</th><th>c</th><th>r</th></tr> </thead> <tbody> <tr><td>3.5</td><td>2</td><td>39</td><td>110</td></tr> </tbody> </table>	a	b	c	r	3.5	2	39	110	<p>FN-9955</p>  <p>LN9955 (Rear) 1 pc.</p> <table border="1" data-bbox="1085 1495 1385 1551"> <thead> <tr><th>a</th><th>b</th><th>c</th><th>r</th></tr> </thead> <tbody> <tr><td>3.2</td><td>2.6</td><td>34</td><td>110</td></tr> </tbody> </table>	a	b	c	r	3.2	2.6	34	110
a	b	c	r														
3.5	2	39	110														
a	b	c	r														
3.2	2.6	34	110														
<p>FN-9951</p>  <p>LN9951 (Rear) 4 pcs.</p> <table border="1" data-bbox="413 1819 713 1875"> <thead> <tr><th>a</th><th>b</th><th>c</th><th>r</th></tr> </thead> <tbody> <tr><td>3.2</td><td>2.0</td><td>35</td><td>90</td></tr> </tbody> </table>	a	b	c	r	3.2	2.0	35	90	 <p>LN9956 1 pc.</p> <table border="1" data-bbox="1085 1819 1385 1875"> <thead> <tr><th>a</th><th>b</th><th>c</th><th>r</th></tr> </thead> <tbody> <tr><td>3.2</td><td>2.6</td><td>34</td><td>110</td></tr> </tbody> </table>	a	b	c	r	3.2	2.6	34	110
a	b	c	r														
3.2	2.0	35	90														
a	b	c	r														
3.2	2.6	34	110														
	 <p>LN9957 2 pcs.</p> <table border="1" data-bbox="1085 2143 1385 2199"> <thead> <tr><th>a</th><th>b</th><th>c</th><th>r</th></tr> </thead> <tbody> <tr><td>3.2</td><td>2.6</td><td>34</td><td>110</td></tr> </tbody> </table>	a	b	c	r	3.2	2.6	34	110								
a	b	c	r														
3.2	2.6	34	110														

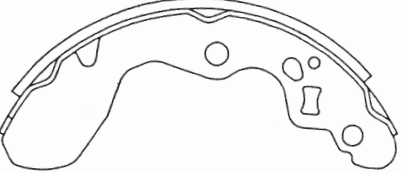
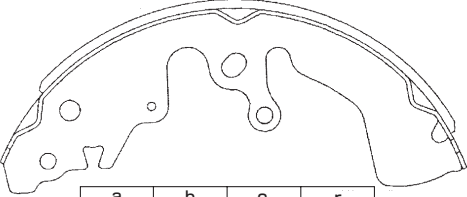
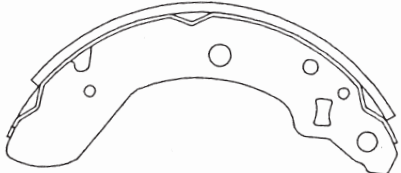
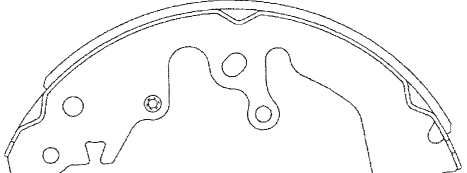
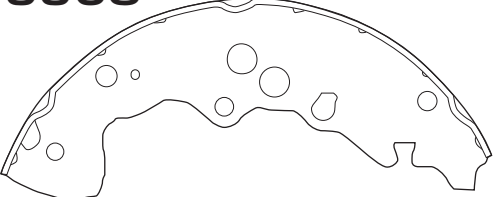
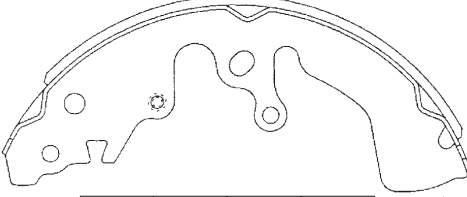
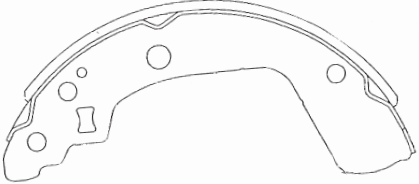
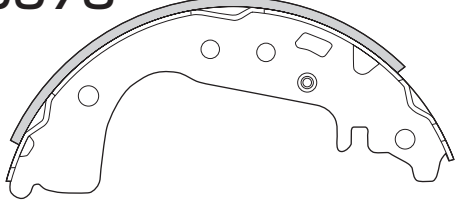
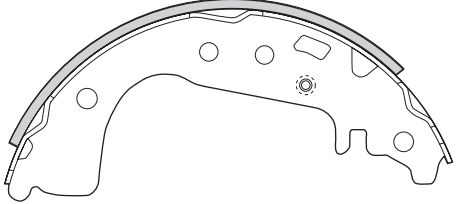
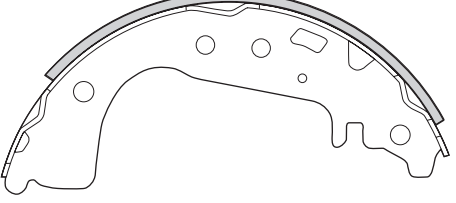

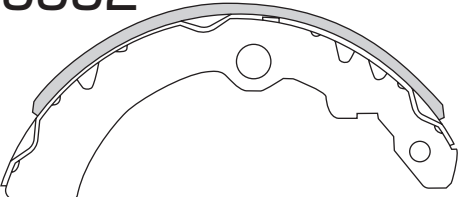
<p>FN-9958</p>  <p>LN9958(Rear)</p> <table border="1" data-bbox="415 531 713 589"> <thead> <tr> <th>a</th> <th>b</th> <th>c</th> <th>r</th> </tr> </thead> <tbody> <tr> <td>4</td> <td>2.6</td> <td>40</td> <td>110</td> </tr> </tbody> </table> <p>4pcs.</p>	a	b	c	r	4	2.6	40	110	<p>FN-9962</p>  <p>LN9962 (Rear)</p> <table border="1" data-bbox="1089 531 1387 589"> <thead> <tr> <th>a</th> <th>b</th> <th>c</th> <th>r</th> </tr> </thead> <tbody> <tr> <td>3.2</td> <td>1.6</td> <td>30</td> <td>100</td> </tr> </tbody> </table> <p>2pcs.</p>	a	b	c	r	3.2	1.6	30	100
a	b	c	r														
4	2.6	40	110														
a	b	c	r														
3.2	1.6	30	100														
<p>FN-9959</p>  <p>LN9959 (Rear)</p> <table border="1" data-bbox="415 847 713 906"> <thead> <tr> <th>a</th> <th>b</th> <th>c</th> <th>r</th> </tr> </thead> <tbody> <tr> <td>3.2</td> <td>1.6</td> <td>25</td> <td>90</td> </tr> </tbody> </table> <p>2pcs.</p>	a	b	c	r	3.2	1.6	25	90	 <p>LN9963</p> <table border="1" data-bbox="1089 847 1387 906"> <thead> <tr> <th>a</th> <th>b</th> <th>c</th> <th>r</th> </tr> </thead> <tbody> <tr> <td>3.2</td> <td>1.6</td> <td>30</td> <td>100</td> </tr> </tbody> </table> <p>1pc.</p>	a	b	c	r	3.2	1.6	30	100
a	b	c	r														
3.2	1.6	25	90														
a	b	c	r														
3.2	1.6	30	100														
 <p>LN9960</p> <table border="1" data-bbox="415 1169 713 1227"> <thead> <tr> <th>a</th> <th>b</th> <th>c</th> <th>r</th> </tr> </thead> <tbody> <tr> <td>3.2</td> <td>1.6</td> <td>25</td> <td>90</td> </tr> </tbody> </table> <p>1pc.</p>	a	b	c	r	3.2	1.6	25	90	 <p>LN9964</p> <table border="1" data-bbox="1089 1169 1387 1227"> <thead> <tr> <th>a</th> <th>b</th> <th>c</th> <th>r</th> </tr> </thead> <tbody> <tr> <td>3.2</td> <td>1.6</td> <td>30</td> <td>100</td> </tr> </tbody> </table> <p>1pc.</p>	a	b	c	r	3.2	1.6	30	100
a	b	c	r														
3.2	1.6	25	90														
a	b	c	r														
3.2	1.6	30	100														
 <p>LN9961</p> <table border="1" data-bbox="415 1485 713 1544"> <thead> <tr> <th>a</th> <th>b</th> <th>c</th> <th>r</th> </tr> </thead> <tbody> <tr> <td>3.2</td> <td>1.6</td> <td>25</td> <td>90</td> </tr> </tbody> </table> <p>1pc.</p>	a	b	c	r	3.2	1.6	25	90	<p>FN-9965 with spring & lever</p>  <p>LN9947 (Rear)</p> <table border="1" data-bbox="1089 1485 1387 1544"> <thead> <tr> <th>a</th> <th>b</th> <th>c</th> <th>r</th> </tr> </thead> <tbody> <tr> <td>3.2</td> <td>2</td> <td>45</td> <td>127</td> </tr> </tbody> </table> <p>1pc.</p>	a	b	c	r	3.2	2	45	127
a	b	c	r														
3.2	1.6	25	90														
a	b	c	r														
3.2	2	45	127														
	<p>with spring & lever</p>  <p>LN9948</p> <table border="1" data-bbox="1089 1802 1387 1861"> <thead> <tr> <th>a</th> <th>b</th> <th>c</th> <th>r</th> </tr> </thead> <tbody> <tr> <td>3.2</td> <td>2</td> <td>45</td> <td>127</td> </tr> </tbody> </table> <p>1pc.</p>	a	b	c	r	3.2	2	45	127								
a	b	c	r														
3.2	2	45	127														
	 <p>LN9949</p> <table border="1" data-bbox="1089 2119 1387 2177"> <thead> <tr> <th>a</th> <th>b</th> <th>c</th> <th>r</th> </tr> </thead> <tbody> <tr> <td>3.2</td> <td>2</td> <td>45</td> <td>127</td> </tr> </tbody> </table> <p>2pcs.</p>	a	b	c	r	3.2	2	45	127								
a	b	c	r														
3.2	2	45	127														

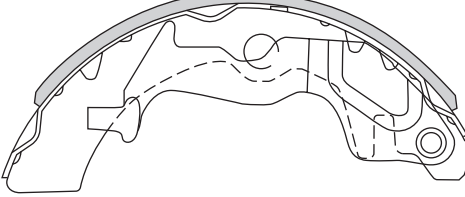
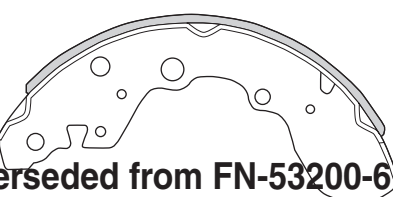
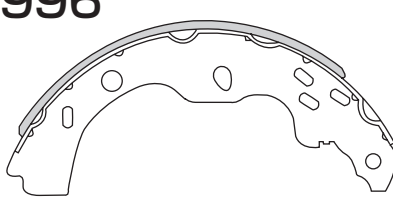
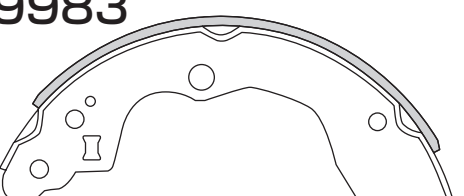
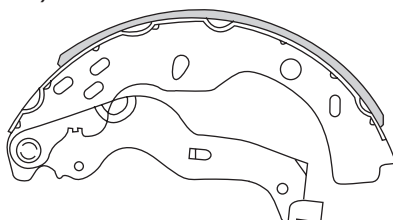
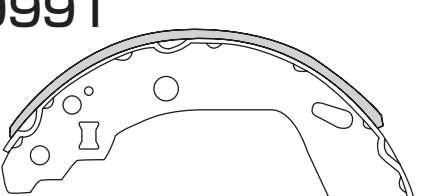
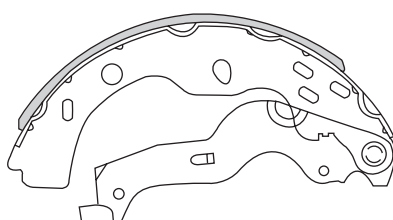

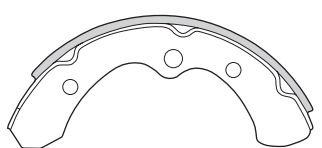
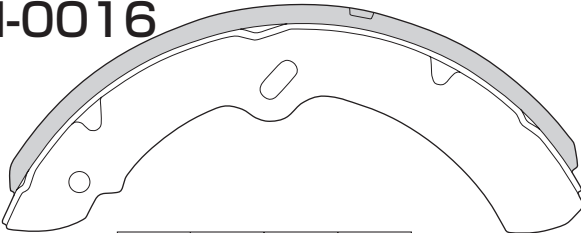
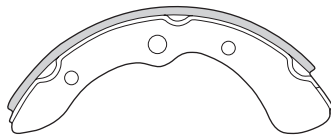
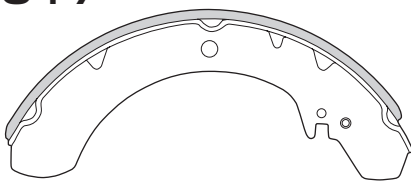
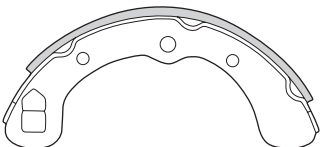
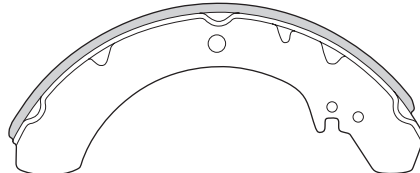
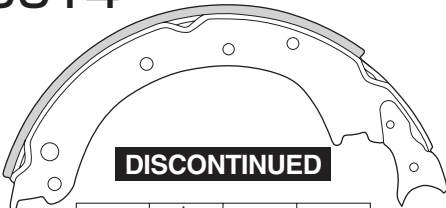
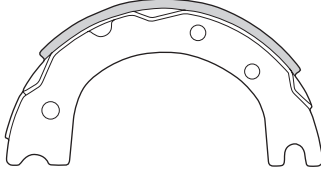
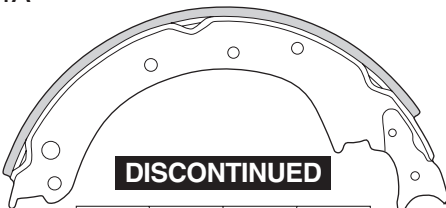
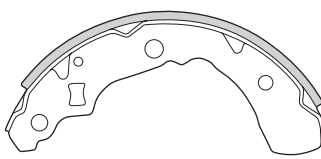
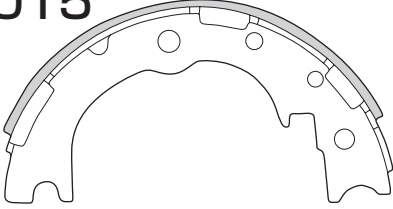
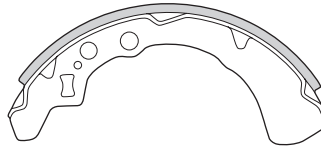

<p>FN-9966</p>  <p>LN9966(Rear)</p> <table border="1" data-bbox="415 538 713 587"> <thead> <tr> <th>a</th> <th>b</th> <th>c</th> <th>r</th> </tr> </thead> <tbody> <tr> <td>3.2</td> <td>2</td> <td>35</td> <td>90</td> </tr> </tbody> </table> <p>4pcs.</p>	a	b	c	r	3.2	2	35	90	<p>FN-9970</p>  <p>LN9970</p> <table border="1" data-bbox="1091 538 1388 587"> <thead> <tr> <th>a</th> <th>b</th> <th>c</th> <th>r</th> </tr> </thead> <tbody> <tr> <td>3.6</td> <td>2.0</td> <td>40</td> <td>127</td> </tr> </tbody> </table> <p>2pcs.</p>	a	b	c	r	3.6	2.0	40	127
a	b	c	r														
3.2	2	35	90														
a	b	c	r														
3.6	2.0	40	127														
<p>FN-9967</p>  <p>LN9967(Rear)</p> <table border="1" data-bbox="415 855 713 903"> <thead> <tr> <th>a</th> <th>b</th> <th>c</th> <th>r</th> </tr> </thead> <tbody> <tr> <td>2.9</td> <td>1.6</td> <td>25</td> <td>90</td> </tr> </tbody> </table> <p>4pcs.</p>	a	b	c	r	2.9	1.6	25	90	<p>FN-9971</p>  <p>LN9971</p> <table border="1" data-bbox="1091 855 1388 903"> <thead> <tr> <th>a</th> <th>b</th> <th>c</th> <th>r</th> </tr> </thead> <tbody> <tr> <td>3.6</td> <td>2.0</td> <td>40</td> <td>127</td> </tr> </tbody> </table> <p>1pc.</p>	a	b	c	r	3.6	2.0	40	127
a	b	c	r														
2.9	1.6	25	90														
a	b	c	r														
3.6	2.0	40	127														
<p>FN-9968</p>  <p>LN9968(Rear)</p> <table border="1" data-bbox="415 1176 713 1225"> <thead> <tr> <th>a</th> <th>b</th> <th>c</th> <th>r</th> </tr> </thead> <tbody> <tr> <td>4</td> <td>2.6</td> <td>55</td> <td>127</td> </tr> </tbody> </table> <p>4pc.</p>	a	b	c	r	4	2.6	55	127	<p>FN-9972</p>  <p>LN9972</p> <table border="1" data-bbox="1091 1176 1388 1225"> <thead> <tr> <th>a</th> <th>b</th> <th>c</th> <th>r</th> </tr> </thead> <tbody> <tr> <td>3.6</td> <td>2.0</td> <td>40</td> <td>127</td> </tr> </tbody> </table> <p>1pc.</p>	a	b	c	r	3.6	2.0	40	127
a	b	c	r														
4	2.6	55	127														
a	b	c	r														
3.6	2.0	40	127														
<p>FN-9969</p>  <p>LN9969</p> <table border="1" data-bbox="415 1498 713 1546"> <thead> <tr> <th>a</th> <th>b</th> <th>c</th> <th>r</th> </tr> </thead> <tbody> <tr> <td>2.9</td> <td>1.6</td> <td>30</td> <td>100</td> </tr> </tbody> </table> <p>4pc.</p>	a	b	c	r	2.9	1.6	30	100	<p>FN-9973</p>  <p>LN9973 (Rear)</p> <table border="1" data-bbox="1091 1498 1388 1546"> <thead> <tr> <th>a</th> <th>b</th> <th>c</th> <th>r</th> </tr> </thead> <tbody> <tr> <td>2.9</td> <td>2</td> <td>30</td> <td>100</td> </tr> </tbody> </table> <p>1pc.</p>	a	b	c	r	2.9	2	30	100
a	b	c	r														
2.9	1.6	30	100														
a	b	c	r														
2.9	2	30	100														
	<p>FN-9974</p>  <p>LN9974</p> <table border="1" data-bbox="1091 1809 1388 1858"> <thead> <tr> <th>a</th> <th>b</th> <th>c</th> <th>r</th> </tr> </thead> <tbody> <tr> <td>2.9</td> <td>2</td> <td>30</td> <td>100</td> </tr> </tbody> </table> <p>1pc.</p>	a	b	c	r	2.9	2	30	100								
a	b	c	r														
2.9	2	30	100														
	<p>FN-9975</p>  <p>LN9975</p> <table border="1" data-bbox="1091 2136 1388 2185"> <thead> <tr> <th>a</th> <th>b</th> <th>c</th> <th>r</th> </tr> </thead> <tbody> <tr> <td>2.9</td> <td>2</td> <td>30</td> <td>100</td> </tr> </tbody> </table> <p>2pcs.</p>	a	b	c	r	2.9	2	30	100								
a	b	c	r														
2.9	2	30	100														

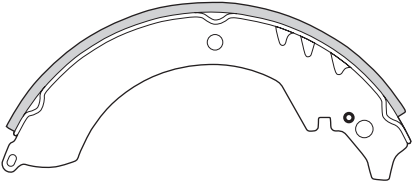
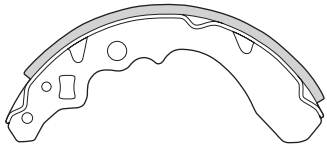
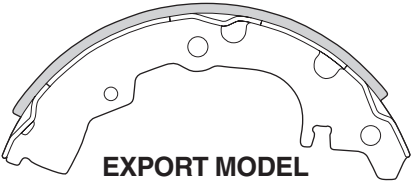
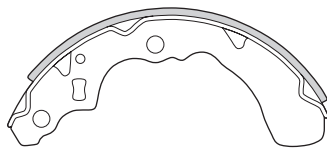
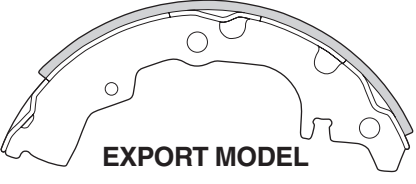
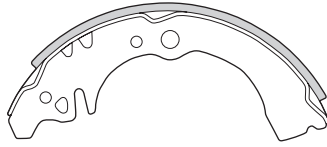
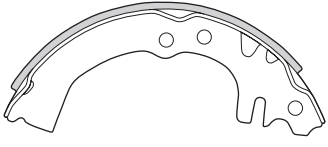
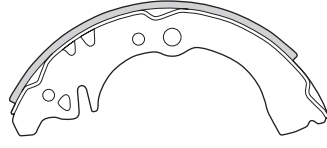
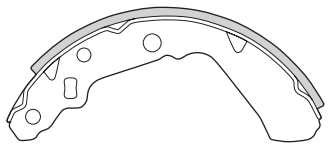
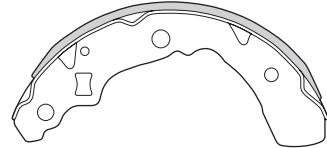
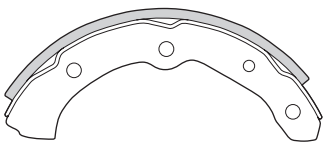
<p>FN-9980</p>  <p>Superseded from FN-53200-61J10</p> <table border="1" data-bbox="421 523 716 584"> <tr><th>a</th><th>b</th><th>c</th><th>r</th></tr> <tr><td>3.2</td><td>2</td><td>40</td><td>110</td></tr> </table> <p>LN9980 (Rear) 2pcs.</p>	a	b	c	r	3.2	2	40	110	<p>FN-9992</p>  <table border="1" data-bbox="1084 523 1388 584"> <tr><th>a</th><th>b</th><th>c</th><th>r</th></tr> <tr><td>3.2</td><td>1.6</td><td>25</td><td>90</td></tr> </table> <p>LN9992 (Rear) 2pcs.</p>	a	b	c	r	3.2	1.6	25	90
a	b	c	r														
3.2	2	40	110														
a	b	c	r														
3.2	1.6	25	90														
 <p>Superseded from FN-53200-61J10</p> <table border="1" data-bbox="421 840 716 901"> <tr><th>a</th><th>b</th><th>c</th><th>r</th></tr> <tr><td>3.2</td><td>2</td><td>40</td><td>110</td></tr> </table> <p>LN9981 1pc.</p>	a	b	c	r	3.2	2	40	110	 <table border="1" data-bbox="1084 840 1388 901"> <tr><th>a</th><th>b</th><th>c</th><th>r</th></tr> <tr><td>3.2</td><td>1.6</td><td>25</td><td>90</td></tr> </table> <p>LN9994 2pcs.</p>	a	b	c	r	3.2	1.6	25	90
a	b	c	r														
3.2	2	40	110														
a	b	c	r														
3.2	1.6	25	90														
 <p>Superseded from FN-53200-61J10</p> <table border="1" data-bbox="421 1157 716 1218"> <tr><th>a</th><th>b</th><th>c</th><th>r</th></tr> <tr><td>3.2</td><td>2</td><td>40</td><td>110</td></tr> </table> <p>LN9982 1pc.</p>	a	b	c	r	3.2	2	40	110	<p>FN-9996</p>  <table border="1" data-bbox="1084 1157 1388 1218"> <tr><th>a</th><th>b</th><th>c</th><th>r</th></tr> <tr><td>4</td><td>2</td><td>35</td><td>110</td></tr> </table> <p>LN9996 (Rear) 2pcs.</p>	a	b	c	r	4	2	35	110
a	b	c	r														
3.2	2	40	110														
a	b	c	r														
4	2	35	110														
<p>FN-9983</p>  <table border="1" data-bbox="412 1473 707 1534"> <tr><th>a</th><th>b</th><th>c</th><th>r</th></tr> <tr><td>3.2</td><td>2.3</td><td>35</td><td>110</td></tr> </table> <p>LN9983 4pcs.</p>	a	b	c	r	3.2	2.3	35	110	 <table border="1" data-bbox="1084 1473 1388 1534"> <tr><th>a</th><th>b</th><th>c</th><th>r</th></tr> <tr><td>4</td><td>2</td><td>35</td><td>110</td></tr> </table> <p>LN9997 1pcs.</p>	a	b	c	r	4	2	35	110
a	b	c	r														
3.2	2.3	35	110														
a	b	c	r														
4	2	35	110														
<p>FN-9991</p>  <table border="1" data-bbox="412 1790 707 1851"> <tr><th>a</th><th>b</th><th>c</th><th>r</th></tr> <tr><td>2.9</td><td>1.6</td><td>25</td><td>100</td></tr> </table> <p>LN9991 4pcs.</p>	a	b	c	r	2.9	1.6	25	100	 <table border="1" data-bbox="1084 1790 1388 1851"> <tr><th>a</th><th>b</th><th>c</th><th>r</th></tr> <tr><td>4</td><td>2</td><td>35</td><td>110</td></tr> </table> <p>LN9998 1pcs.</p>	a	b	c	r	4	2	35	110
a	b	c	r														
2.9	1.6	25	100														
a	b	c	r														
4	2	35	110														

New Products

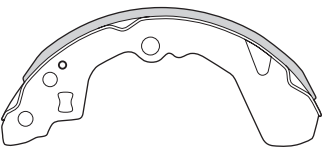
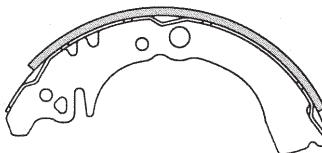
<h3>FN-0008</h3>  <p>LN0008 (Front)</p> <table border="1" data-bbox="412 523 707 584"> <tr><th>a</th><th>b</th><th>c</th><th>r</th></tr> <tr><td>3.2</td><td>2</td><td>35</td><td>90</td></tr> </table> <p>4pcs.</p>	a	b	c	r	3.2	2	35	90	<h3>FN-0016</h3>  <p>LN0016 (Front & Rear)</p> <table border="1" data-bbox="1084 523 1379 584"> <tr><th>a</th><th>b</th><th>c</th><th>r</th></tr> <tr><td>6</td><td>3.2</td><td>75</td><td>160</td></tr> </table> <p>4pcs.</p>	a	b	c	r	6	3.2	75	160
a	b	c	r														
3.2	2	35	90														
a	b	c	r														
6	3.2	75	160														
<h3>FN-0009</h3>  <p>LN0009 (Rear)</p> <table border="1" data-bbox="412 840 707 901"> <tr><th>a</th><th>b</th><th>c</th><th>r</th></tr> <tr><td>3.2</td><td>1.6</td><td>35</td><td>90</td></tr> </table> <p>2pcs.</p>	a	b	c	r	3.2	1.6	35	90	<h3>FN-0017</h3>  <p>LN0017 (Front & Rear)</p> <table border="1" data-bbox="1084 840 1379 901"> <tr><th>a</th><th>b</th><th>c</th><th>r</th></tr> <tr><td>4.5</td><td>2.3</td><td>44</td><td>127</td></tr> </table> <p>4pcs.</p>	a	b	c	r	4.5	2.3	44	127
a	b	c	r														
3.2	1.6	35	90														
a	b	c	r														
4.5	2.3	44	127														
<p>LN0010</p>  <table border="1" data-bbox="412 1157 707 1218"> <tr><th>a</th><th>b</th><th>c</th><th>r</th></tr> <tr><td>3.2</td><td>1.6</td><td>35</td><td>90</td></tr> </table> <p>2pcs.</p>	a	b	c	r	3.2	1.6	35	90	<h3>FN-0018</h3>  <p>LN0018 (Front)</p> <table border="1" data-bbox="1084 1157 1379 1218"> <tr><th>a</th><th>b</th><th>c</th><th>r</th></tr> <tr><td>4.5</td><td>2.3</td><td>44</td><td>127</td></tr> </table> <p>4pcs.</p>	a	b	c	r	4.5	2.3	44	127
a	b	c	r														
3.2	1.6	35	90														
a	b	c	r														
4.5	2.3	44	127														
<h3>FN-0014</h3>  <p>LN0014 (Front&Rear)</p> <table border="1" data-bbox="412 1485 707 1546"> <tr><th>a</th><th>b</th><th>c</th><th>r</th></tr> <tr><td>6</td><td>3.2</td><td>75</td><td>155</td></tr> </table> <p>2pcs.</p>	a	b	c	r	6	3.2	75	155	<h3>FN-0019</h3>  <p>LN0019 (Parking)</p> <table border="1" data-bbox="1084 1485 1379 1546"> <tr><th>a</th><th>b</th><th>c</th><th>r</th></tr> <tr><td>4.5</td><td>2</td><td>35</td><td>80</td></tr> </table> <p>2pcs.</p>	a	b	c	r	4.5	2	35	80
a	b	c	r														
6	3.2	75	155														
a	b	c	r														
4.5	2	35	80														
<p>LN0014A</p>  <table border="1" data-bbox="412 1802 707 1863"> <tr><th>a</th><th>b</th><th>c</th><th>r</th></tr> <tr><td>6</td><td>3.2</td><td>75</td><td>155</td></tr> </table> <p>2pcs.</p>	a	b	c	r	6	3.2	75	155	<h3>FN-0020</h3>  <p>LN0020 (Rear)</p> <table border="1" data-bbox="1084 1802 1379 1863"> <tr><th>a</th><th>b</th><th>c</th><th>r</th></tr> <tr><td>2.9</td><td>1.6</td><td>30</td><td>90</td></tr> </table> <p>4pcs.</p>	a	b	c	r	2.9	1.6	30	90
a	b	c	r														
6	3.2	75	155														
a	b	c	r														
2.9	1.6	30	90														
<h3>FN-0015</h3>  <p>LN0015 (Parking)</p> <table border="1" data-bbox="412 2131 707 2192"> <tr><th>a</th><th>b</th><th>c</th><th>r</th></tr> <tr><td>4.5</td><td>2</td><td>35</td><td>89</td></tr> </table> <p>2pcs.</p>	a	b	c	r	4.5	2	35	89	<h3>FN-0021</h3>  <p>LN0021 (Rear)</p> <table border="1" data-bbox="1084 2131 1379 2192"> <tr><th>a</th><th>b</th><th>c</th><th>r</th></tr> <tr><td>3.2</td><td>1.6</td><td>35</td><td>90</td></tr> </table> <p>4pcs.</p>	a	b	c	r	3.2	1.6	35	90
a	b	c	r														
4.5	2	35	89														
a	b	c	r														
3.2	1.6	35	90														

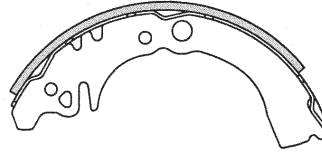
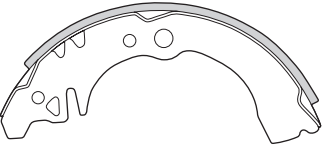
<p>FN-0022</p>  <p>LN0022 (Rear)</p> <table border="1" data-bbox="413 533 713 587"> <thead> <tr> <th>a</th> <th>b</th> <th>c</th> <th>r</th> </tr> </thead> <tbody> <tr> <td>4.5</td> <td>2.3</td> <td>44</td> <td>127</td> </tr> </tbody> </table> <p>4pcs.</p>	a	b	c	r	4.5	2.3	44	127	<p>FN-0027</p>  <p>LN0027 (Rear)</p> <table border="1" data-bbox="1089 533 1388 587"> <thead> <tr> <th>a</th> <th>b</th> <th>c</th> <th>r</th> </tr> </thead> <tbody> <tr> <td>3.2</td> <td>1.6</td> <td>24.5</td> <td>82.5</td> </tr> </tbody> </table> <p>4pcs.</p>	a	b	c	r	3.2	1.6	24.5	82.5
a	b	c	r														
4.5	2.3	44	127														
a	b	c	r														
3.2	1.6	24.5	82.5														
<p>FN-0023</p>  <p>EXPORT MODEL</p> <p>LN0023 (Rear)</p> <table border="1" data-bbox="431 850 731 903"> <thead> <tr> <th>a</th> <th>b</th> <th>c</th> <th>r</th> </tr> </thead> <tbody> <tr> <td>3.2</td> <td>1.6</td> <td>30</td> <td>90</td> </tr> </tbody> </table> <p>2pcs.</p>	a	b	c	r	3.2	1.6	30	90	<p>FN-0028</p>  <p>LN0028 (Rear)</p> <table border="1" data-bbox="1089 850 1388 903"> <thead> <tr> <th>a</th> <th>b</th> <th>c</th> <th>r</th> </tr> </thead> <tbody> <tr> <td>3.2</td> <td>1.6</td> <td>35</td> <td>90</td> </tr> </tbody> </table> <p>4pcs.</p>	a	b	c	r	3.2	1.6	35	90
a	b	c	r														
3.2	1.6	30	90														
a	b	c	r														
3.2	1.6	35	90														
<p>LN0023A</p>  <p>EXPORT MODEL</p> <table border="1" data-bbox="431 1171 731 1225"> <thead> <tr> <th>a</th> <th>b</th> <th>c</th> <th>r</th> </tr> </thead> <tbody> <tr> <td>3.2</td> <td>1.6</td> <td>30</td> <td>90</td> </tr> </tbody> </table> <p>2pcs.</p>	a	b	c	r	3.2	1.6	30	90	<p>FN-0029</p>  <p>LN0029 (Rear)</p> <table border="1" data-bbox="1089 1171 1388 1225"> <thead> <tr> <th>a</th> <th>b</th> <th>c</th> <th>r</th> </tr> </thead> <tbody> <tr> <td>2.9</td> <td>1.6</td> <td>35</td> <td>90</td> </tr> </tbody> </table> <p>2pcs.</p>	a	b	c	r	2.9	1.6	35	90
a	b	c	r														
3.2	1.6	30	90														
a	b	c	r														
2.9	1.6	35	90														
<p>FN-0024</p>  <p>LN0024 (Rear)</p> <table border="1" data-bbox="413 1495 713 1549"> <thead> <tr> <th>a</th> <th>b</th> <th>c</th> <th>r</th> </tr> </thead> <tbody> <tr> <td>2.9</td> <td>1.6</td> <td>24.5</td> <td>82.5</td> </tr> </tbody> </table> <p>4pcs.</p>	a	b	c	r	2.9	1.6	24.5	82.5	<p>LN0029A</p>  <table border="1" data-bbox="1089 1495 1388 1549"> <thead> <tr> <th>a</th> <th>b</th> <th>c</th> <th>r</th> </tr> </thead> <tbody> <tr> <td>2.9</td> <td>1.6</td> <td>35</td> <td>90</td> </tr> </tbody> </table> <p>2pcs.</p>	a	b	c	r	2.9	1.6	35	90
a	b	c	r														
2.9	1.6	24.5	82.5														
a	b	c	r														
2.9	1.6	35	90														
<p>FN-0025</p>  <p>LN0025 (Rear)</p> <table border="1" data-bbox="413 1812 713 1865"> <thead> <tr> <th>a</th> <th>b</th> <th>c</th> <th>r</th> </tr> </thead> <tbody> <tr> <td>3.2</td> <td>1.6</td> <td>30</td> <td>90</td> </tr> </tbody> </table> <p>4pcs.</p>	a	b	c	r	3.2	1.6	30	90	<p>FN-0030</p>  <p>LN0030 (Rear)</p> <table border="1" data-bbox="1089 1812 1388 1865"> <thead> <tr> <th>a</th> <th>b</th> <th>c</th> <th>r</th> </tr> </thead> <tbody> <tr> <td>2.9</td> <td>1.6</td> <td>25</td> <td>90</td> </tr> </tbody> </table> <p>4pcs.</p>	a	b	c	r	2.9	1.6	25	90
a	b	c	r														
3.2	1.6	30	90														
a	b	c	r														
2.9	1.6	25	90														
<p>FN-0026</p>  <p>LN0026 (Front)</p> <table border="1" data-bbox="413 2136 713 2189"> <thead> <tr> <th>a</th> <th>b</th> <th>c</th> <th>r</th> </tr> </thead> <tbody> <tr> <td>3.2</td> <td>2</td> <td>35</td> <td>90</td> </tr> </tbody> </table> <p>4pcs.</p>	a	b	c	r	3.2	2	35	90	<p>FN-0031</p>  <p>EXPORT MODEL</p> <p>LN0031 (Rear)</p> <table border="1" data-bbox="1089 2136 1388 2189"> <thead> <tr> <th>a</th> <th>b</th> <th>c</th> <th>r</th> </tr> </thead> <tbody> <tr> <td>4</td> <td>2</td> <td>35</td> <td>114.3</td> </tr> </tbody> </table> <p>4pcs.</p>	a	b	c	r	4	2	35	114.3
a	b	c	r														
3.2	2	35	90														
a	b	c	r														
4	2	35	114.3														

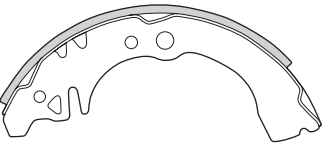
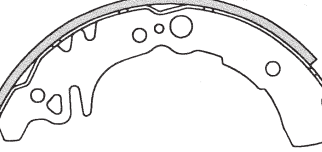
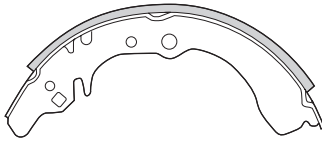
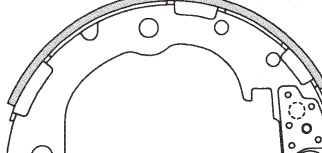
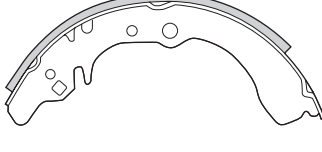
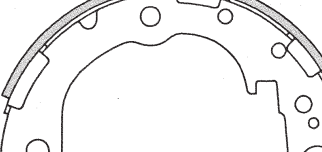
<p>FN-0032</p>  <p>LN0032(Rear)</p> <table border="1" data-bbox="415 531 713 589"> <thead> <tr> <th>a</th> <th>b</th> <th>c</th> <th>r</th> </tr> </thead> <tbody> <tr> <td>2.9</td> <td>1.6</td> <td>30</td> <td>100</td> </tr> </tbody> </table> <p>4pcs.</p>	a	b	c	r	2.9	1.6	30	100	<p>FN-0036</p>  <p>LN0036 (Rear)</p> <table border="1" data-bbox="1084 531 1381 589"> <thead> <tr> <th>a</th> <th>b</th> <th>c</th> <th>r</th> </tr> </thead> <tbody> <tr> <td>2.9</td> <td>1.6</td> <td>30</td> <td>90</td> </tr> </tbody> </table> <p>2pcs.</p>	a	b	c	r	2.9	1.6	30	90
a	b	c	r														
2.9	1.6	30	100														
a	b	c	r														
2.9	1.6	30	90														
<p>FN-0033</p>  <p>EXPORT MODEL</p> <p>LN0033(Front)</p> <table border="1" data-bbox="415 857 713 915"> <thead> <tr> <th>a</th> <th>b</th> <th>c</th> <th>r</th> </tr> </thead> <tbody> <tr> <td>3.2</td> <td>2</td> <td>35</td> <td>90</td> </tr> </tbody> </table> <p>4pcs.</p>	a	b	c	r	3.2	2	35	90	 <p>LN0036A</p> <table border="1" data-bbox="1084 857 1381 915"> <thead> <tr> <th>a</th> <th>b</th> <th>c</th> <th>r</th> </tr> </thead> <tbody> <tr> <td>2.9</td> <td>1.6</td> <td>30</td> <td>90</td> </tr> </tbody> </table> <p>2pcs.</p>	a	b	c	r	2.9	1.6	30	90
a	b	c	r														
3.2	2	35	90														
a	b	c	r														
2.9	1.6	30	90														
<p>FN-0034</p>  <p>LN0034 (Rear)</p> <table border="1" data-bbox="415 1174 713 1232"> <thead> <tr> <th>a</th> <th>b</th> <th>c</th> <th>r</th> </tr> </thead> <tbody> <tr> <td>2.9</td> <td>1.6</td> <td>25</td> <td>90</td> </tr> </tbody> </table> <p>2pcs.</p>	a	b	c	r	2.9	1.6	25	90	<p>FN-0037</p>  <p>LN0037(Rear)</p> <table border="1" data-bbox="1084 1174 1381 1232"> <thead> <tr> <th>a</th> <th>b</th> <th>c</th> <th>r</th> </tr> </thead> <tbody> <tr> <td>2.9</td> <td>1.6</td> <td>25</td> <td>90</td> </tr> </tbody> </table> <p>4pcs.</p>	a	b	c	r	2.9	1.6	25	90
a	b	c	r														
2.9	1.6	25	90														
a	b	c	r														
2.9	1.6	25	90														
<p>LN0034A</p>  <table border="1" data-bbox="415 1495 713 1554"> <thead> <tr> <th>a</th> <th>b</th> <th>c</th> <th>r</th> </tr> </thead> <tbody> <tr> <td>2.9</td> <td>1.6</td> <td>25</td> <td>90</td> </tr> </tbody> </table> <p>2pcs.</p>	a	b	c	r	2.9	1.6	25	90	<p>FN-0038</p>  <p>LN0038(Rear)</p> <table border="1" data-bbox="1084 1495 1381 1554"> <thead> <tr> <th>a</th> <th>b</th> <th>c</th> <th>r</th> </tr> </thead> <tbody> <tr> <td>2.9</td> <td>1.6</td> <td>35</td> <td>90</td> </tr> </tbody> </table> <p>4pcs.</p>	a	b	c	r	2.9	1.6	35	90
a	b	c	r														
2.9	1.6	25	90														
a	b	c	r														
2.9	1.6	35	90														
<p>FN-0035</p>  <p>LN0035 (Rear)</p> <table border="1" data-bbox="415 1807 713 1865"> <thead> <tr> <th>a</th> <th>b</th> <th>c</th> <th>r</th> </tr> </thead> <tbody> <tr> <td>2.9</td> <td>1.6</td> <td>35</td> <td>100</td> </tr> </tbody> </table> <p>2pcs.</p>	a	b	c	r	2.9	1.6	35	100	<p>FN-0039</p>  <p>LN0039 (Parking)</p> <table border="1" data-bbox="1084 1807 1381 1865"> <thead> <tr> <th>a</th> <th>b</th> <th>c</th> <th>r</th> </tr> </thead> <tbody> <tr> <td>4.5</td> <td>2</td> <td>35</td> <td>89</td> </tr> </tbody> </table> <p>1pc.</p>	a	b	c	r	4.5	2	35	89
a	b	c	r														
2.9	1.6	35	100														
a	b	c	r														
4.5	2	35	89														
<p>LN0035A</p>  <table border="1" data-bbox="415 2124 713 2182"> <thead> <tr> <th>a</th> <th>b</th> <th>c</th> <th>r</th> </tr> </thead> <tbody> <tr> <td>2.9</td> <td>1.6</td> <td>35</td> <td>100</td> </tr> </tbody> </table> <p>2pcs.</p>	a	b	c	r	2.9	1.6	35	100	<p>LN0015</p>  <table border="1" data-bbox="1084 2124 1381 2182"> <thead> <tr> <th>a</th> <th>b</th> <th>c</th> <th>r</th> </tr> </thead> <tbody> <tr> <td>4.5</td> <td>2</td> <td>35</td> <td>89</td> </tr> </tbody> </table> <p>1pc.</p>	a	b	c	r	4.5	2	35	89
a	b	c	r														
2.9	1.6	35	100														
a	b	c	r														
4.5	2	35	89														

FN-0040

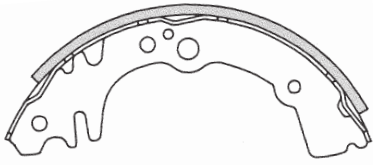

LN0040(Rear)	a	b	c	r	4pcs.
	2.9	1.6	24.5	82.5	

FN-0041

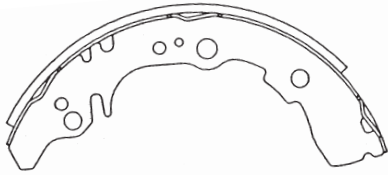

LN0041(Rear)	a	b	c	r	4pcs.
	2.9	1.6	35	100	

FN-0042



LN0042(Rear)	a	b	c	r	4pcs.
	2.9	1.6	24.5	82.5	

FN-0043

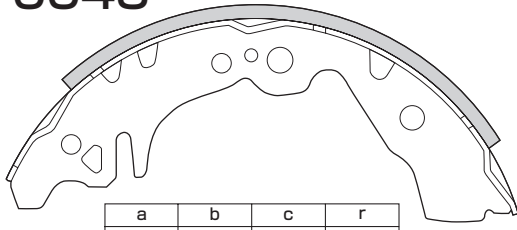

LN0043(Rear)	a	b	c	r	4pcs.
	2.9	1.6	25	90	

FN-0044

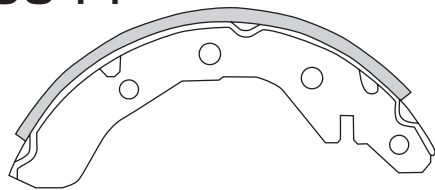

LN0044	a	b	c	r	4pcs.
	3.2	1.6	24.5	82.5	

FN-K901

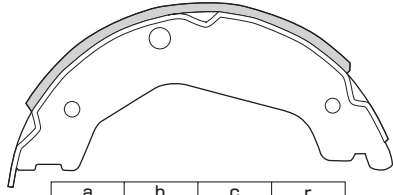

LNK901
(Parking)

a	b	c	r
4	2	39.8	95

4pcs.

FN-K902

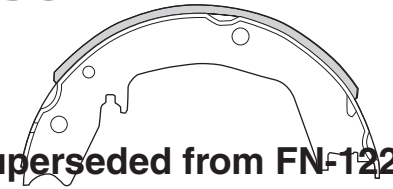

Superseded from FN-12273

LNK902
(Parking)

a	b	c	r
6	2	40.2	94.6

2pcs.

Superseded from FN-12273

LNK903

a	b	c	r
6	2	40.2	94.6

1pc.

Superseded from FN-12273

LNK904

a	b	c	r
6	2	40.2	94.6

1pc.

FN-K905

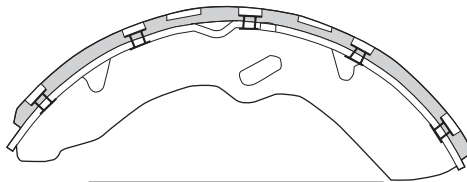

LNK905

a	b	c	r
6	4	85	160

4pcs.

New Products

New Products

DISC BRAKE PADS

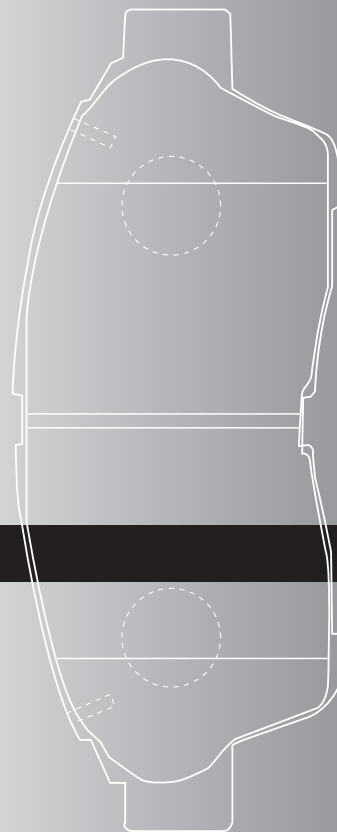

DP ILLUSTRATIONS

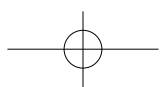
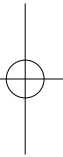
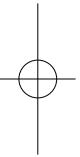
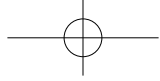
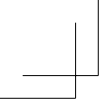

HN-No.	W	H	T	AKNo.	HN-No.	W	H	T	AKNo.
				MKNo.					MKNo.
HN-014	78.8	55.5	14.5		HN-020	63.3	52.0	14.5	
				D2006					
HN-034	78.4	69.2	14.6	AN-25K D1007-02	HN-038	58.0	55.0	14.2	AN-37K D1005
HN-042						132.8	50.5	15.0	AN-49K
						120.5	51.0	15.0	D2007
HN-045	78.7	60.0	14.2	AN-38K D5003	HN-052-2	130.0	51.0	15.4	AN-77K D2011-02
HN-056	108.8	44.1	13.9	AN-72K D2014-02	HN-057	108.0	39.0	14.0	A-48K D6003

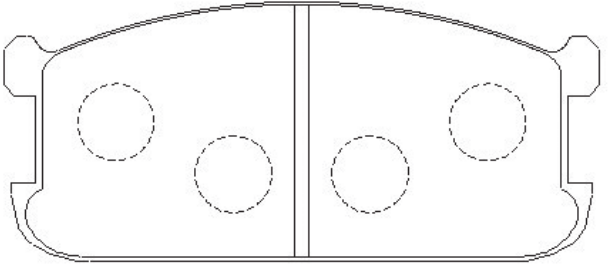
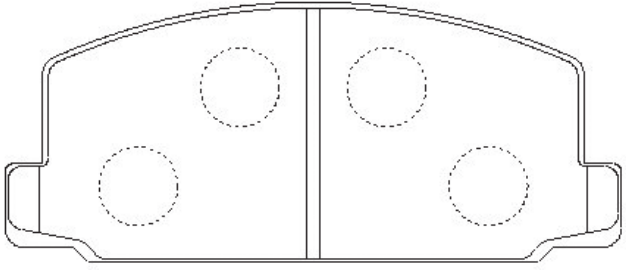
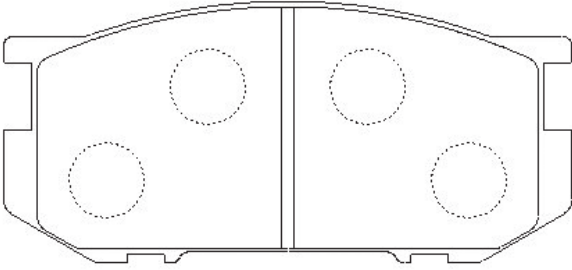
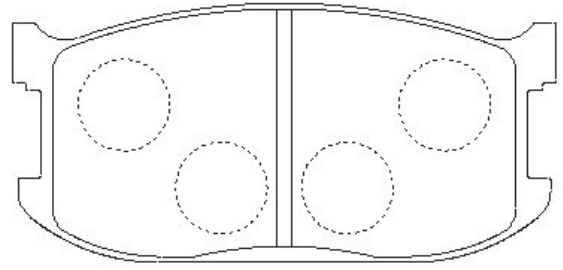
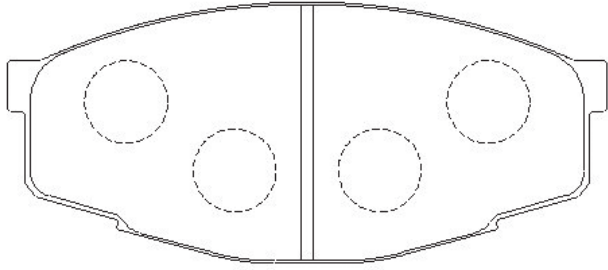
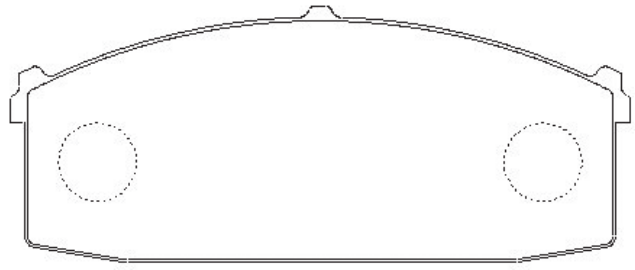
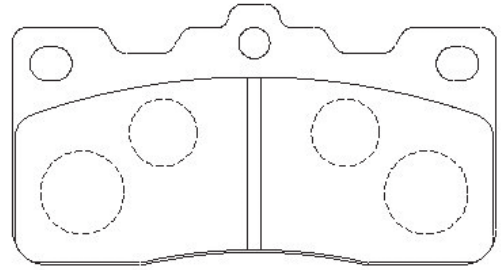
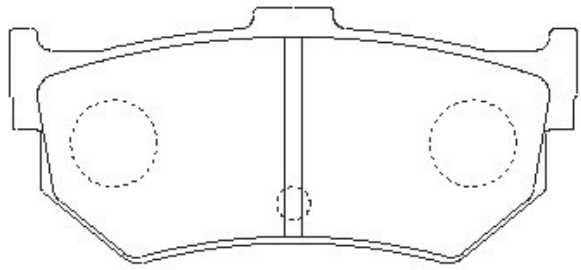
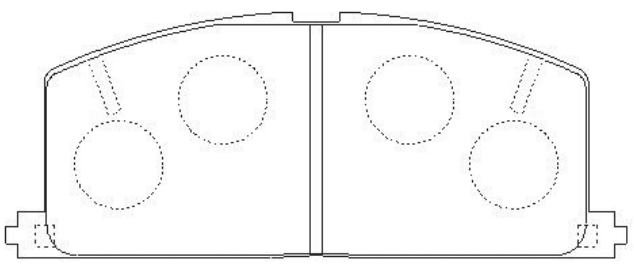
HN-No.	W	H	T	AKNo.	HN-No.	W	H	T	AKNo.
				MKNo.					MKNo.
HN-066	109.0	47.5	15.2	A-86K					
				D6004					
									
HN-067					109.2	46.1	13.8	AN-80K	
					106.7	49.0	13.8	D2015-02	
									
HN-070	95.0	45.3	14.3	AN-93K	HN-071	116.0	51.0	15.3	AN-103K
				D3007-02					D2018-02
									
HN-072	111.5	46.0	14.2	AN-88K	HN-074	92.9	50.2	14.3	AN-31K
				D1012-02					D2024-02
									
HN-076	85.5	39.0	12.8	AN-112K	HN-077C	119.7	47.5	15.0	AN-113K
				D5015-02					D2023-02
<p>※discontinued</p> 									

HN-No.	W	H	T	AKNo.	HN-No.	W	H	T	AKNo.
				MKNo.					MKNo.
HN-078						142.0	53.5	16.3	AN-122K
						142.0	59.0	16.3	D1020-02
※Integrated into HN-132B									
HN-080	108.5	40.0	15.7	AN-107K D1018-02					
HN-081					109.2	49.0	14.7	AN-102K	
					106.7	52.0	14.7	D2021-02	
HN-083	133.0	47.0	15.0	AN-96K D4001-02	HN-084	127.8	57.0	15.3	AN-97K D6014-02
HN-086	107.9	66.0	15.3	AN-50K D2020-02	HN-089	108.0	47.0	14.8	AN-109K D6010-02

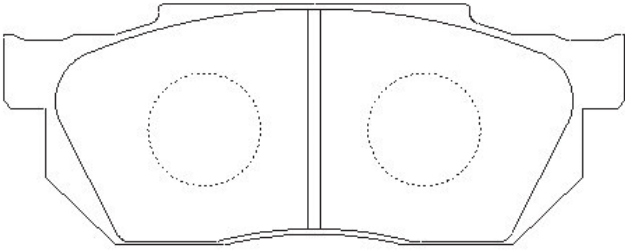
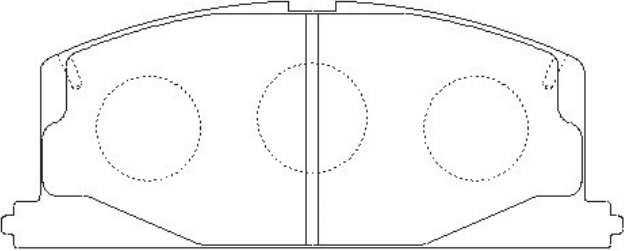
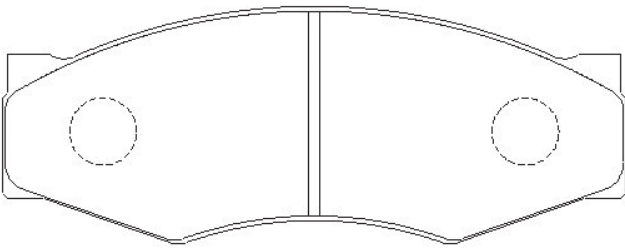
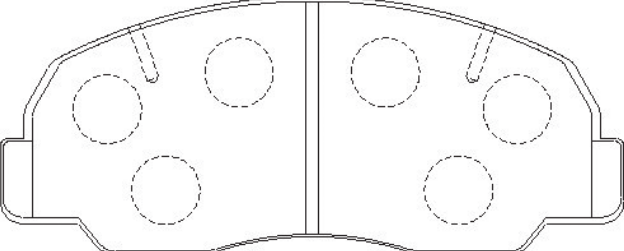
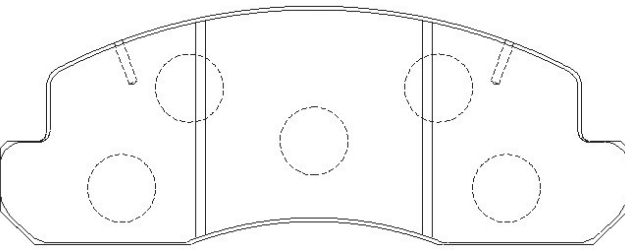
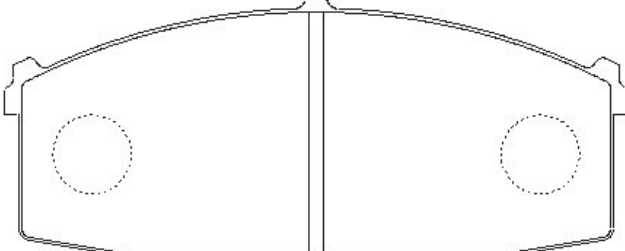
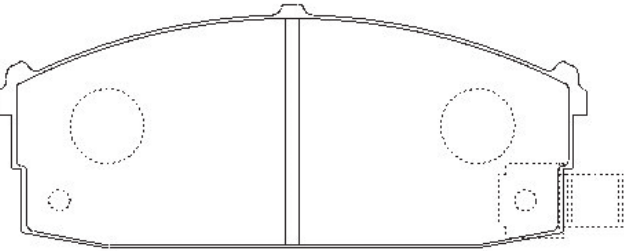
HN-No.	W	H	T	AKNo.	HN-No.	W	H	T	AKNo.
				MKNo.					MKNo.
HN-090	116.0	45.0	14.8	AN-111K	HN-094	119.7	47.5	15.0	AN-115K
				D5011-02					
					※Integrated into HN-077C				
									
HN-095	130.0	48.0	16.7	AN-127K					
				D1025-02					D2068-02
									
HN-099	166.5	63.2	17.9	AN-409WK					
				D2052-02					
									
HN-104					111.5	46.0	14.2	AN-88WK	
								D1028M-02	
									

HN-No.	W	H	T	AKNo.	HN-No.	W	H	T	AKNo.
				MKNo.					MKNo.
HN-105						130.0	48.0	16.7	AN-130WK
									D1031M-02

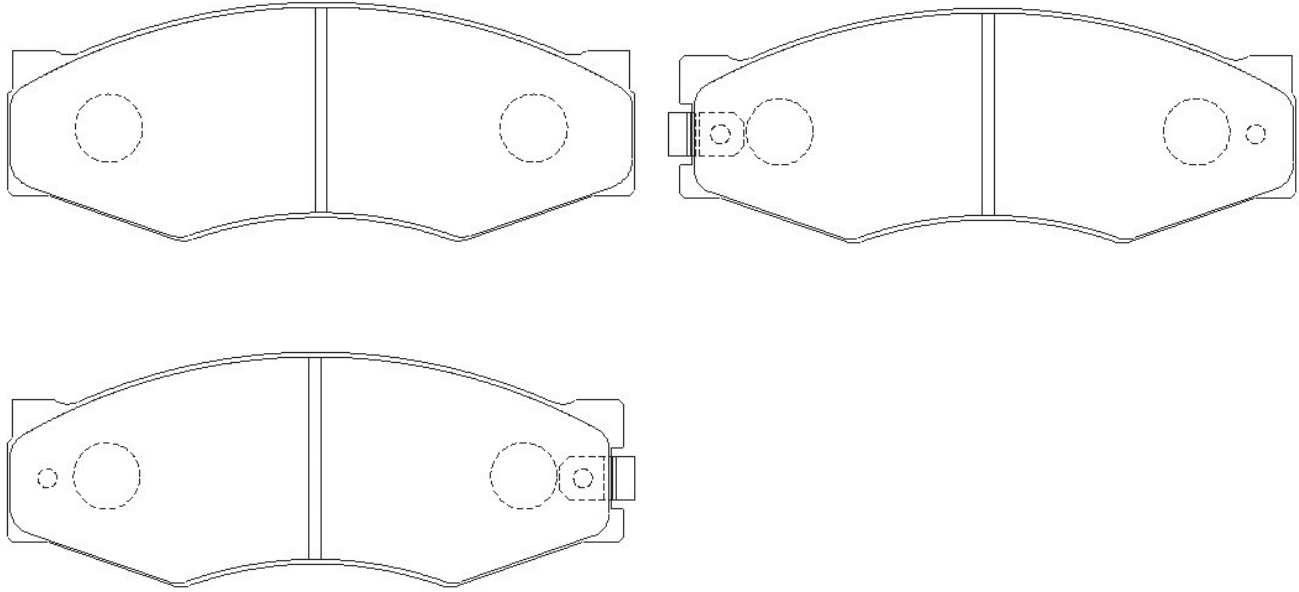

HN-108						108.5	40.0	15.7	AN-107WK
									D1035M-02

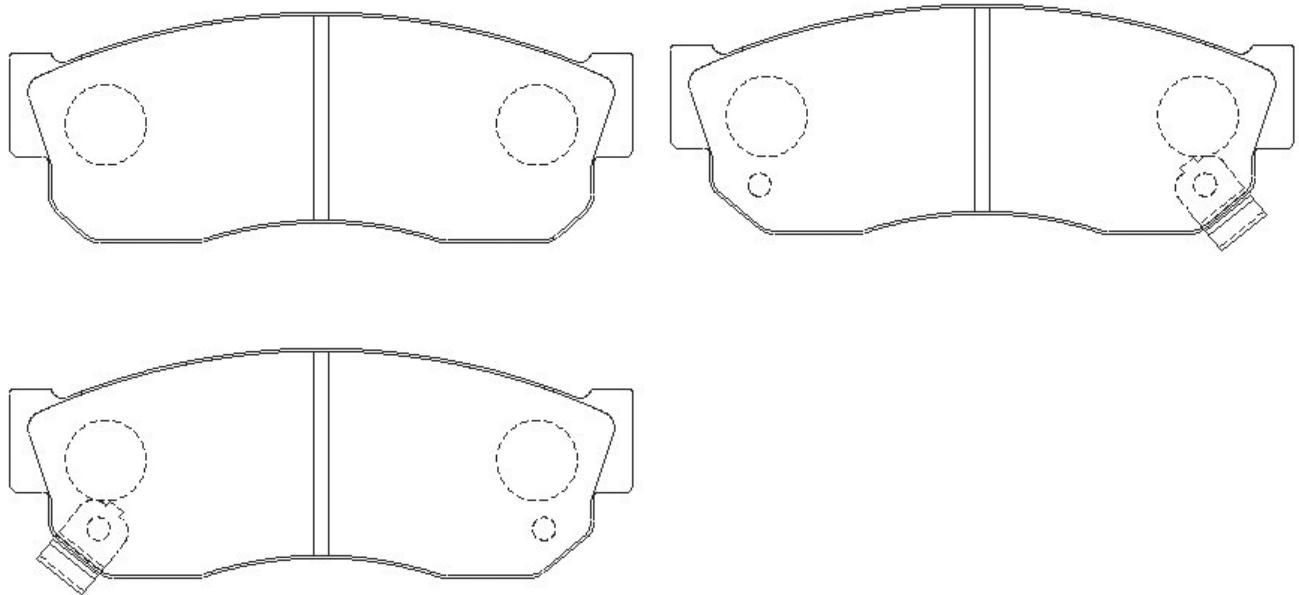

HN-109	98.6	37.0	14.4	AN-126K	HN-110	98.8	44.5	14.4	A-128K
				D2028-02					

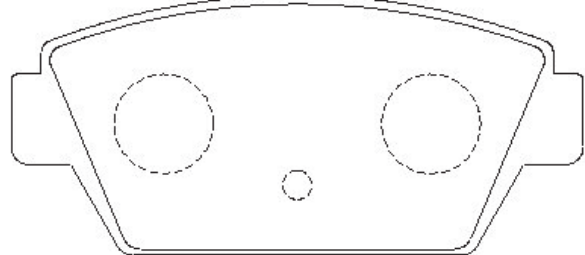
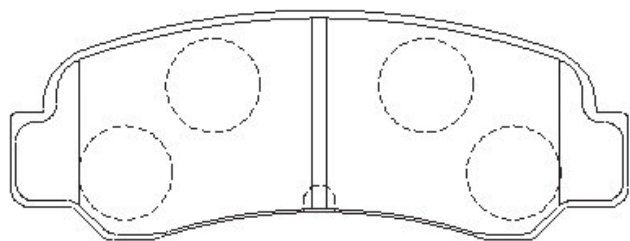

HN-No.	W	H	T	AKNo.	HN-No.	W	H	T	AKNo.
				MKNo.					MKNo.
HN-114	78.7	63.5	13.3	AN-216K	HN-115	107.6	49.5	15.0	AN-138K
				D0004-02					
HN-117						123.0	41.0	15.0	AN-131K
									D9001-02
HN-118		110.5	41.7	15.1	AN-129K				
					D9000-02				
HN-123						98.6	47.2	16.0	AN-146WK
						106.7	46.8	15.0	D2043M-02

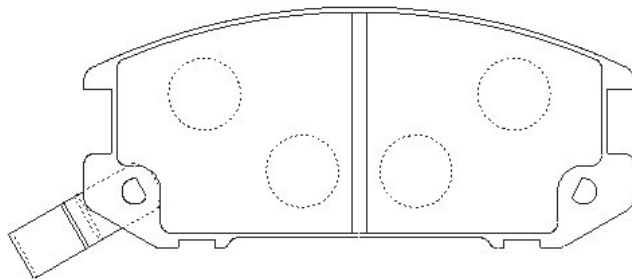
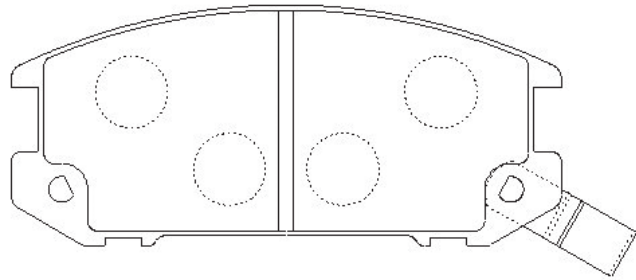
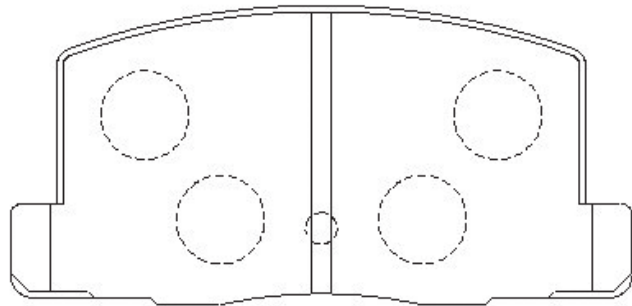
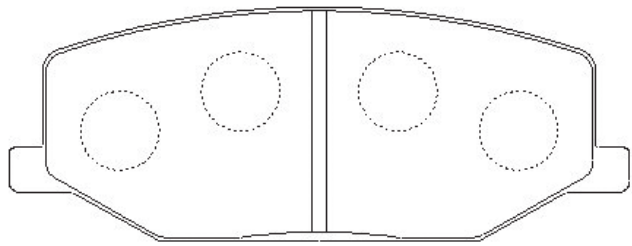
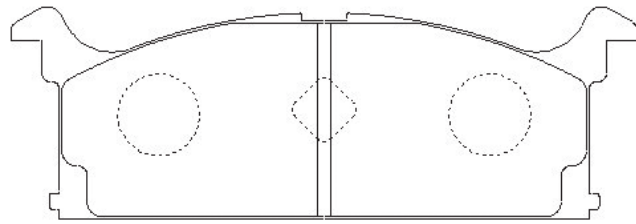
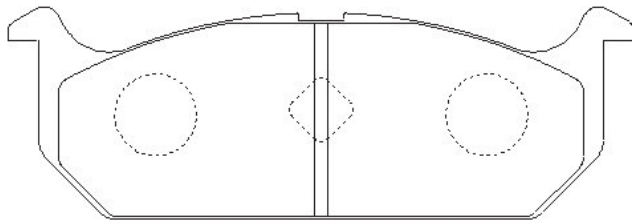
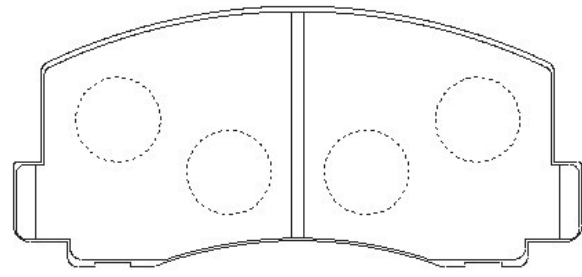
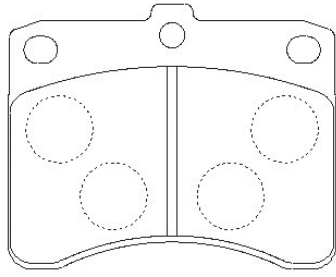

HN-No.	W	H	T	AKNo.	HN-No.	W	H	T	AKNo.
				MKNo.					MKNo.

HN-124	119.4	38.0	15.3	AN-136K
				D5009-02

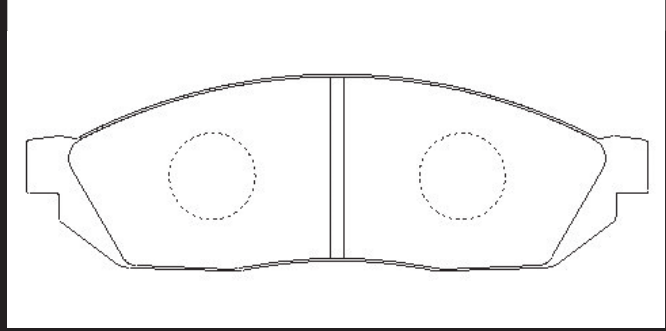

HN-127					127.8	48.5	14.8	AN-211WK
								D5022M-02

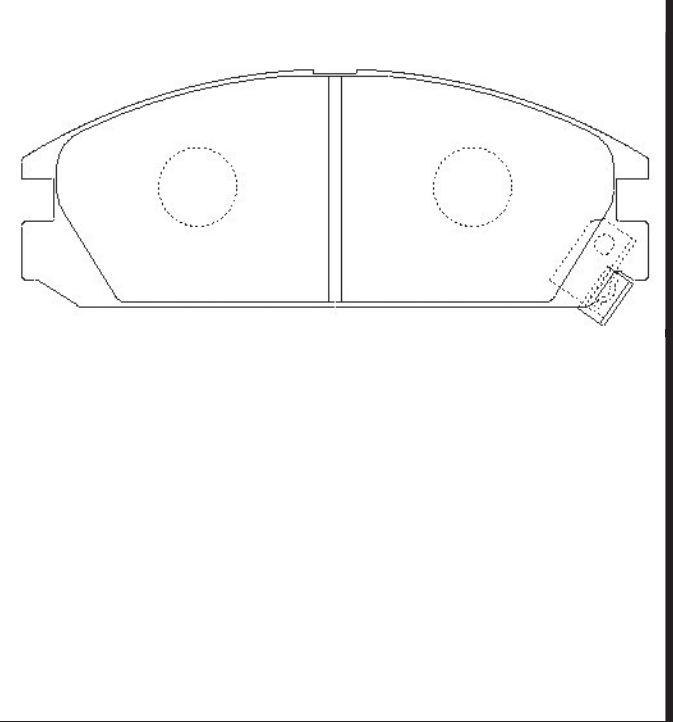
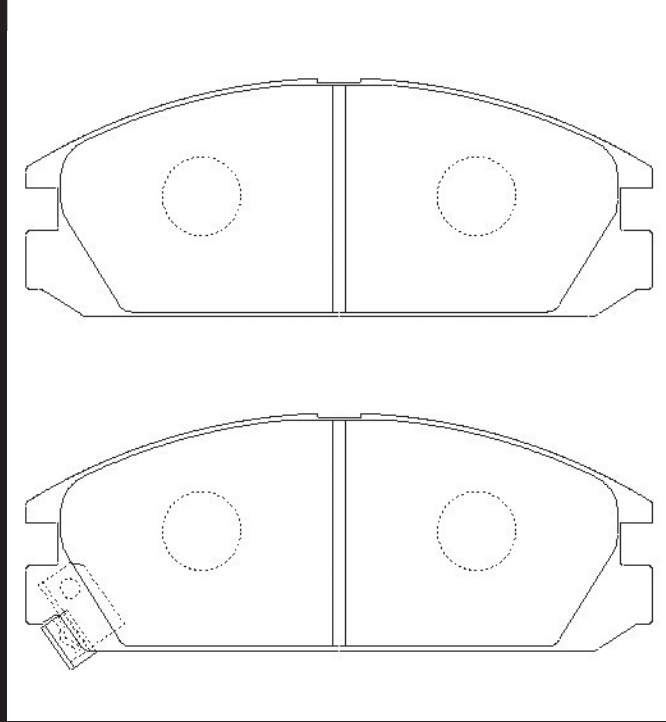

HN-130					85.3	46.0	13.7	AN-263WK
								D1087M-02

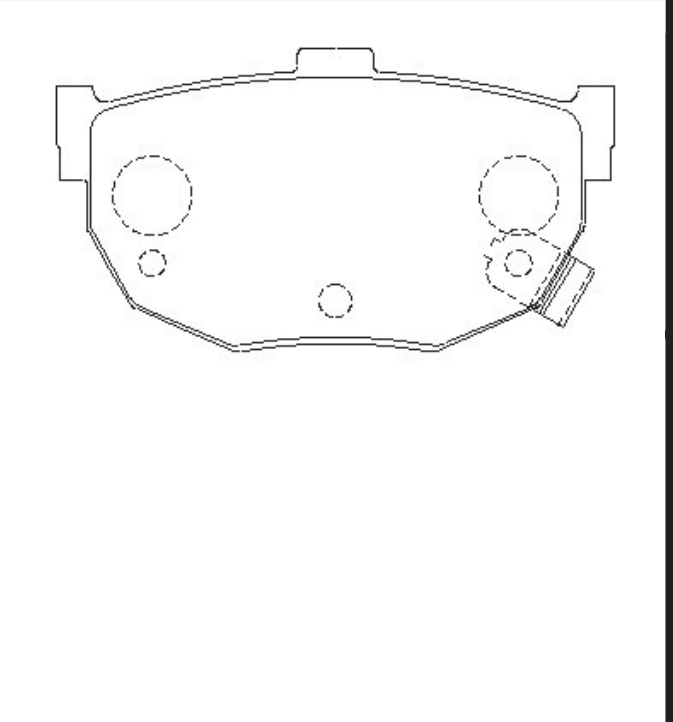
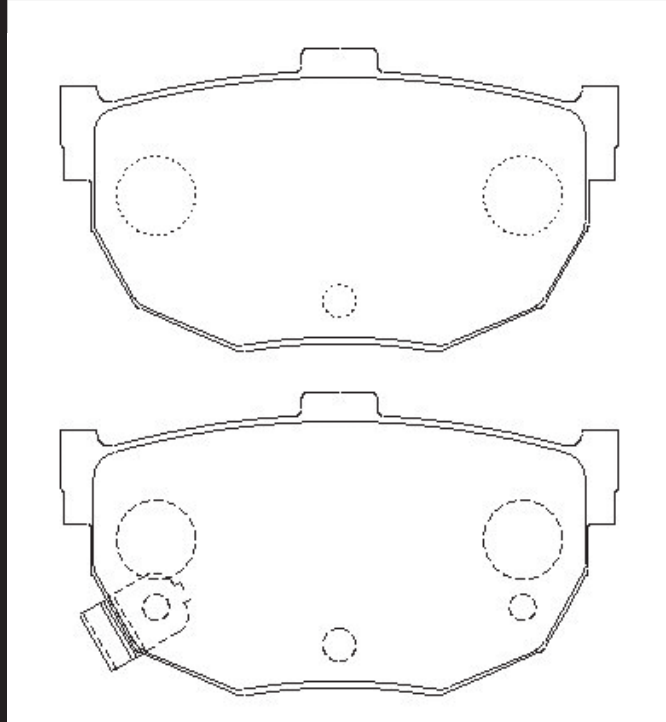

HN-No.	W	H	T	AKNo.	HN-No.	W	H	T	AKNo.
				MKNo.					MKNo.
HN-131						108.0	45.0	15.7	AN-120WK
									D1055M-02

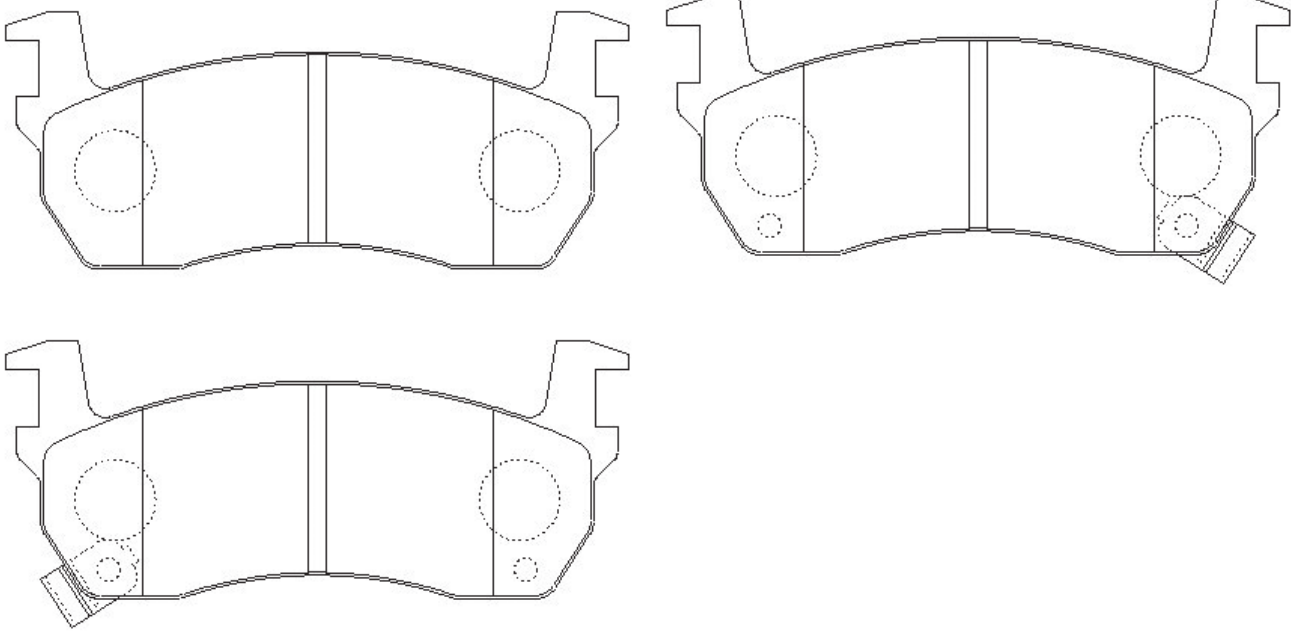

HN-132	W	H	T	AKNo.
	142.0	53.5	16.3	D1026

※Integrated into HN-132B

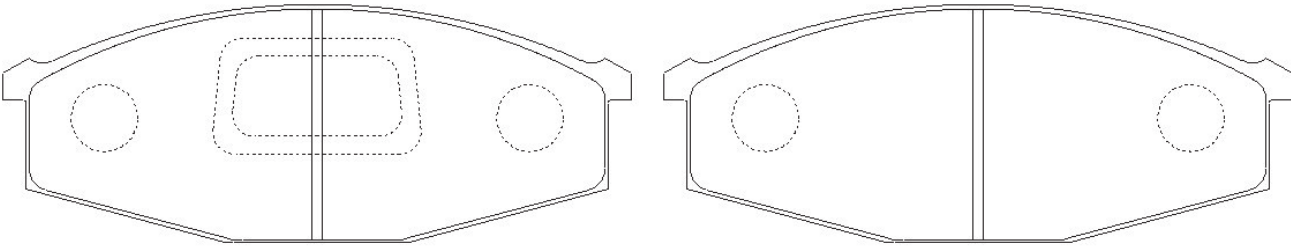

HN-132B	W	H	T	AKNo.
	142.0	53.5	16.3	AN-390K D1073-02

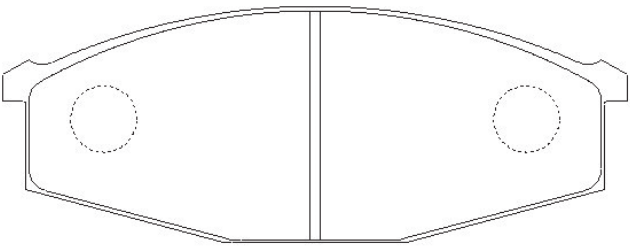

HN-No.	W	H	T	AKNo.	HN-No.	W	H	T	AKNo.
				MKNo.					MKNo.
HN-133				98.7					AN-119WK
				98.7					35.5

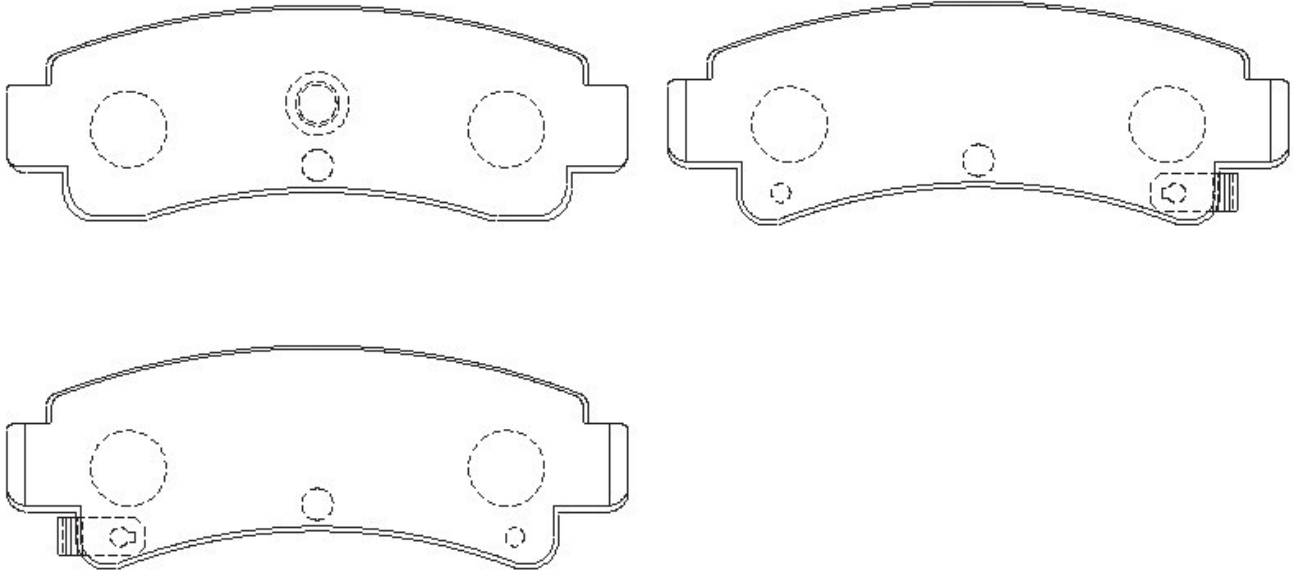

HN-134				97.0					AN-205K
				132.0					44.8

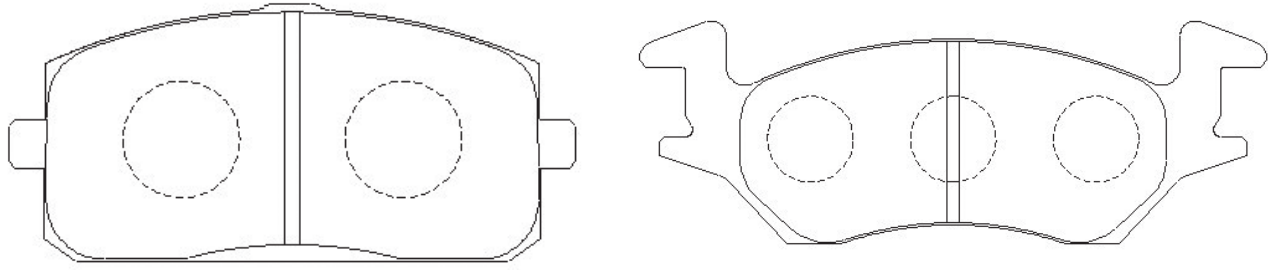

HN-136				107.6					AN-464WK
									42.5

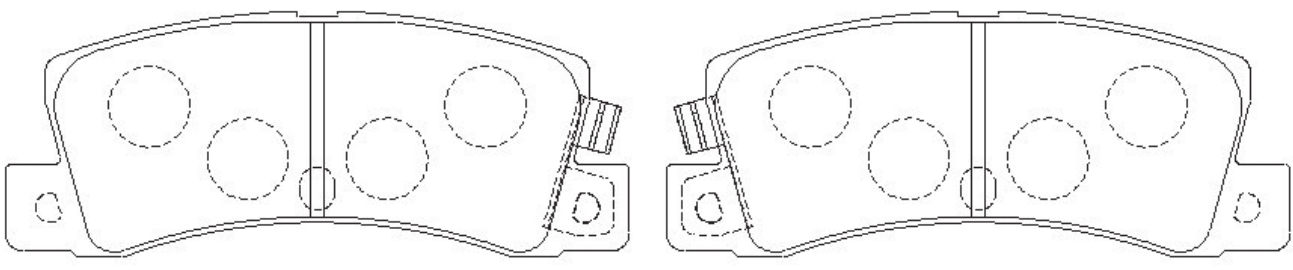

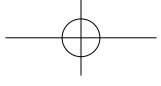

HN-No.	W	H	T	AKNo.	HN-No.	W	H	T	AKNo.
				MKNo.					MKNo.

HN-137						160.6	49.5	16.8	AN-212WK
									D1063M-02

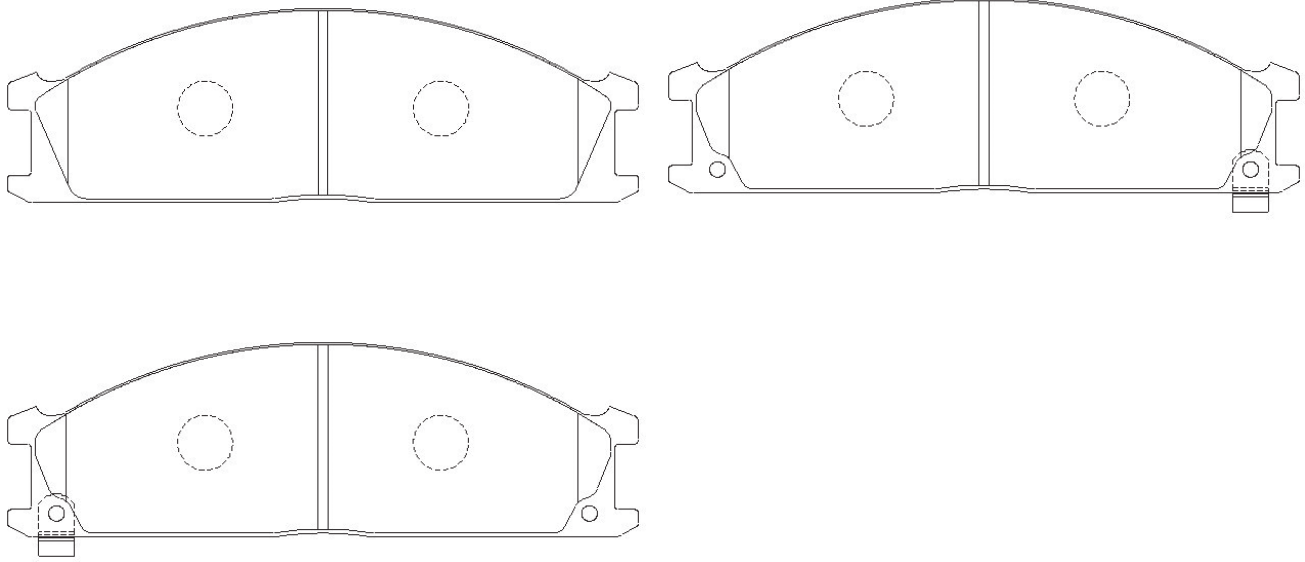

HN-138						91.6	64.1	14.8	AN-208WK
						91.6	64.1	14.8	D3028M-02

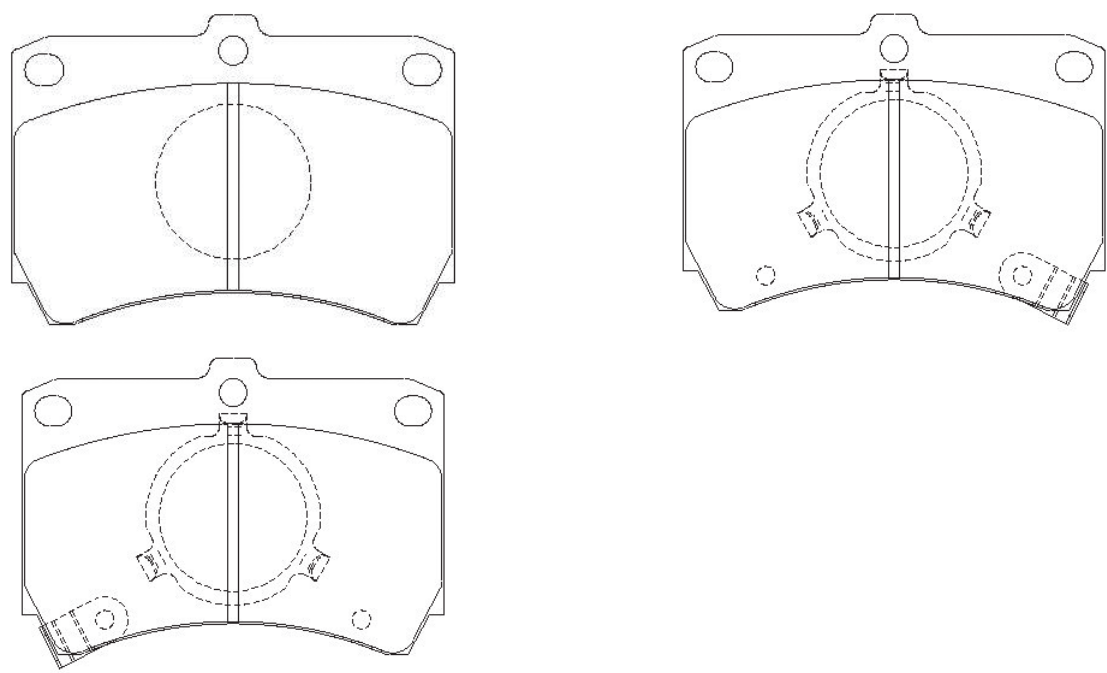

HN-140	95.0	45.5	14.4	AN-206K					
				D4010-02					

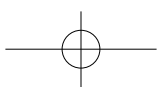
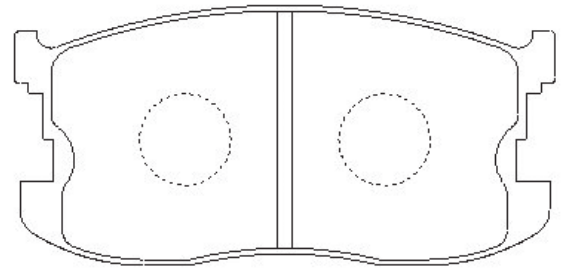

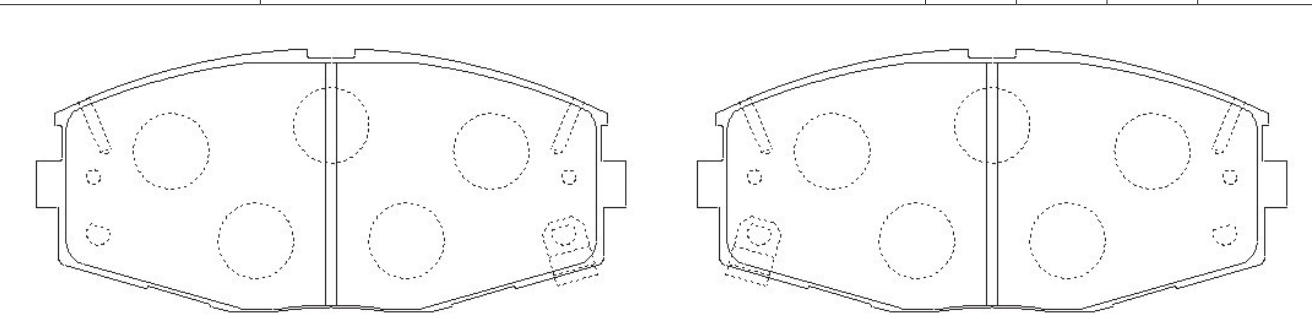
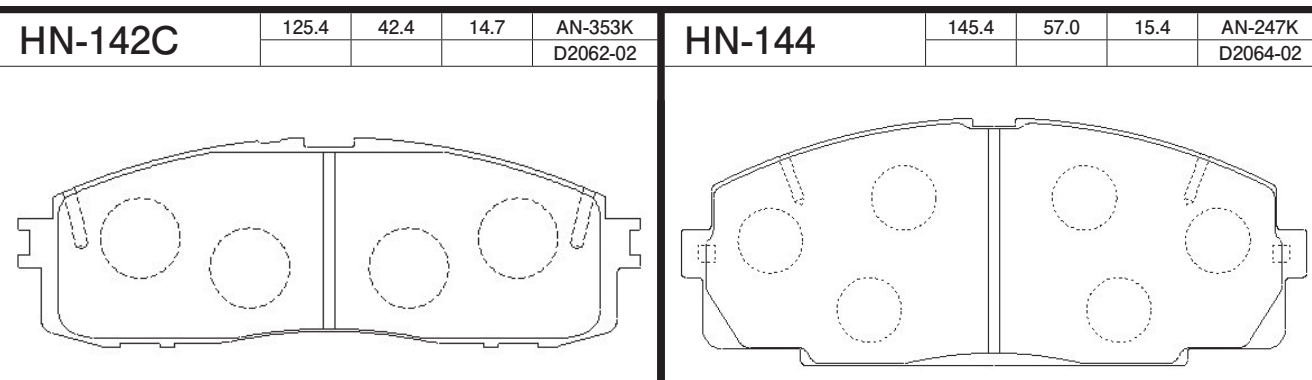
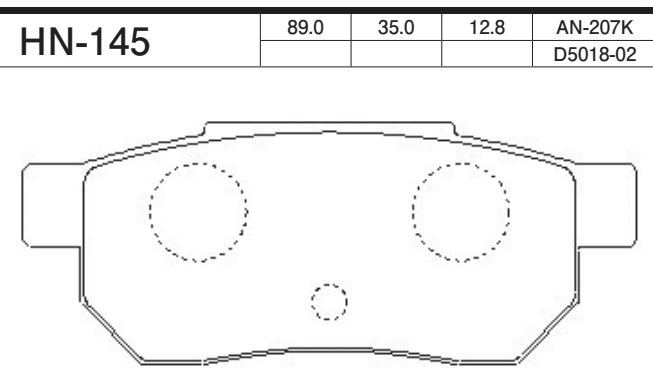
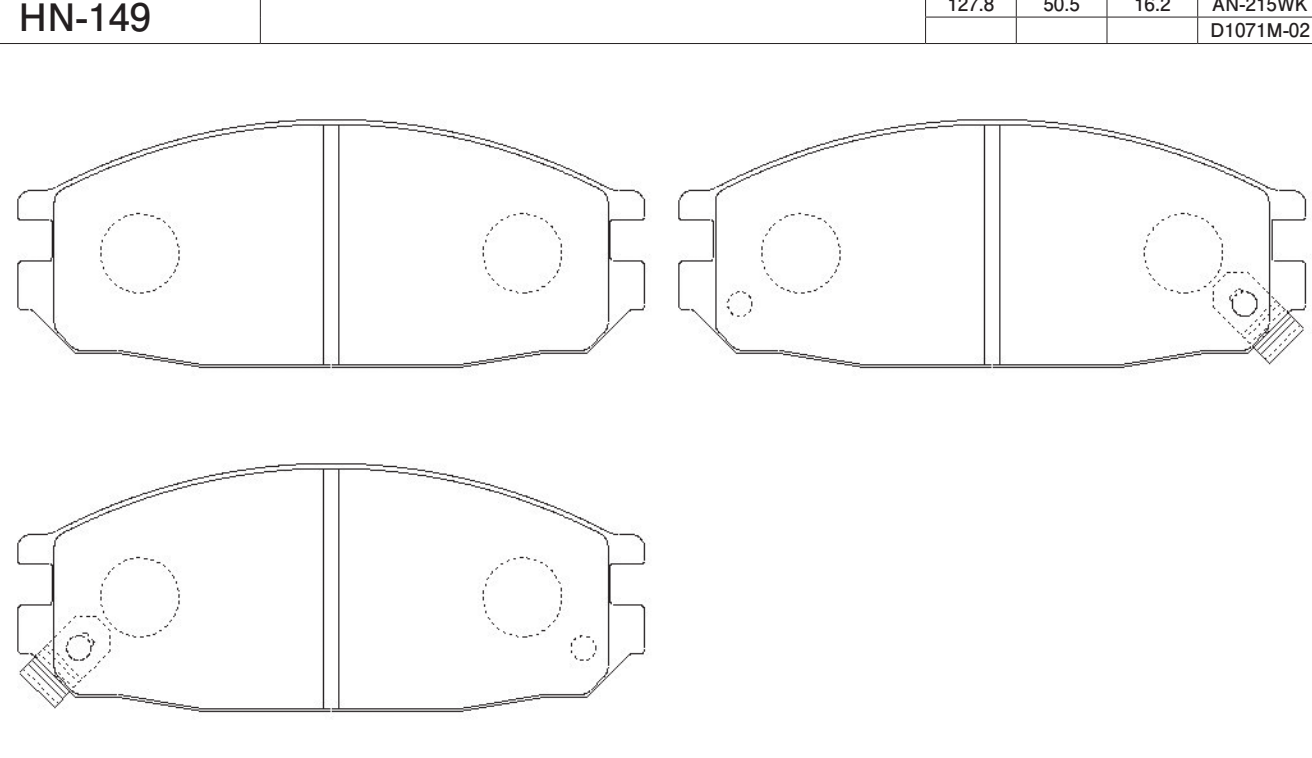
HN-No.	W	H	T	AKNo.	HN-No.	W	H	T	AKNo.
				MKNo.					MKNo.
HN-141						125.4	56.0	15.3	AN-226WK
									D2070M-02
									
HN-142C	125.4	42.4	14.7	AN-353K	HN-144	145.4	57.0	15.4	AN-247K
				D2062-02					D2064-02
									
HN-145	89.0	35.0	12.8	AN-207K					
				D5018-02					
									
HN-149						127.8	50.5	16.2	AN-215WK
									D1071M-02
									

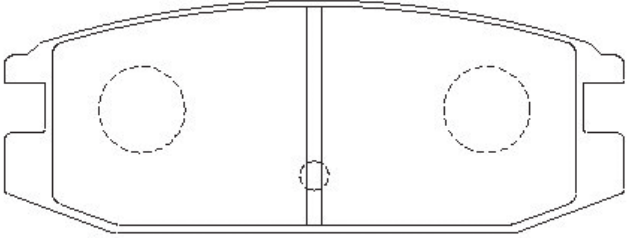
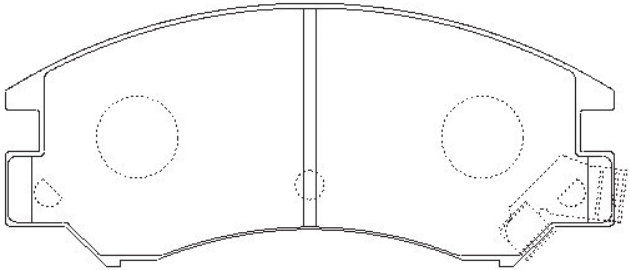
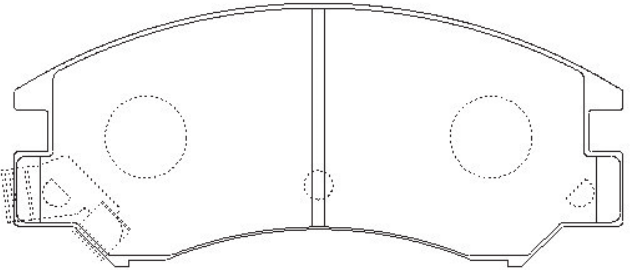
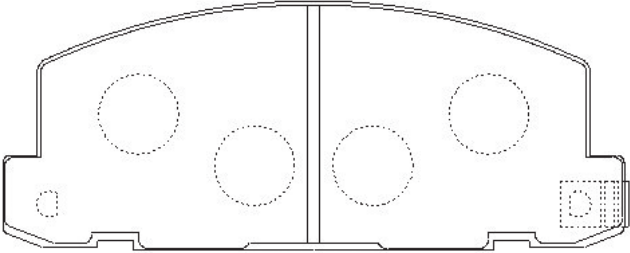
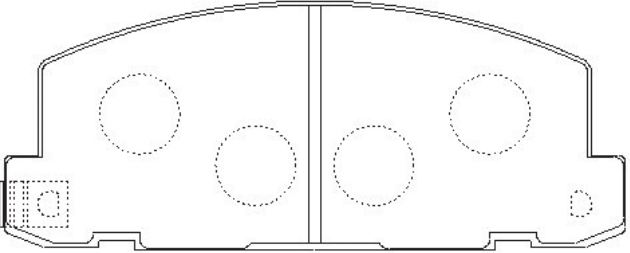
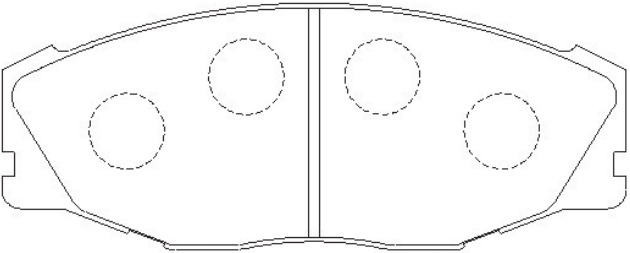
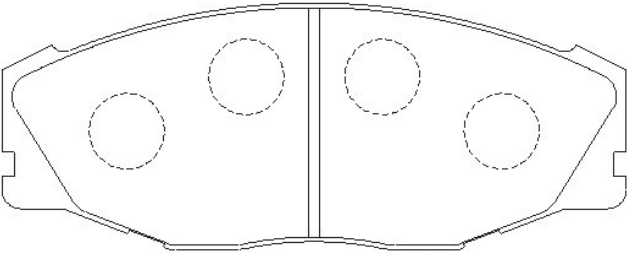
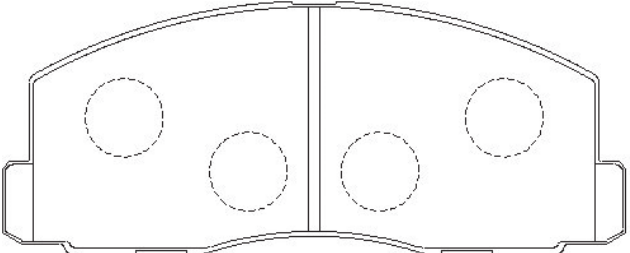
HN-No.	W	H	T	AKNo.	HN-No.	W	H	T	AKNo.
				MKNo.					MKNo.
HN-152	107.9	40.5	12.9	AN-200K					
				D6013-02					
									
HN-153						127.1	54.8	17.3	AN-147WK
									D7011M-02
									
HN-156						120.7	48.5	15.3	AN-137WK
									D4014M
									
HN-157	133.2	52.5	14.8	AN-261K	HN-157-2	133.2	52.5	15.7	A-SM261K
				D2067-02					D2067-TX
									
HN-158	128.0	51.8	14.9	AN-201K					
				D6017-02					
									

HN-No.	W	H	T	AKNo.	HN-No.	W	H	T	AKNo.
				MKNo.					MKNo.
HN-162									AN-274WK
									129.0

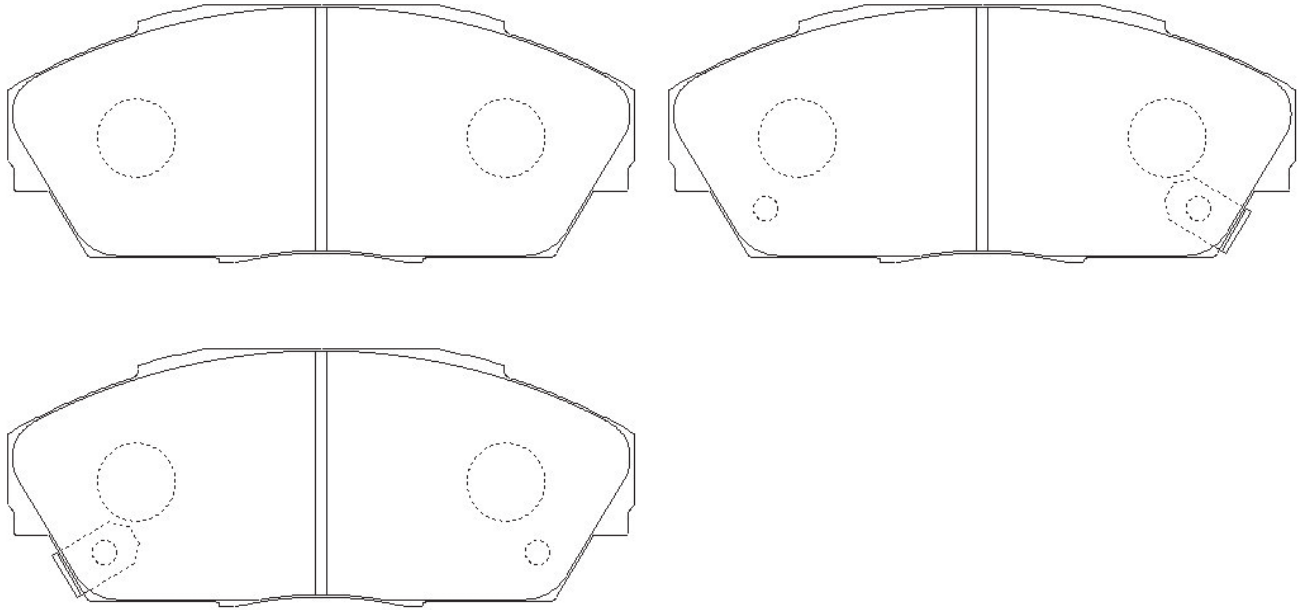

HN-164	104.0	40.5	14.3	AN-134K
				D5014-02

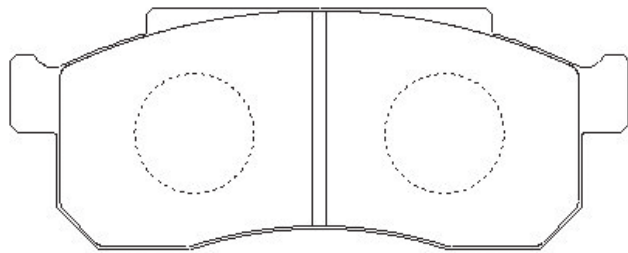

HN-165									AN-234WK
									78.6

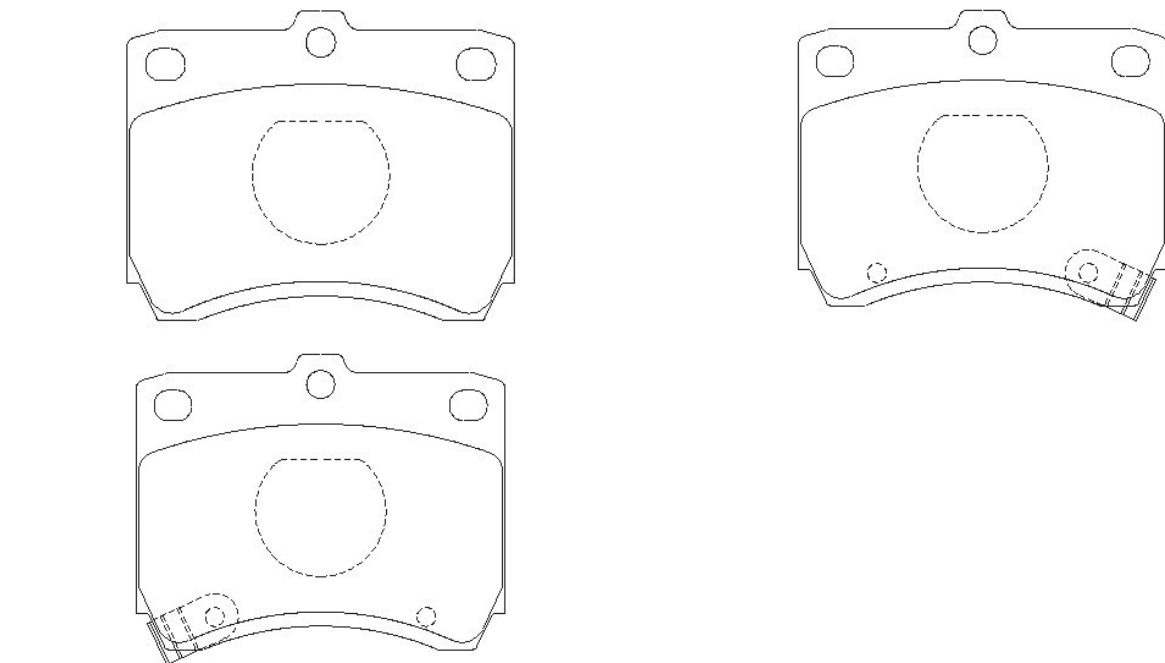

HN-No.	W	H	T	AKNo.	HN-No.	W	H	T	AKNo.
				MKNo.					MKNo.
HN-166	140.1	55.0	15.4	AN-271K	HN-167	116.1	54.5	15.3	AN-241K
				D2063-02					

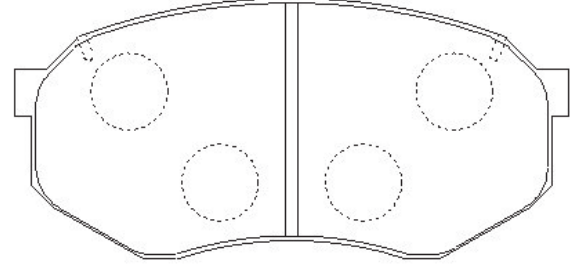
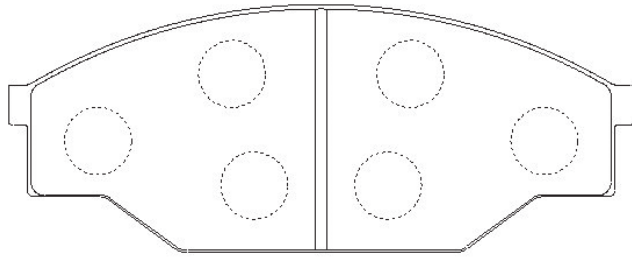

HN-168					117.0	42.2	12.7	AN-242WK
								D3044M-02

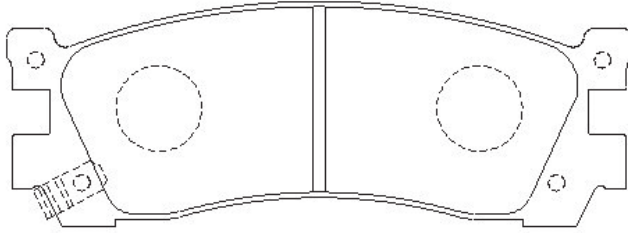
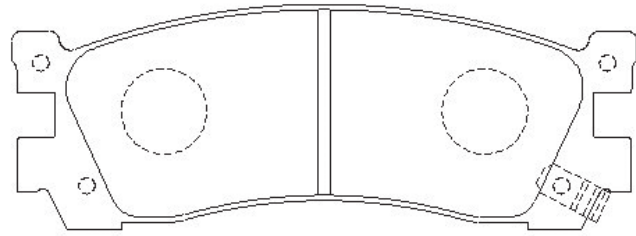
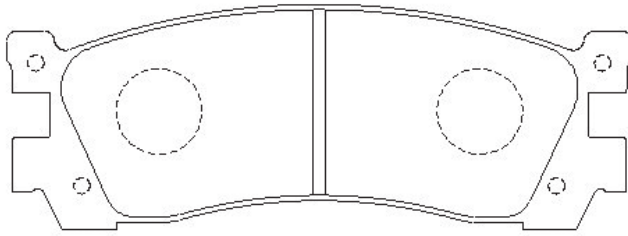

HN-169					107.4	44.5	14.8	AN-245WK
								D9005M-02

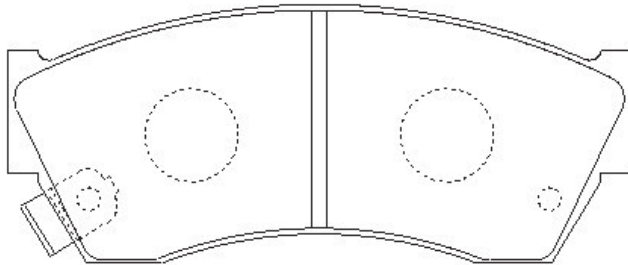
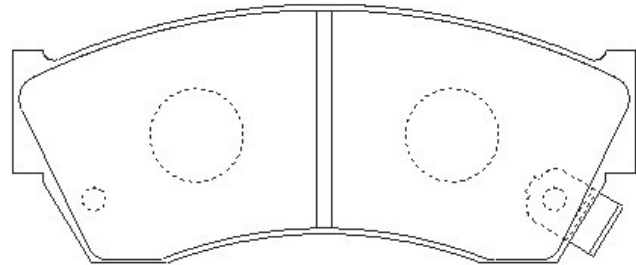
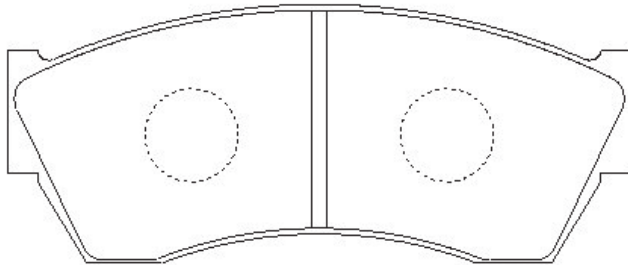

HN-No.	W	H	T	AKNo.	HN-No.	W	H	T	AKNo.
				MKNo.					MKNo.
HN-172						127.8	57.0	16.2	AN-233WK
									D6018M-02

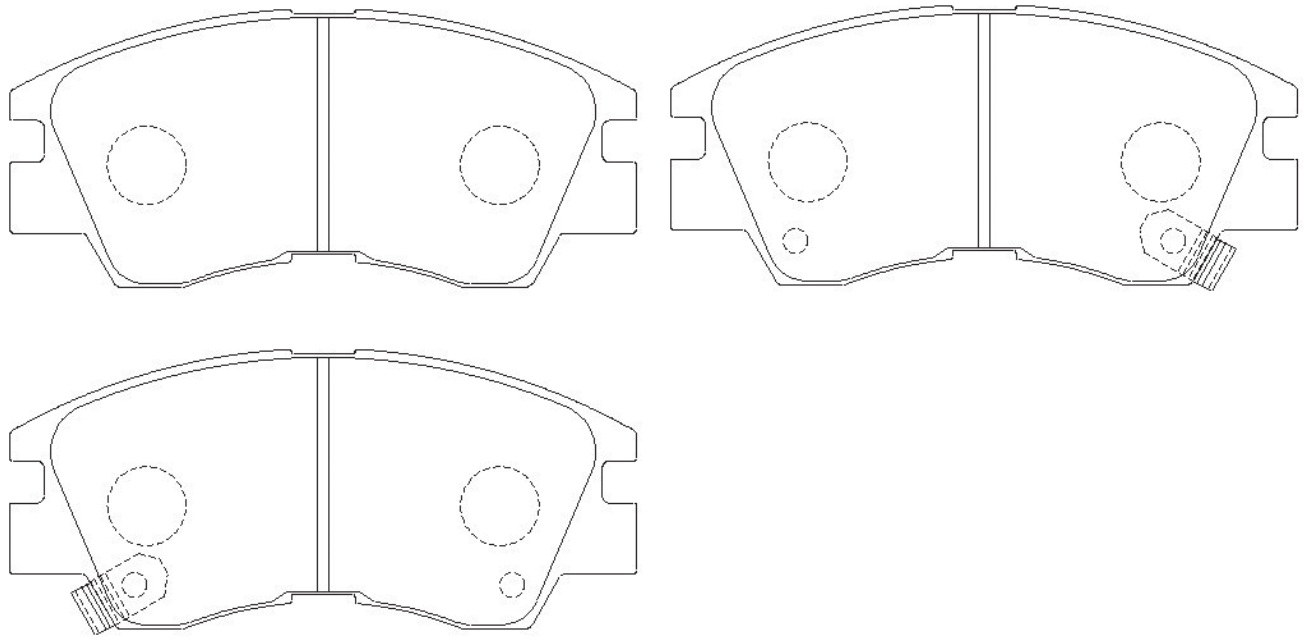

HN-173						127.7	51.5	16.7	AN-223WK
									D6021M-02

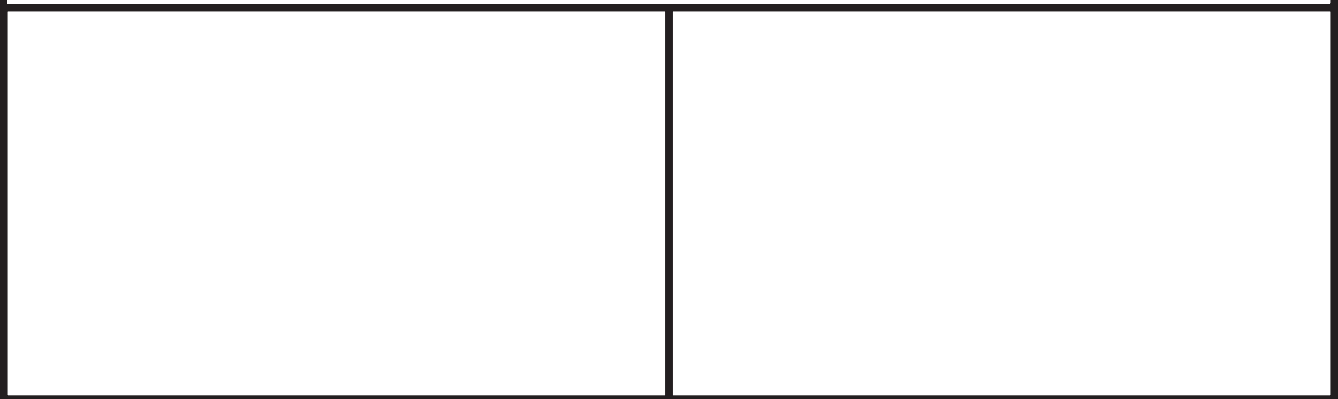
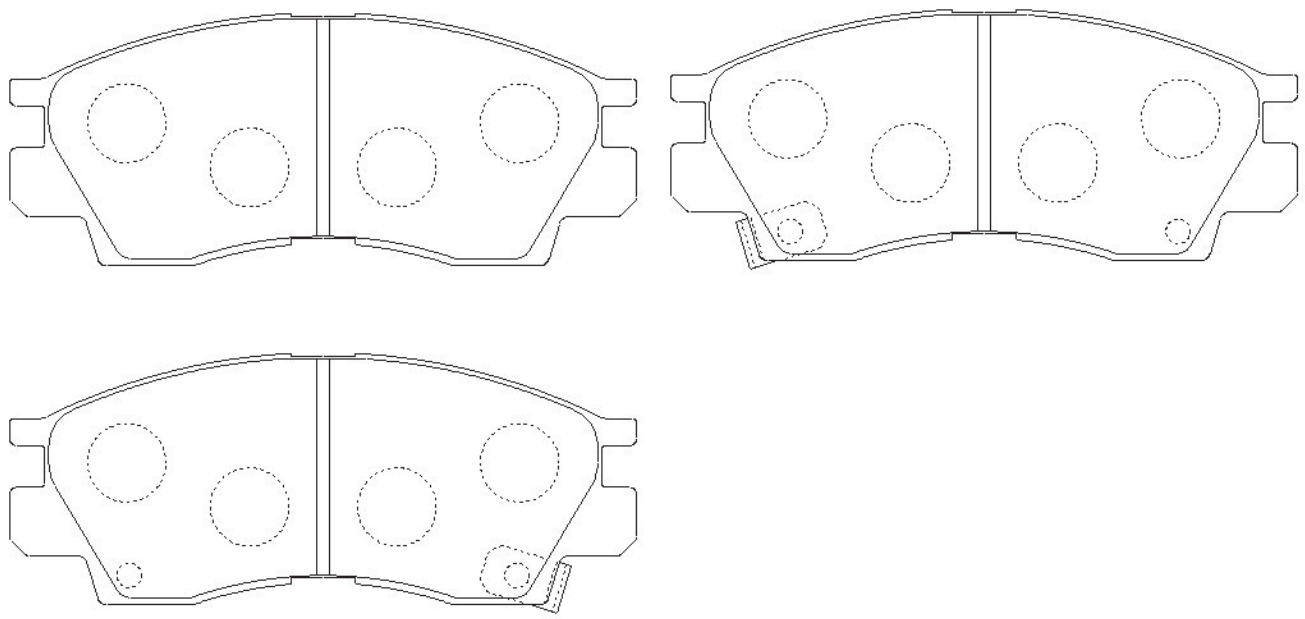

HN-No.	W	H	T	AKNo.	HN-No.	W	H	T	AKNo.
				MKNo.					MKNo.
HN-174						107.6	40.9	15.2	AN-224WK
									D6024M-02

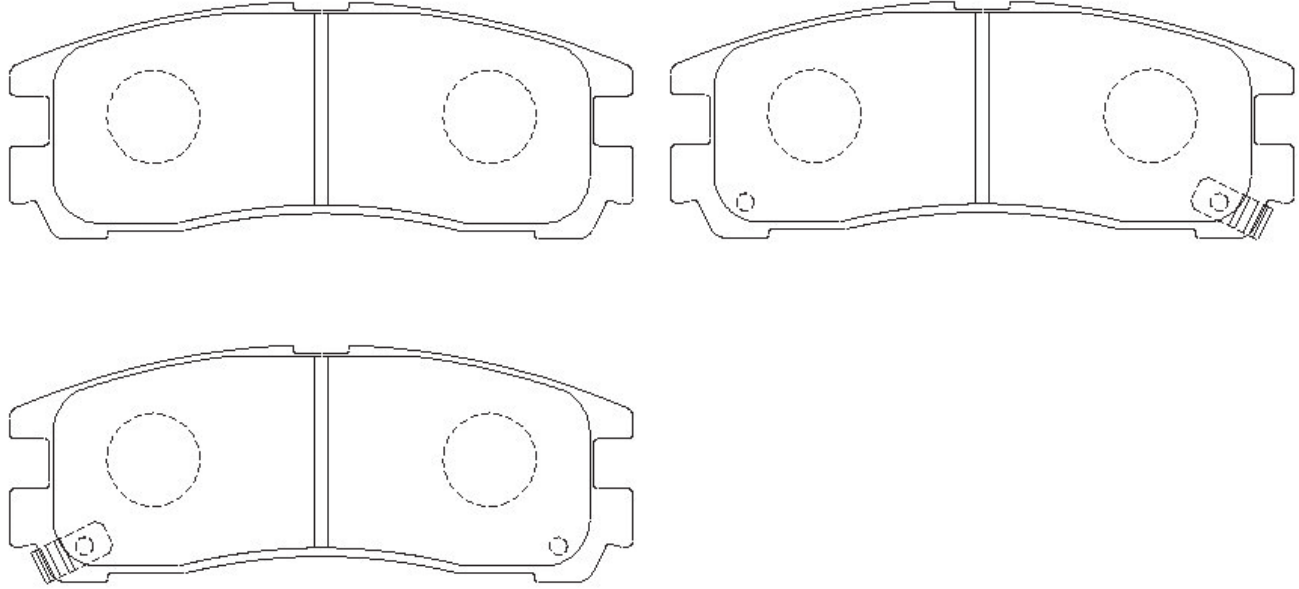

HN-175				133.1		53.0	17.2	AN-363WK
								D6030M-02

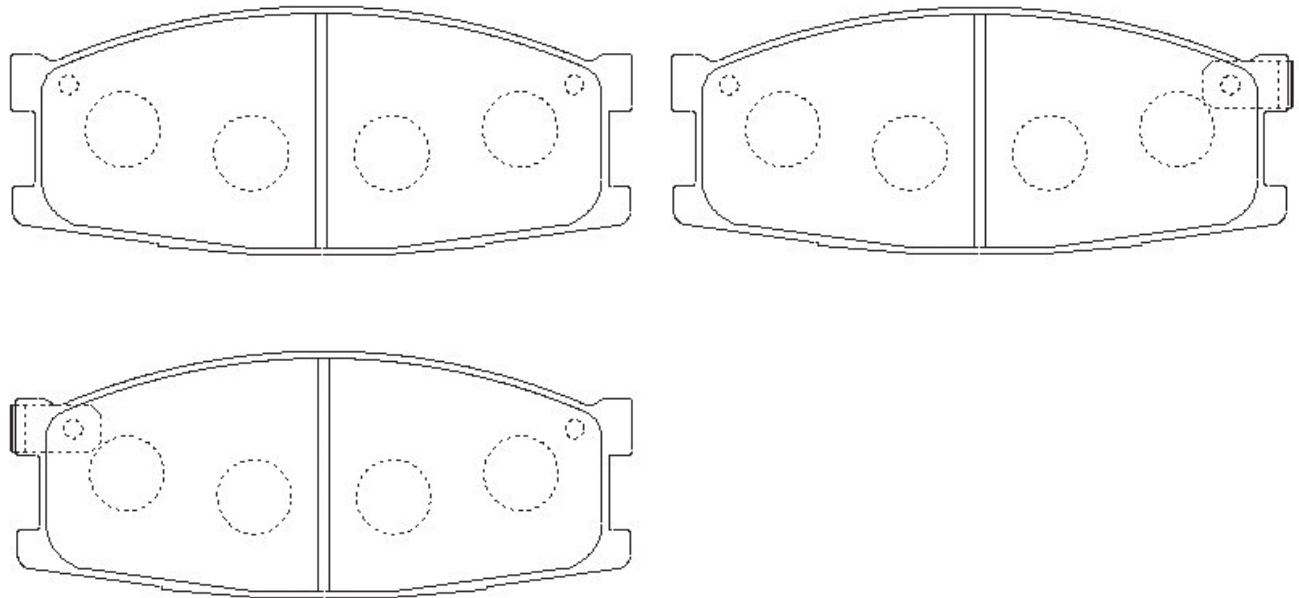

HN-No.	W	H	T	AKNo.	HN-No.	W	H	T	AKNo.
				MKNo.					MKNo.
HN-176						137.0	54.0	16.7	AN-262WK
									D1092M-02
HN-178	87.0	39.0	12.4	AN-254K	HN-181	103.0	39.2	13.7	AN-253K
				D2066-02					D7013-02
HN-182	102.0	37.0	13.7	AN-281K	HN-183	108.6	39.5	13.9	AN-282K
				D9014-02					D9013-02
HN-184						127.8	53.0	15.5	AN-268WK
									D2072M-02

HN-No.	W	H	T	AKNo.	HN-No.	W	H	T	AKNo.
				MKNo.					MKNo.
HN-185						128.7	35.5	13.3	AN-255K
									D0006-02

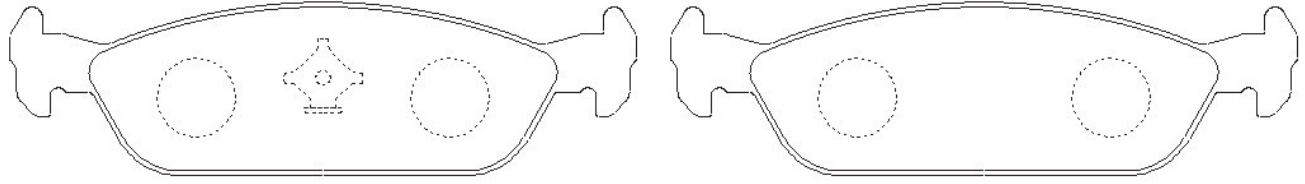

HN-186				108.0		47.0		13.9	AN-342K
				102.8		47.0		13.9	D0011-02

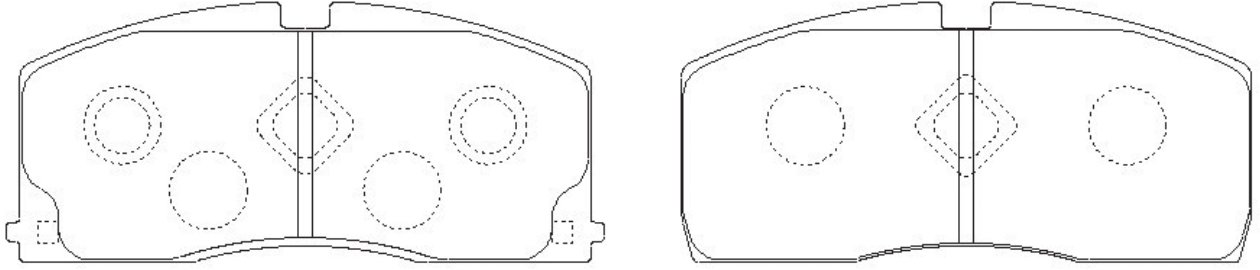

HN-187				108.0		42.0		14.9	AN-341K
				102.8		42.0		14.9	D0019-02

※discontinued

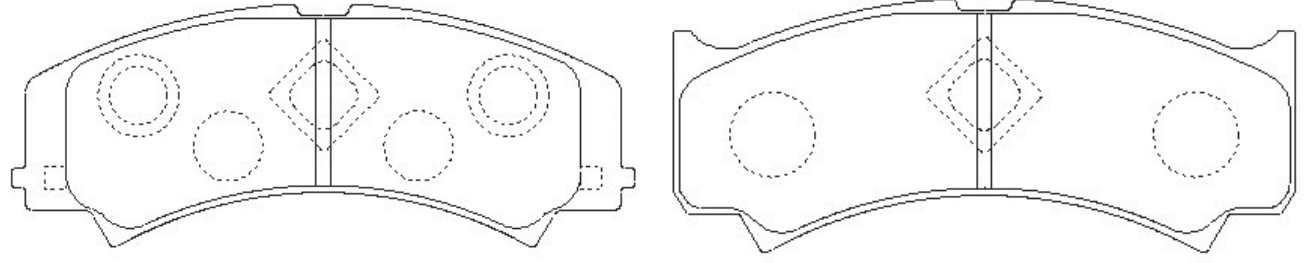

HN-188				127.8		50.0		15.8	AN-252WK
									D1084M-02

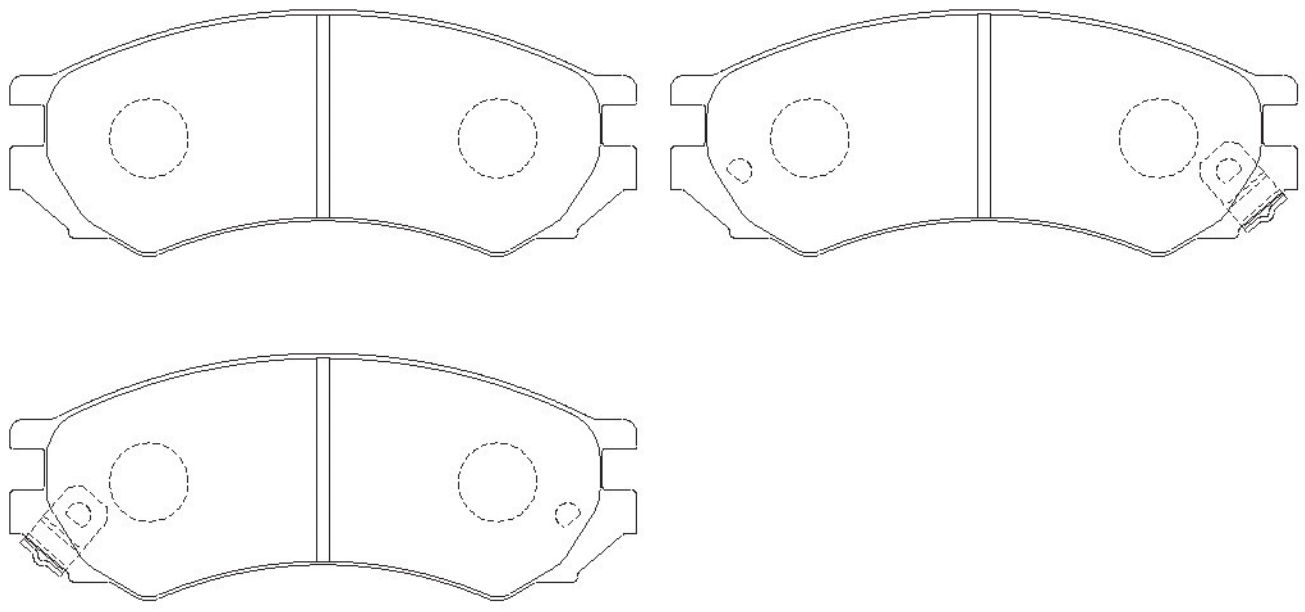

HN-No.	W	H	T	AKNo.	HN-No.	W	H	T	AKNo.
				MKNo.					MKNo.
HN-190						127.6	48.0	14.8	AN-459WK
									D5037M-02

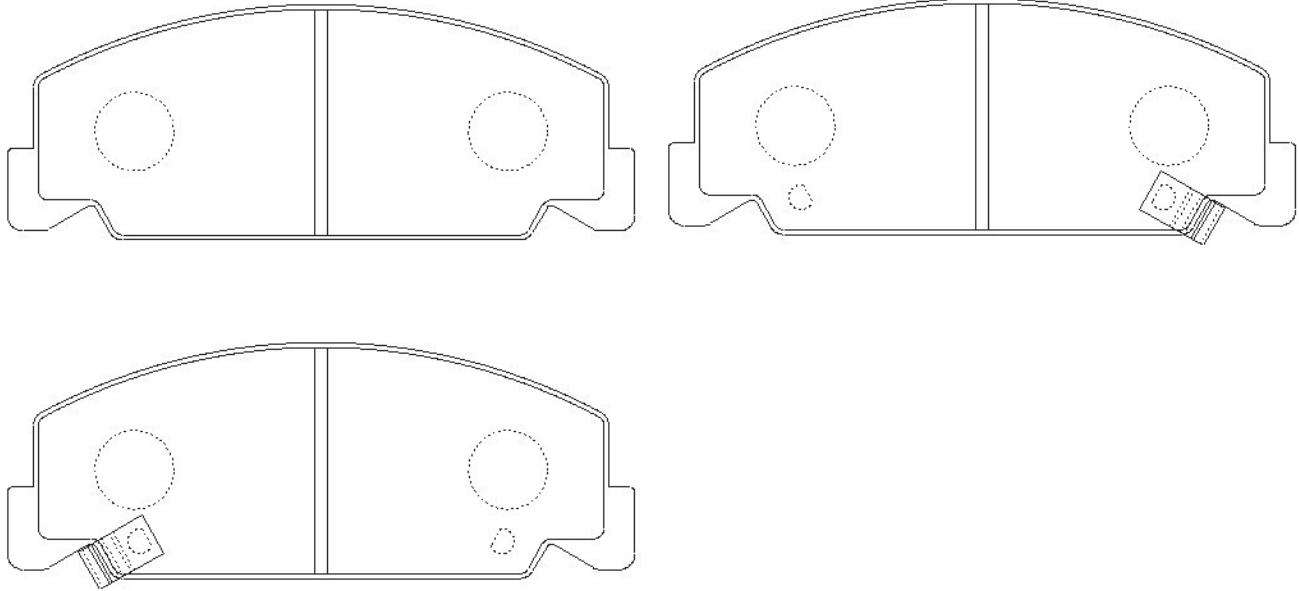

HN-191						132.0	49.5	14.8	AN-264WK
									D5039M-02

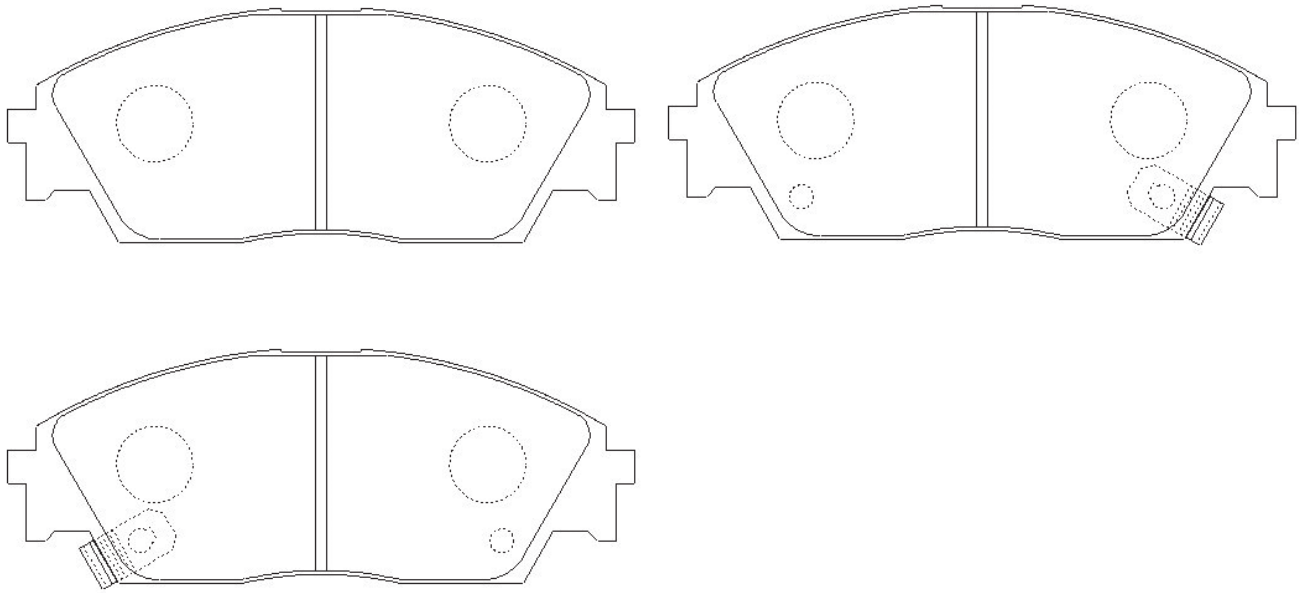

HN-192	127.8	51.1	17.8	A-SM246K	

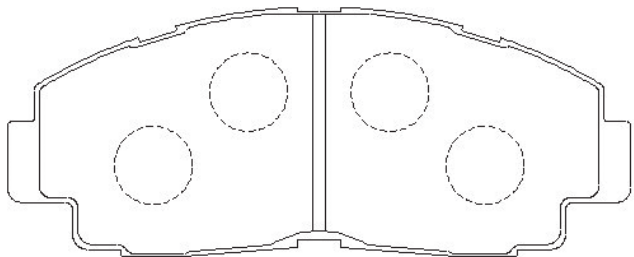

HN-No.	W	H	T	AKNo.	HN-No.	W	H	T	AKNo.
				MKNo.					MKNo.
HN-194						129.8	52.5	15.8	AN-249WK
									D3053M-02

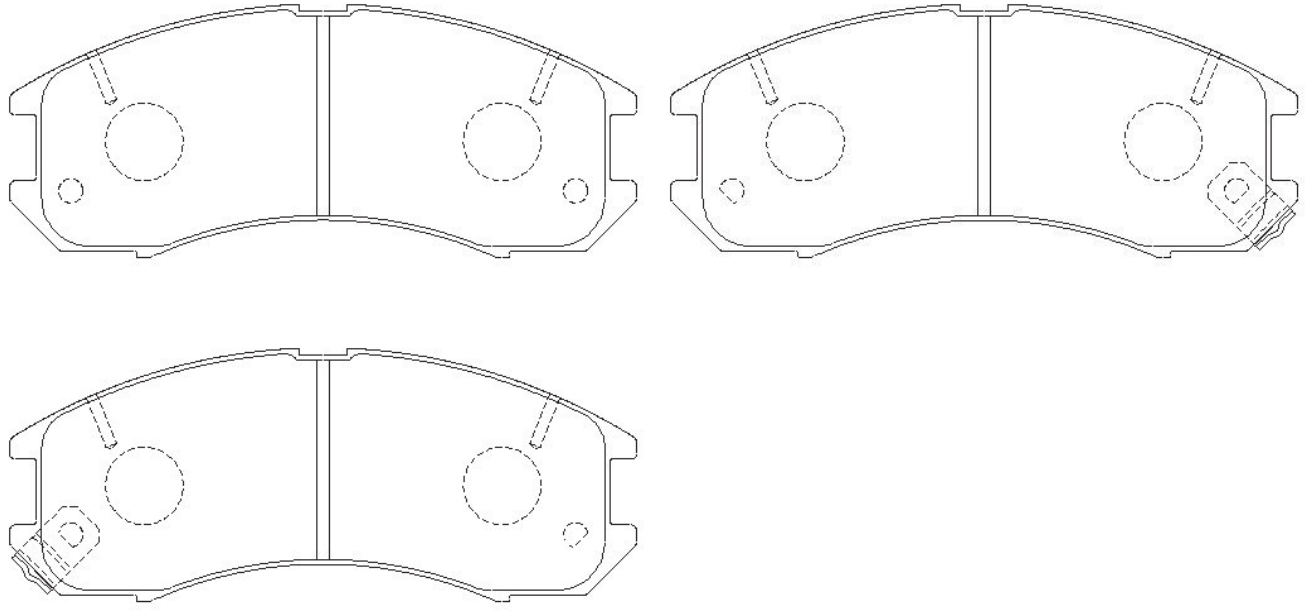

HN-195	104.0	42.2	12.8	AN-250K
				D3056-02

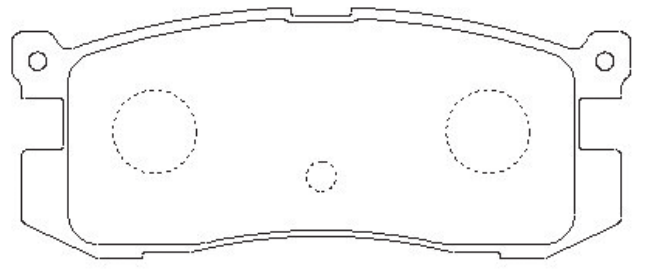

HN-196					127.0	51.0	16.3	AN-248WK
								D4029M-02

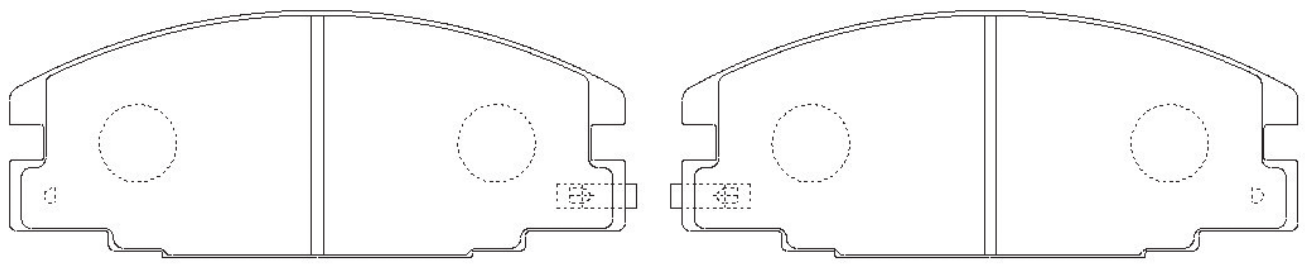

HN-No.	W	H	T	AKNo.	HN-No.	W	H	T	AKNo.
				MKNo.					MKNo.
HN-197						131.3	44.0	13.1	AN-270WK
									D4021M-02

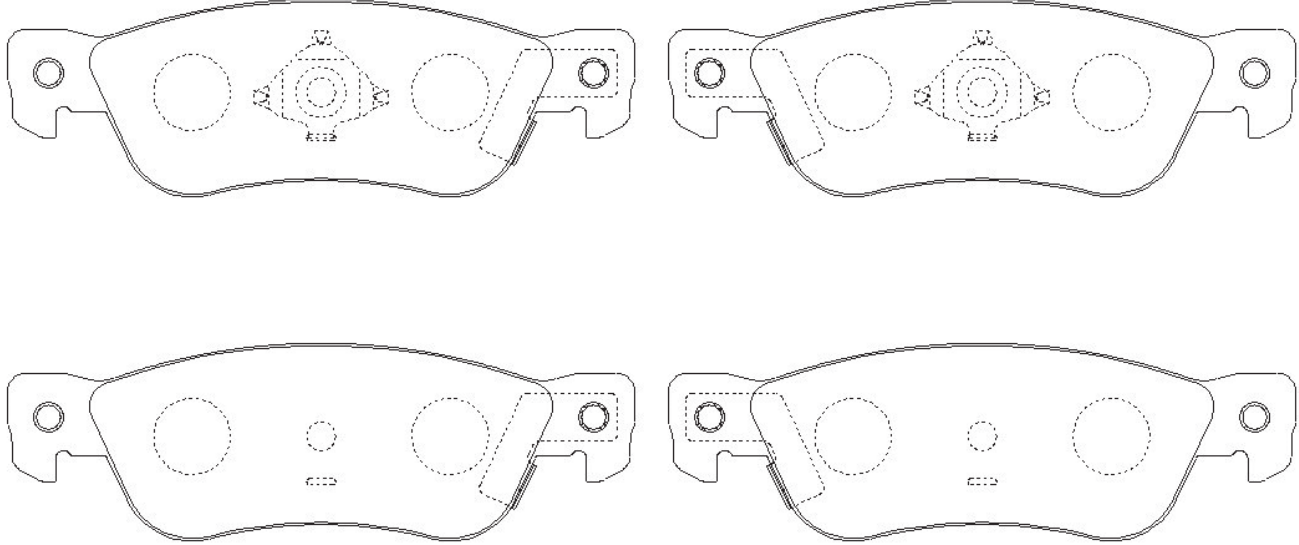

HN-198	102.0	39.0	12.5	AN-307K
				D0021-02

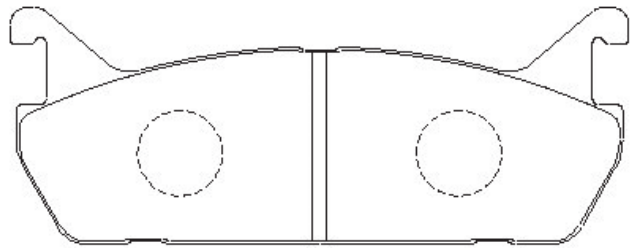

HN-199				121.0	50.6	15.8	AN-277WK
							D1116M-02

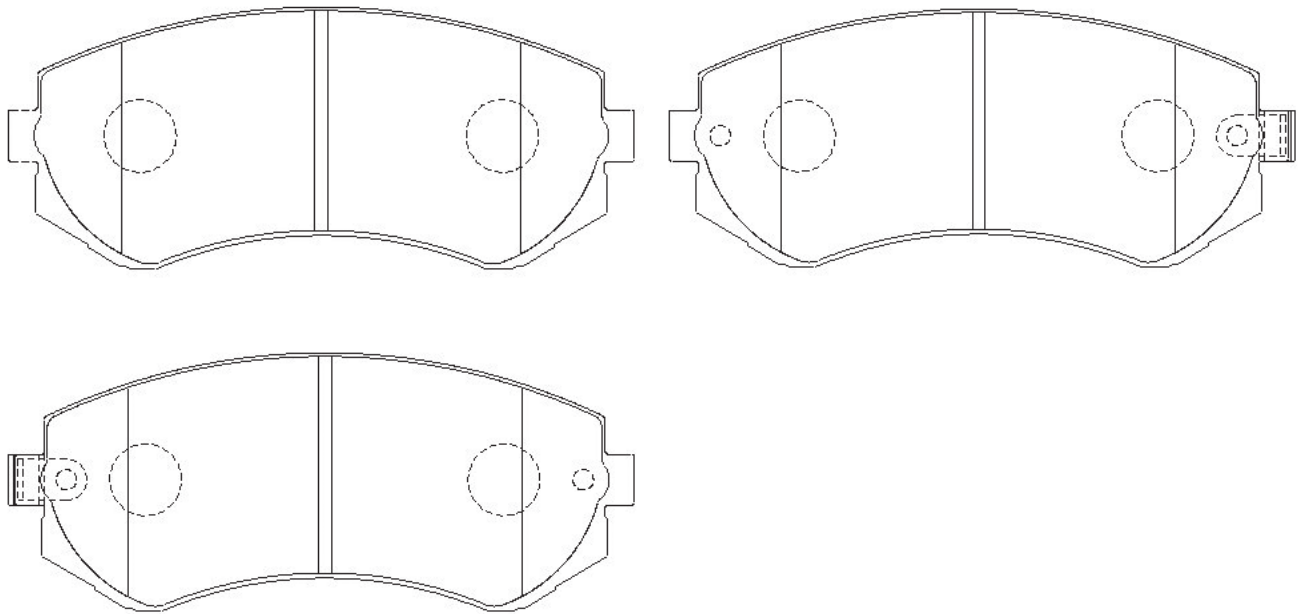

HN-No.	W	H	T	AKNo.	HN-No.	W	H	T	AKNo.
				MKNo.					MKNo.
HN-200						98.8	34.7	14.9	AN-149WK
									D1047M-02

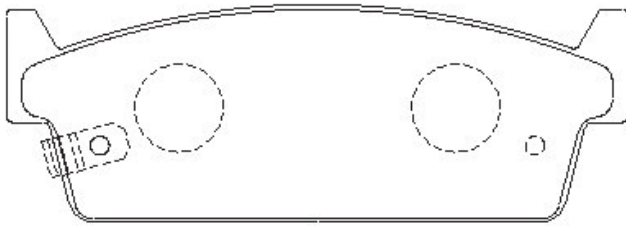
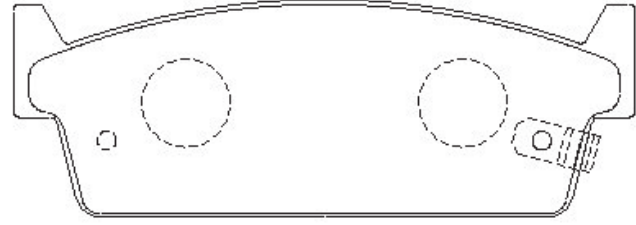
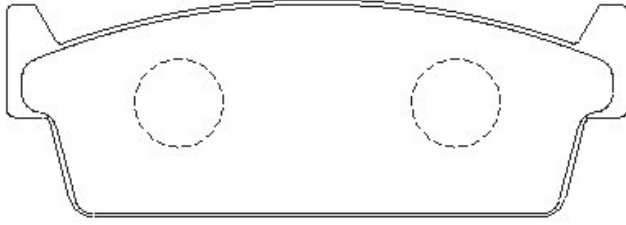

HN-201A						137.0	53.0	16.8	AN-286WK
									D1110M-02

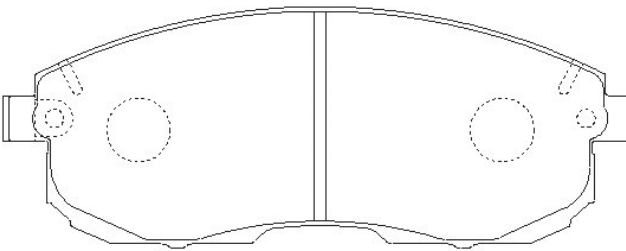
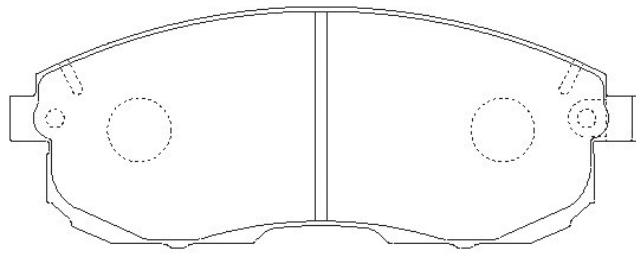
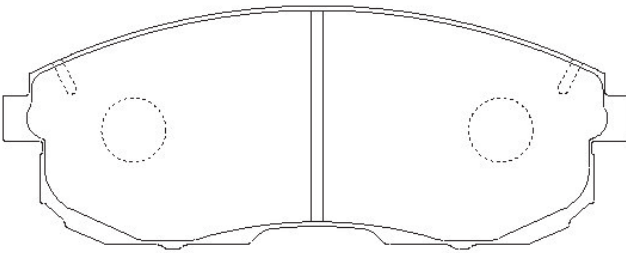

HN-203	107.8	39.5	12.9	AN-219K	HN-204	142.0	54.5	17.8	AN-288K
				D3027-02					D1121-02

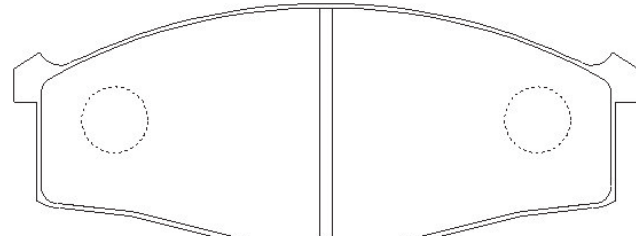
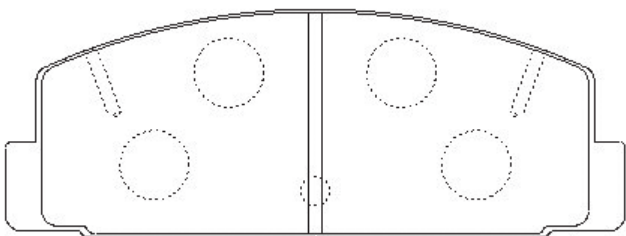

HN-No.	W	H	T	AKNo.	HN-No.	W	H	T	AKNo.
				MKNo.					MKNo.
HN-205						85.4	38.5	12.8	AN-285WK
									D5016M-02

※discontinued

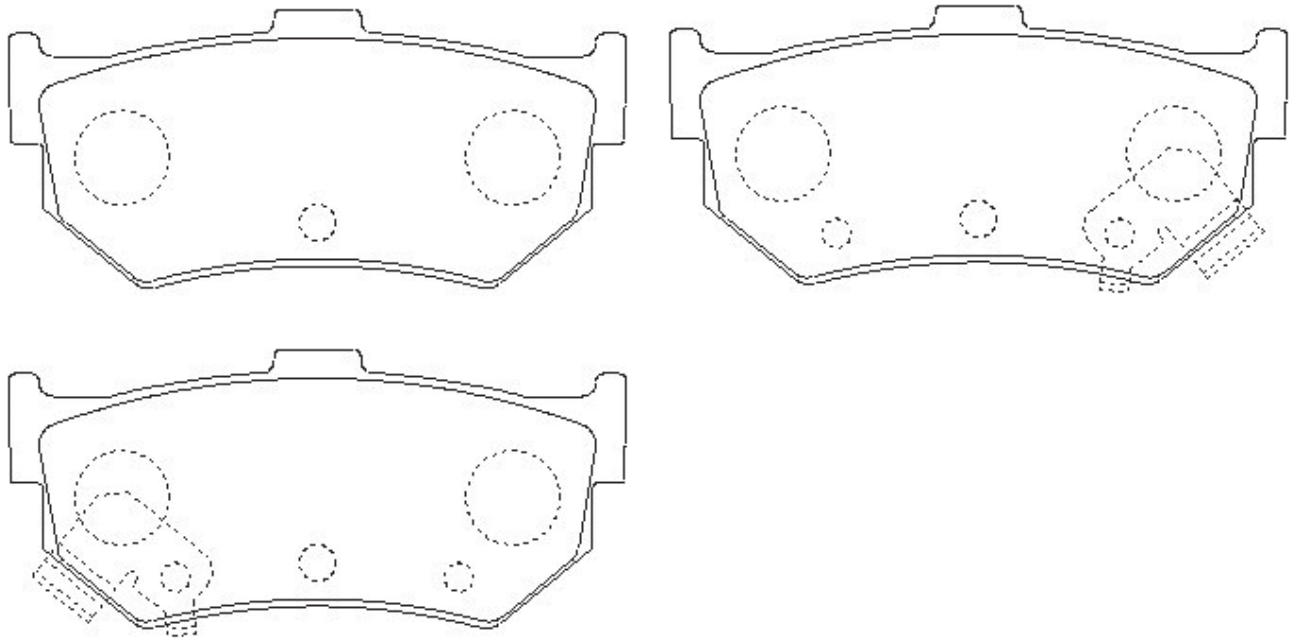

HN-206						89.0	35.0	12.8	AN-265WK
									D5042M-02

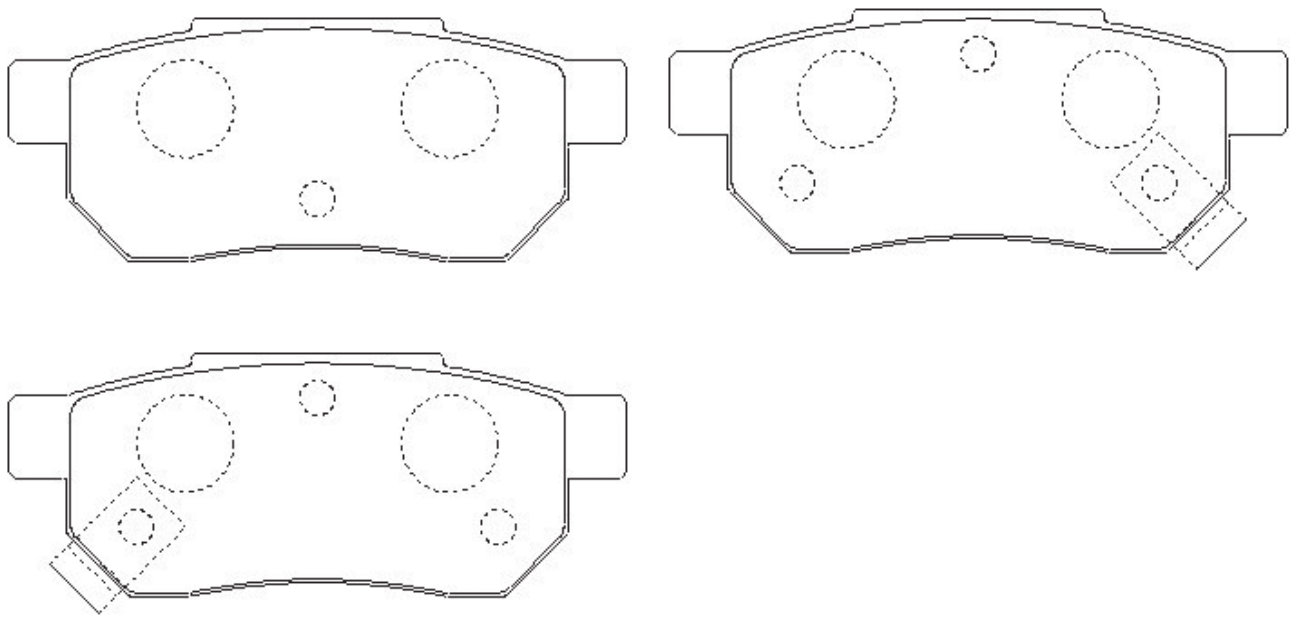

HN-No.	W	H	T	AKNo.	HN-No.	W	H	T	AKNo.
				MKNo.					MKNo.
HN-207						85.3	38.0	14.8	AN-204WK
									D7009M-02

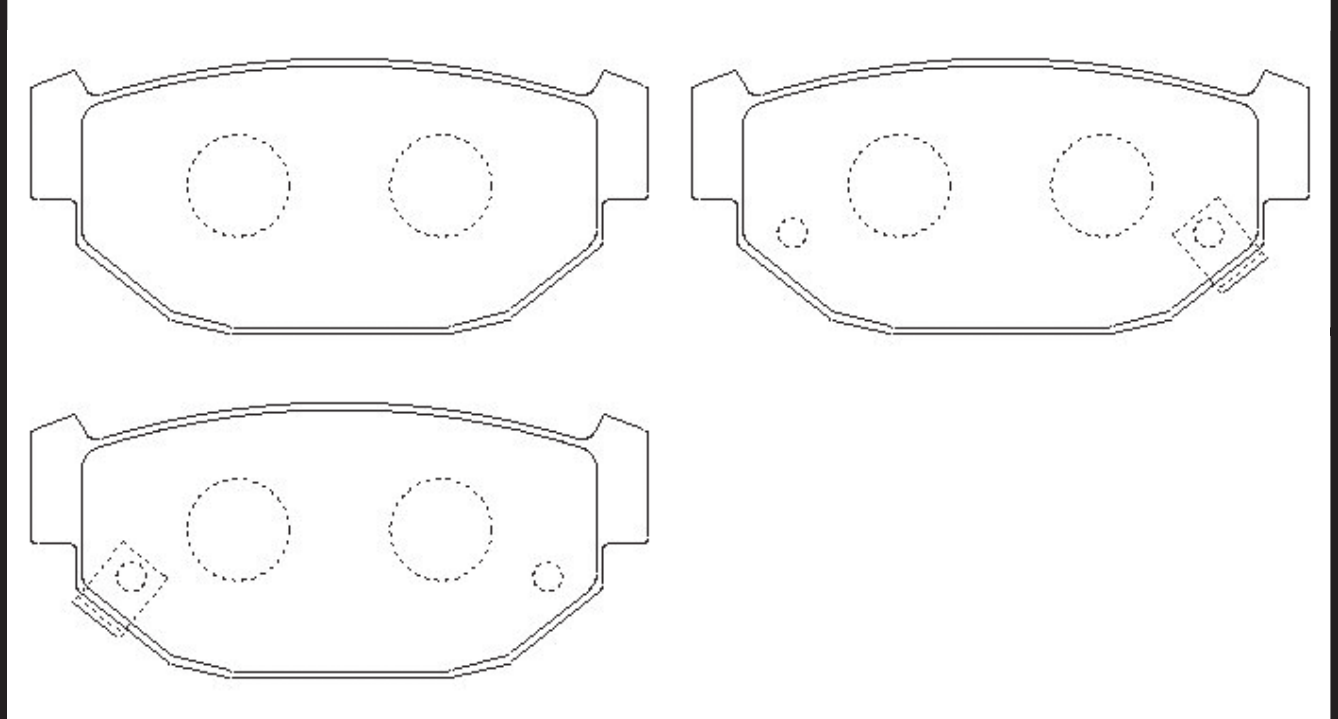

HN-208	109.3	44.1	14.0	AN-284K	HN-209	140.1	55.5	15.3	AN-267K
				D9015-02					

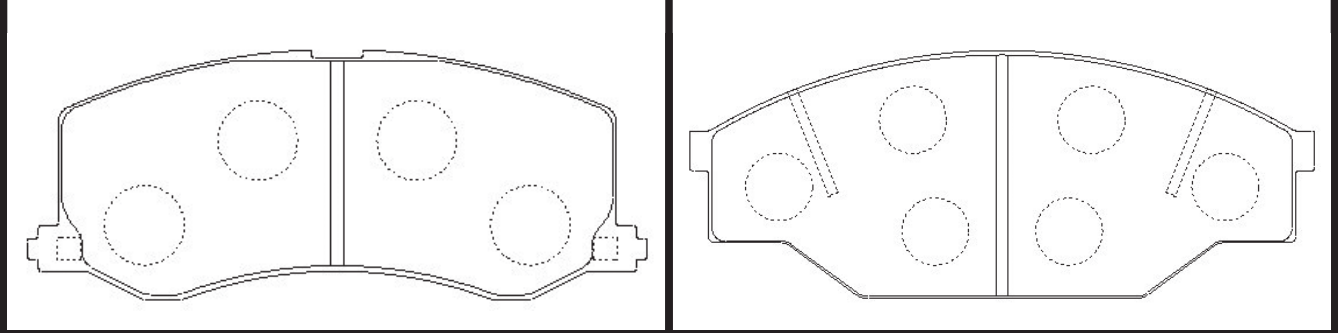

HN-211						133.0	52.0	15.0	AN-133WK
									D3047M-02

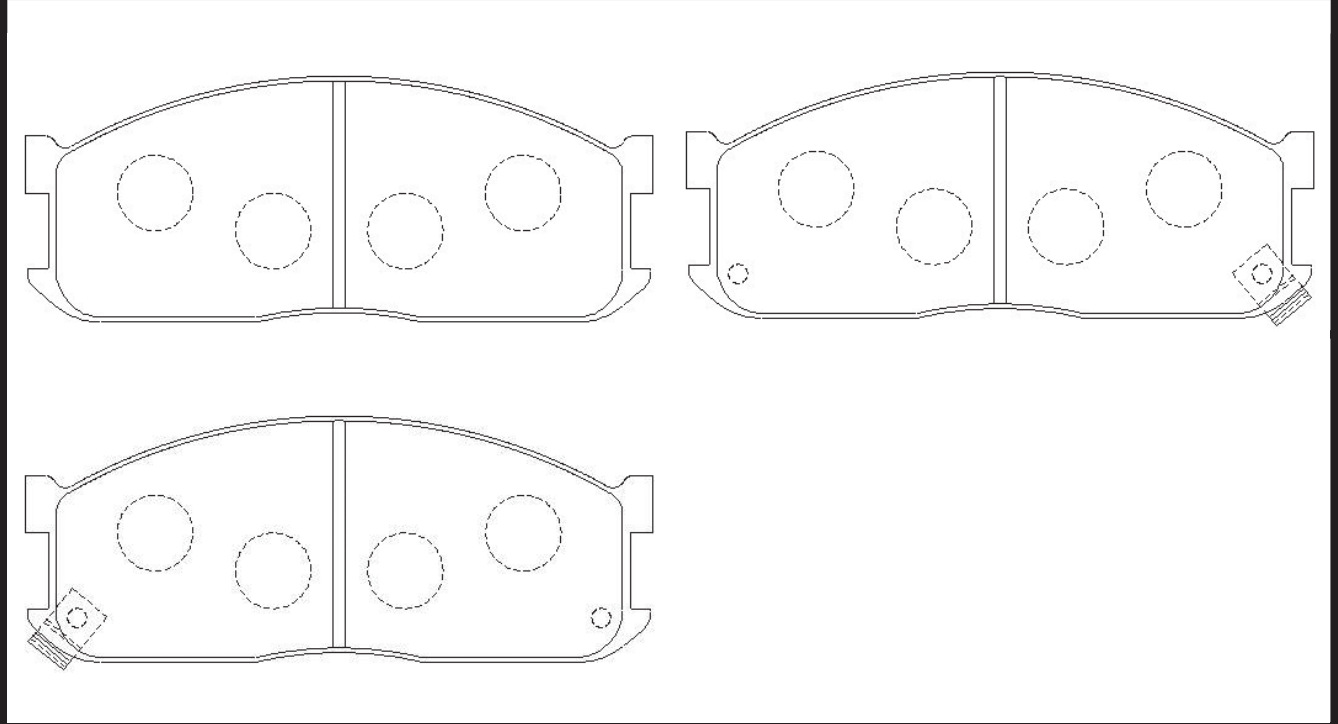

HN-No.	W	H	T	AKNo.	HN-No.	W	H	T	AKNo.
				MKNo.					MKNo.
HN-212	144.3	53.0	15.6	AN-217K	HN-213	105.0	53.5	14.4	AN-283K
				D2059-02					

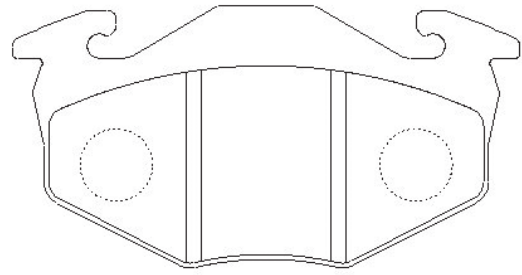
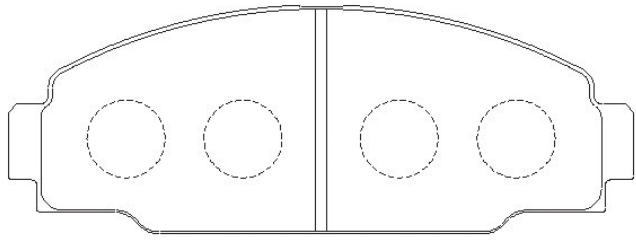

HN-214					102.7	47.2	13.8	AN-243WK
								D0008M-02

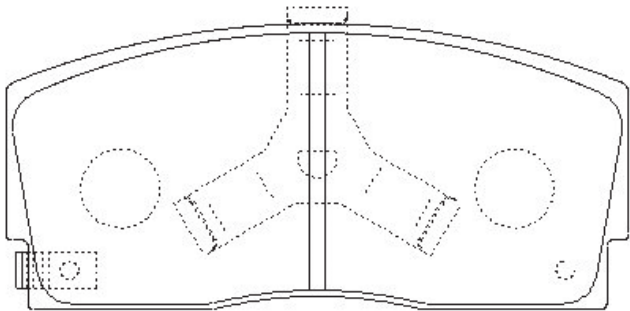
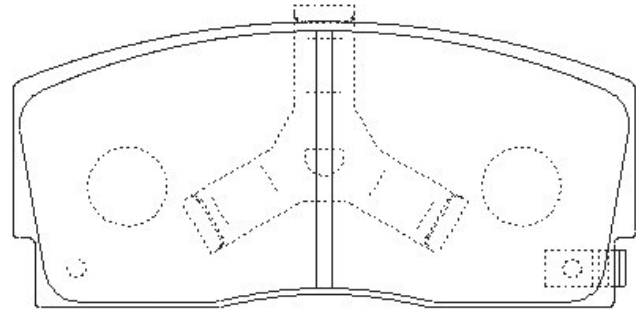
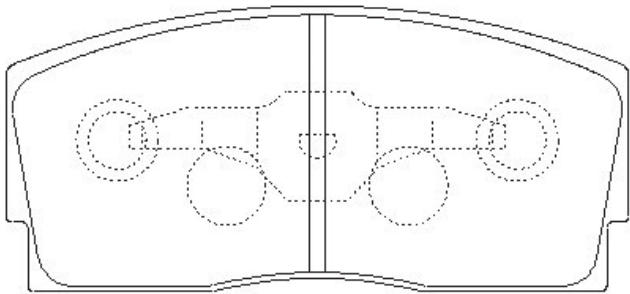

HN-216					128.3	52.0	15.2	AN-294WK
					126.7	55.0	15.2	D2050M-02

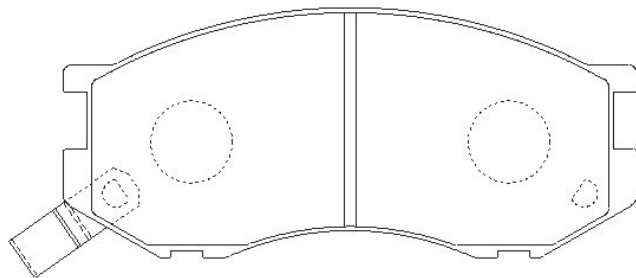
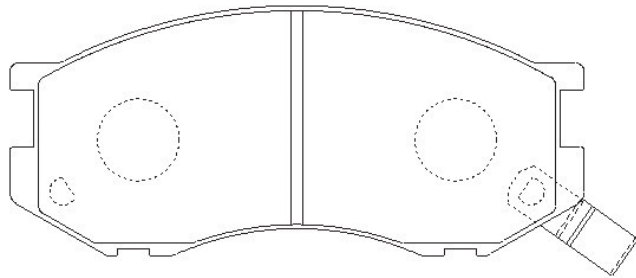
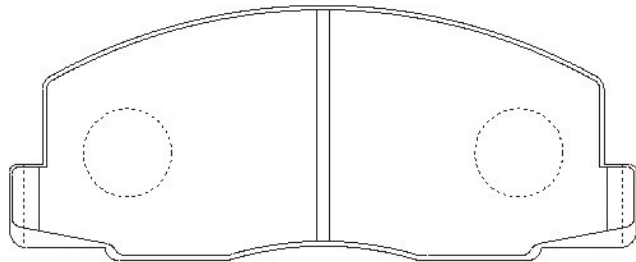

HN-No.	W	H	T	AKNo.	HN-No.	W	H	T	AKNo.
				MKNo.					MKNo.
HN-217				128.2					AN-238WK
				126.8					55.0

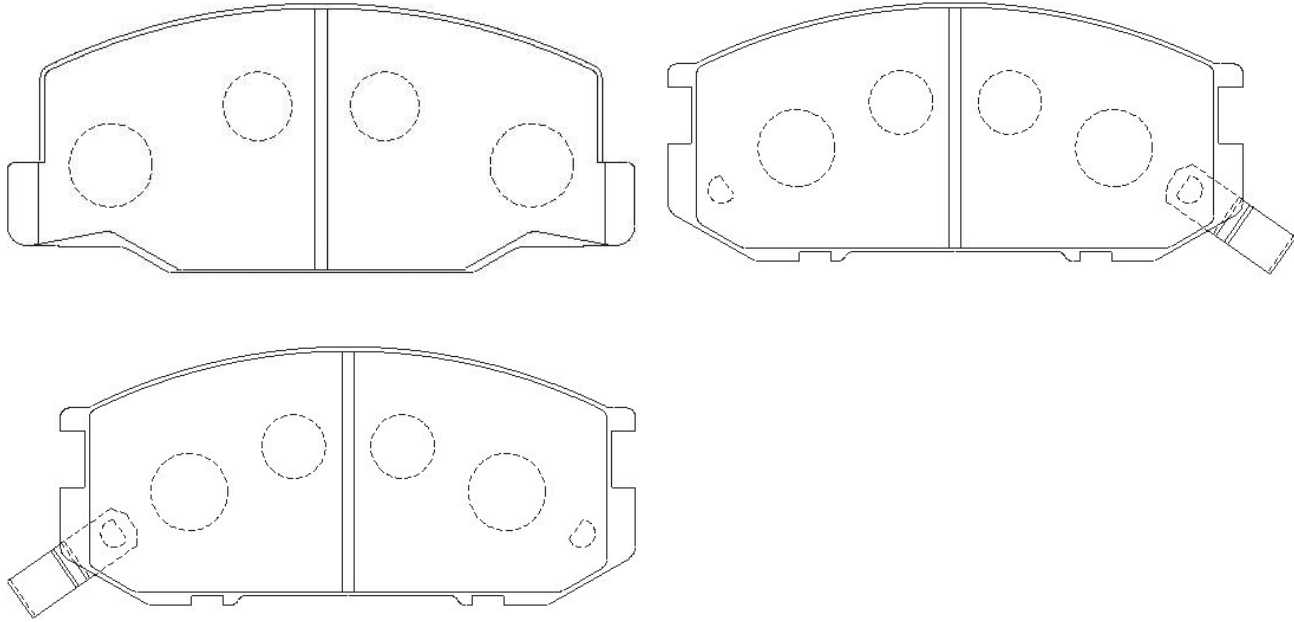

HN-218				128.3					AN-293WK
				136.7					52.0

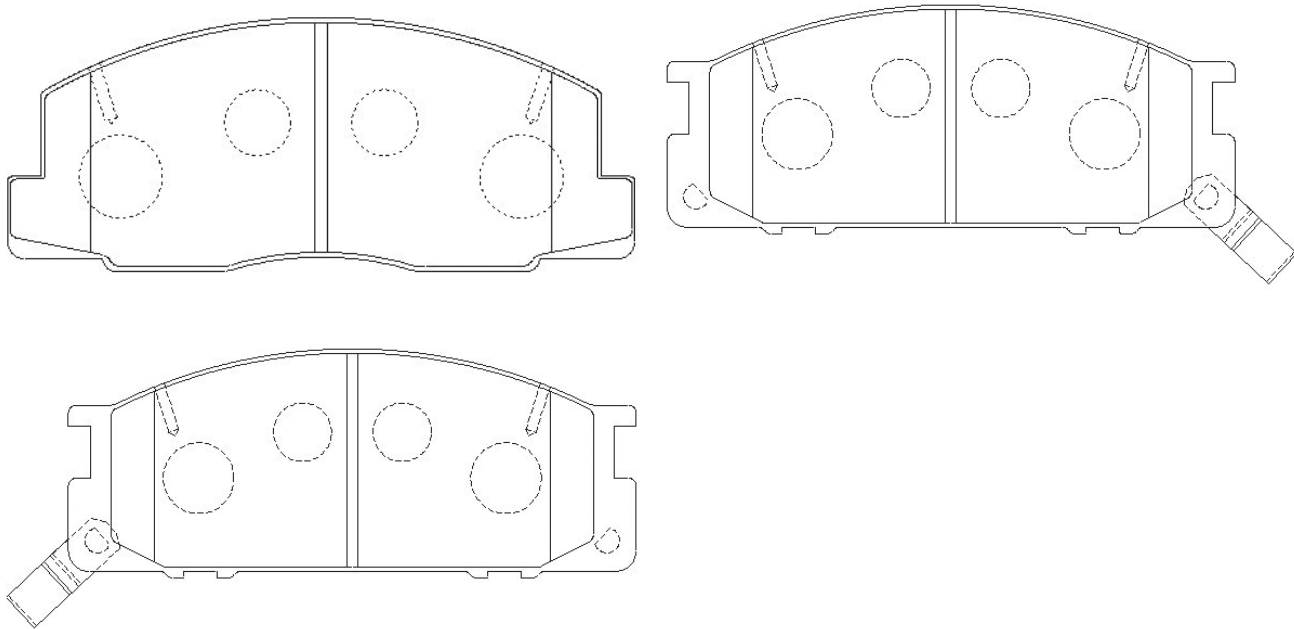

HN-No.	W	H	T	AKNo.	HN-No.	W	H	T	AKNo.
				MKNo.					MKNo.
HN-219				119.2					AN-303WK
				119.2					72.4

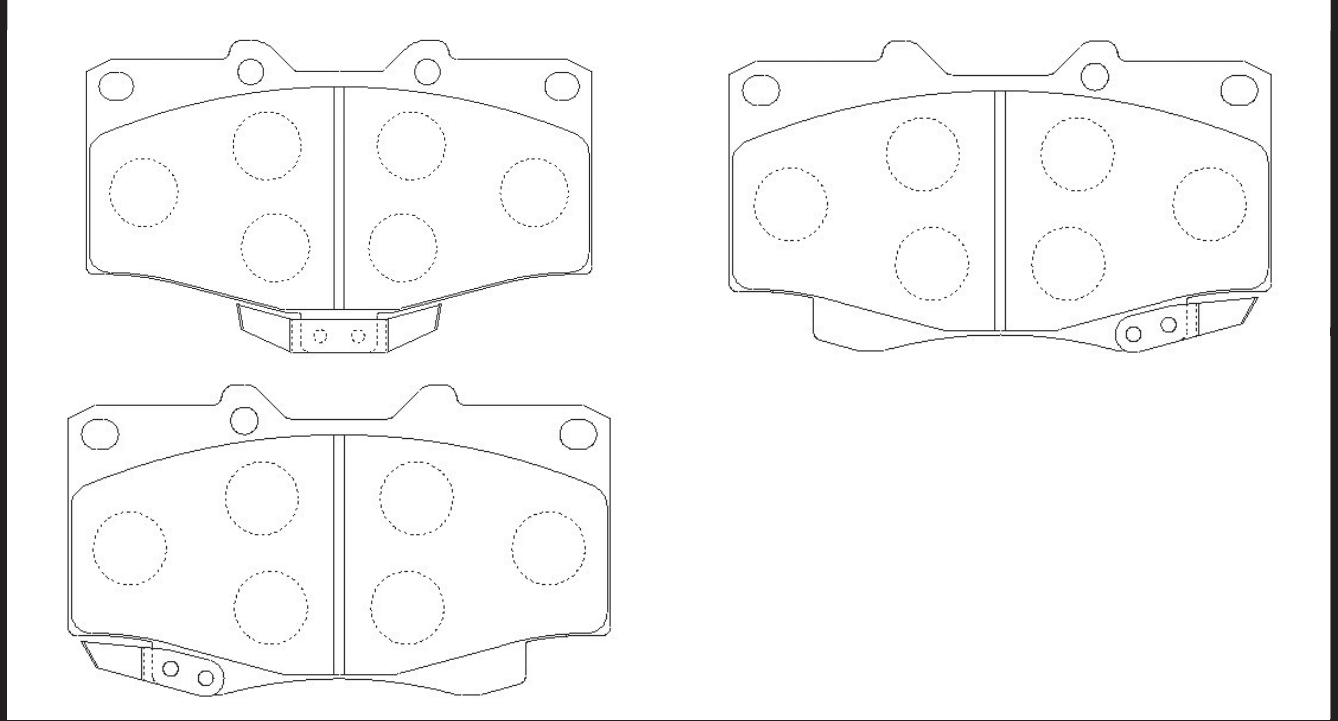

HN-220				119.2					AN-301WK
				119.2					52.9

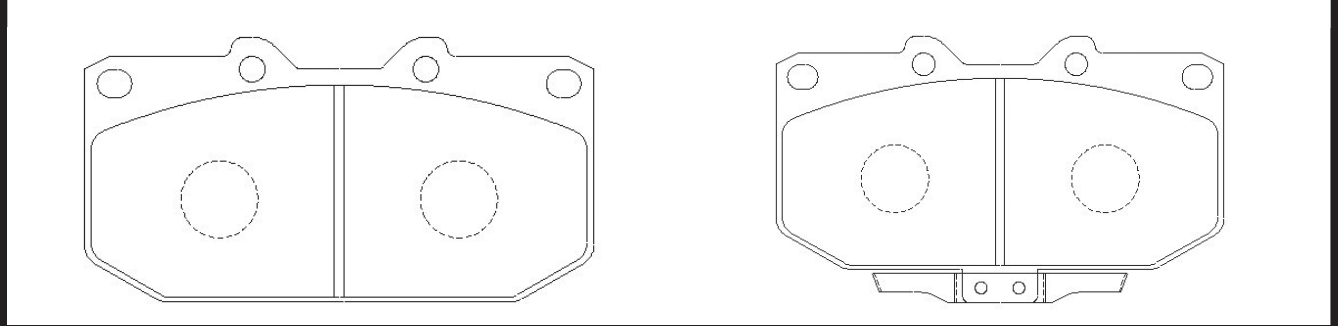

HN-221				73.2					AN-302WK
									54.5

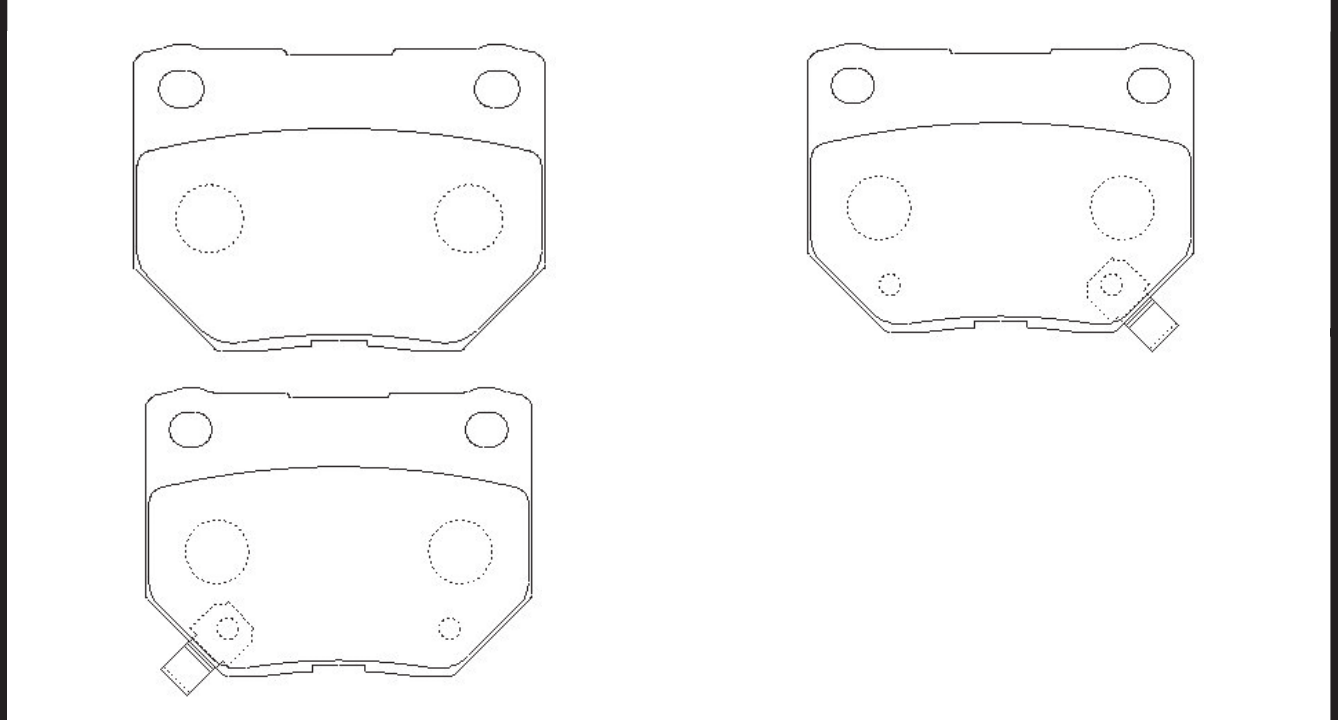

HN-No.	W	H	T	AKNo.	HN-No.	W	H	T	AKNo.
				MKNo.					MKNo.
HN-222						140.1	51.5	17.8	AN-300WK
									D6027M-02

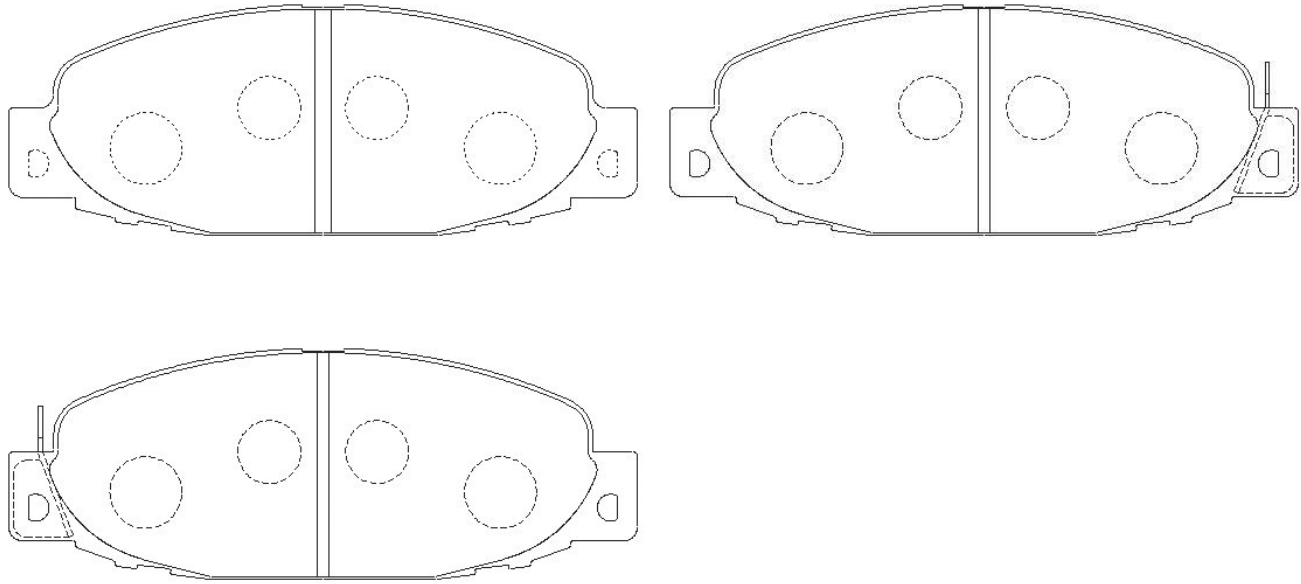

HN-223						141.0	55.5	18.3	AN-308WK
									D5053M-02

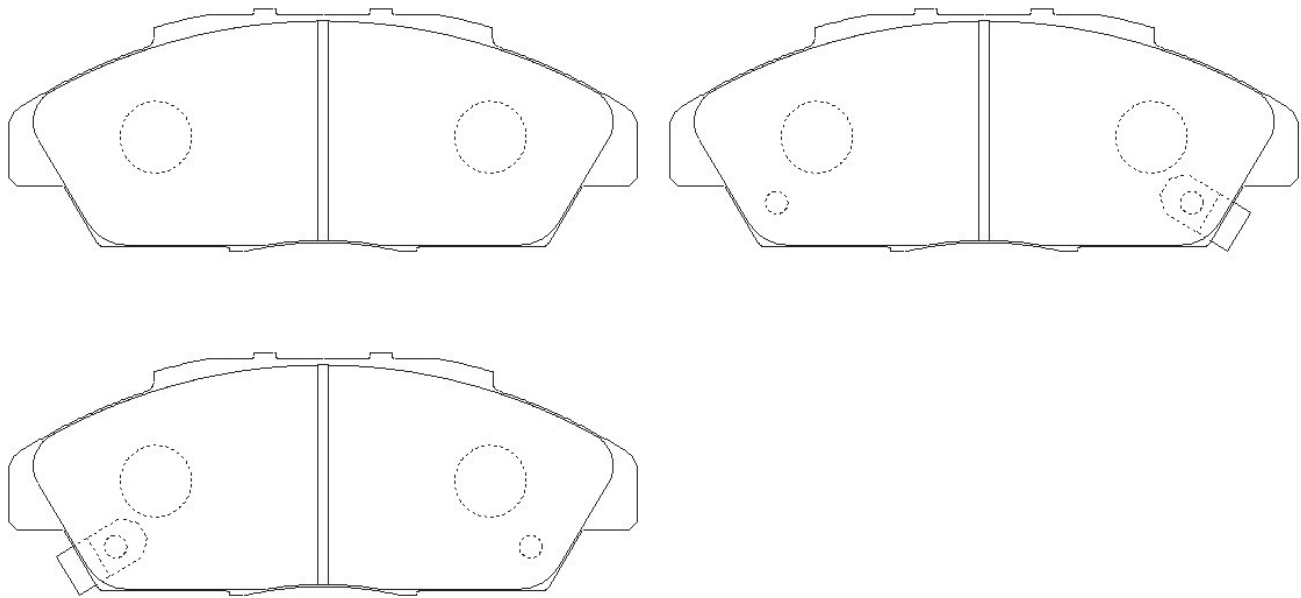

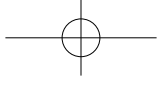

HN-No.	W	H	T	AKNo.	HN-No.	W	H	T	AKNo.
				MKNo.					MKNo.

HN-224						105.3	47.0	16.3	AN-346WK
									D1148M-02

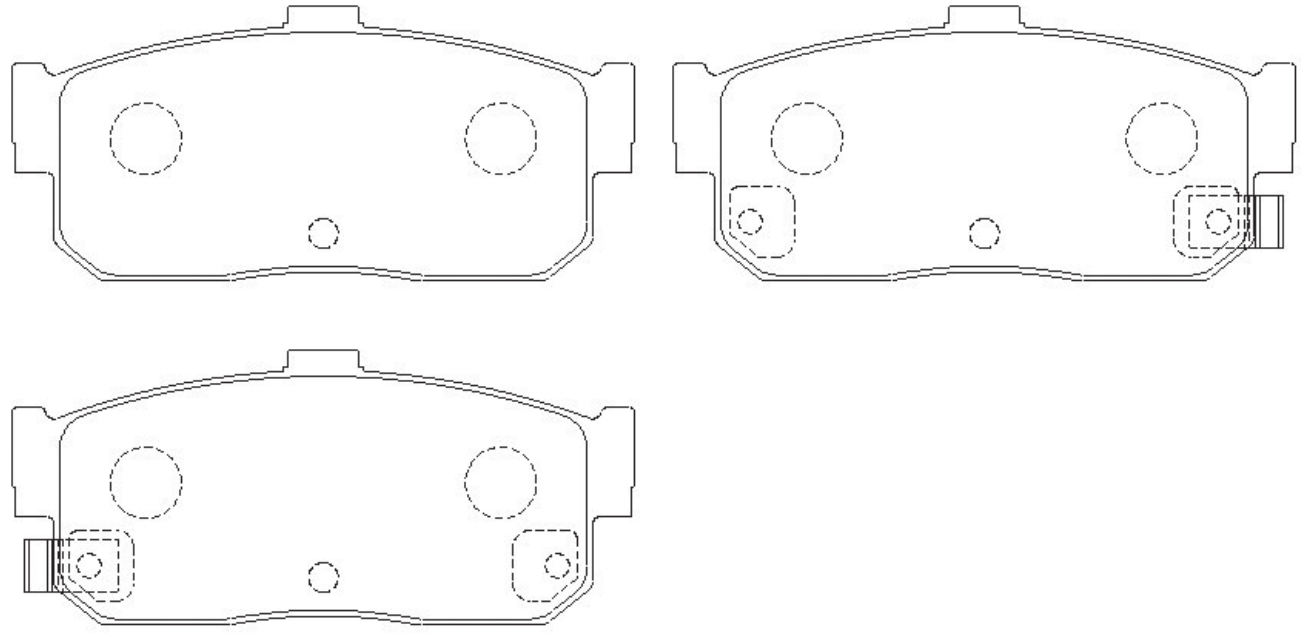

HN-225				114.8		51.1	15.8	AN-325WK
								D1136M-02

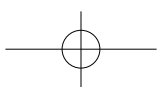
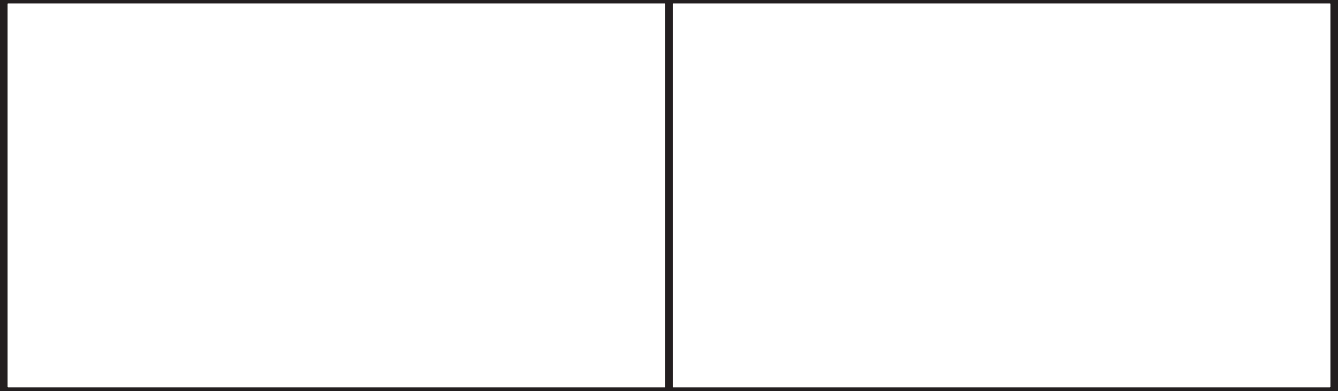
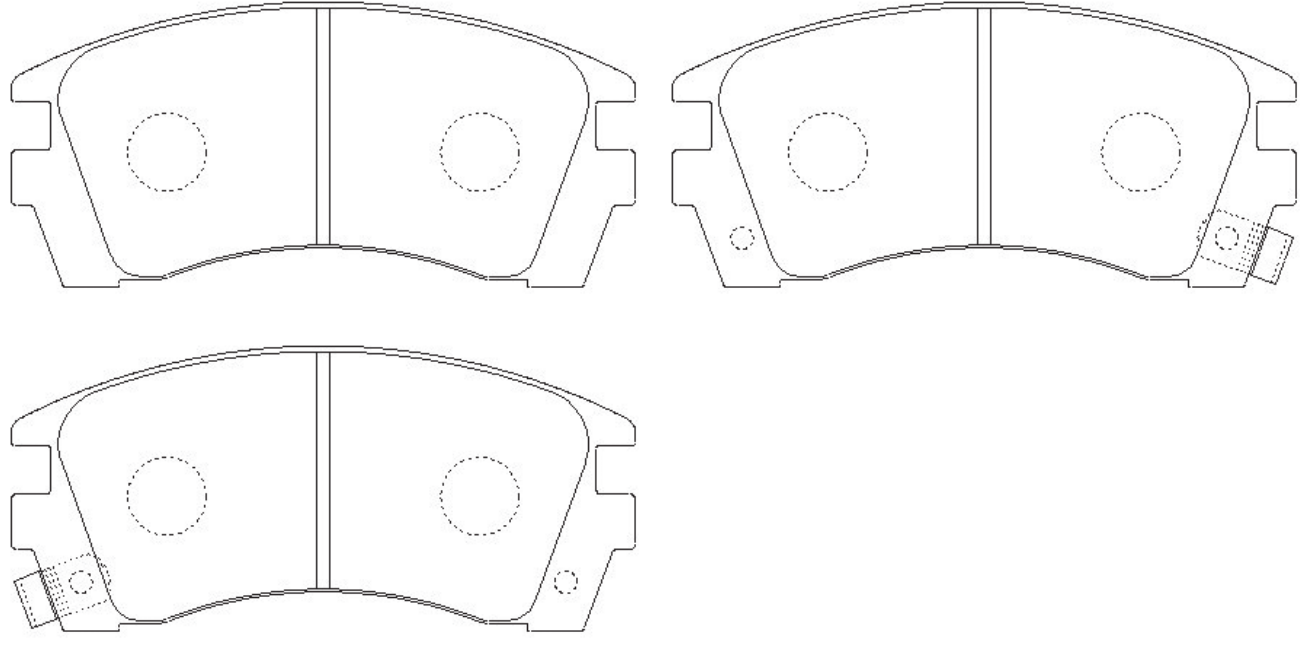

HN-No.	W	H	T	AKNo.	HN-No.	W	H	T	AKNo.
				MKNo.					MKNo.
HN-226						108.5	48.0	16.3	AN-327WK
									D1133M-02

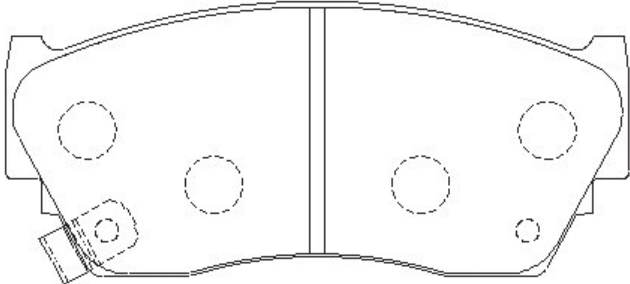
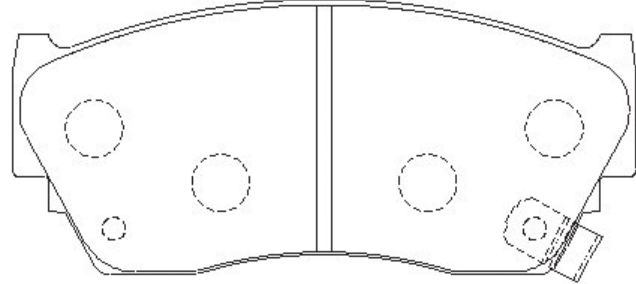
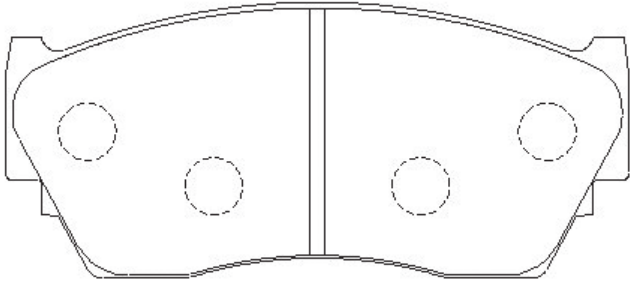

HN-227	140.1	55.0	15.5	AN-333K	HN-228	141.0	62.5	16.9	AN-322K
				D2086-02					

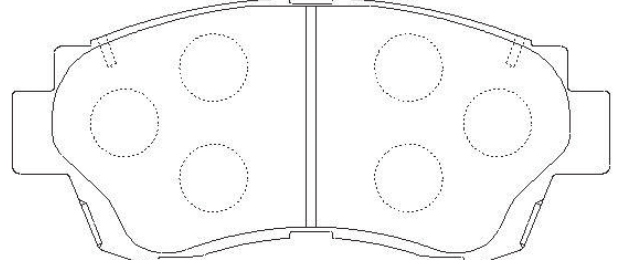
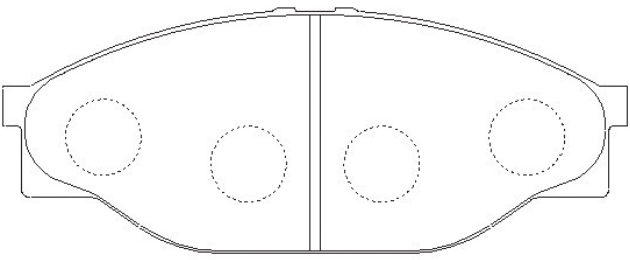

HN-229	144.3	57.0	15.6	AN-269K					
				D2081-02					

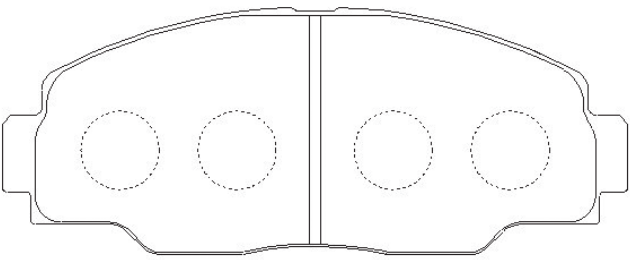

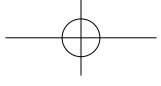

HN-No.	W	H	T	AKNo.	HN-No.	W	H	T	AKNo.
				MKNo.					MKNo.

HN-230						91.7	71.0	14.8	AN-338WK
									D3066M-02

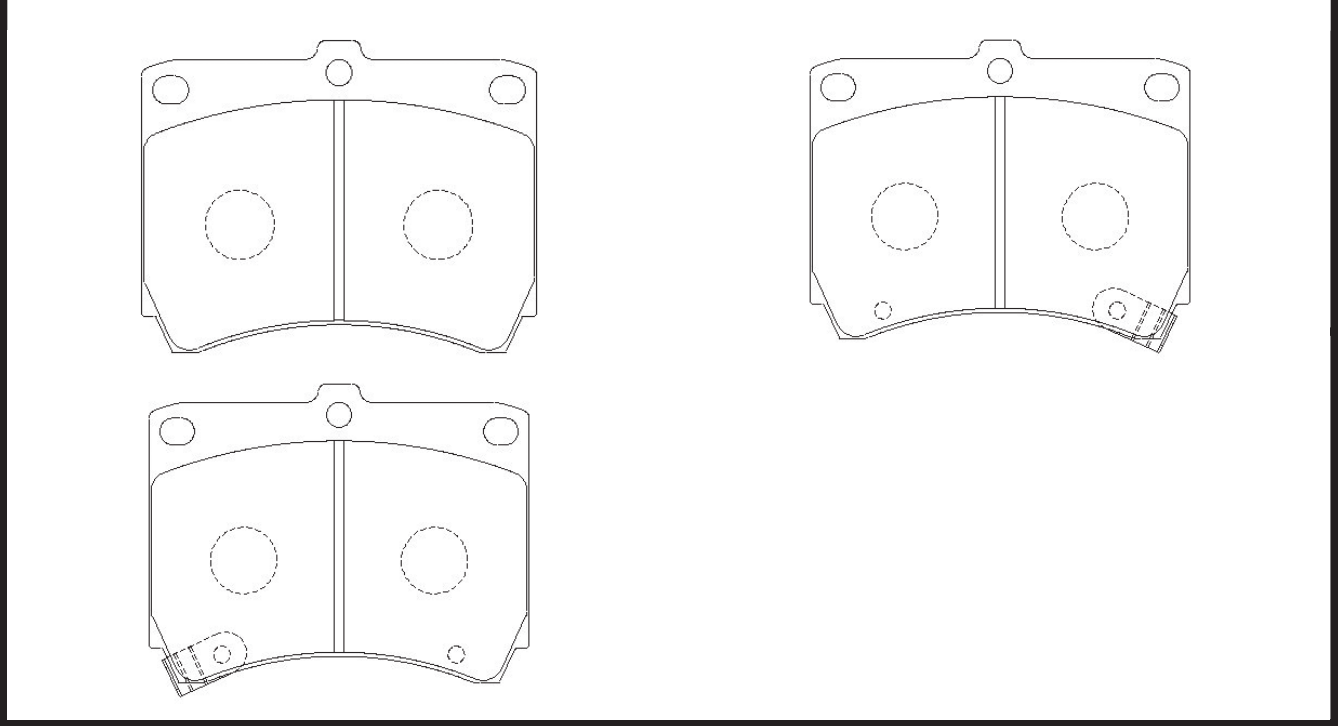

HN-232						91.7	64.0	14.8	AN-298WK
									D3062M-02

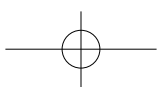
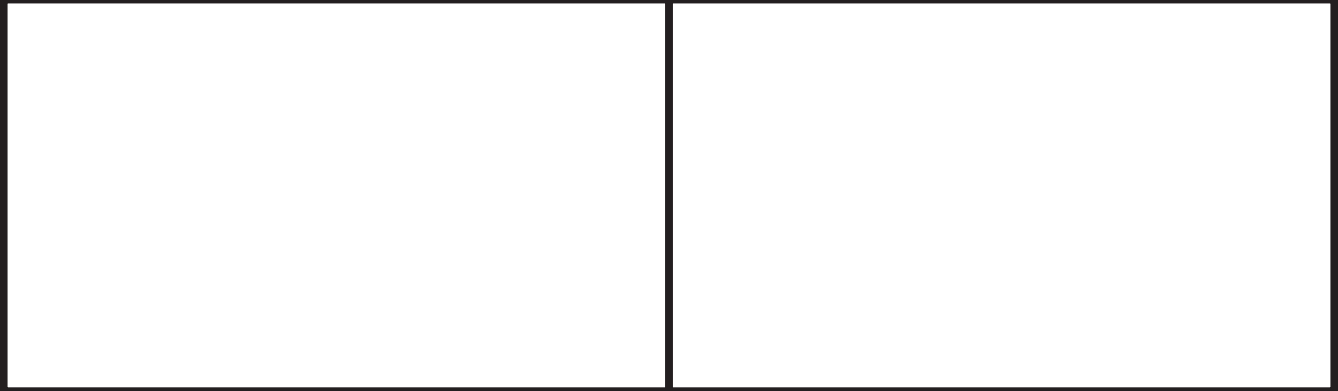
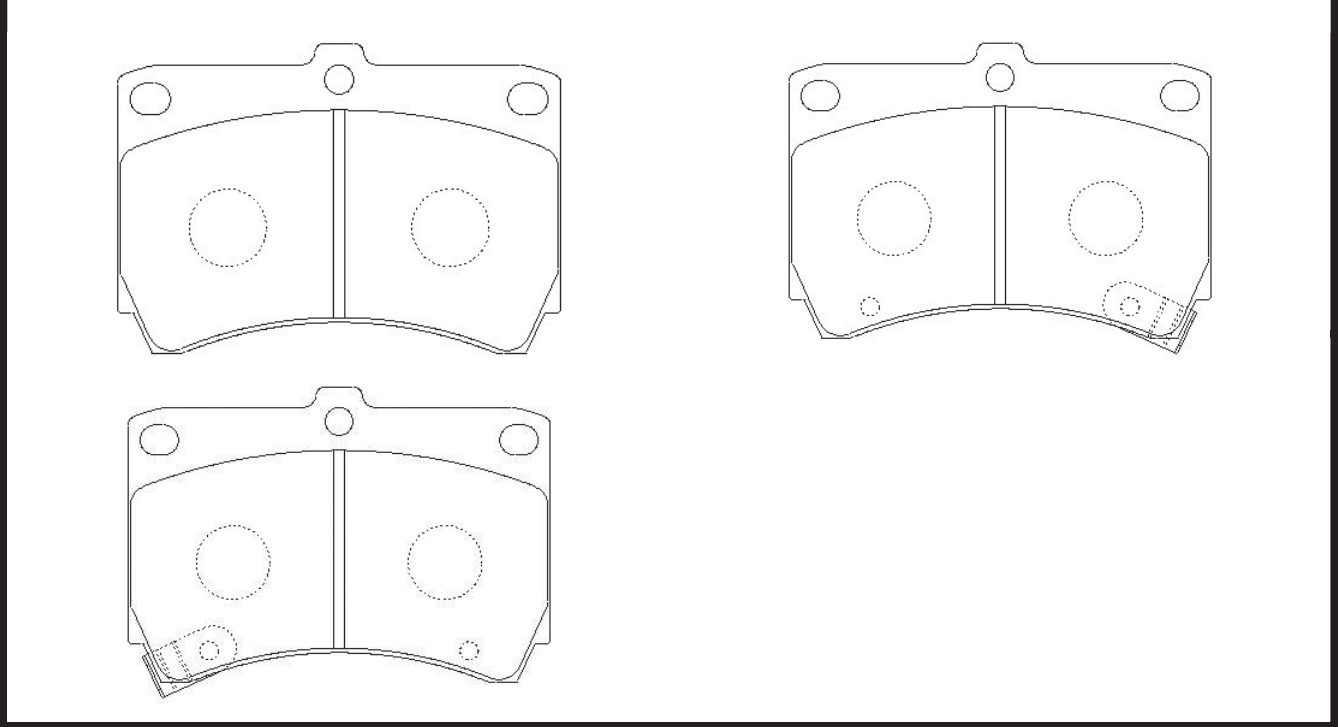

HN-No.	W	H	T	AKNo.	HN-No.	W	H	T	AKNo.
				MKNo.					MKNo.
HN-233						149.8	58.6	15.8	AN-313WK
									D6039M-02

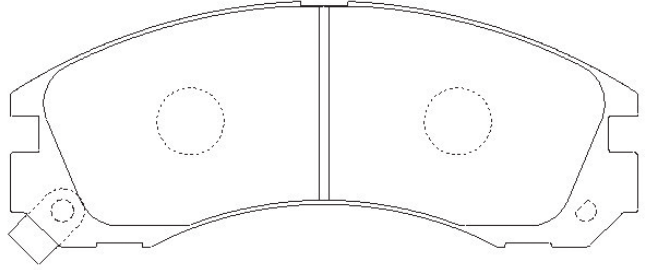
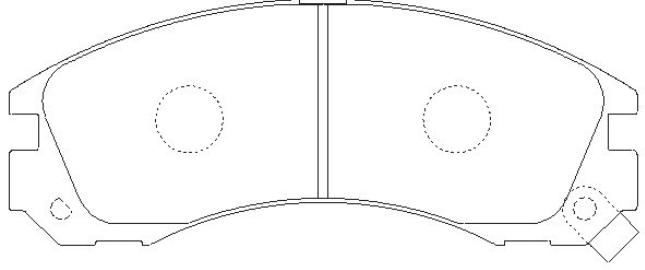
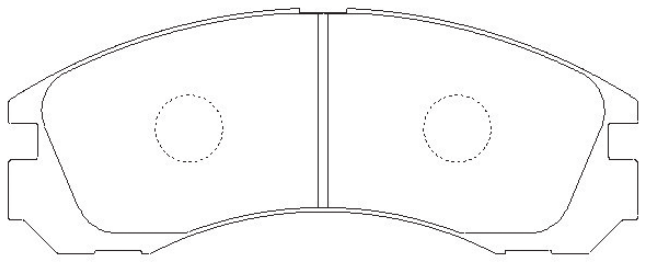

HN-234	114.1	49.8	14.8	AN-317K	HN-237	145.4	57.0	15.5	AN-334K
				D6070-02					D2104-02

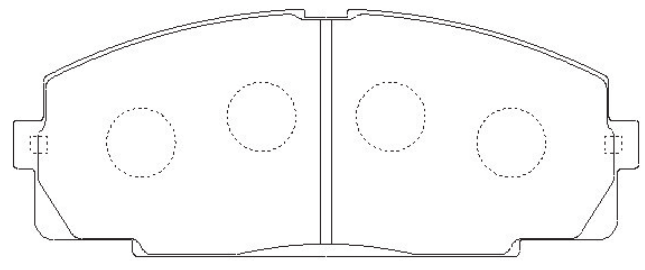
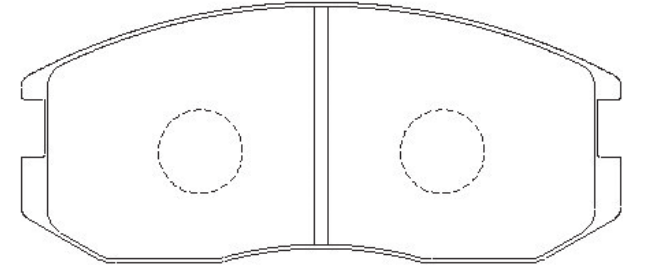

HN-238	100.0	43.5	13.5	AN-384K					
				D3083-02					

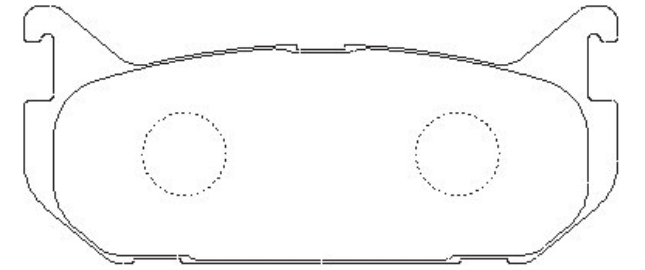

HN-No.	W	H	T	AKNo.	HN-No.	W	H	T	AKNo.
				MKNo.					MKNo.
HN-239									AN-447WK
									D3084M-02

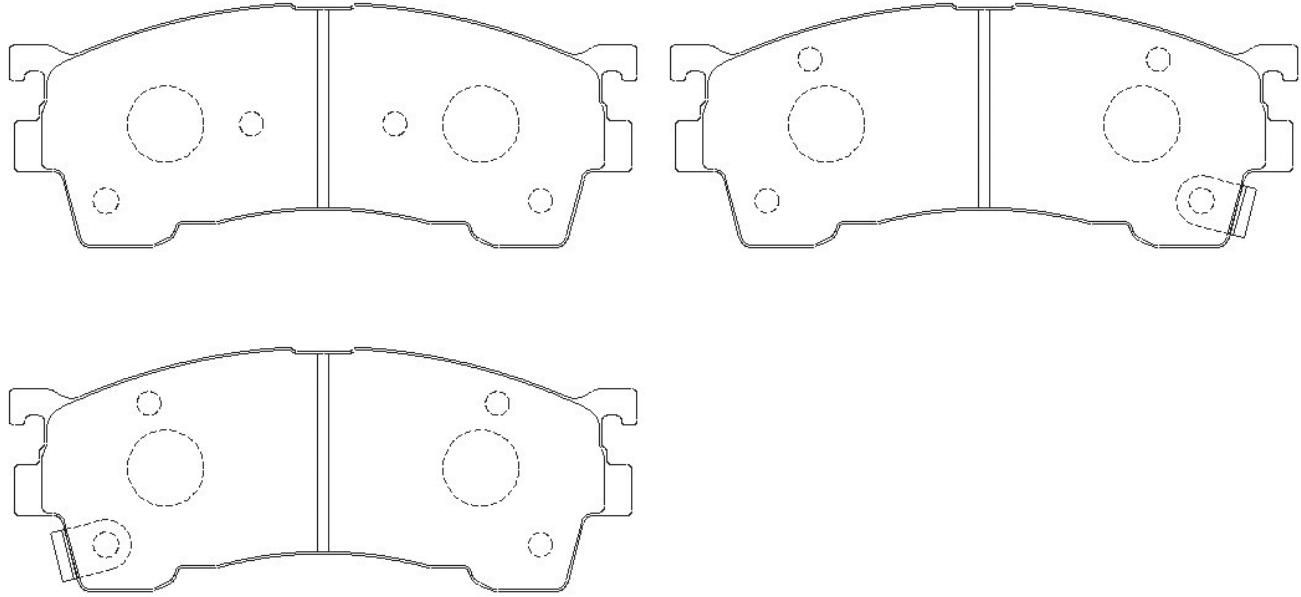

HN-242									AN-336WK
									D2094M-02

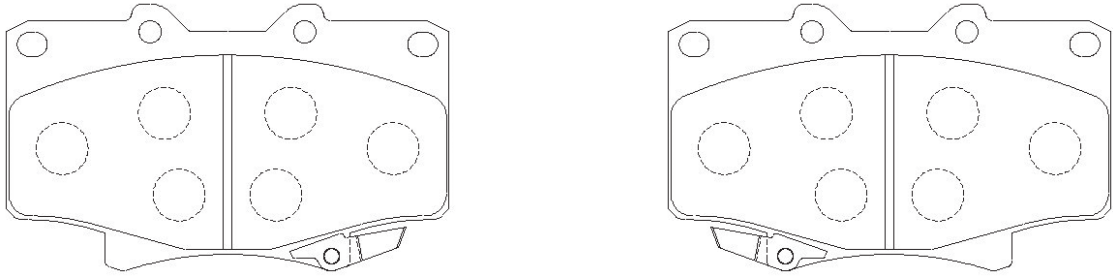

HN-243	116.0	43.3	15.3	AN-337K	HN-244	111.0	40.5	14.3	AN-289K
				D2090-02					D6038-02

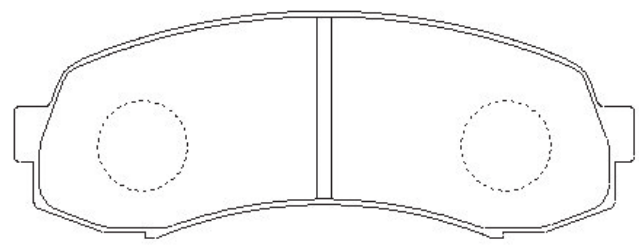
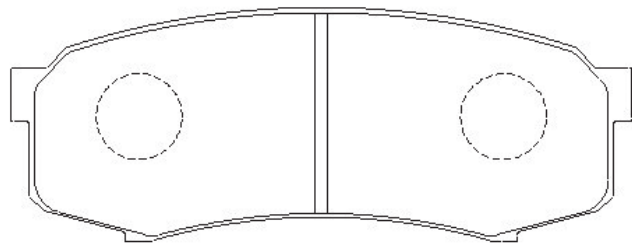

HN-No.	W	H	T	AKNo.	HN-No.	W	H	T	AKNo.
				MKNo.					MKNo.
HN-245						137.0	54.0	15.8	AN-319WK
									D1142M-02

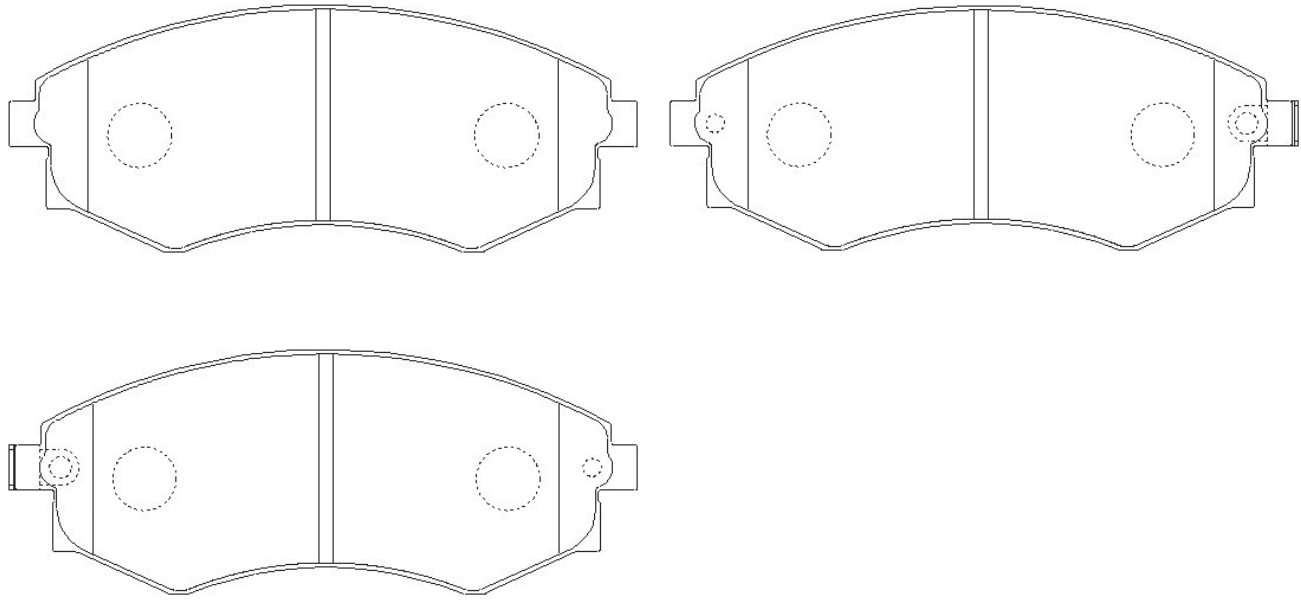

HN-246	116.0	53.3	15.3	AN-275K					
				D2087-02					

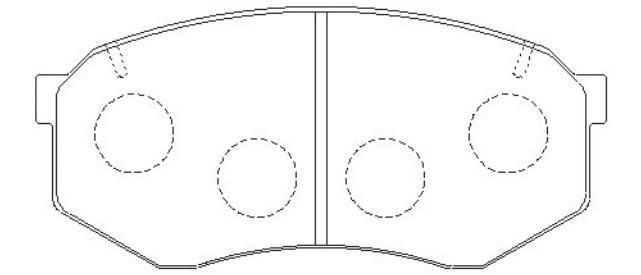

HN-247						127.8	59.0	16.8	AN-296WK
									D7017M-02

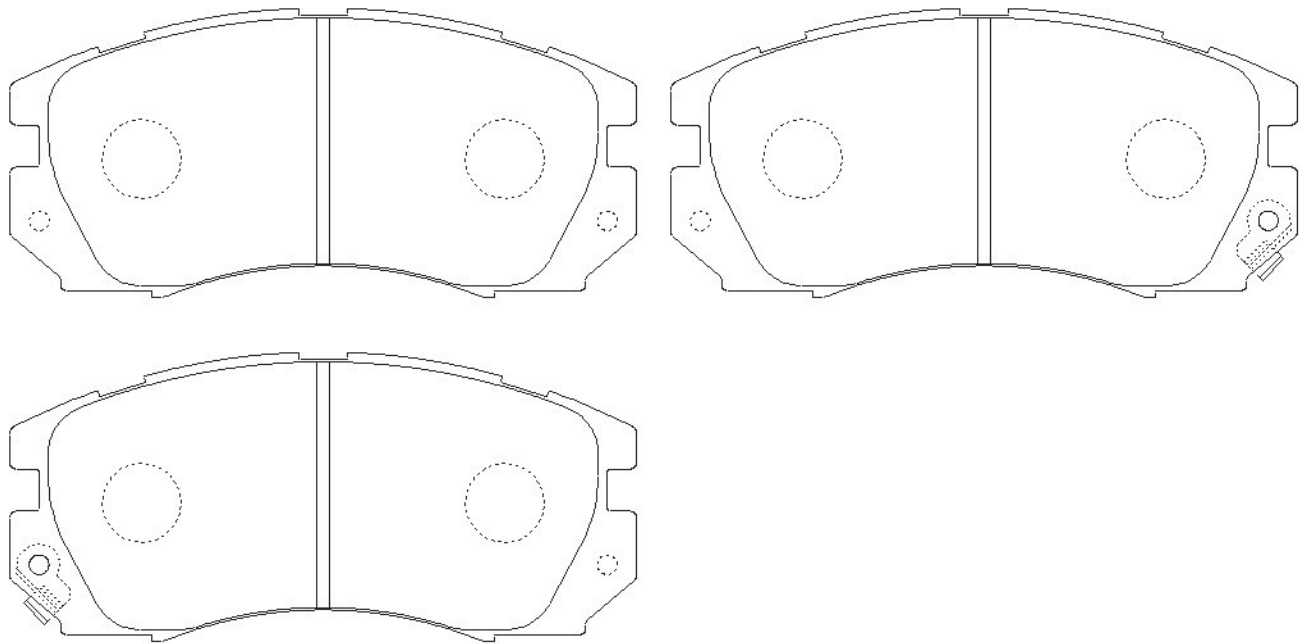

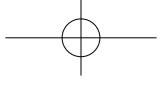

HN-No.	W	H	T	AKNo.	HN-No.	W	H	T	AKNo.
				MKNo.					MKNo.

HN-248						127.8	54.4	17.0	AN-295WK
									D7014M-02

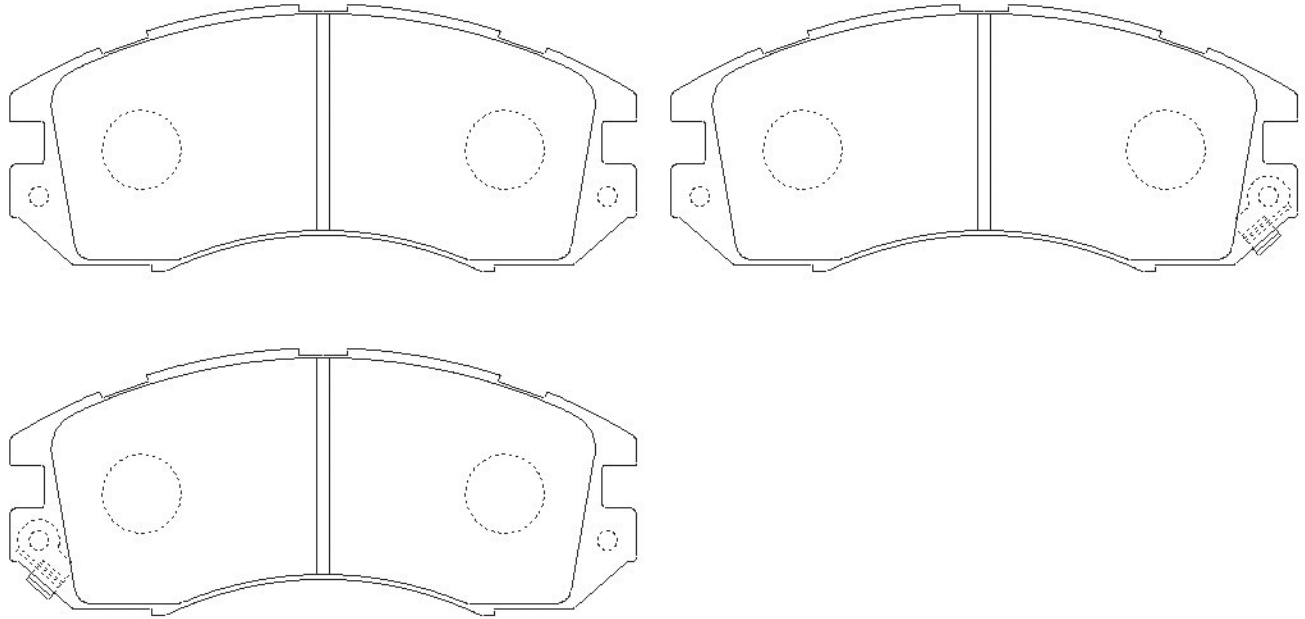

HN-249						107.8	38.6	15.0	AN-297WK
									D7020M-02

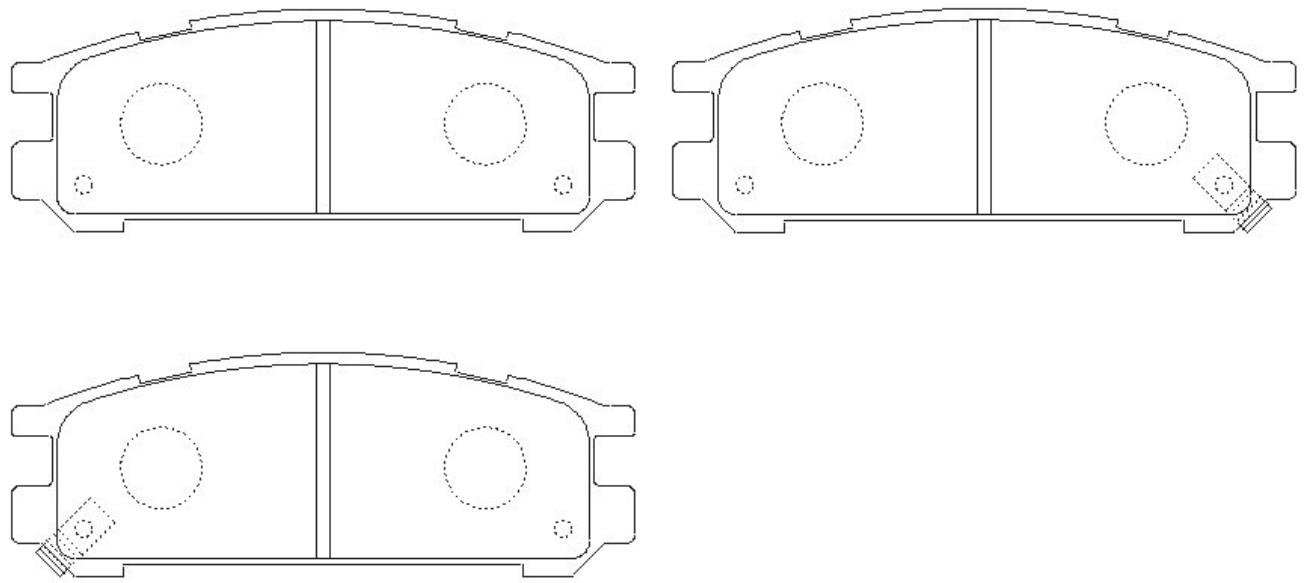

HN-251						120.0	53.0	14.8	AN-335K
									D7026-02

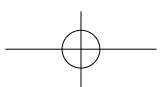
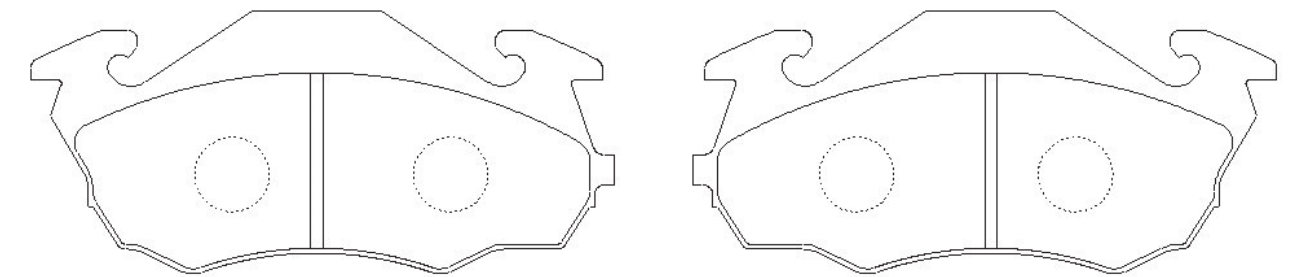

HN-No.	W	H	T	AKNo.	HN-No.	W	H	T	AKNo.
				MKNo.					MKNo.
HN-252	117.0	40.0	15.5	AN-323K	HN-253	110.1	46.0	14.3	AN-324K
				D2089-02					D3061-02

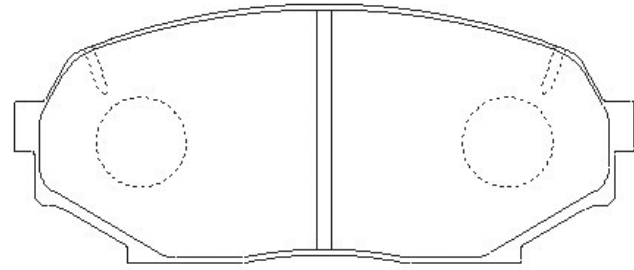
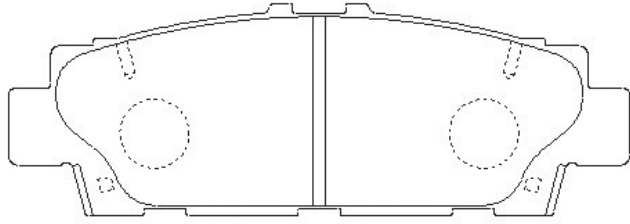

HN-254					148.7	57.0	17.3	AN-358WK
								D5060M-02

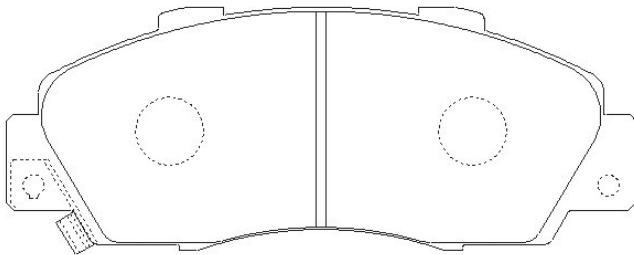
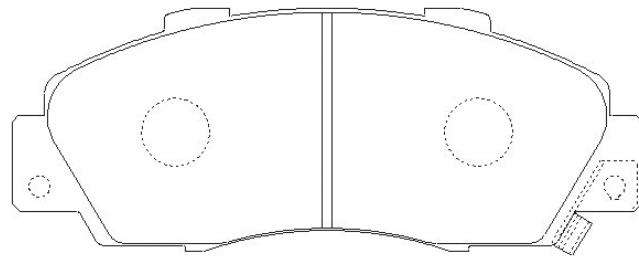
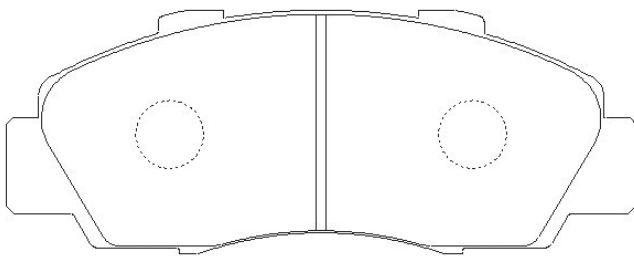

HN-255					89.0	47.0	14.5	AN-359WK
								D5066M-02

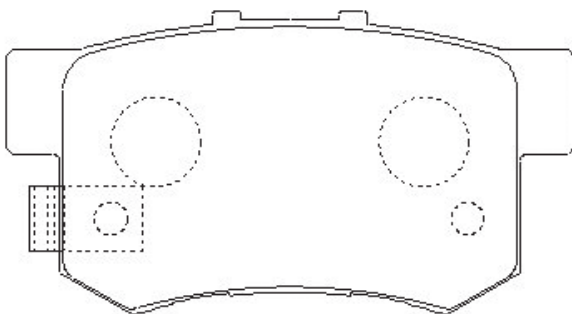
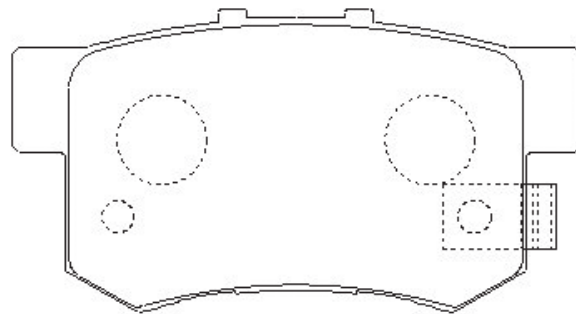
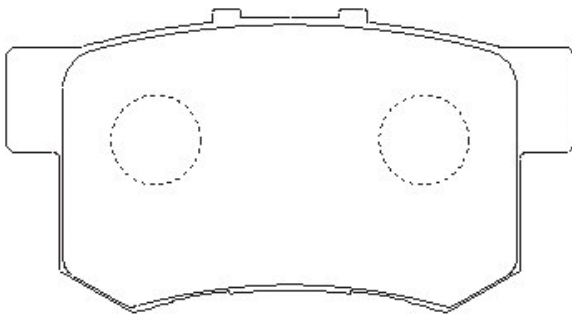

HN-No.	W	H	T	AKNo.	HN-No.	W	H	T	AKNo.
				MKNo.					MKNo.
HN-256									AN-330K
									D2092-02

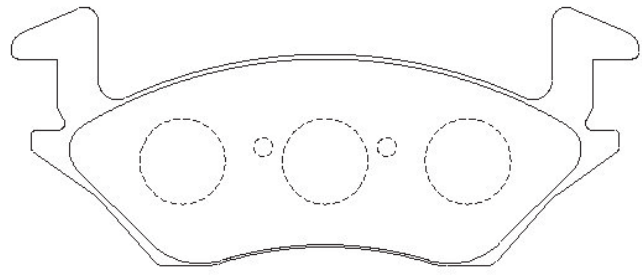
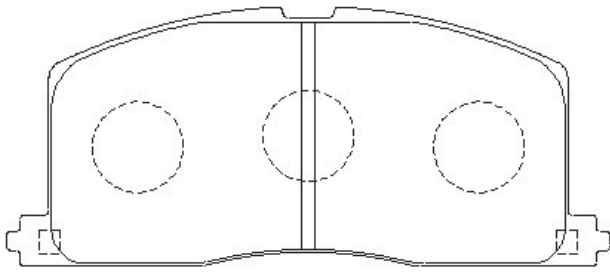

HN-257	110.1	45.0	14.0	AN-347K
				D4025-02

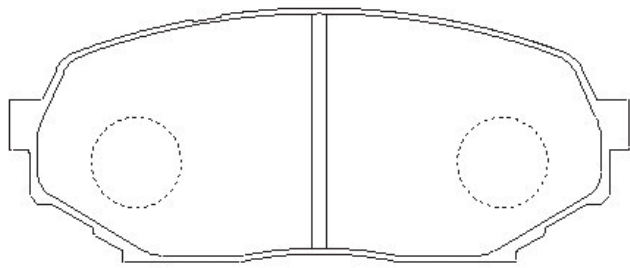

HN-258				AN-386WK
				D4031M-02

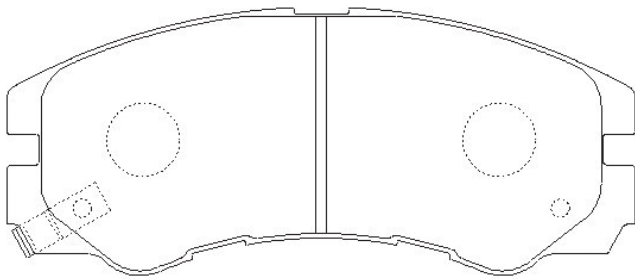
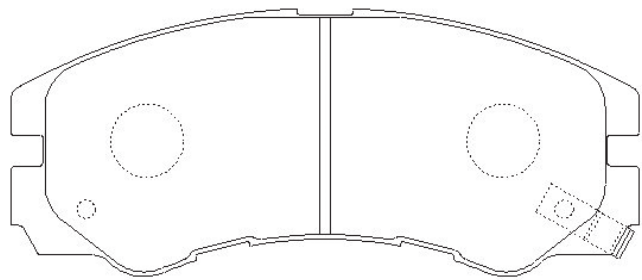
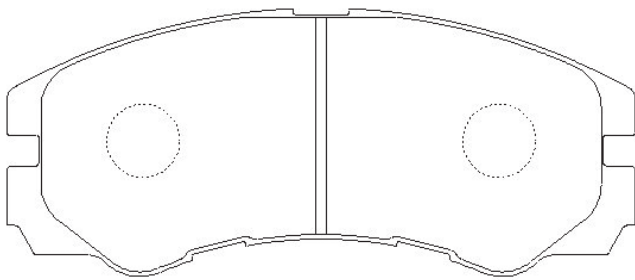

HN-259				AN-355K
				D2102-02

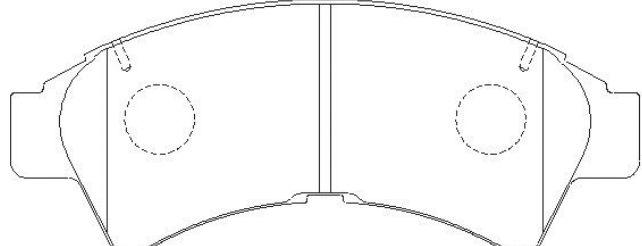
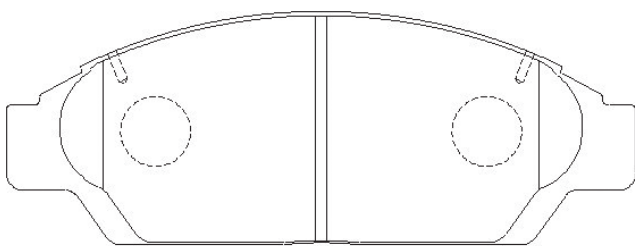

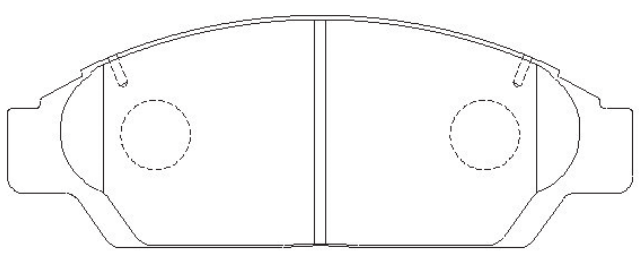
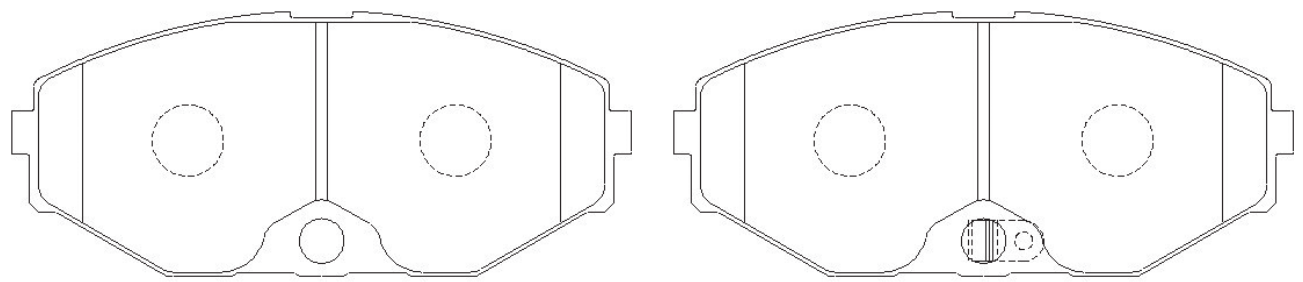
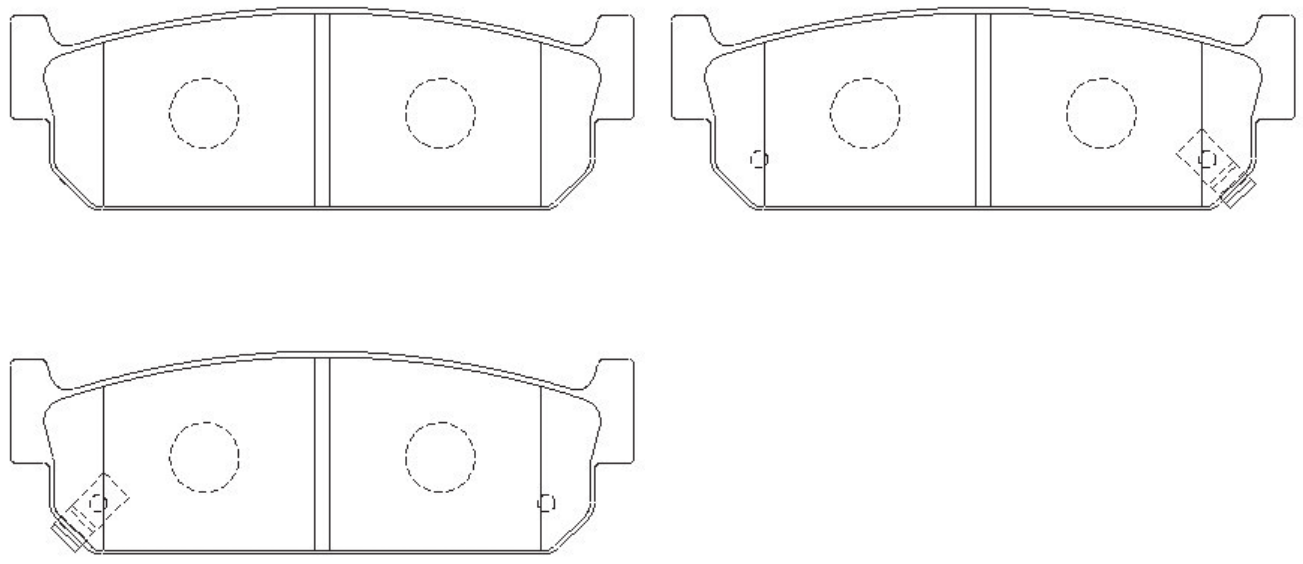
HN-No.	W	H	T	AKNo.	HN-No.	W	H	T	AKNo.
				MKNo.					MKNo.
HN-260	144.4	53.0	15.5	AN-354K					
				D2109-02					
									
HN-261					139.1	59.5	14.8		AN-372WK
									D1165M-02
									
HN-262					108.5	35.2	15.0		AN-373WK
									D1167M-02
									

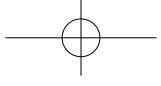

HN-No.	W	H	T	AKNo.	HN-No.	W	H	T	AKNo.
				MKNo.					MKNo.
HN-263						116.0	45.0	14.9	AN-378WK
									D5019M-02

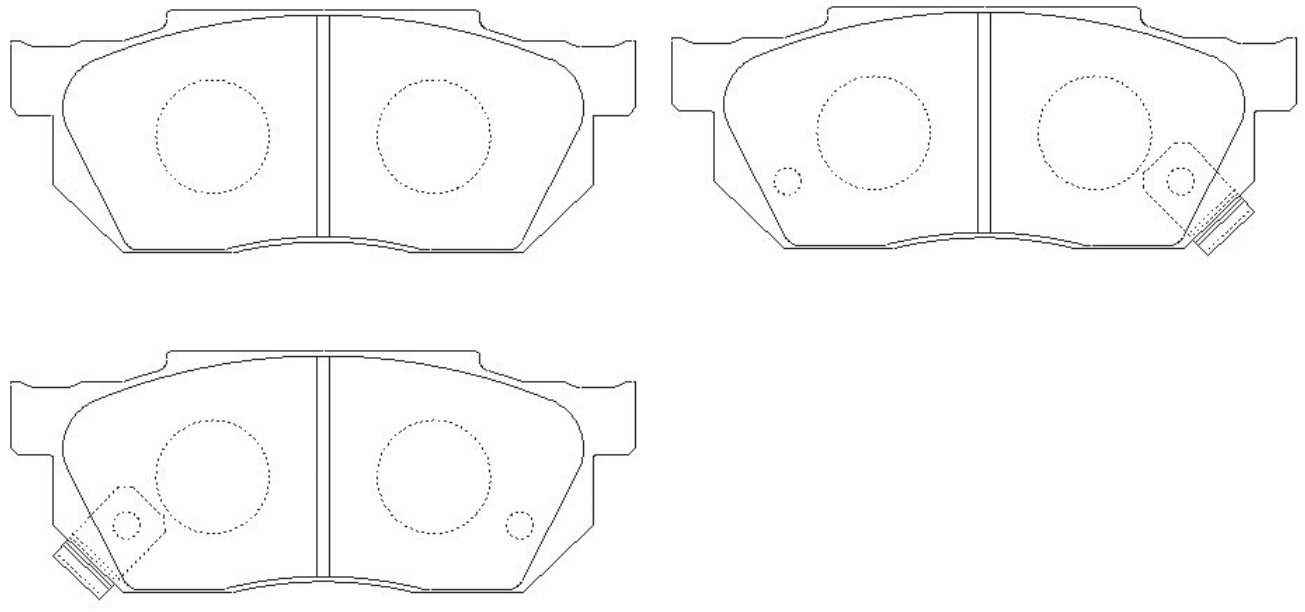

HN-264				136.5		53.4	16.3	AN-376WK
								D5070M-02

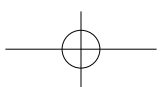
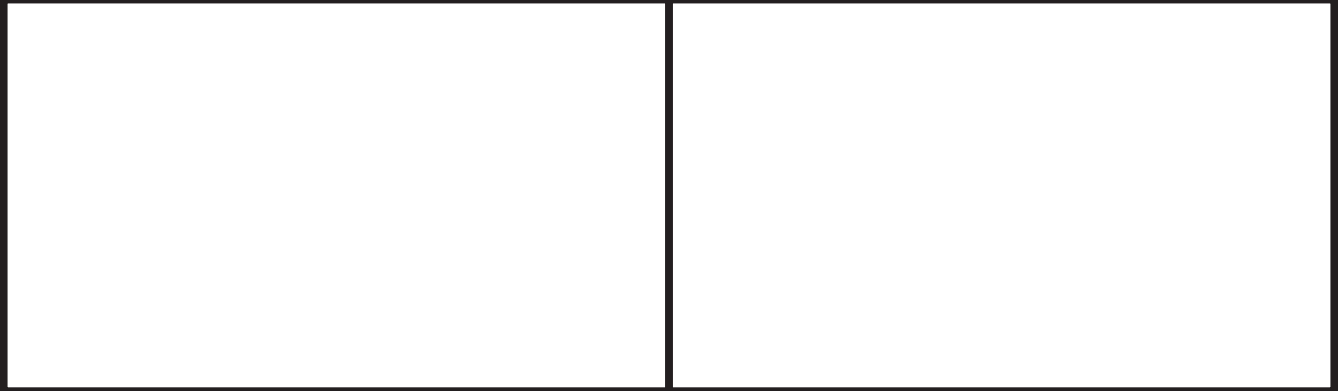
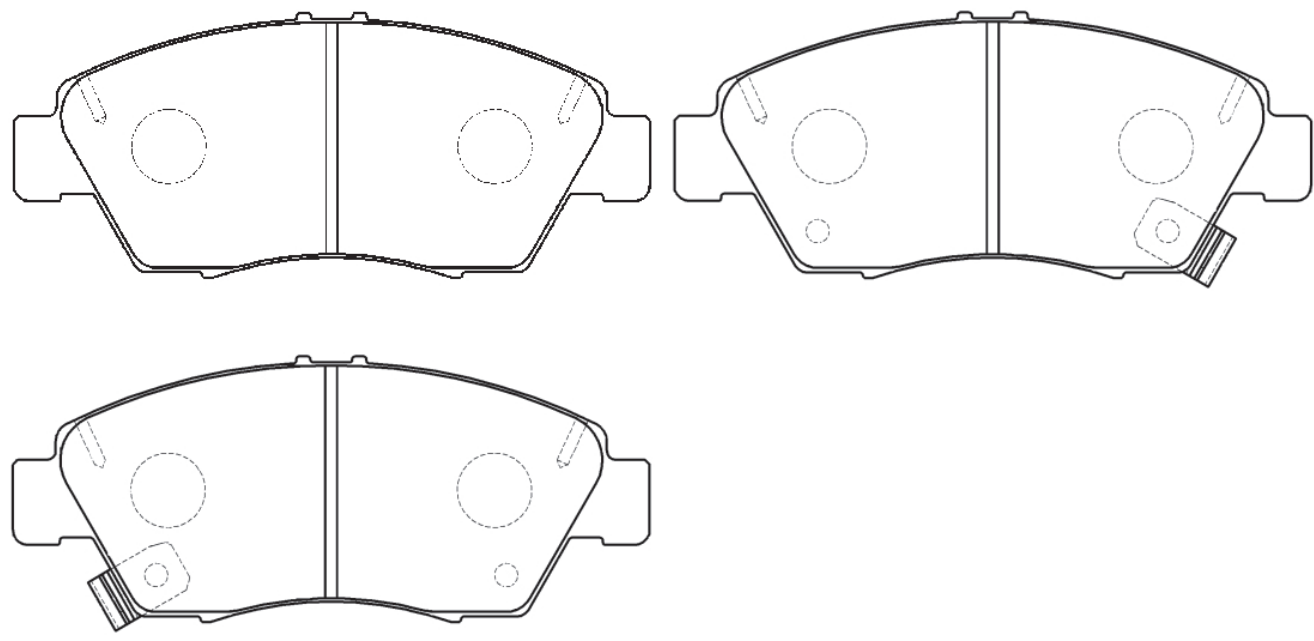

HN-No.	W	H	T	AKNo.	HN-No.	W	H	T	AKNo.
				MKNo.					MKNo.
HN-265						131.3	54.2	14.6	AN-377WK
									D5073M-02

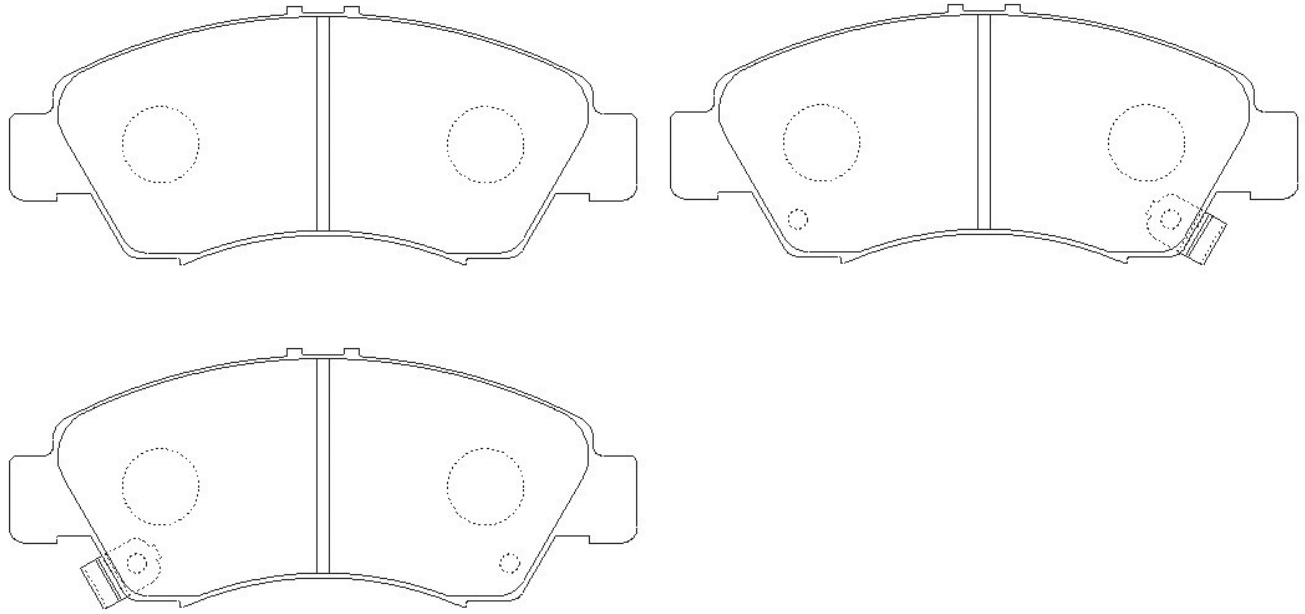

HN-266				89.0	36.5	12.6	AN-411WK
							D5042M-02

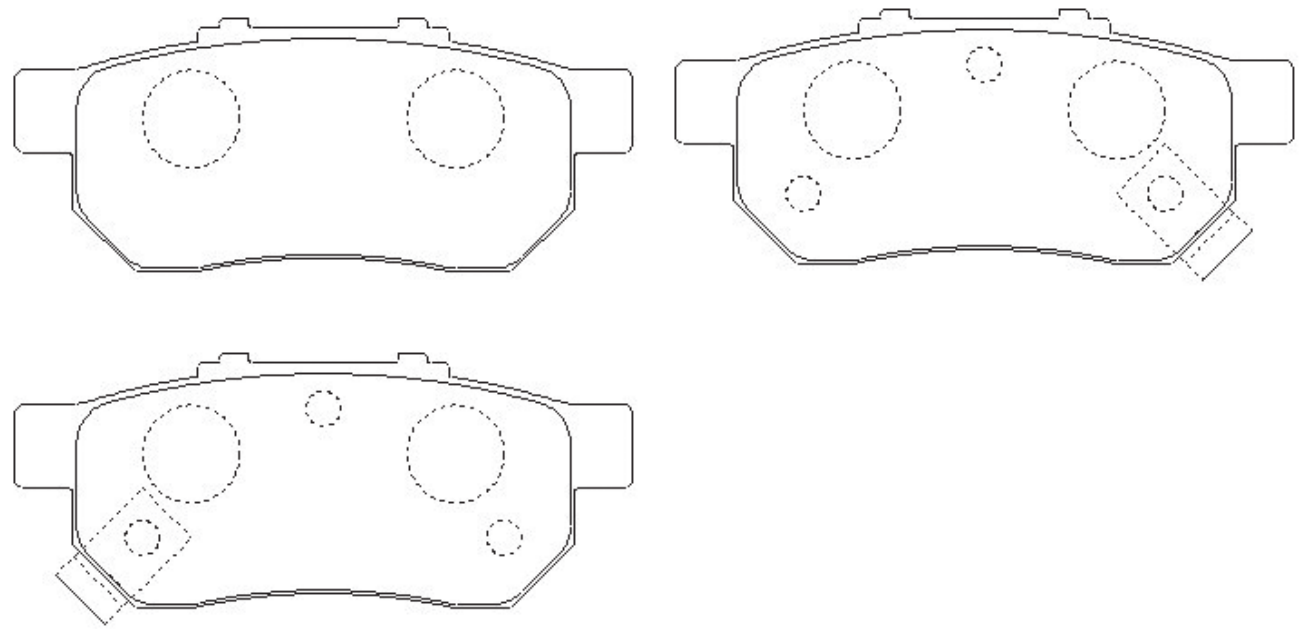

HN-267	141.0	56.0	15.5	AN-374K
				D2108-02

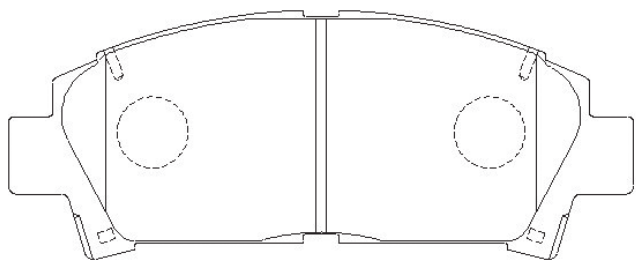

HN-No.	W	H	T	AKNo.	HN-No.	W	H	T	AKNo.
				MKNo.					MKNo.
HN-268						127.8	51.0	14.8	AN-350WK
									D1151M-02

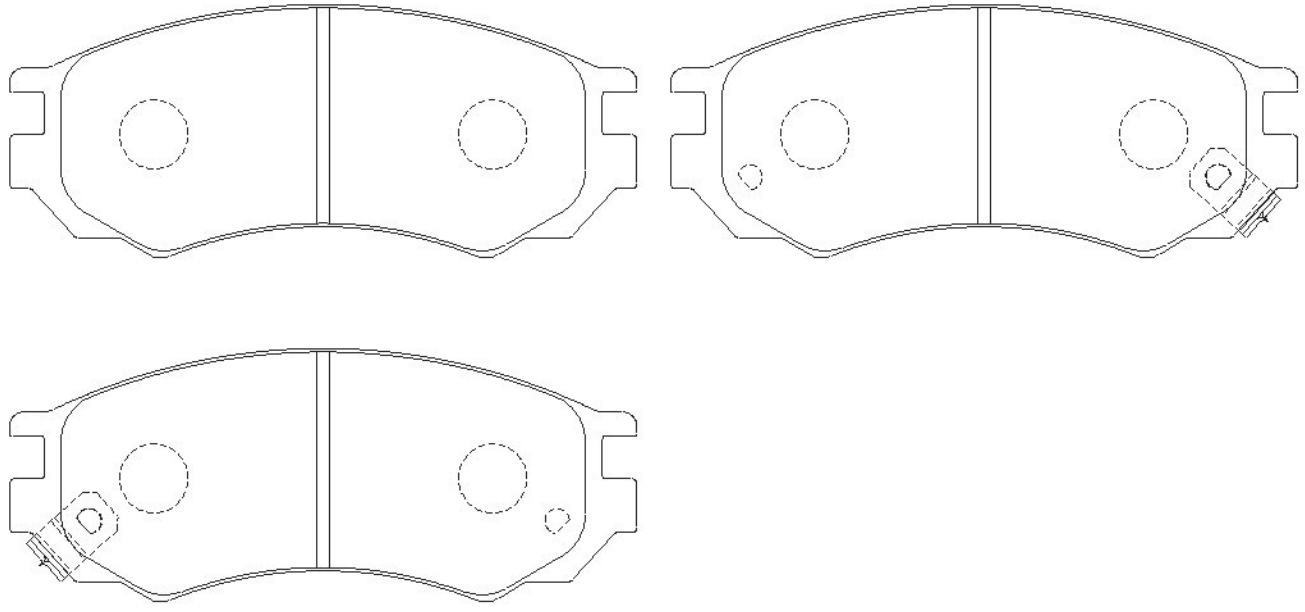

HN-270				98.8		34.7	15.0	AN-349WK
								D1145M-02

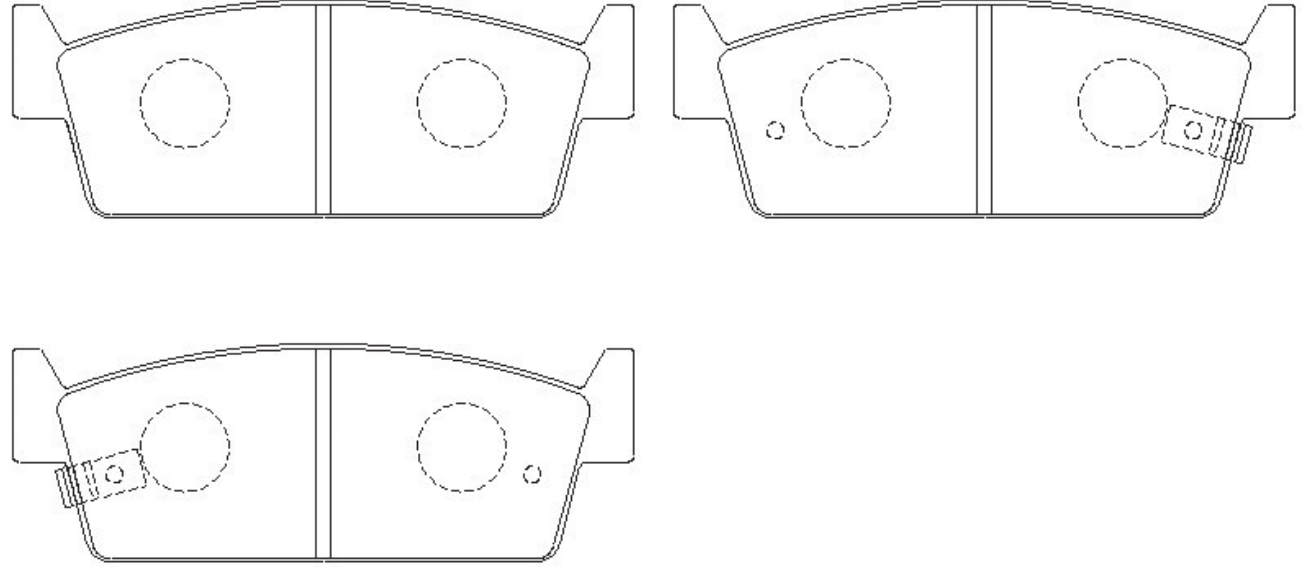

HN-No.	W	H	T	AKNo.	HN-No.	W	H	T	AKNo.
				MKNo.					MKNo.
HN-271						127.8	52.0	15.5	AN-312WK
									D6043M-02

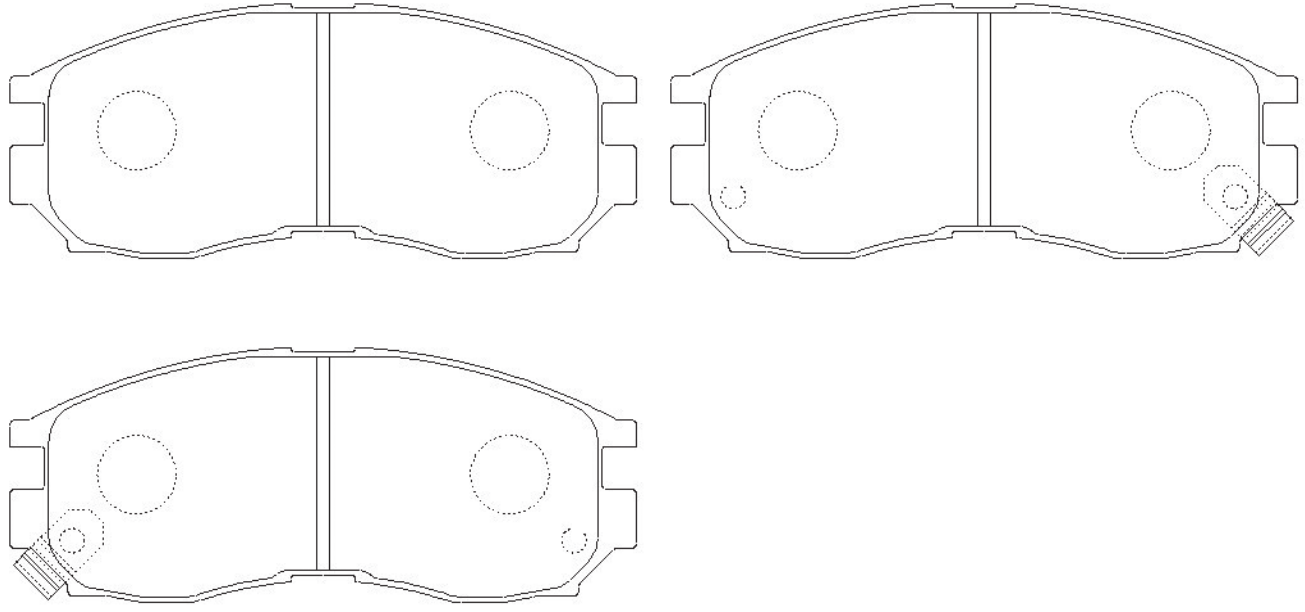

HN-272						107.8	46.0	15.0	AN-348WK
									D6049M-02

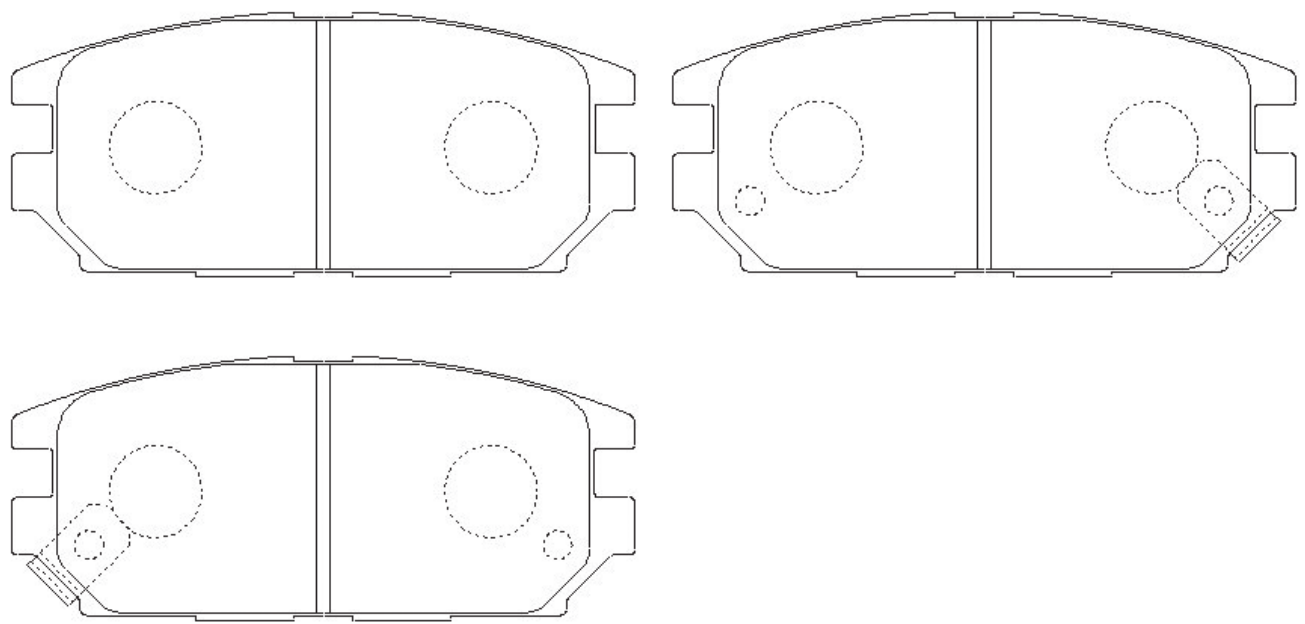

HN-No.	W	H	T	AKNo.	HN-No.	W	H	T	AKNo.
				MKNo.					MKNo.
HN-273									AN-379WK
									D2106M-02

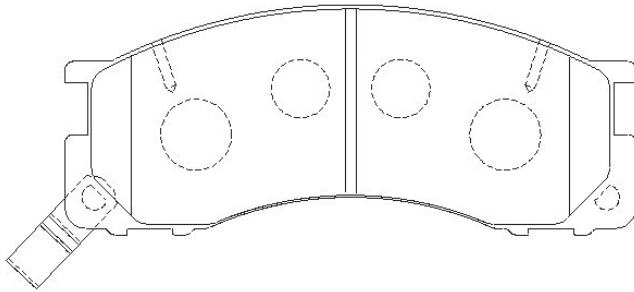
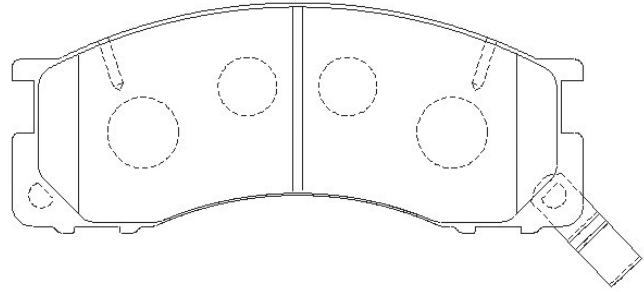
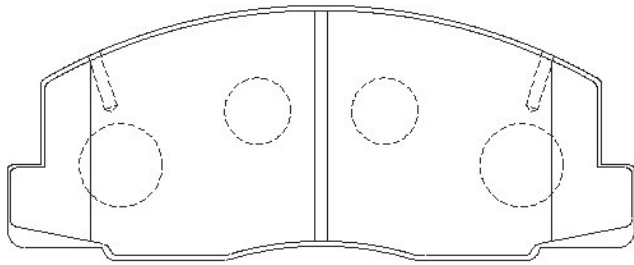

HN-274	119.6	42.5	15.3	AN-340K D2105-02	HN-275	140.4	52.0	15.5	AN-320K D2091-02
--------	-------	------	------	---------------------	--------	-------	------	------	---------------------

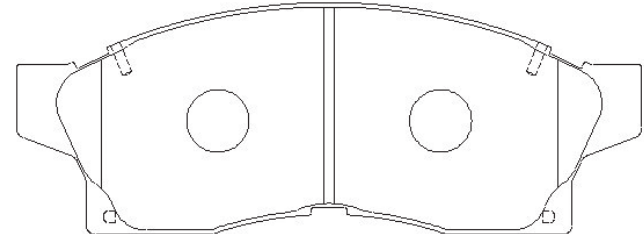
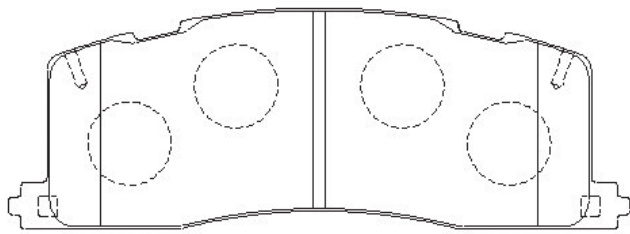

HN-277					85.4	34.5	12.8	AN-392WK D1181M-02
--------	--	--	--	--	------	------	------	-----------------------

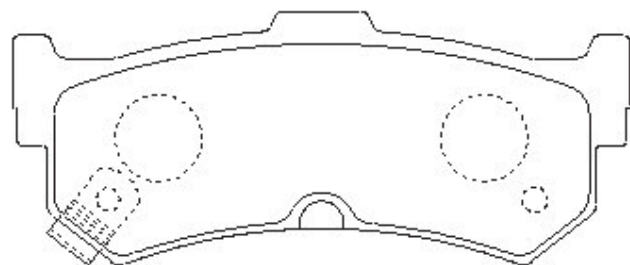
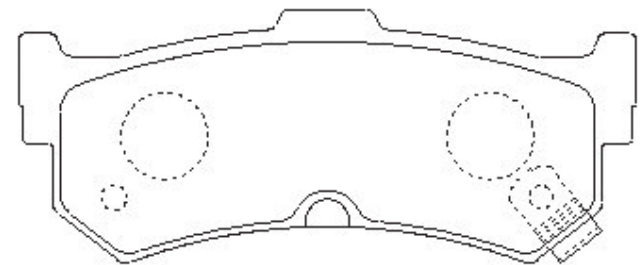
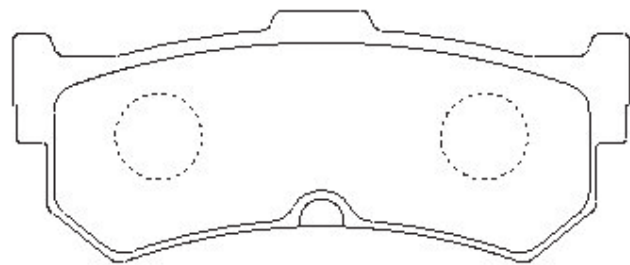

HN-No.	W	H	T	AKNo.	HN-No.	W	H	T	AKNo.
				MKNo.					MKNo.
HN-278	104.0	43.0	14.3	AN-332K					
				D5034-02					
HN-280						107.8	43.5	14.3	AN-366WK
									D6054M-02
HN-281	119.7	53.7	14.9	AN-306K					
				D2065-02					

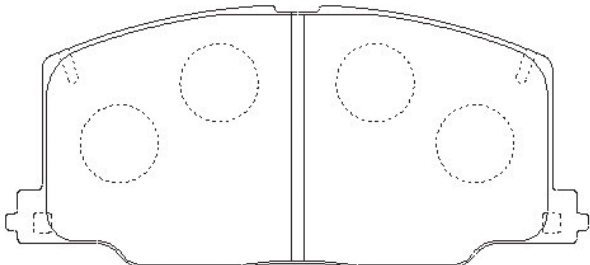
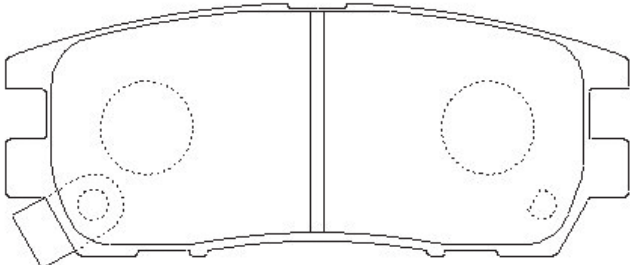
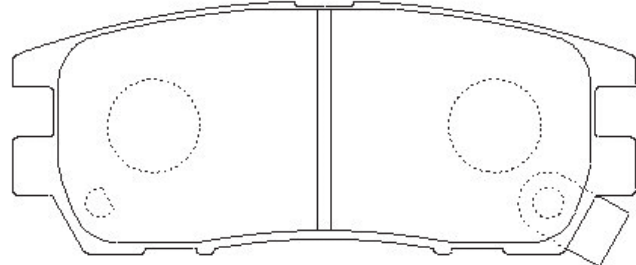
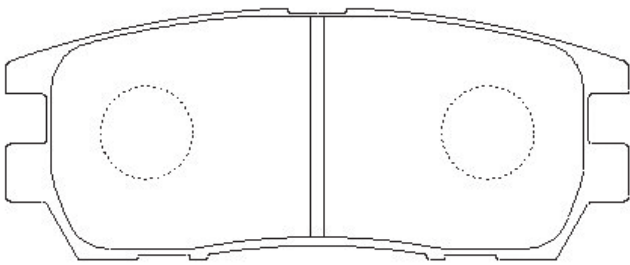
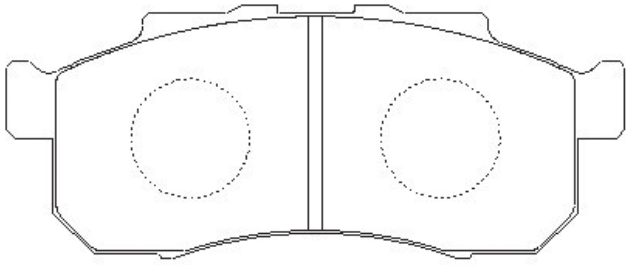

HN-No.	W	H	T	AKNo.	HN-No.	W	H	T	AKNo.
				MKNo.					MKNo.
HN-283									AN-326WK
									D1139M-02

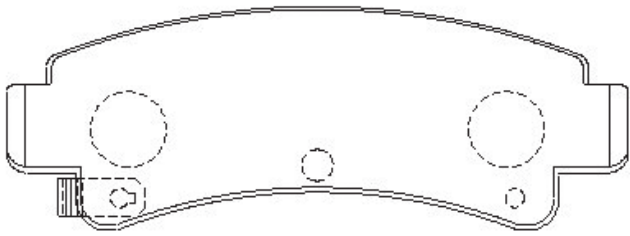
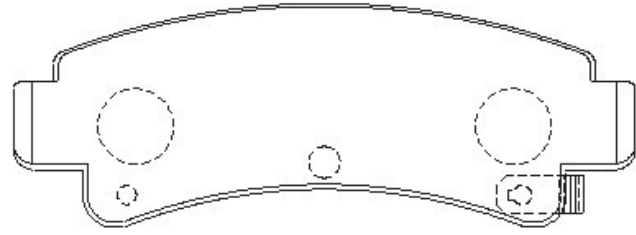
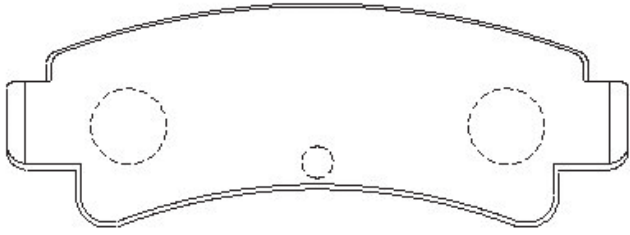

HN-284	98.3	44.5	14.0	AN-314K	HN-285	114.1	49.8	14.8	AN-317K
				D6046-02					

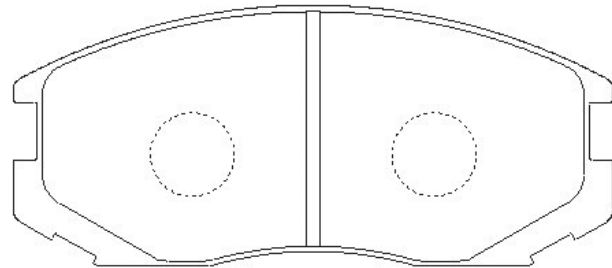
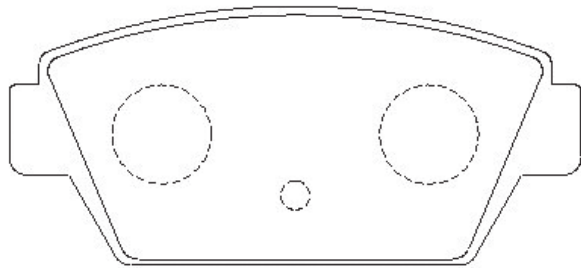

HN-286	114.1	49.8	15.8	AN-385K					
				D6066-02					

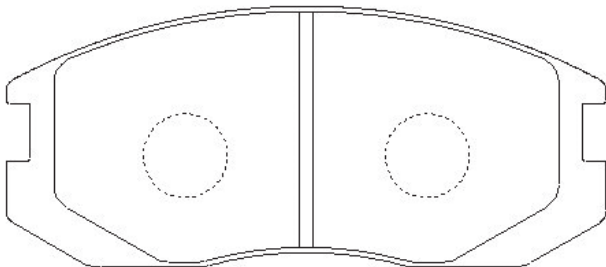

HN-No.	W	H	T	AKNo.	HN-No.	W	H	T	AKNo.
				MKNo.					MKNo.
HN-287				148.6					AN-362WK
				219.7					56.5

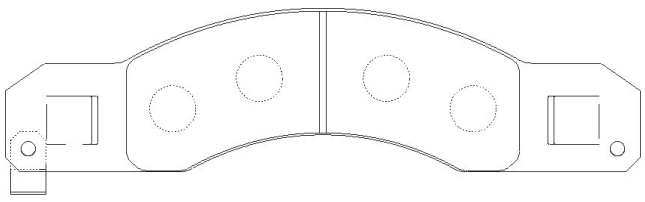
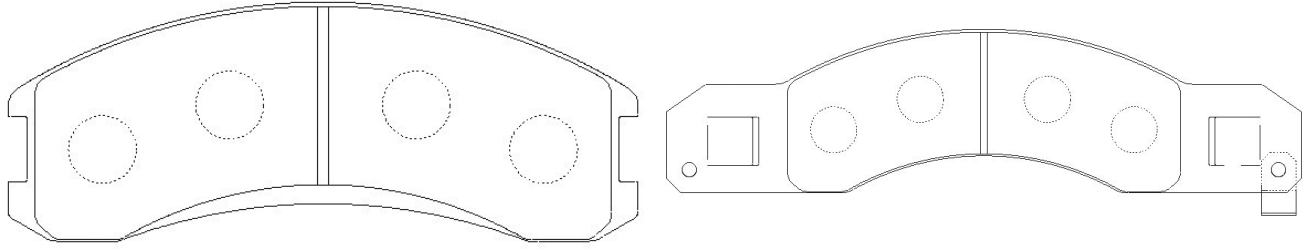

HN-288				183.4					AN-360WK
				238.0					69.7

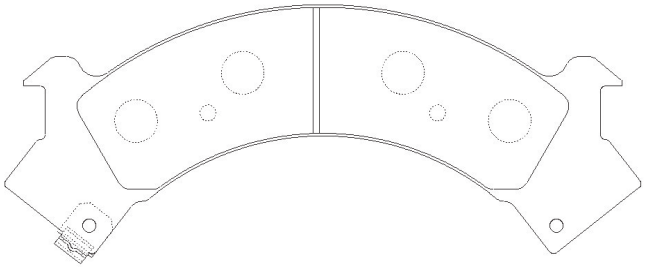
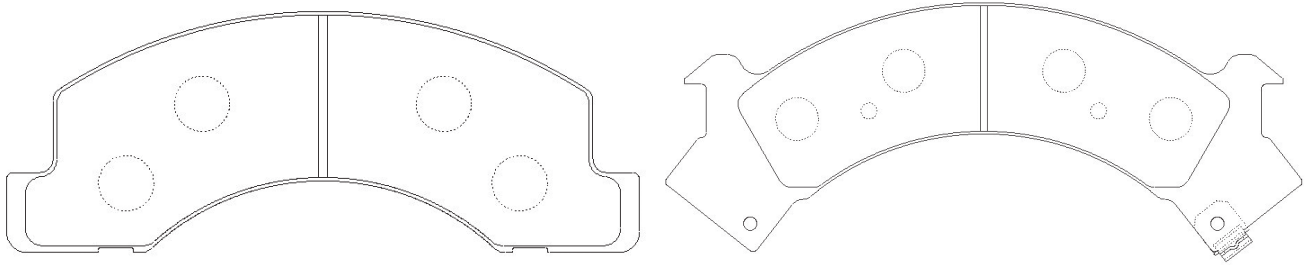

HN-No.	W	H	T	AKNo.	HN-No.	W	H	T	AKNo.
				MKNo.					MKNo.
HN-289						175.7	63.0	18.7	AN-361WK
									D4037M-02

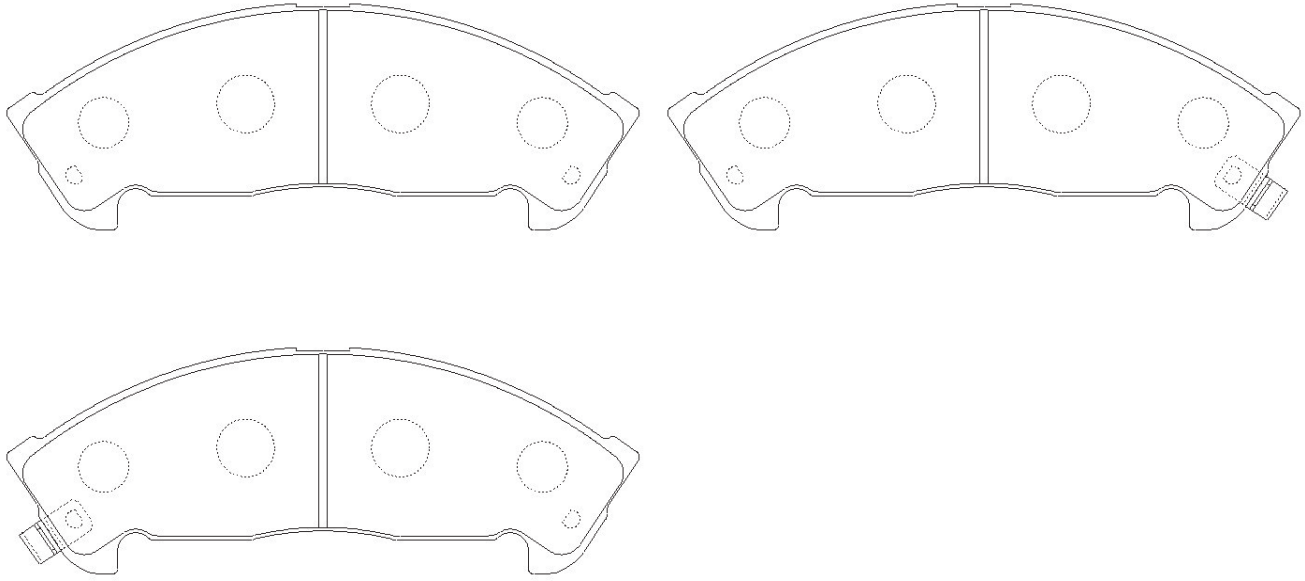

HN-290						117.2	42.8	14.3	AN-344WK
						117.2	42.8	15.3	D3079M-02

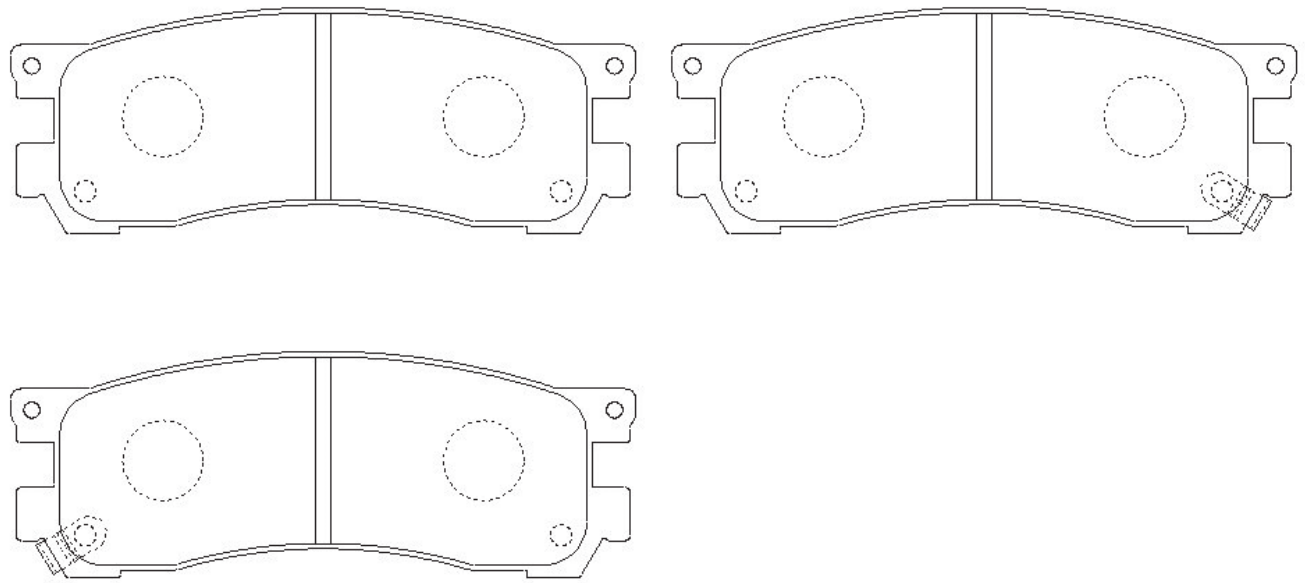

HN-291	127.6	53.2	13.5	AN-304K					
				D0022-02					

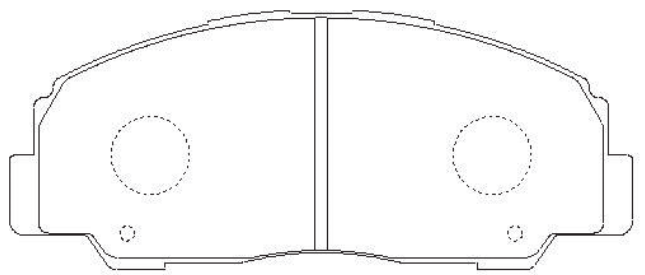

HN-No.	W	H	T	AKNo.	HN-No.	W	H	T	AKNo.
				MKNo.					MKNo.
HN-293						137.8	53.7	18.3	AN-375WK
									D5077M-02

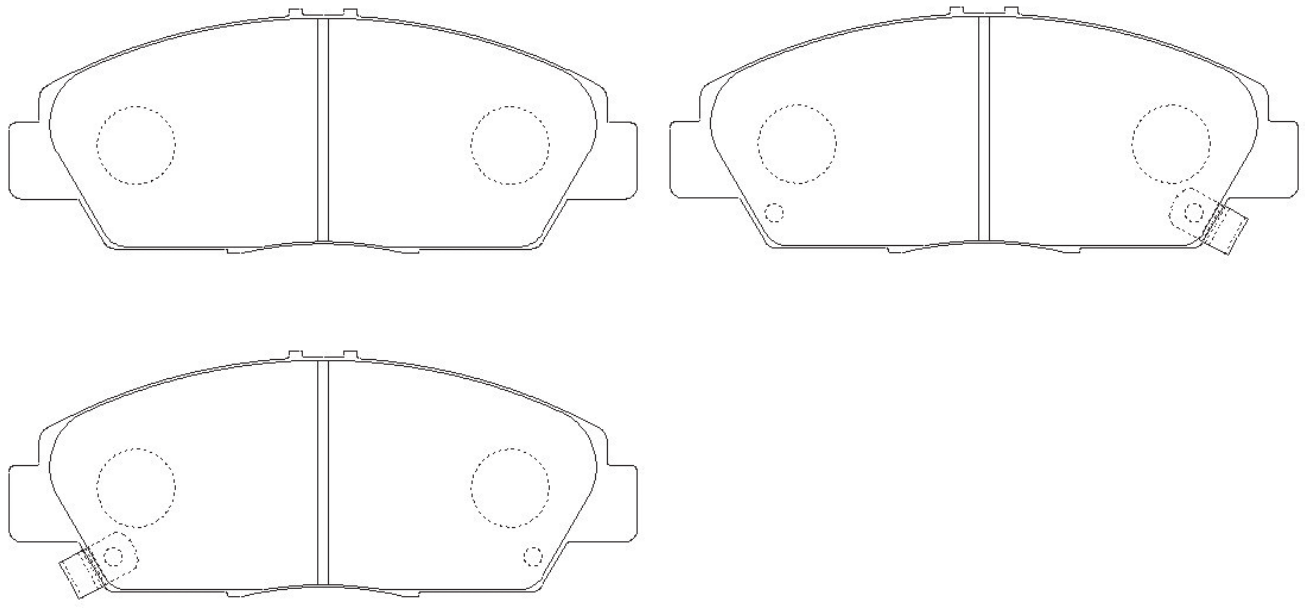

HN-294						137.8	53.5	15.8	AN-367WK
									D3074M-02

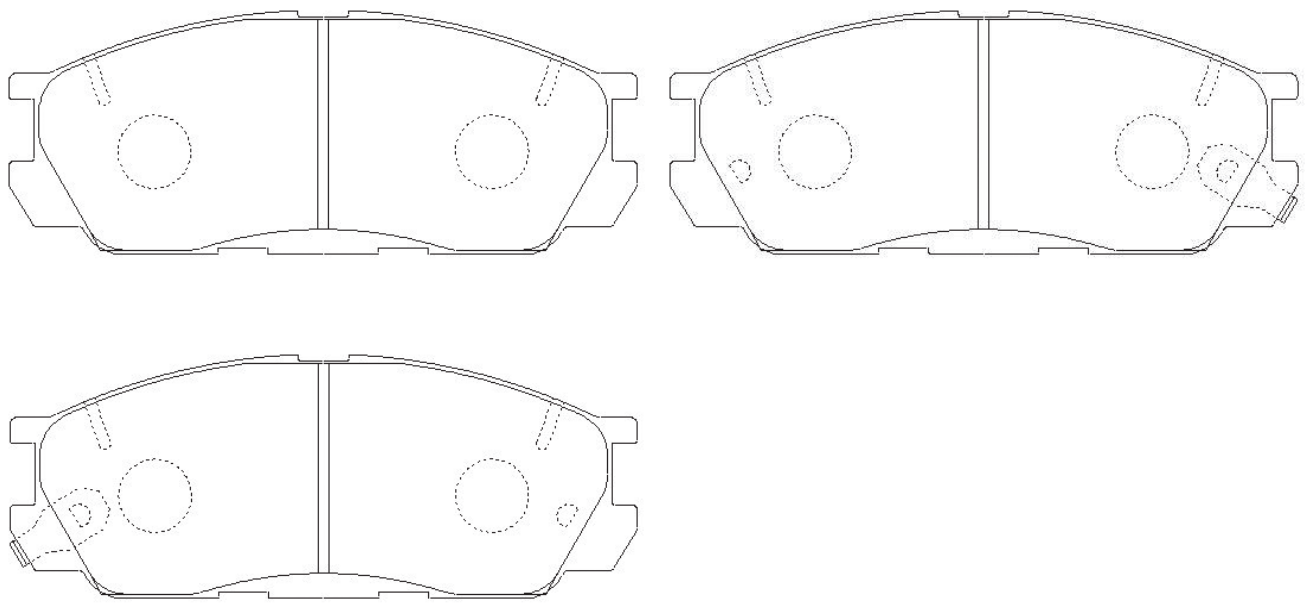

HN-295	104.6	45.0	13.8	AN-389K					
				D0026-02					

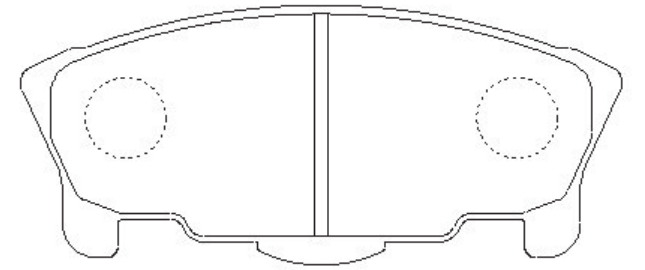

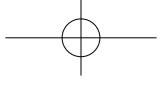

HN-No.	W	H	T	AKNo.	HN-No.	W	H	T	AKNo.
				MKNo.					MKNo.
HN-296						107.9	46.3	14.8	AN-339WK
									D4026M-02

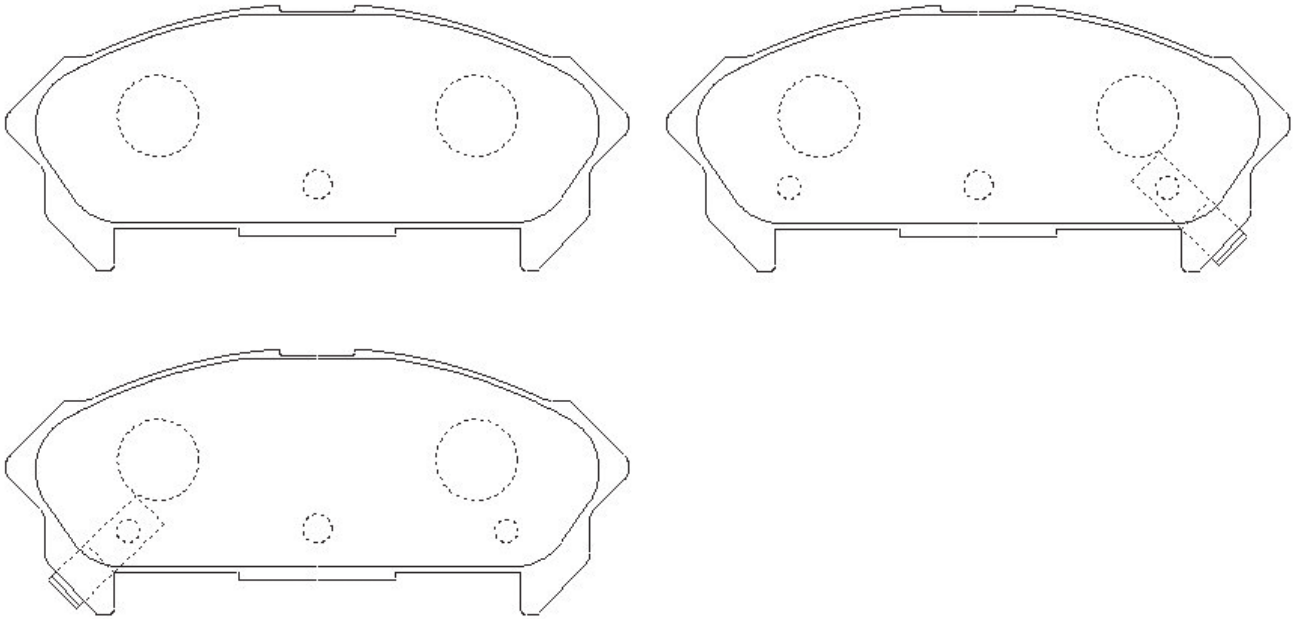

HN-297						127.7	52.5	15.3	AN-357WK
									D3035M-02

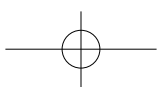
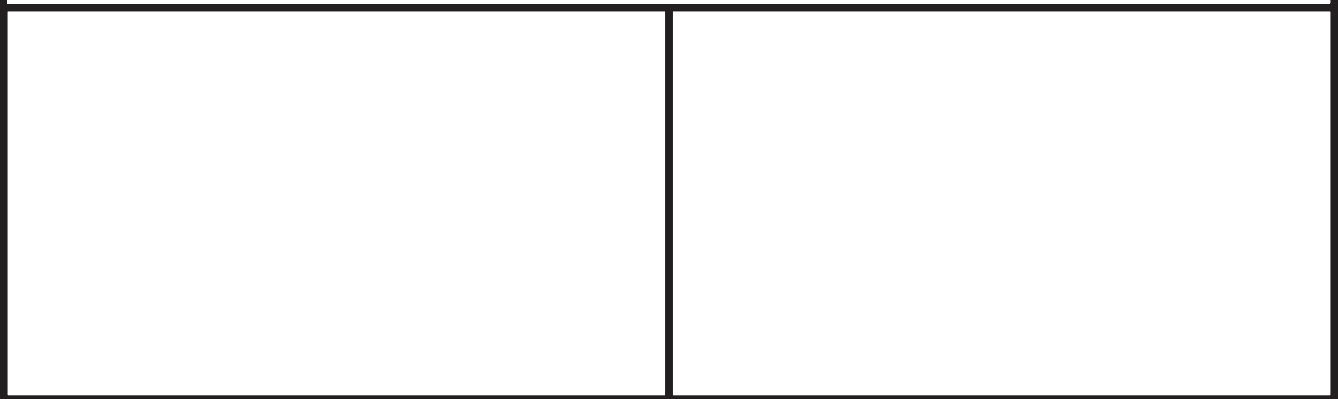
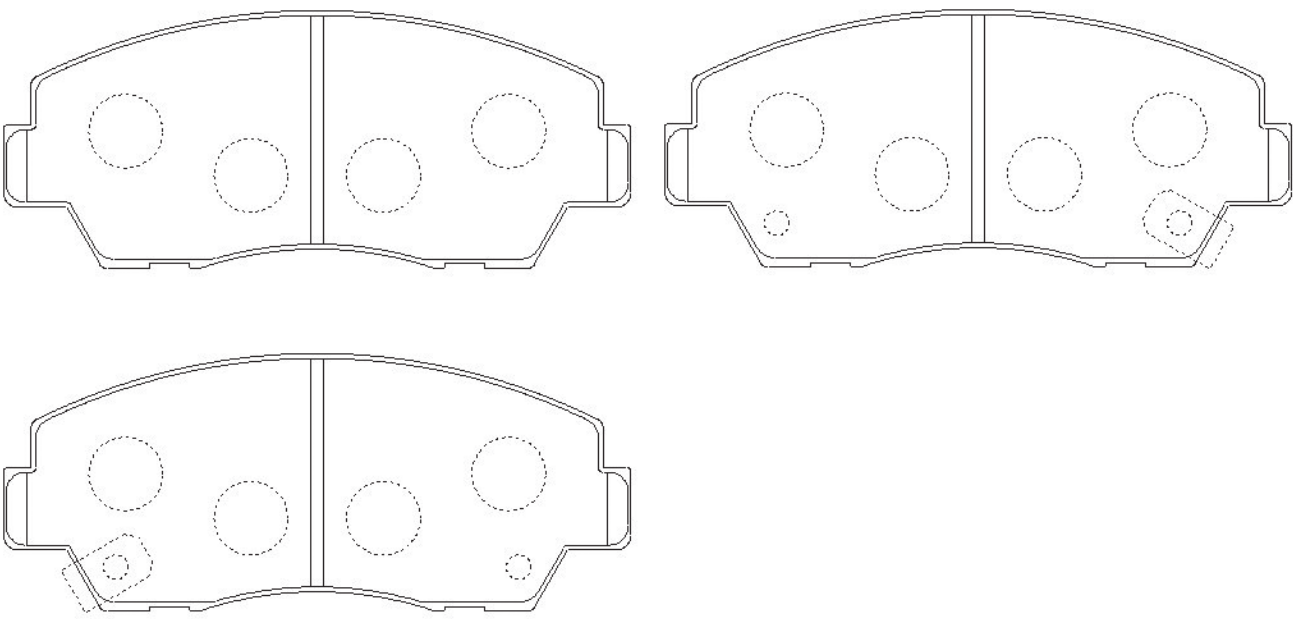

HN-No.	W	H	T	AKNo.	HN-No.	W	H	T	AKNo.
				MKNo.					MKNo.
HN-298						103.4	43.5	14.8	AN-273WK
									D9010M-02

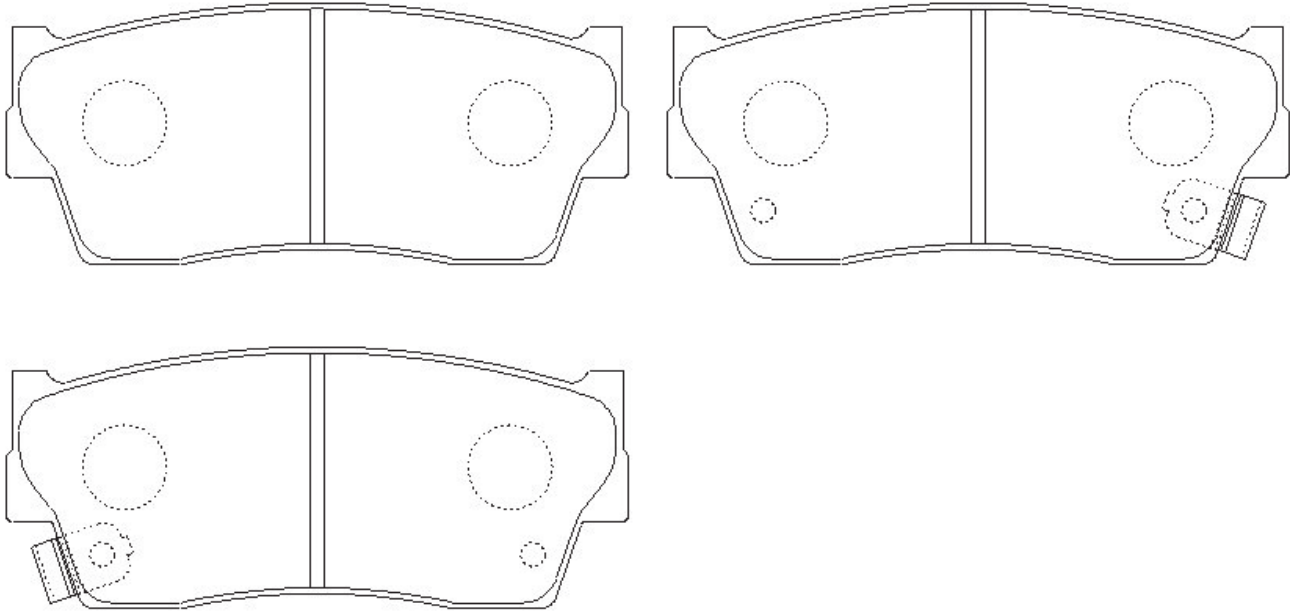

HN-299						109.6	42.5	15.5	AN-387WK
									D4034M-02

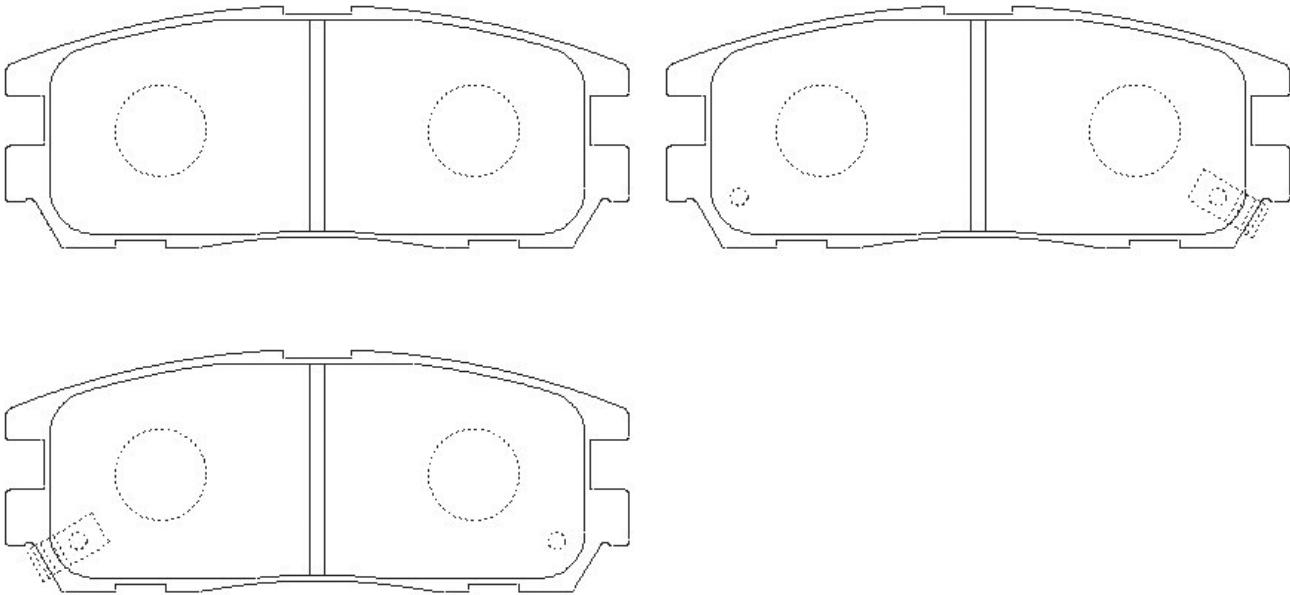

HN-300	128.0	53.3	15.3	AN-343K					
				D3082-02					

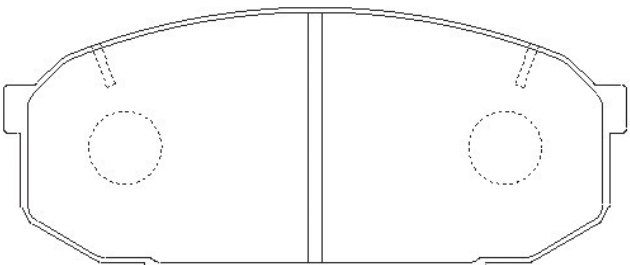

HN-No.	W	H	T	AKNo.	HN-No.	W	H	T	AKNo.
				MKNo.					MKNo.
HN-301						116.5	45.5	15.3	AN-370WK
									D9019M-02

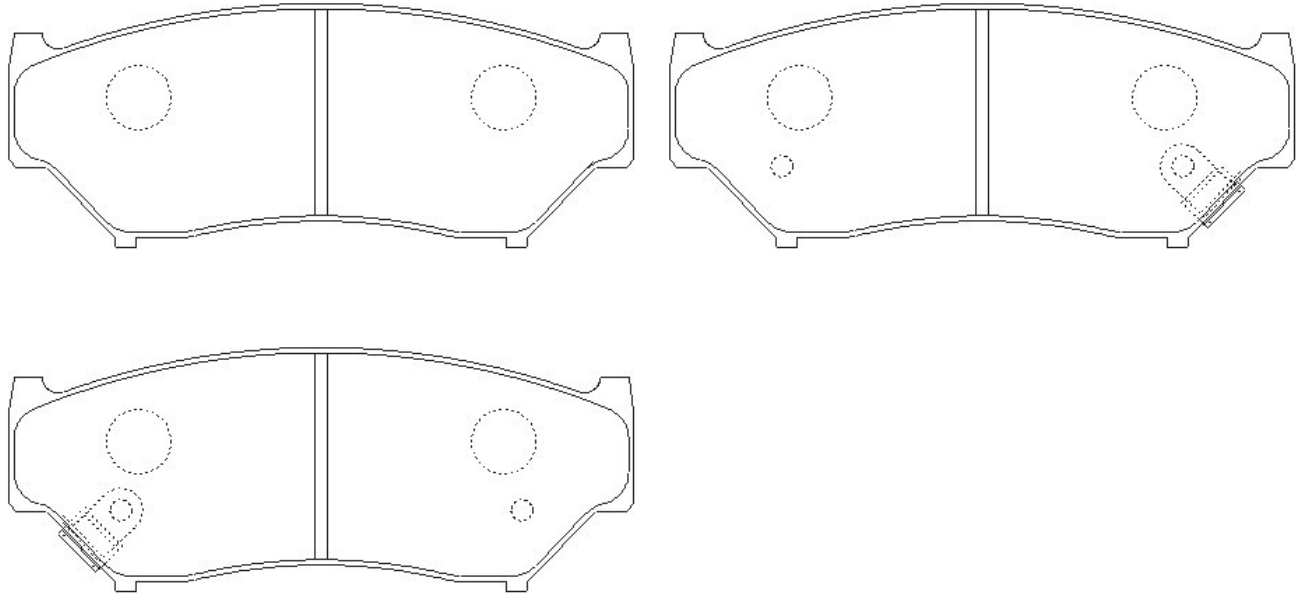

HN-303				133.1		56.1	15.3	AN-328WK
								D3069M-02

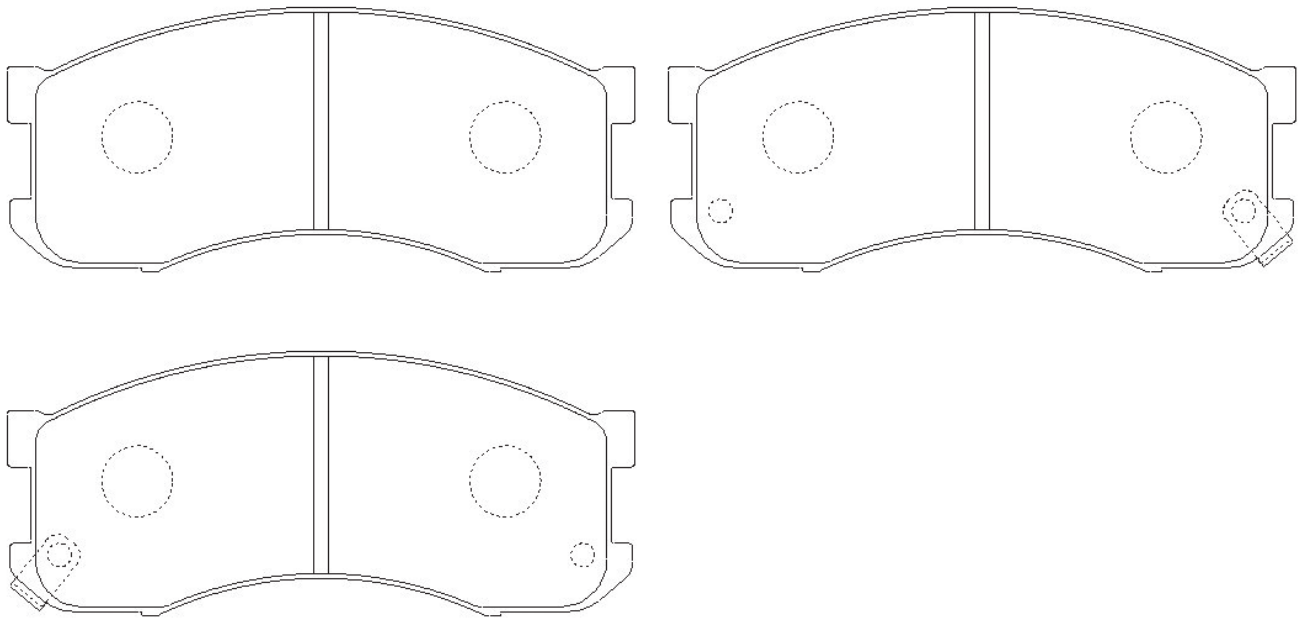

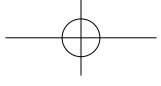

HN-No.	W	H	T	AKNo.	HN-No.	W	H	T	AKNo.
				MKNo.					MKNo.
HN-304						114.8	45.0	15.8	AN-266WK
									D1102M-02

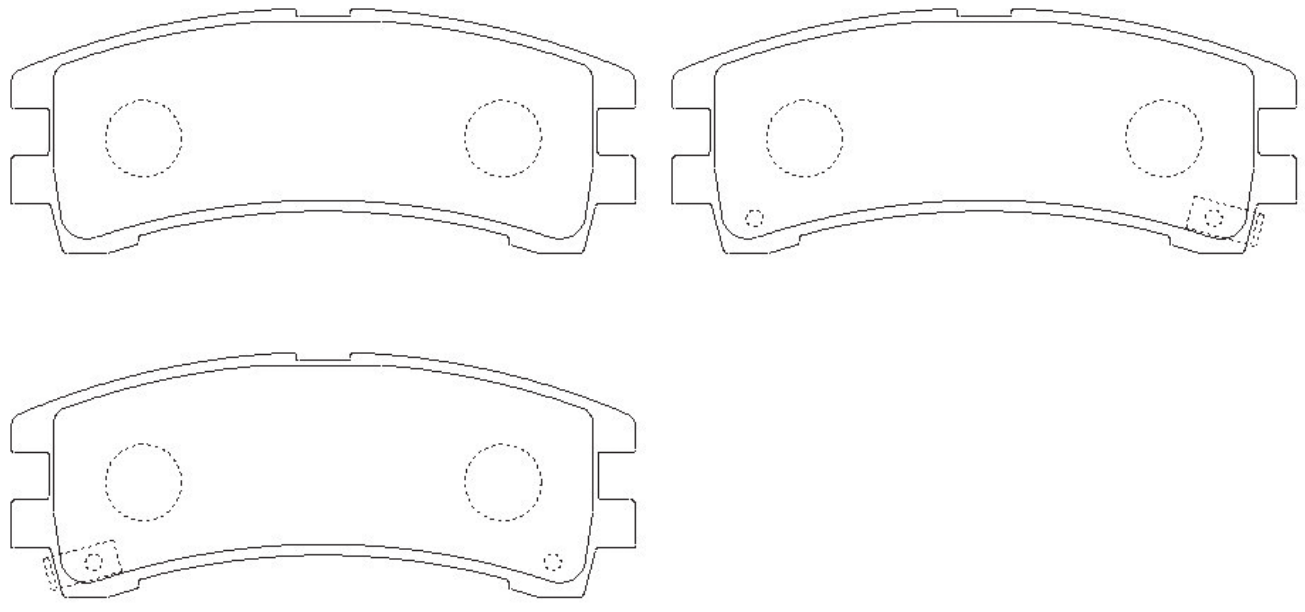

HN-305						108.6	49.8	14.8	AN-329WK
									D7023M-02

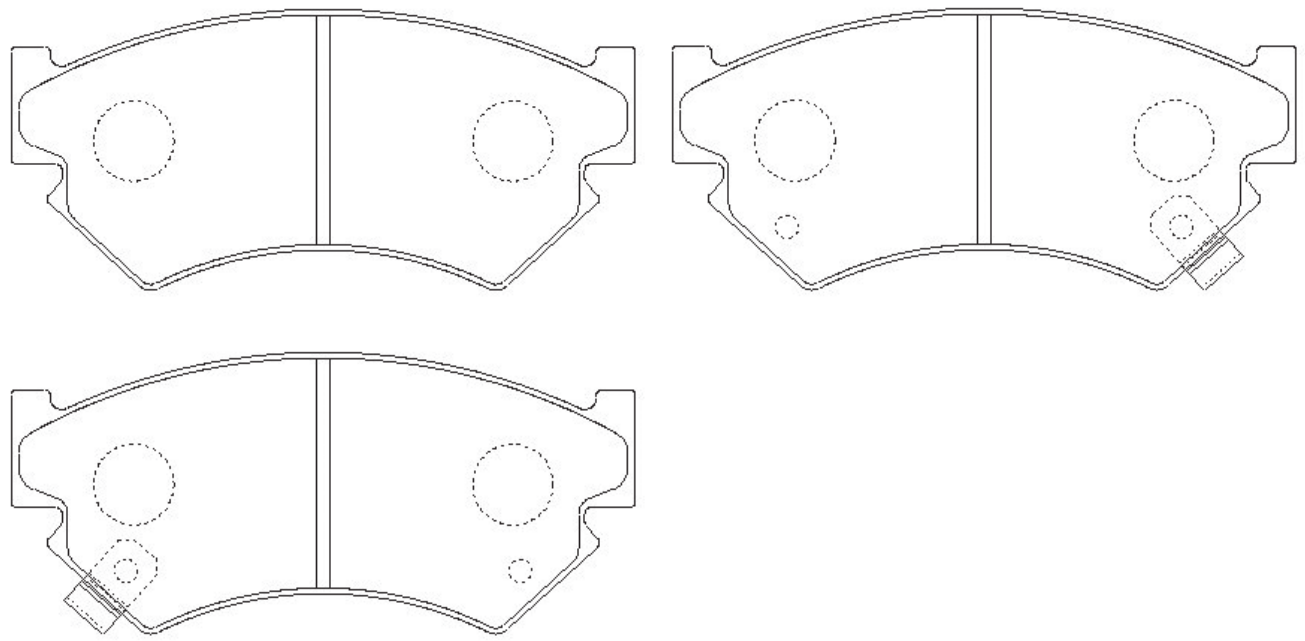

HN-308	170.0	54.5	17.8	AN-391K					
				D1177-02					

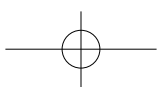
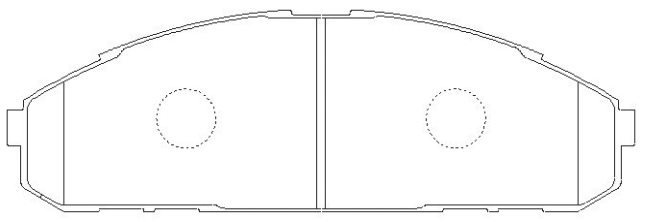

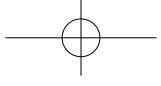

HN-No.	W	H	T	AKNo.	HN-No.	W	H	T	AKNo.
				MKNo.					MKNo.

HN-309				151.0	48.5	16.8	AN-382WK
							D1173M-02

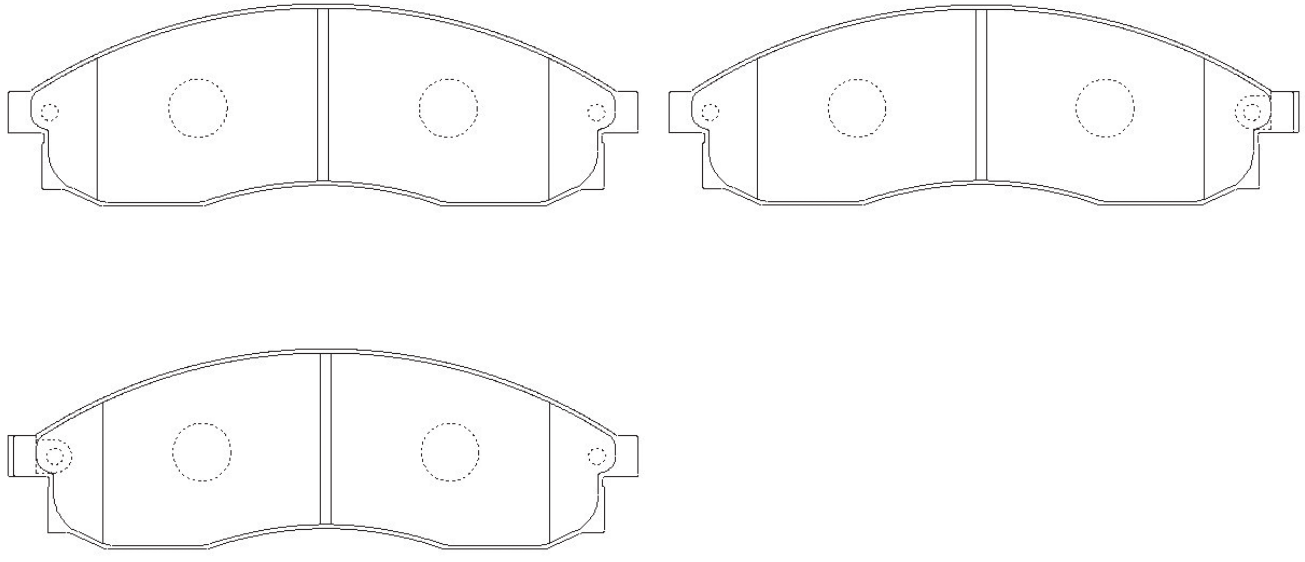

HN-311				100.0	45.0	15.0	AN-365K
				94.7	42.0	15.6	D6052-02

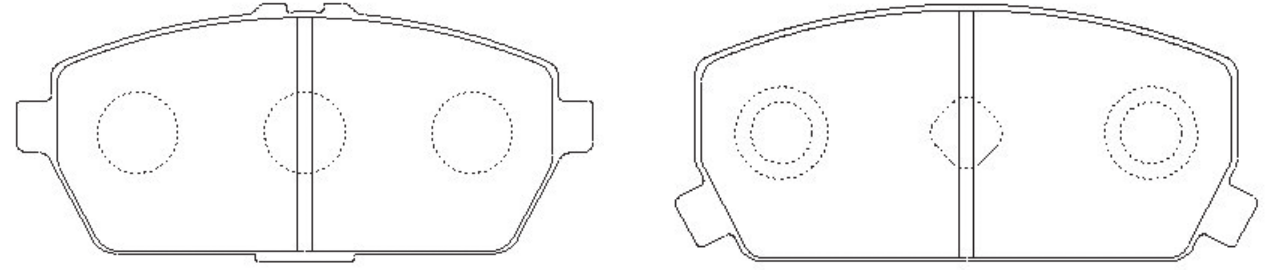

HN-312	96.4	44.5	14.4	A-290K
				D6037-02

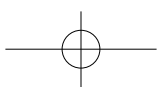
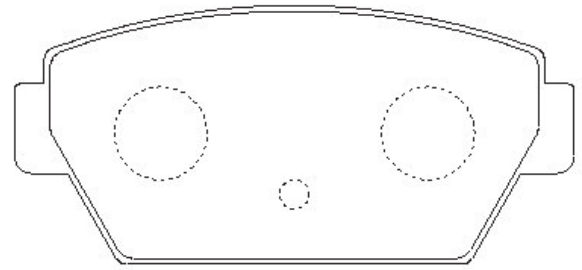

HN-No.	W	H	T	AKNo.	HN-No.	W	H	T	AKNo.
				MKNo.					MKNo.
HN-314						98.8	37.5	14.3	AN-380WK
									D6067M-02

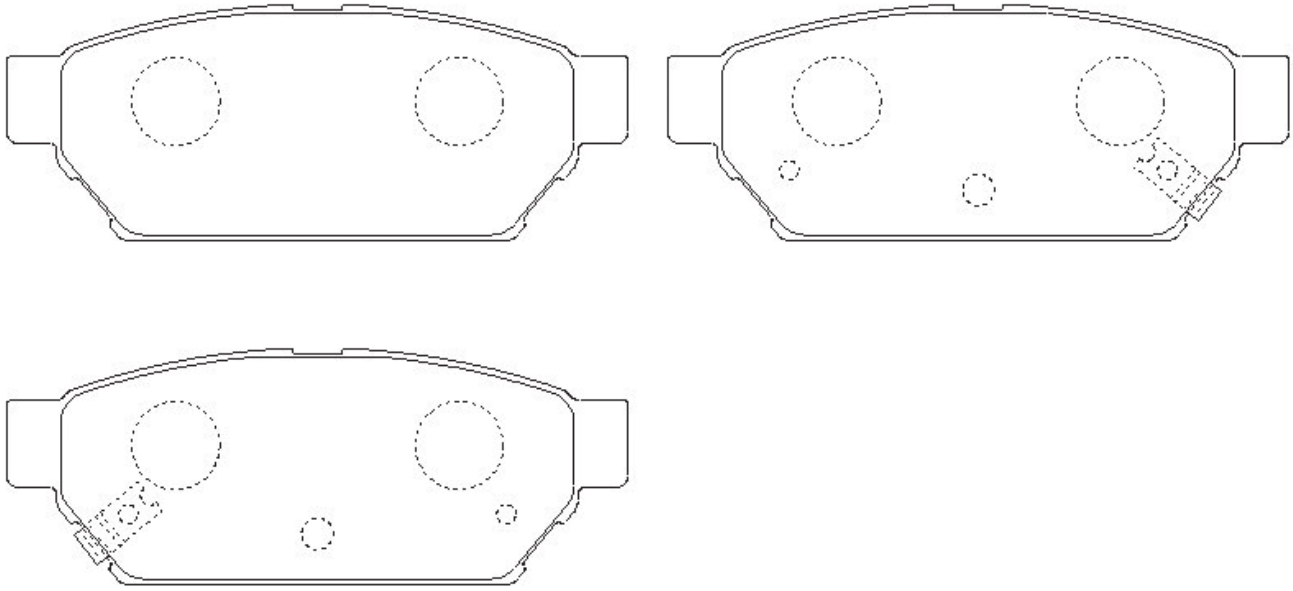

HN-315				112.0	39.0	14.0	AN-412K
				98.0	39.0	14.0	D7031-02

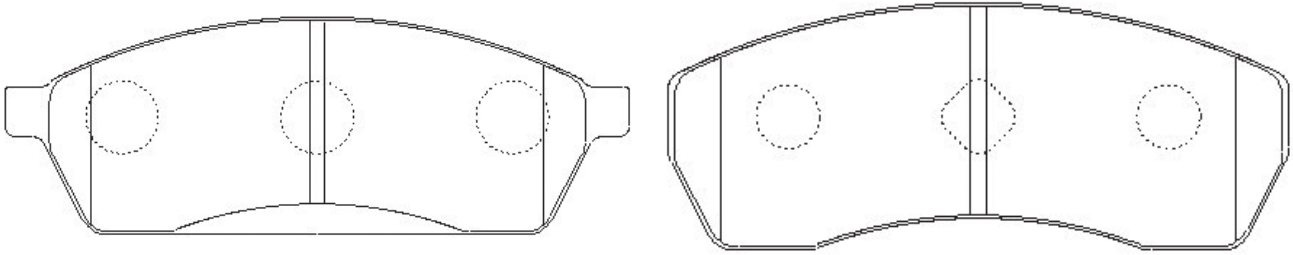

HN-316				107.1	67.5	14.7	AN-418WK
				107.1	80.0	14.7	D3077M-02

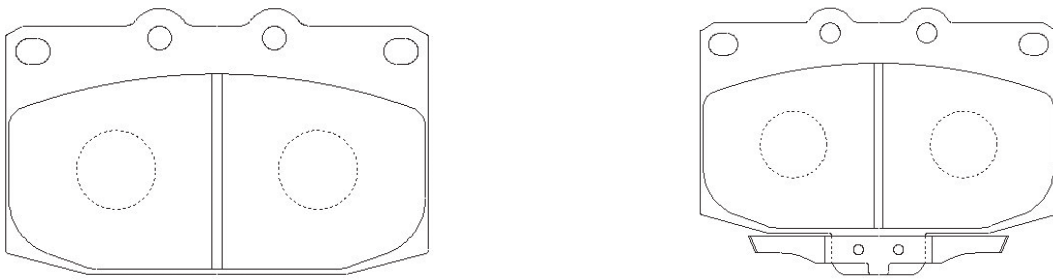

HN-No.	W	H	T	AKNo.	HN-No.	W	H	T	AKNo.
				MKNo.					MKNo.
HN-317						139.8	53.5	16.8	AN-402WK
									D1188M-02

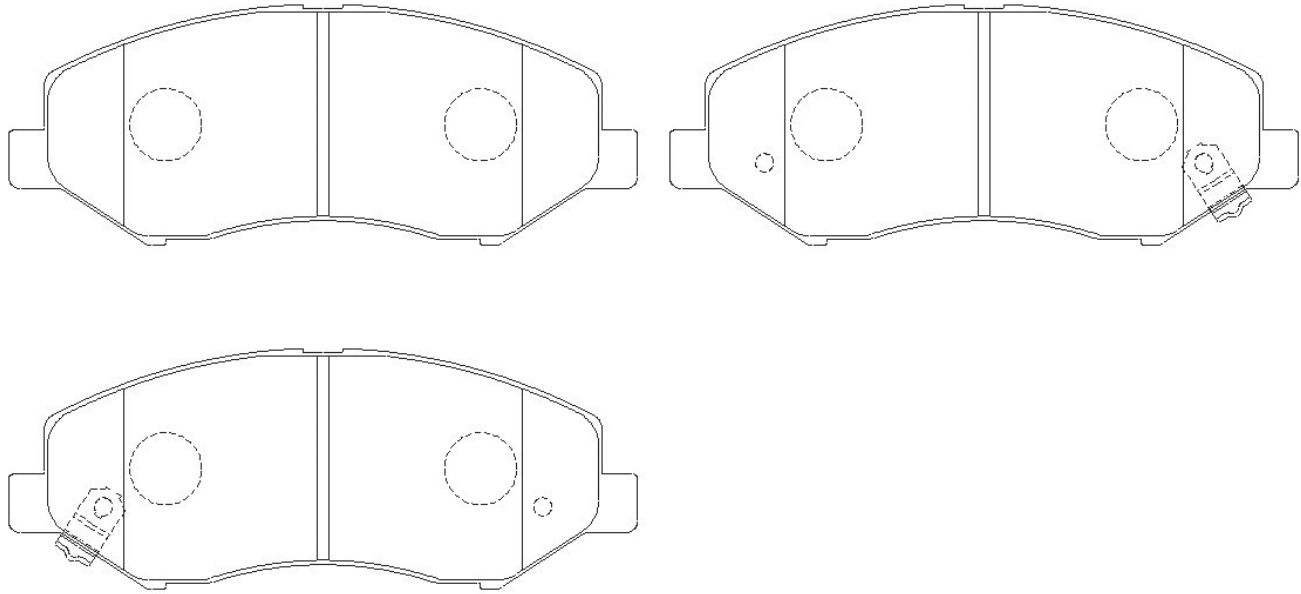

HN-320	160.6	49.5	16.8	AN-401K
				D1122-02

HN-321	107.6	42.5	14.9	AN-438WK
				D2114M-02

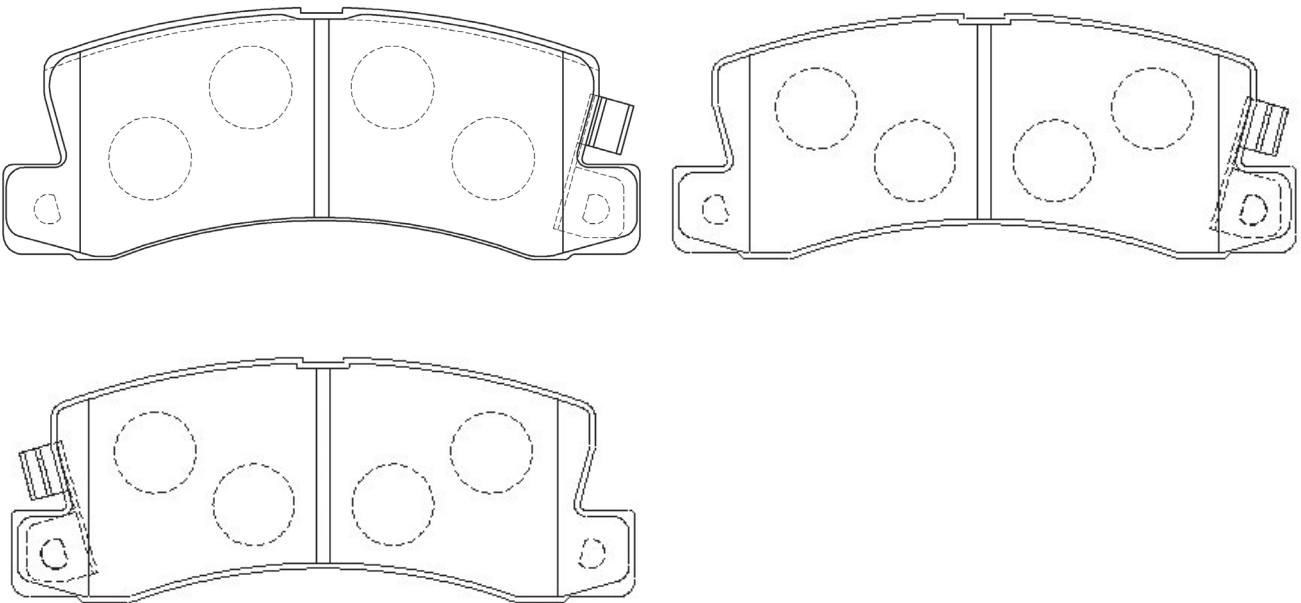

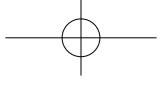

HN-No.	W	H	T	AKNo.	HN-No.	W	H	T	AKNo.
				MKNo.					MKNo.
HN-322						133.0	53.0	17.5	AN-394WK
									D2118M-02

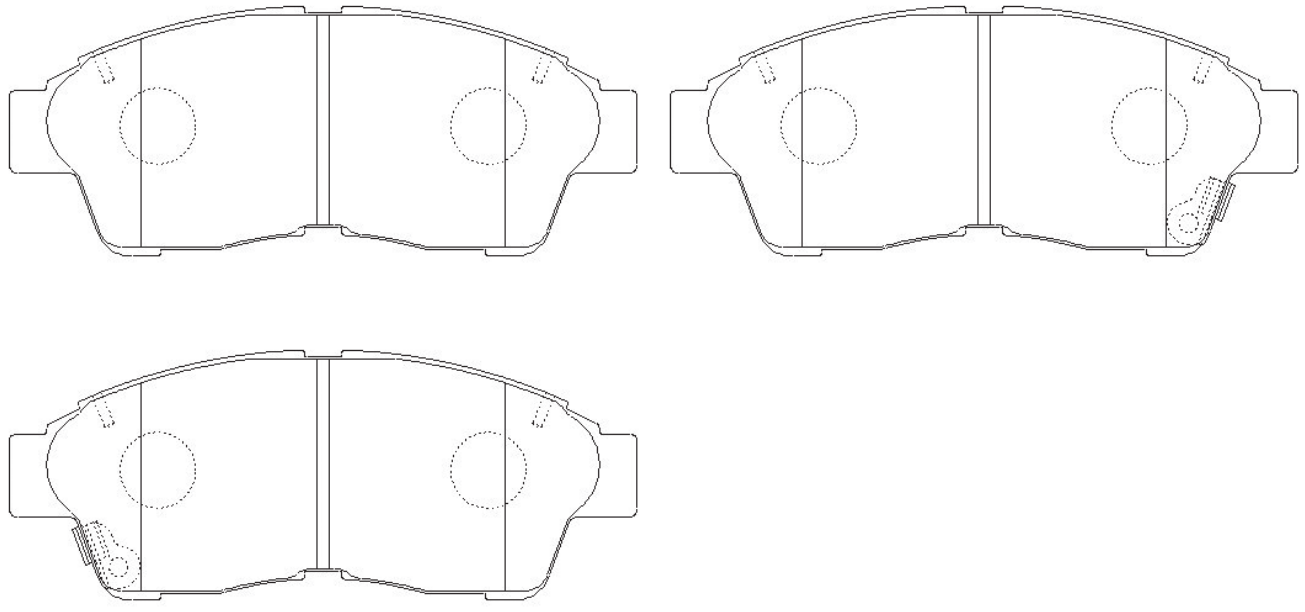

HN-323						106.0	38.2	17.5	AN-403WK
									D2131M-02

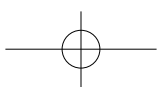
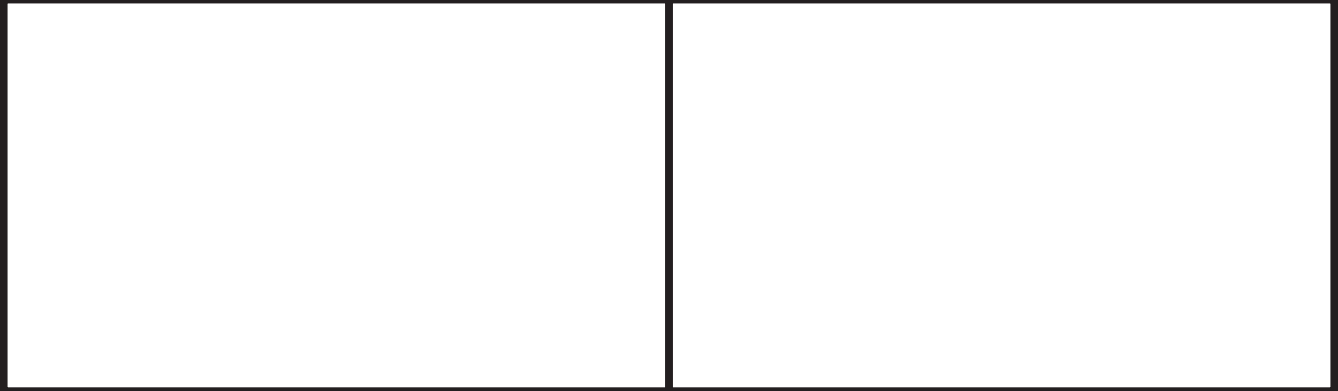
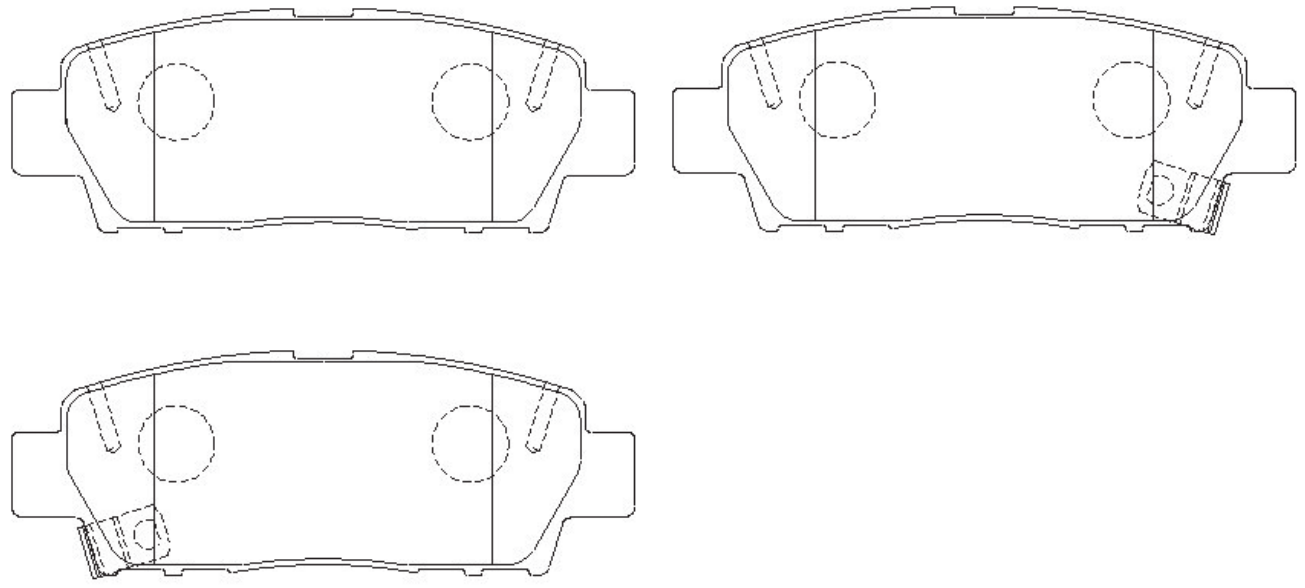

HN-No.	W	H	T	AKNo.	HN-No.	W	H	T	AKNo.
				MKNo.					MKNo.
HN-324						144.0	64.5	16.9	AN-413WK
									D2126M-02

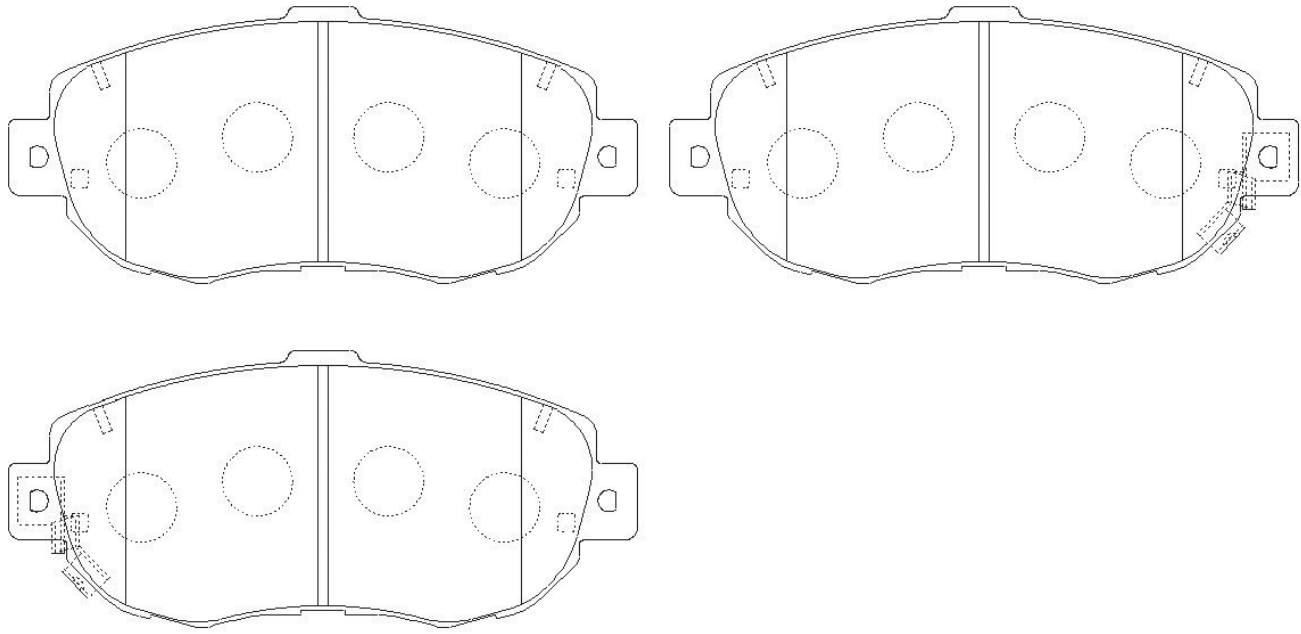

HN-325						144.0	64.5	16.9	AN-395K
									D2129-02

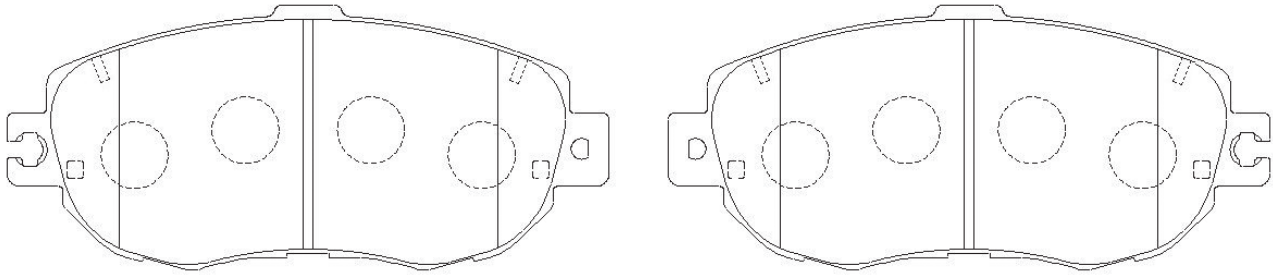

HN-326						122.1	41.0	15.5	AN-396K
									D2123-02

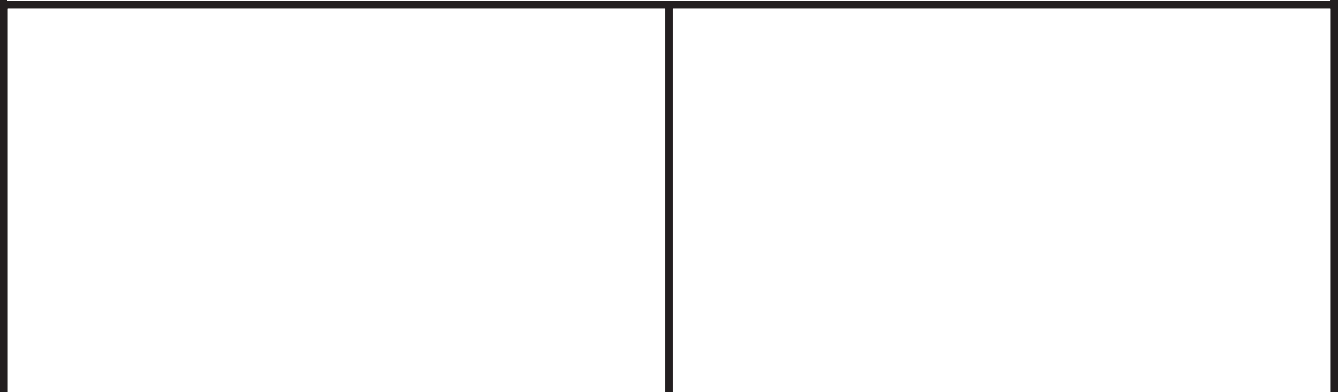
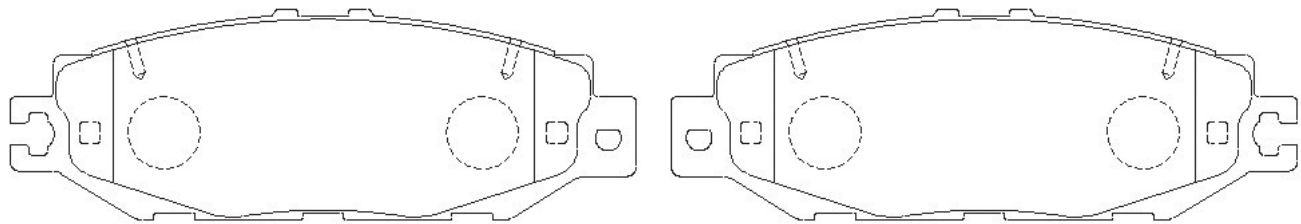

HN-No.	W	H	T	AKNo.	HN-No.	W	H	T	AKNo.
				MKNo.					MKNo.
HN-327									AN-404WK
									D2134M-02

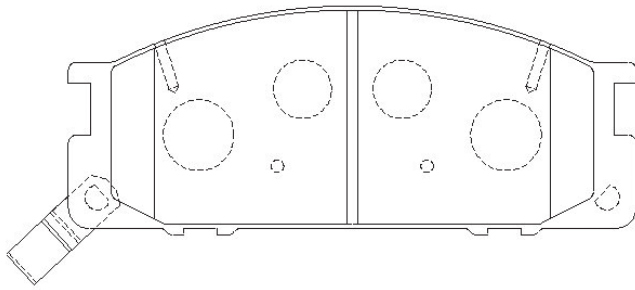
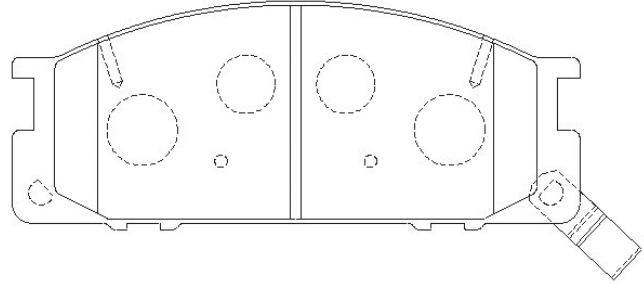
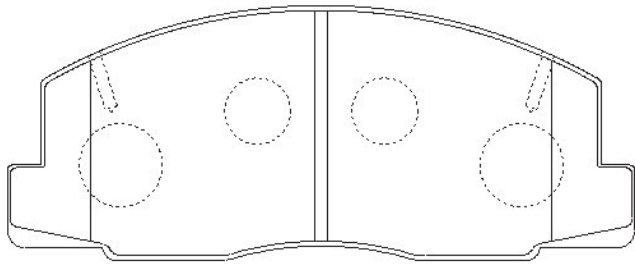

HN-328

126.7	55.0	15.2	AN-405WK
128.3	52.0	15.2	D2121M-02

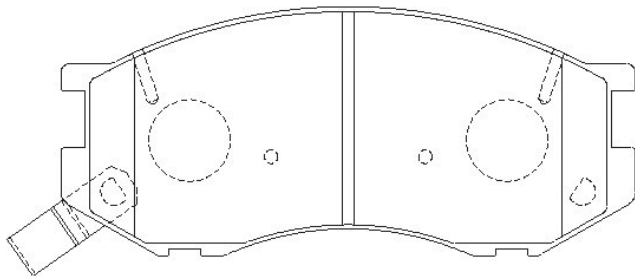
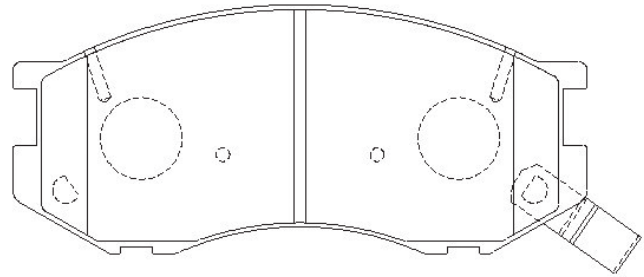
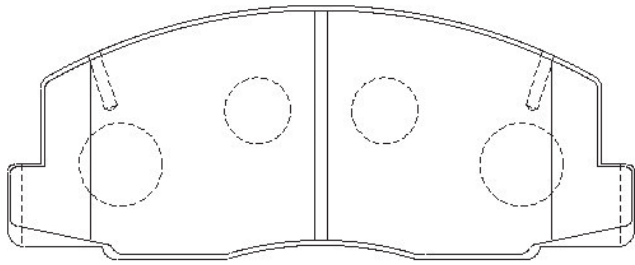

HN-329

166.3	62.2	19.8	AN-626WK
			D2148M-02

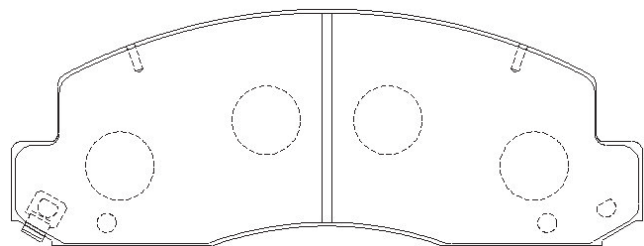
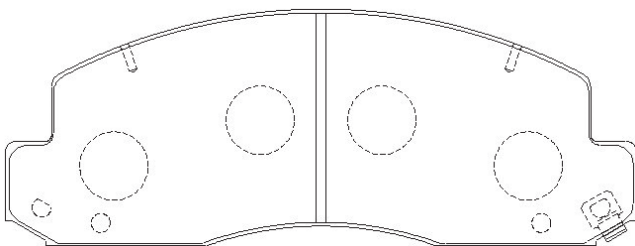

HN-No.	W	H	T	AKNo.	HN-No.	W	H	T	AKNo.
				MKNo.					MKNo.
HN-330						166.3	67.0	19.8	AN-628WK
									D2140M-02

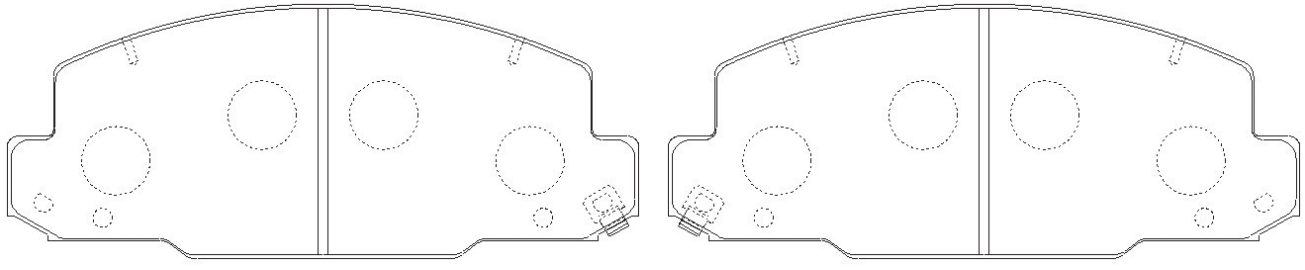

HN-331						129.8	55.8	15.8	AN-454WK
									D3089M-02

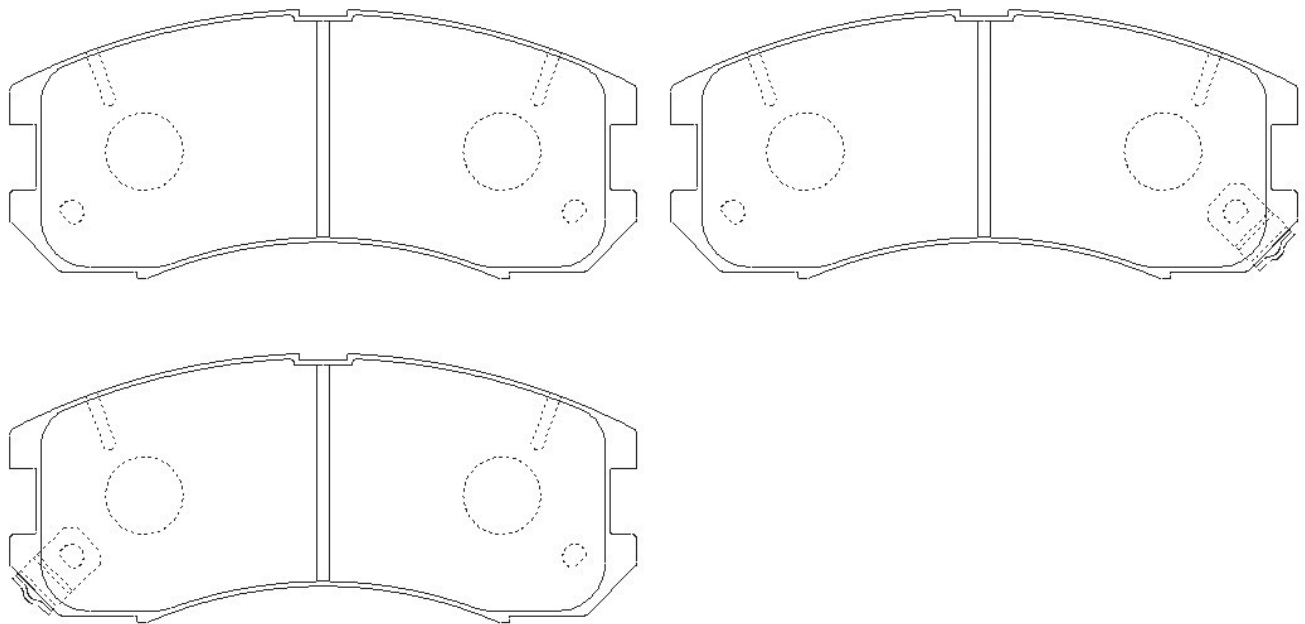

HN-332	139.1	57.9	15.8	AN-633K	HN-334	142.0	59.5	15.8	AN-423K
				D3088-02					D3098-02

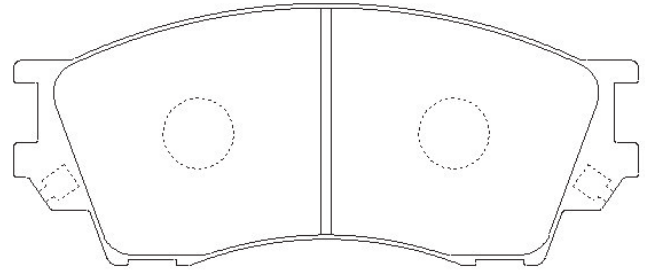
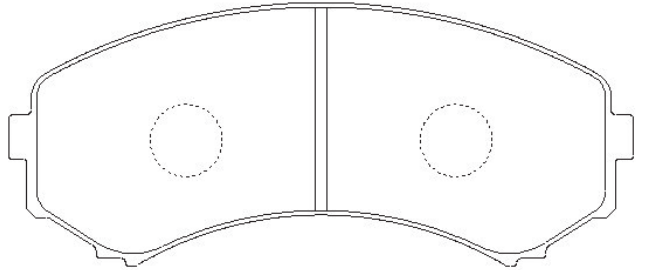

HN-335	117.1	42.5	14.8	AN-424K					
	117.1	42.5	13.8	D3100-02					

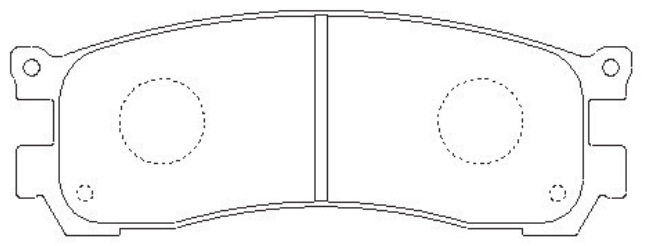

HN-No.	W	H	T	AKNo.	HN-No.	W	H	T	AKNo.
				MKNo.					MKNo.
HN-336						104.0	43.0	14.3	AN-416WK
									D5083M-02

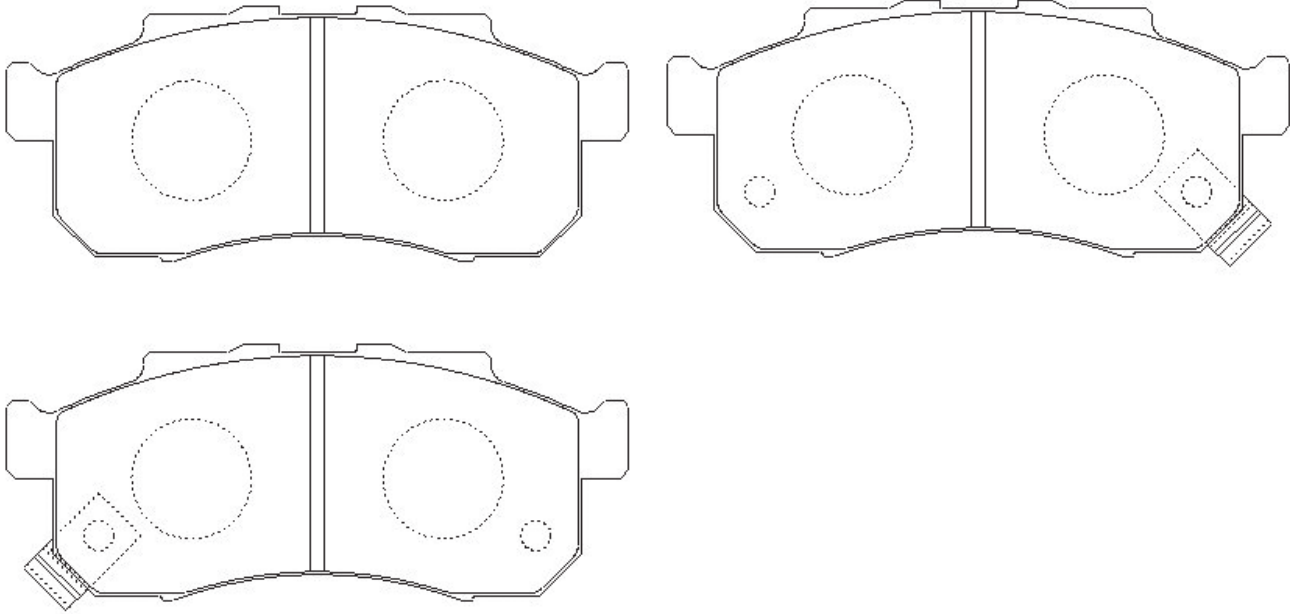

HN-337						129.0	54.5	16.3	AN-419WK
									D5088M-02

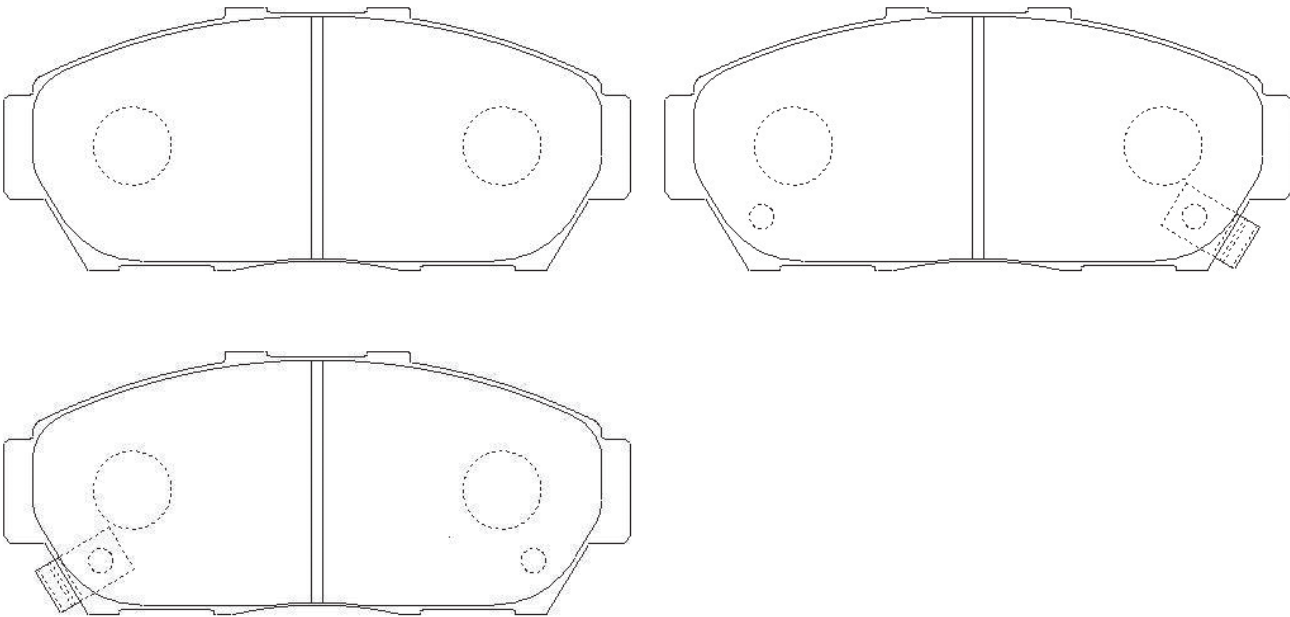

HN-339	105.0	43.5	12.3	AN-388K					
				D9022-02					

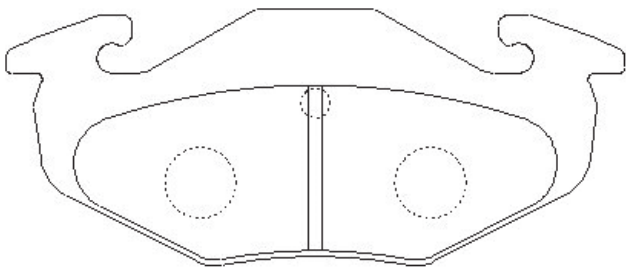

HN-No.	W	H	T	AKNo.	HN-No.	W	H	T	AKNo.
				MKNo.					MKNo.
HN-340						127.6	45.4	15.4	AN-414WK
									D0027M-02

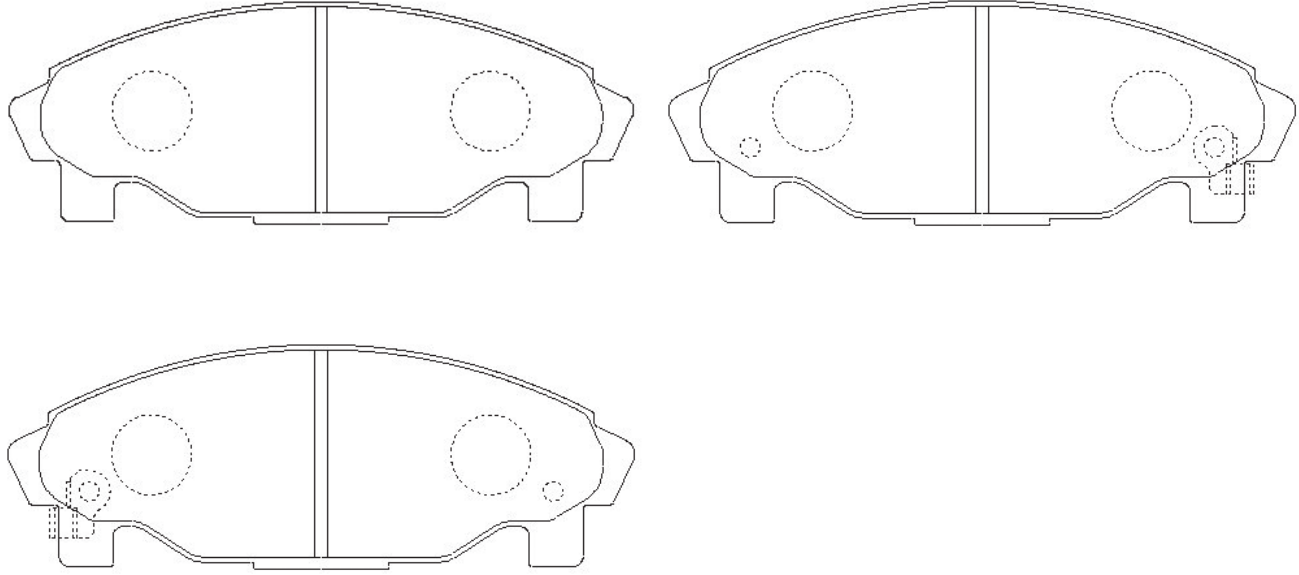

HN-341				106.0		41.5	15.0	AN-444WK
								D0030M-02

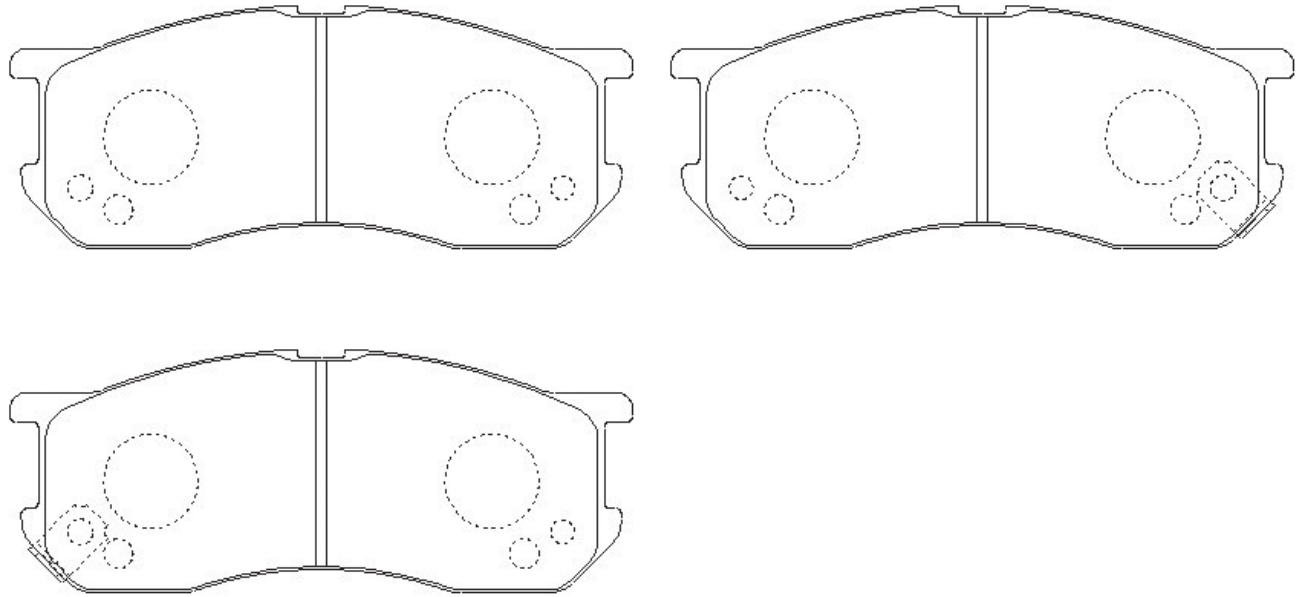

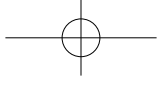

HN-No.	W	H	T	AKNo.	HN-No.	W	H	T	AKNo.
				MKNo.					MKNo.

HN-343						160.6	49.5	16.8	A-SM212WK
									D1063M-TX

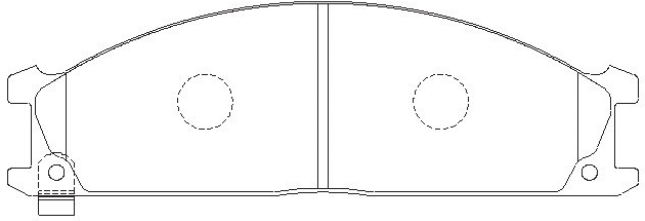
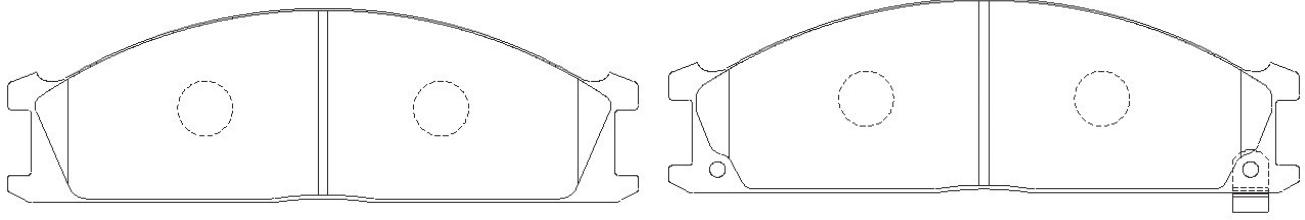

HN-344						160.6	49.5	15.8	AN-439WK
									D1194M-02

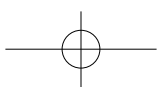
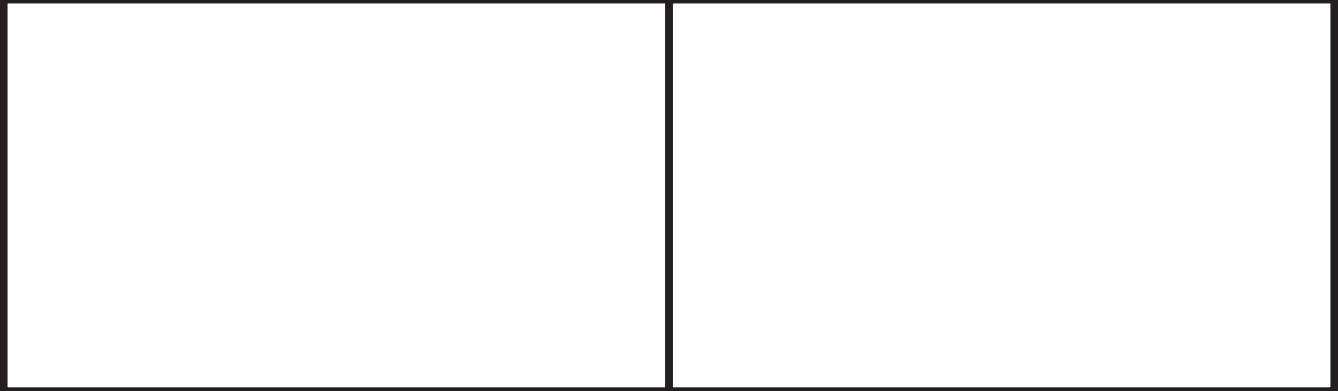
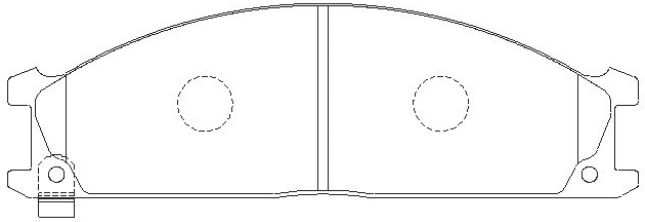
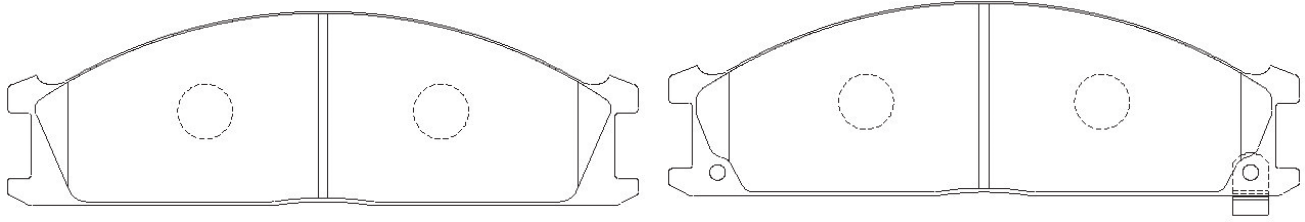

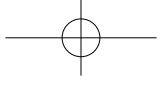

HN-No.	W	H	T	AKNo.	HN-No.	W	H	T	AKNo.
				MKNo.					MKNo.

HN-345									AN-393WK
				133.0					56.2

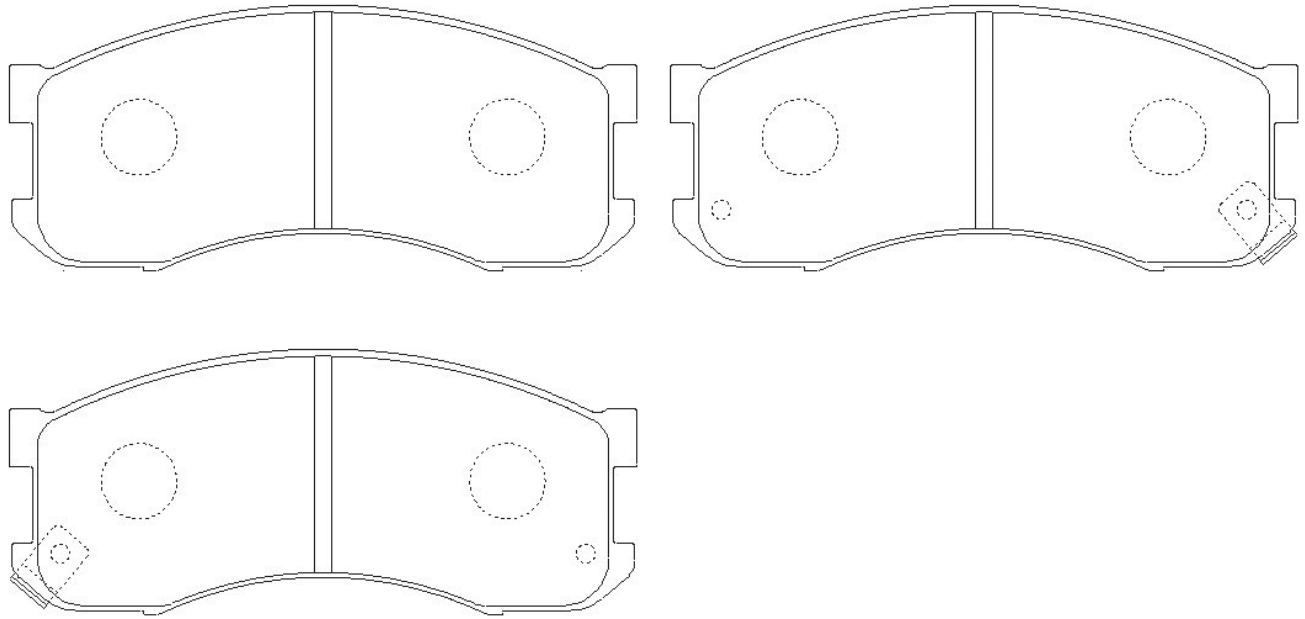

HN-346									AN-428K
				133.0					56.2

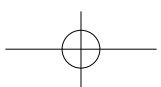
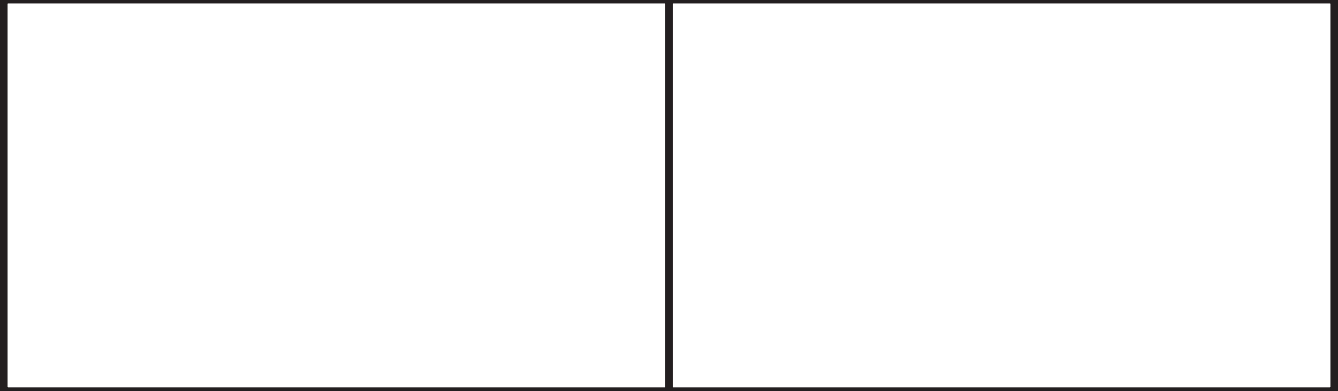
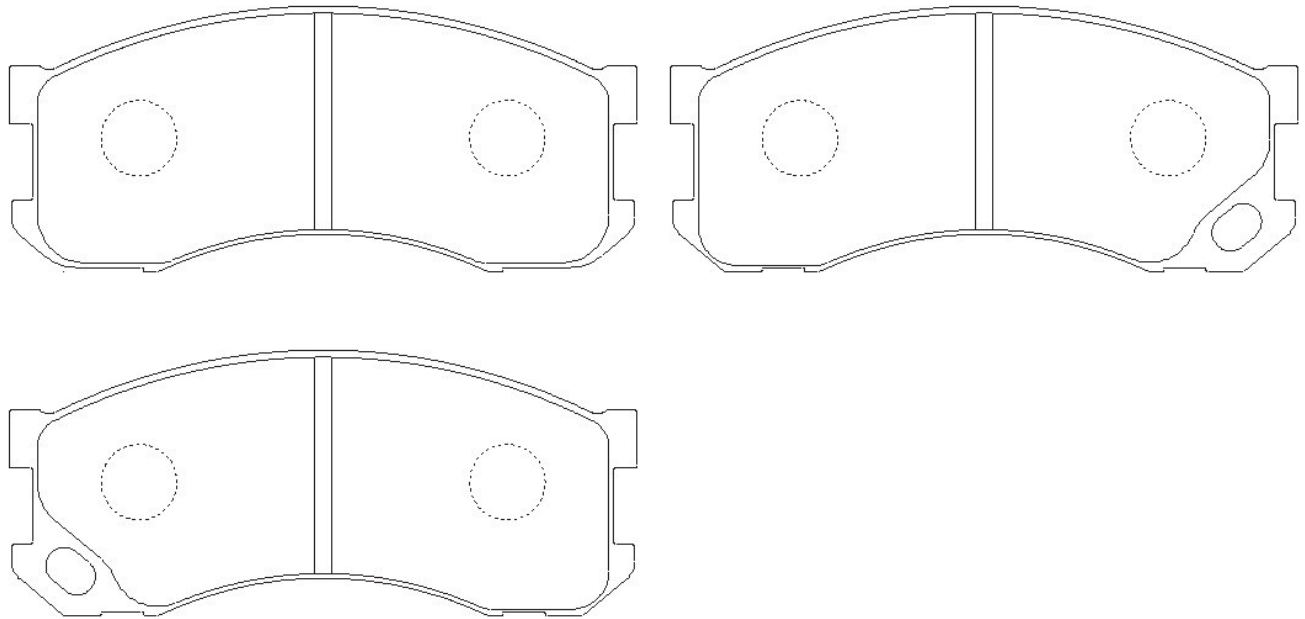

HN-No.	W	H	T	AKNo.	HN-No.	W	H	T	AKNo.
				MKNo.					MKNo.
HN-347						140.1	51.5	17.8	AN-425K
									D6071-02

※1pad for R/L w/sensor holes, 2pads w/o sensor holes

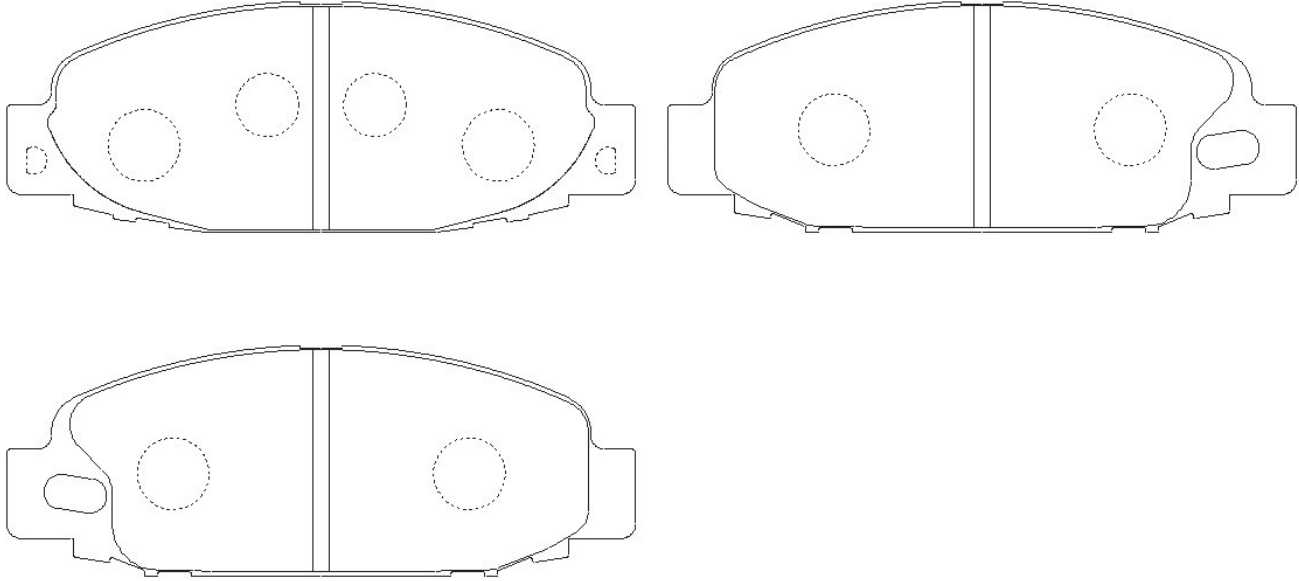

HN-348						133.1	53.4	17.2	AN-426K
									D6060-02

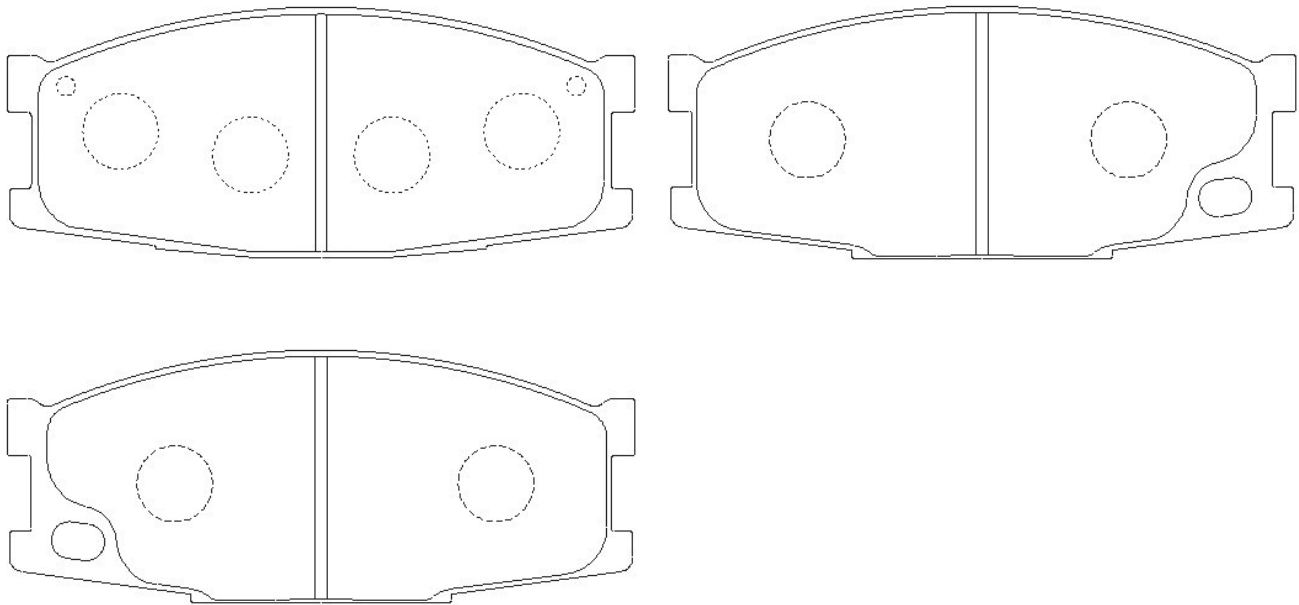

HN-No.	W	H	T	AKNo.	HN-No.	W	H	T	AKNo.
				MKNo.					MKNo.
HN-349									AN-427K
									D6062-02

※1pad for R/L w/sensor holes, 6pads w/o sensor holes

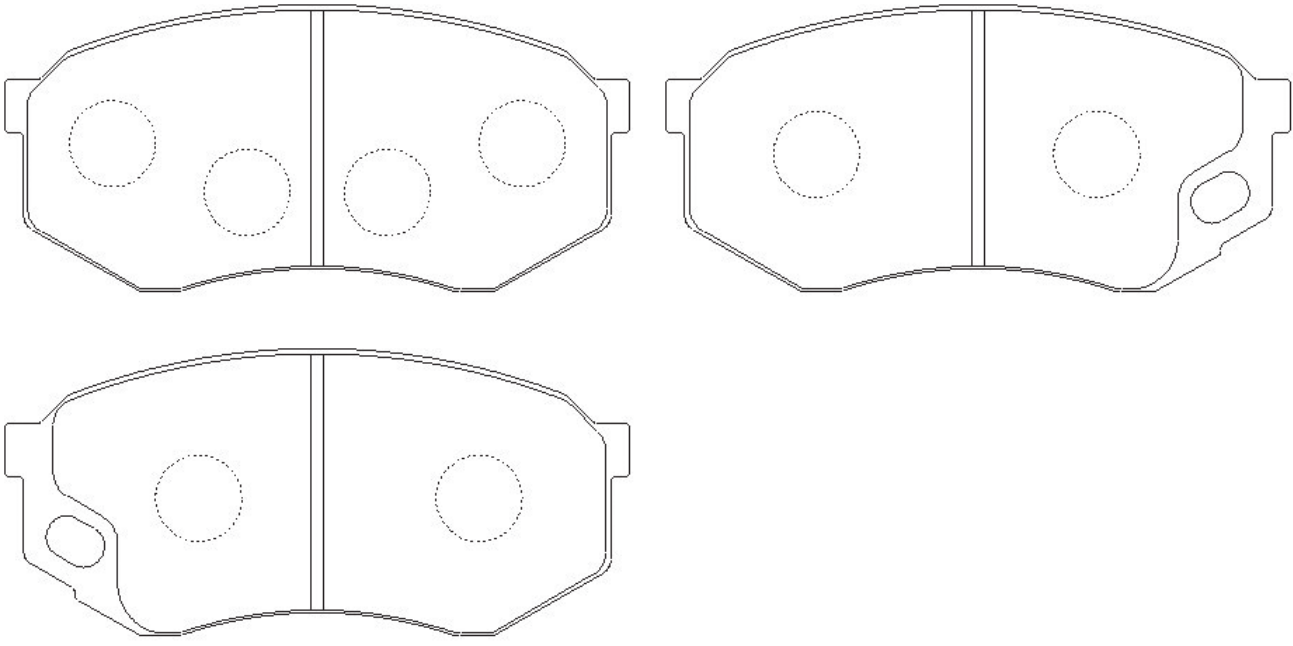

HN-351				119.3	76.4	14.8	AN-406WK
				119.3	71.9	14.8	D2117M-02

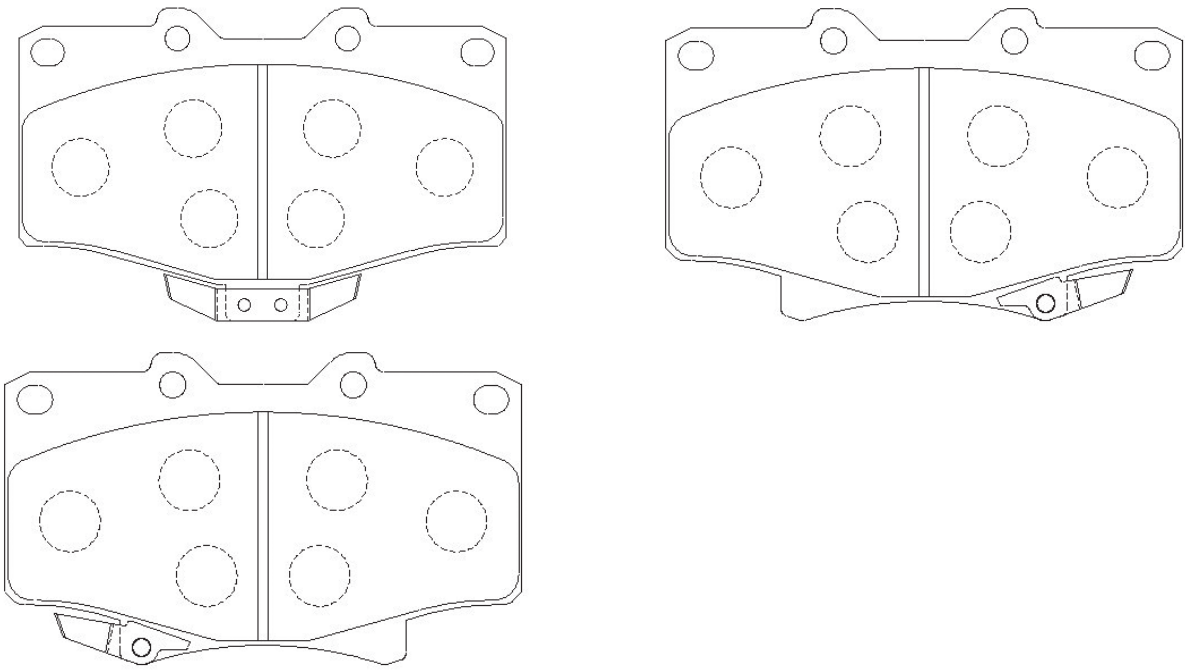

HN-352				119.3	74.7	14.8	AN-399WK
				119.3	65.2	14.8	D6075M-02

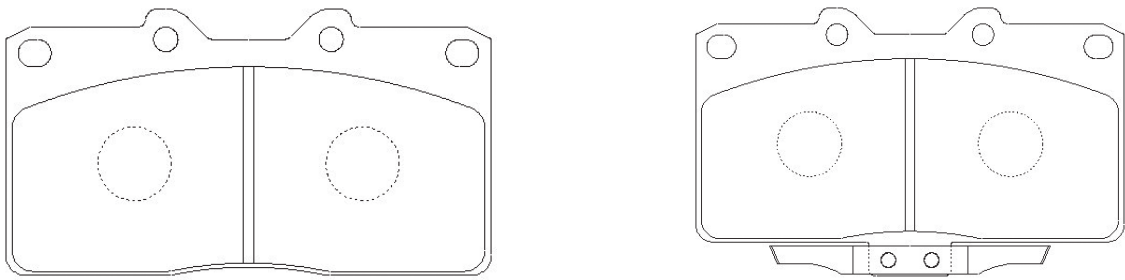

HN-No.	W	H	T	AKNo.	HN-No.	W	H	T	AKNo.
				MKNo.					MKNo.
HN-353	101.5	41.7	11.8	AN-415K	HN-355	110.1	44.0	14.3	AN-443K
				D3031-02					

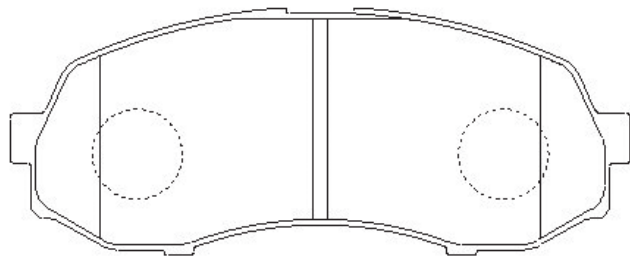
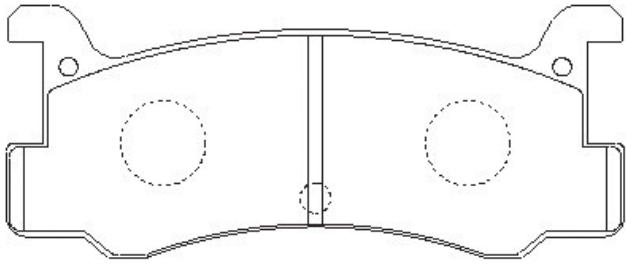

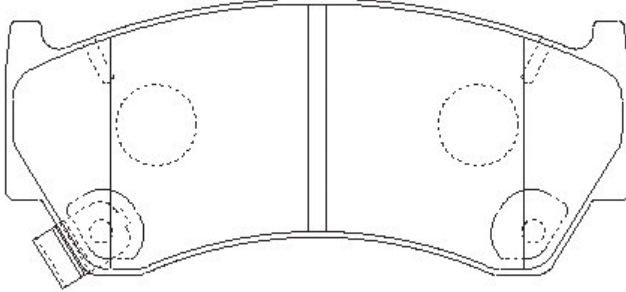
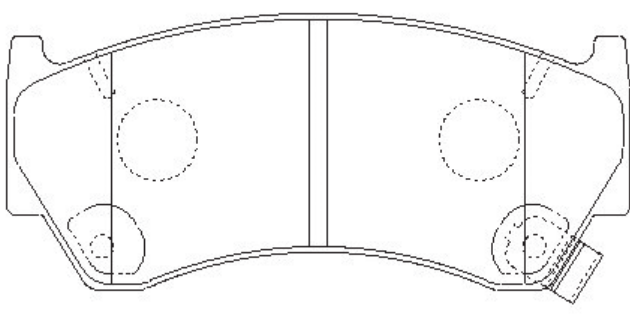
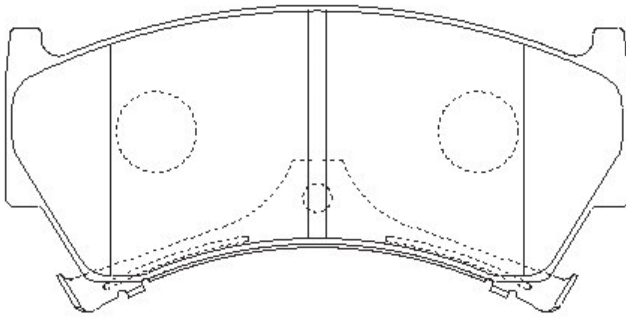

HN-356					108.5	48.0	15.8		AN-431WK D1202M-02
--------	--	--	--	--	-------	------	------	--	-----------------------

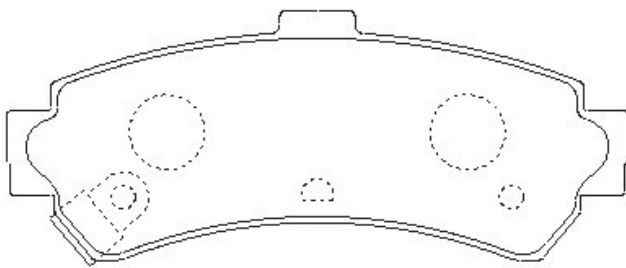
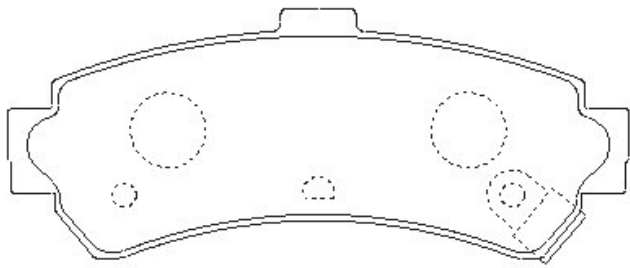
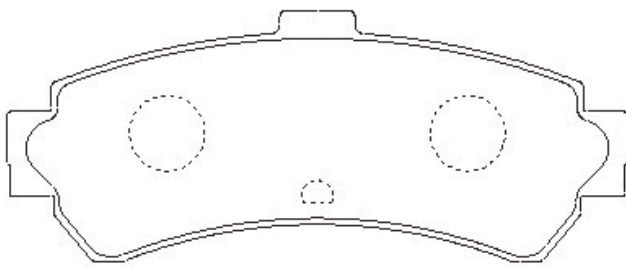

HN-357					99.4	40.0	14.8		AN-432WK D1205M-02
--------	--	--	--	--	------	------	------	--	-----------------------

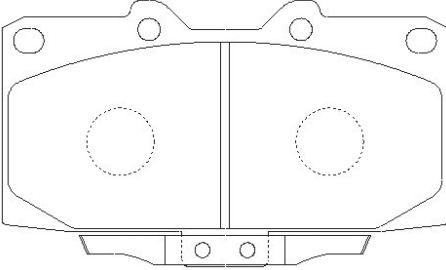
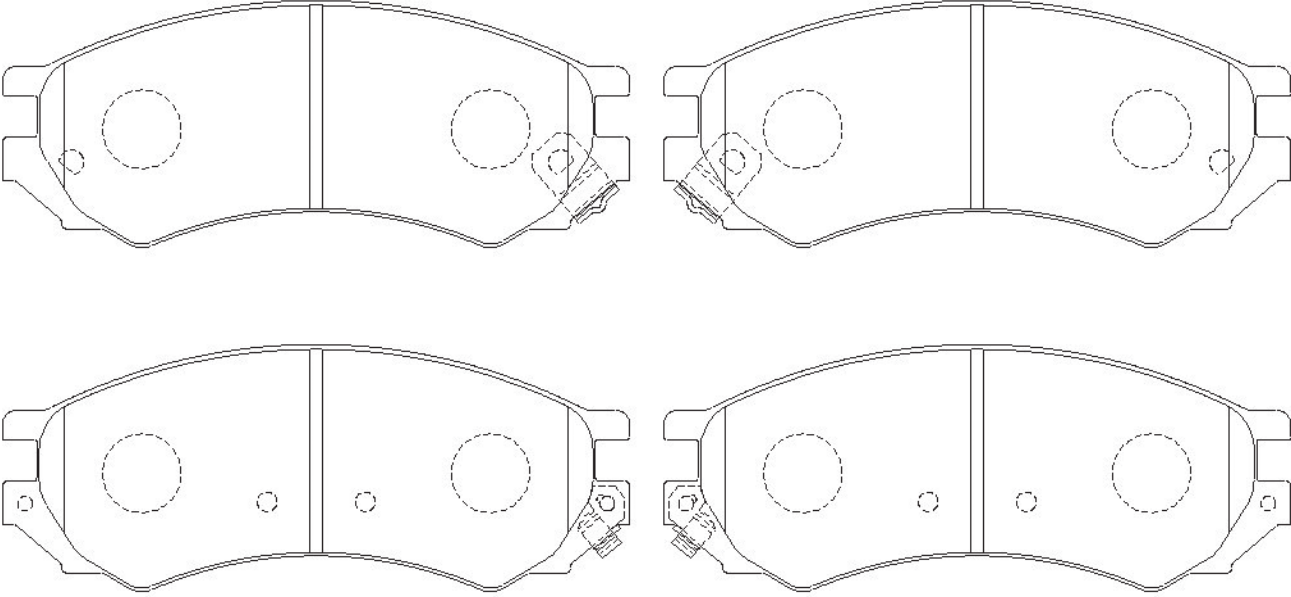

HN-No.	W	H	T	AKNo.	HN-No.	W	H	T	AKNo.
				MKNo.					MKNo.
HN-358	119.2	69.9	14.3	AN-430WK					
				D1199M-02					
									
HN-359									AN-440WK
									D1197M-02
									
HN-360									AN-435WK
									D2136M-02
									
HN-361									AN-436WK
									D2146M-02
									

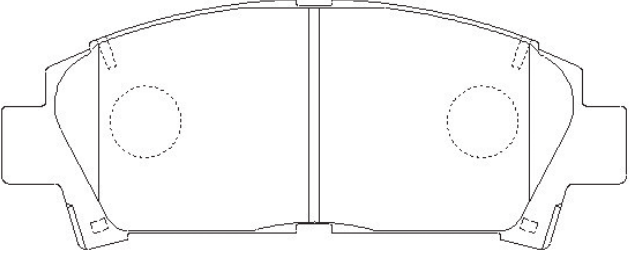
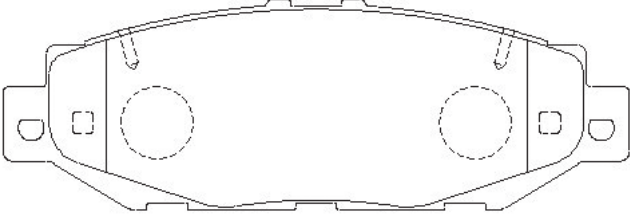
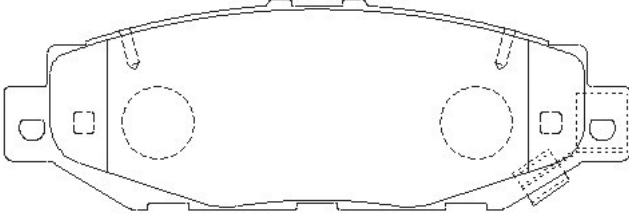
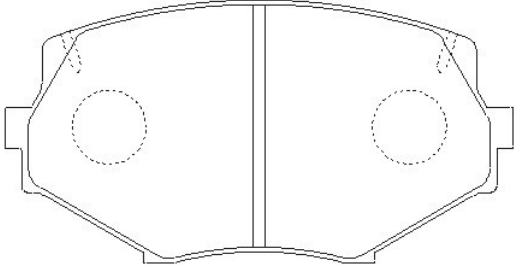
HN-No.	W	H	T	AKNo.	HN-No.	W	H	T	AKNo.
				MKNo.					MKNo.
HN-362	141.0	56.0	17.5	AN-437K					
				D2145-02					
									
HN-363					122.1	41.0	15.5		AN-398WK
									D2125M-02
									
HN-364	110.1	57.0	12.8	AN-461K					
				D3093-02					
									

HN-No.	W	H	T	AKNo.	HN-No.	W	H	T	AKNo.
				MKNo.					MKNo.
HN-365						102.0	43.2	12.5	AN-466WK
									D3094M-02

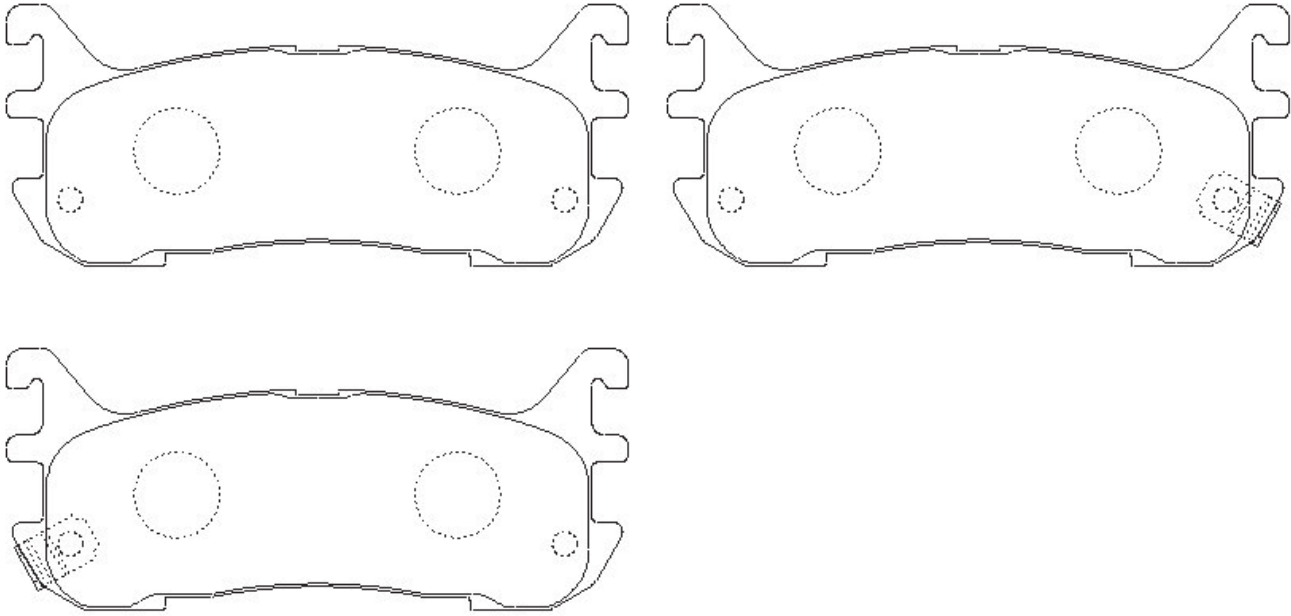

HN-367				114.8		47.7	15.8	AN-272WK
								D1066M-02

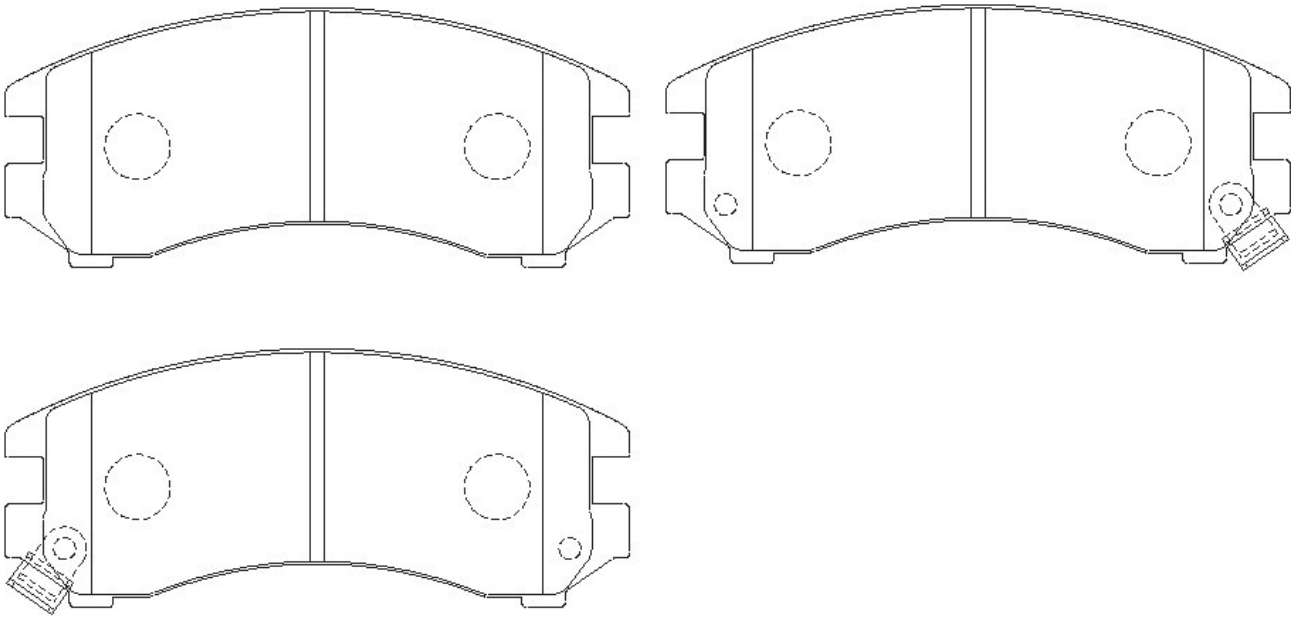

HN-368				177.4		68.5	19.8	AN-381WK
								D1170M-02

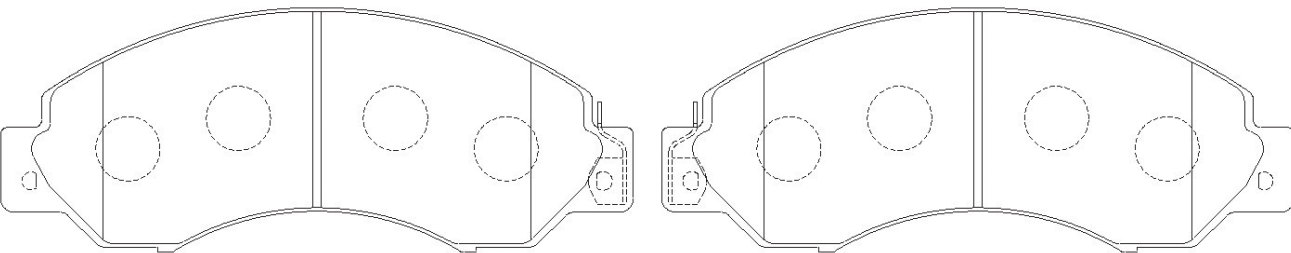

HN-No.	W	H	T	AKNo.	HN-No.	W	H	T	AKNo.
				MKNo.					MKNo.
HN-369						137.8	55.0	15.5	AN-433WK
									D6081-02

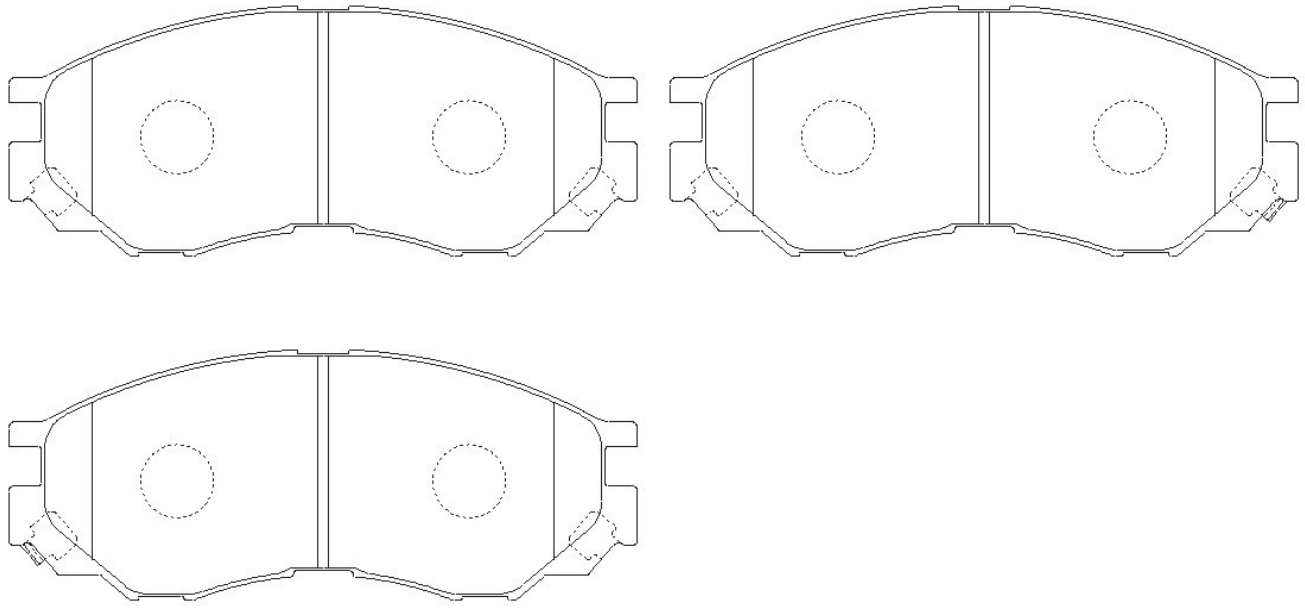

HN-370				115.6		75.4	16.8	AN-445K
								D2154-02

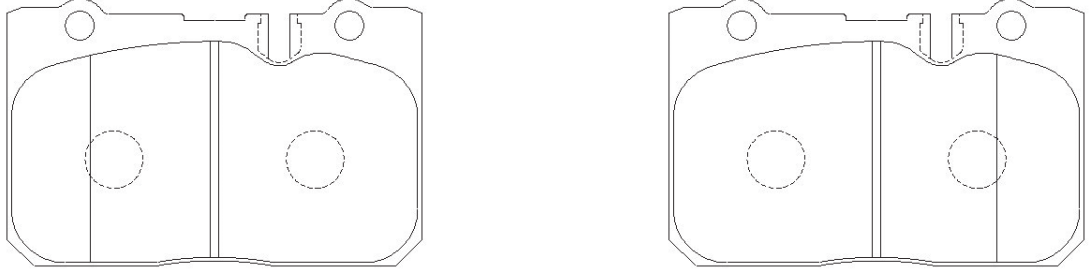

HN-371				127.8		50.5	18.8	AN-441WK
								D1200M-02

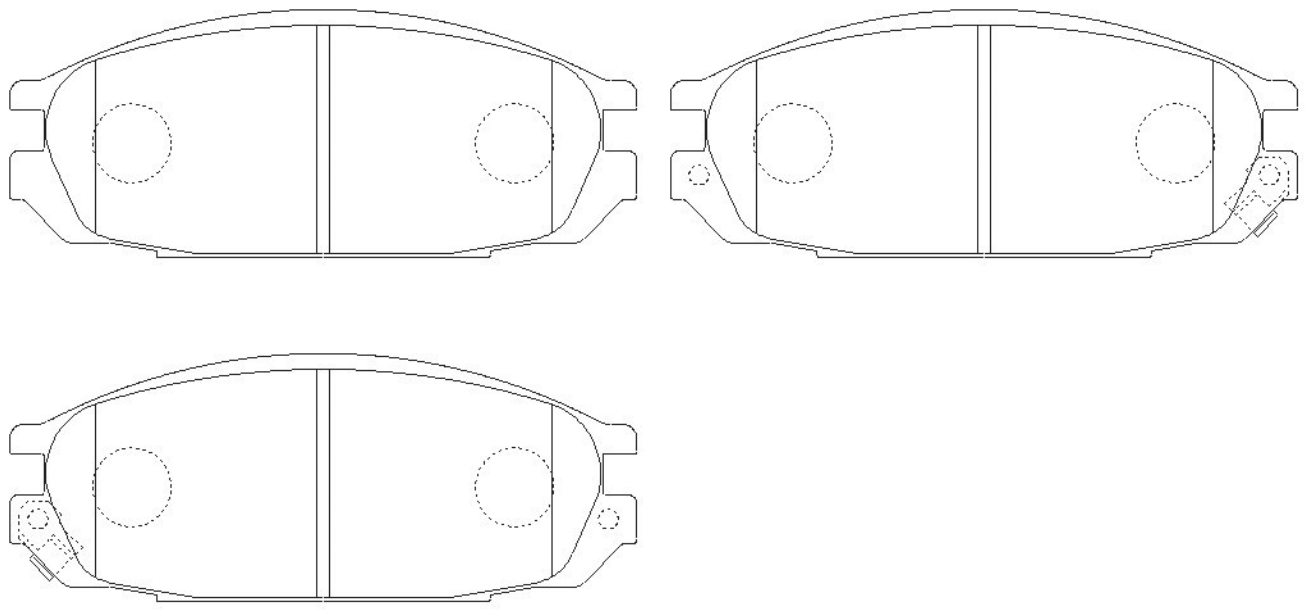

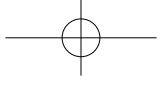

HN-No.	W	H	T	AKNo.	HN-No.	W	H	T	AKNo.
				MKNo.					MKNo.
HN-372						96.4	44.5	14.4	AN-442WK
									D6079M-02

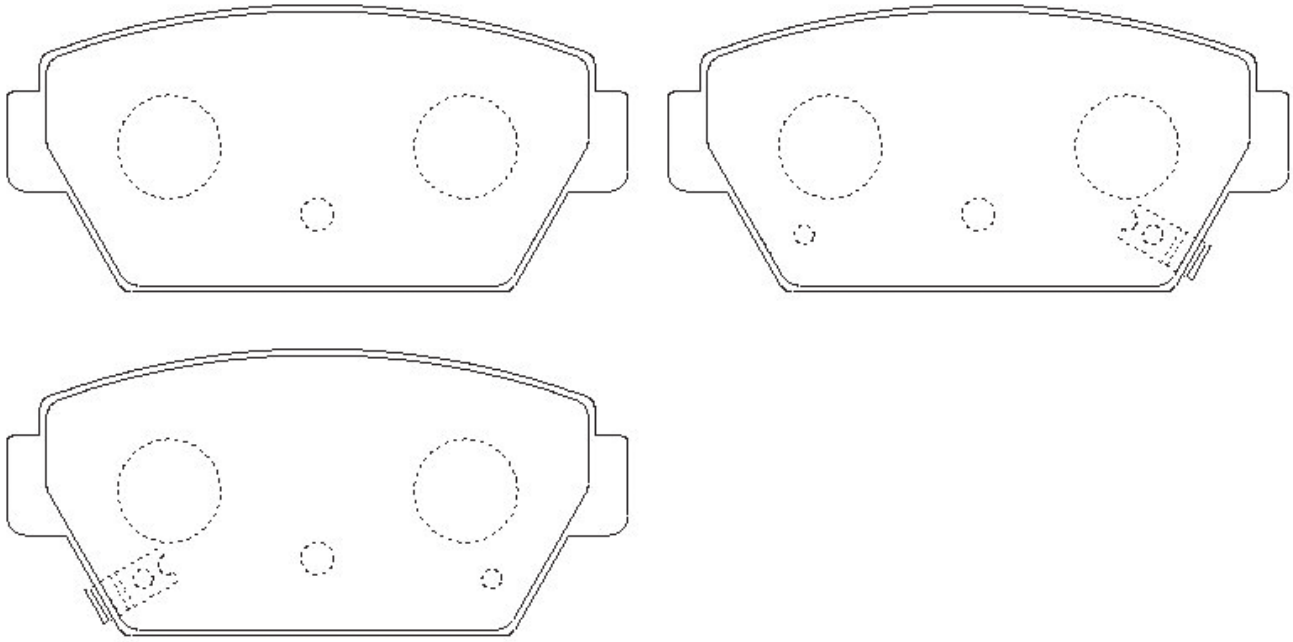

HN-373	98.8	37.5	14.3	AN-434K
				D6078-02

HN-374				137.8	52.5	18.3	AN-455WK
							D5080M-02

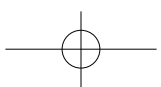
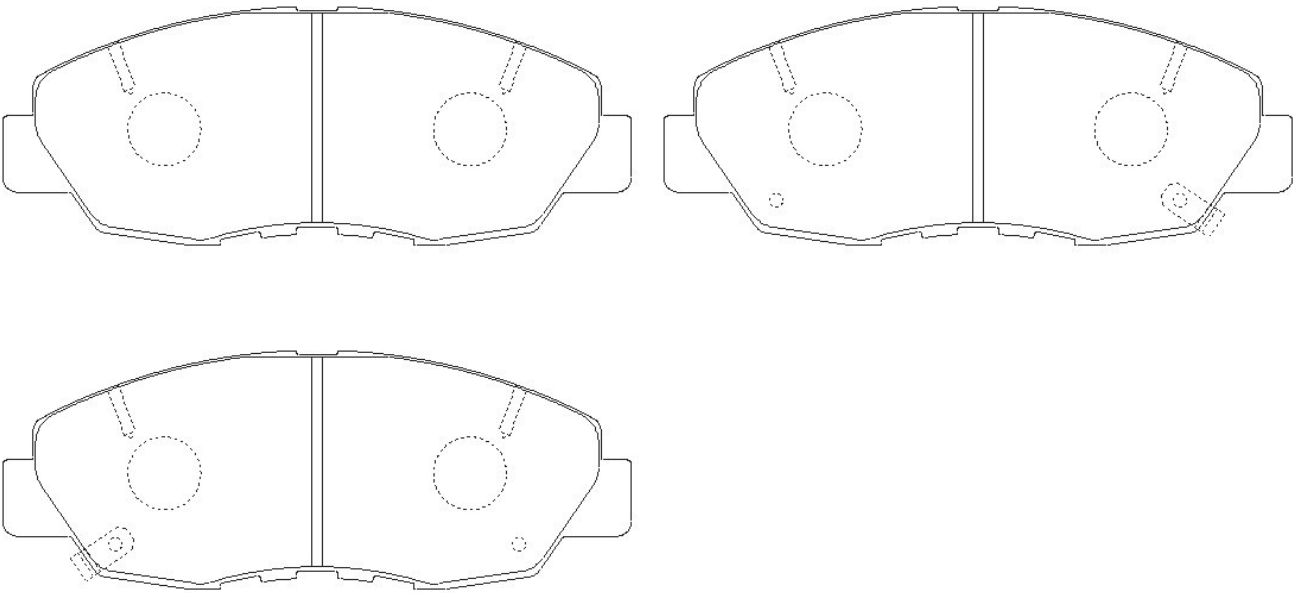

HN-No.	W	H	T	AKNo.	HN-No.	W	H	T	AKNo.
				MKNo.					MKNo.
HN-375						108.5	48.0	16.3	AN-471WK
									D1208M-02

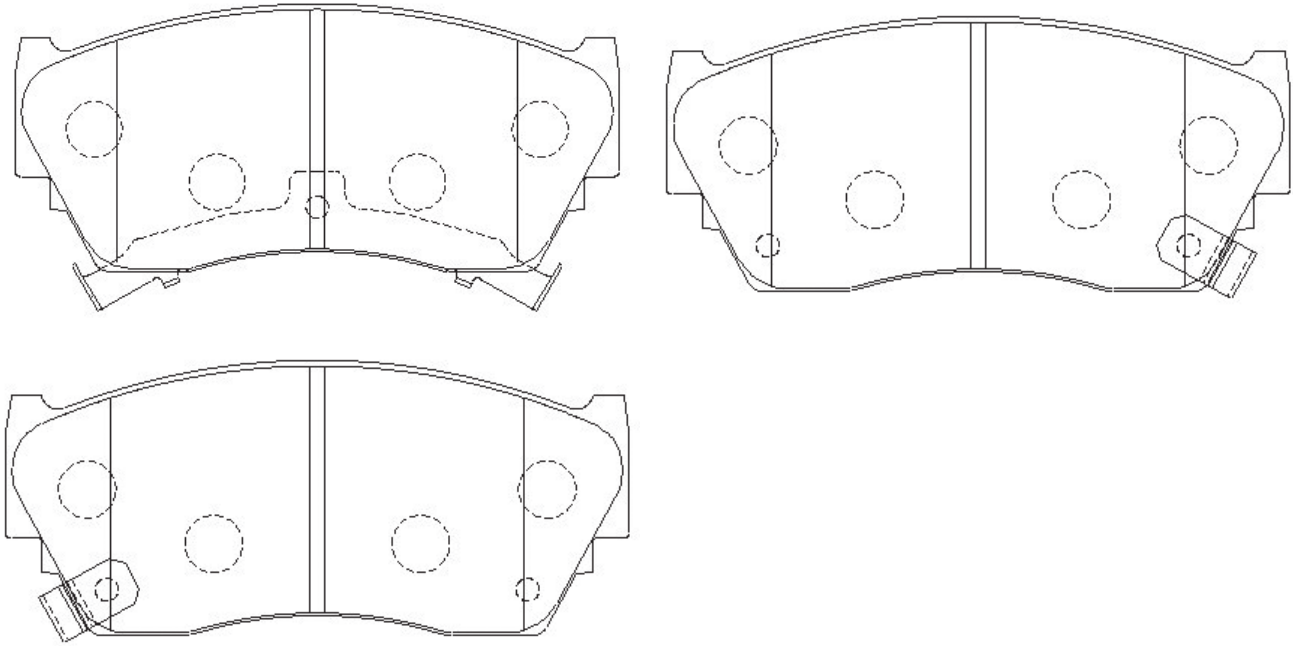

HN-376	139.2	60.1	15.8	AN-452K
				D3099-02

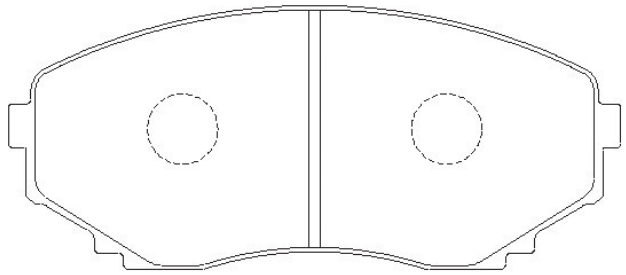

HN-377				85.3	42.5	14.3	AN-422WK
							D1099M-02

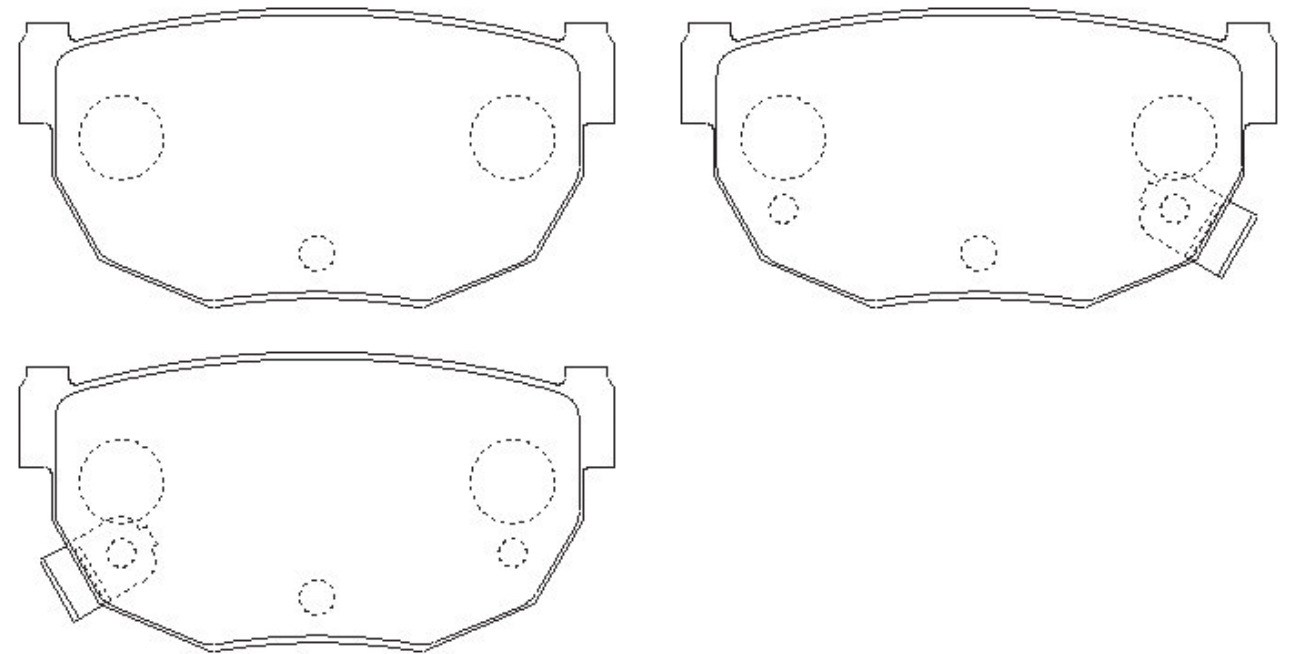

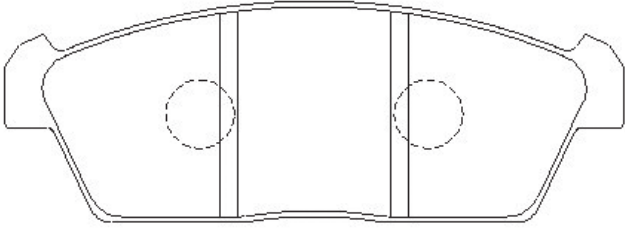
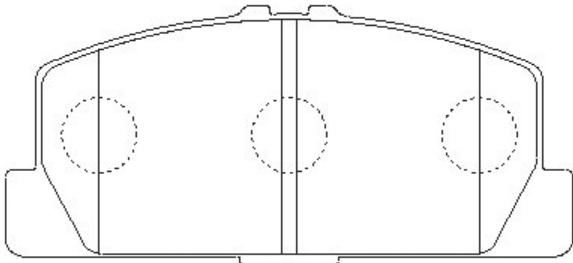
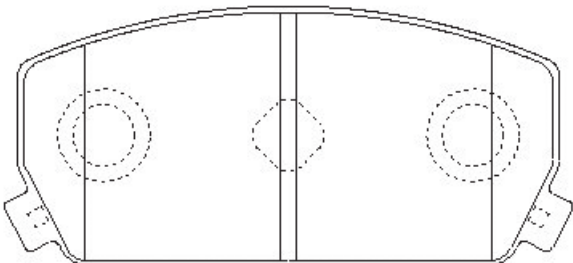
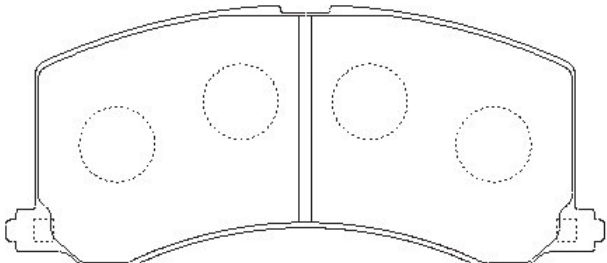
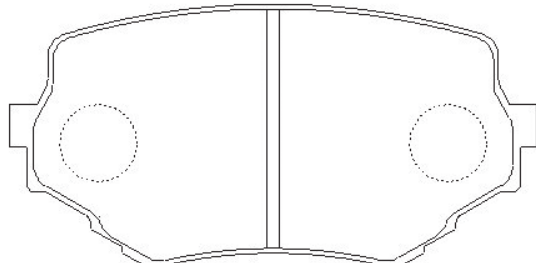
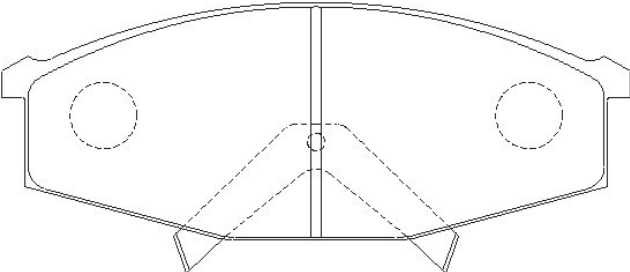
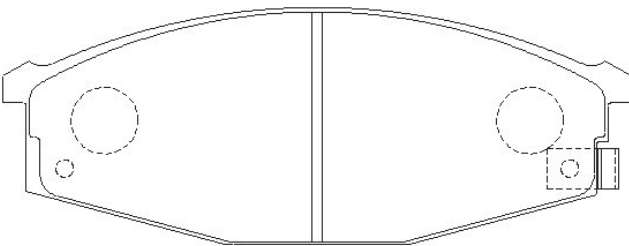
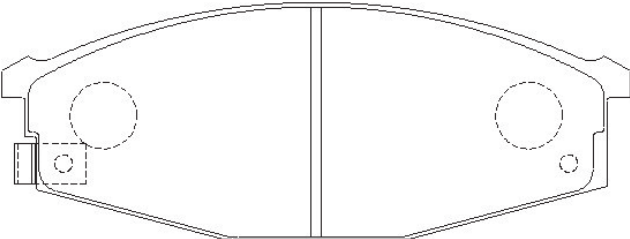
HN-No.	W	H	T	AKNo.	HN-No.	W	H	T	AKNo.
				MKNo.					MKNo.
HN-378	108.6	39.5	14.8	AN-448K					
				D9023-02					
									
HN-379									AN-472K
									D6084-02
									
HN-381	111.4	48.6	15.0	AN-449K	HN-382	110.2	54.5	14.3	AN-451K
				D9025-02					D9024-02
									
HN-383						142.0	53.5	16.3	AN-390K
									D1209M-02
									
									

HN-No.	W	H	T	AKNo.	HN-No.	W	H	T	AKNo.
				MKNo.					MKNo.
HN-384	191.0	62.0	20.5	AN-429WK					
				D4041-02					
HN-385						128.1	55.0	15.5	AN-407WK
						126.7	57.0	15.5	D2142M-02
HN-386	116.0	53.3	16.0	A-SM490K					
				D2155-TX					

HN-No.	W	H	T	AKNo.	HN-No.	W	H	T	AKNo.
				MKNo.					MKNo.
HN-387									AN-458WK
									D2160M-02

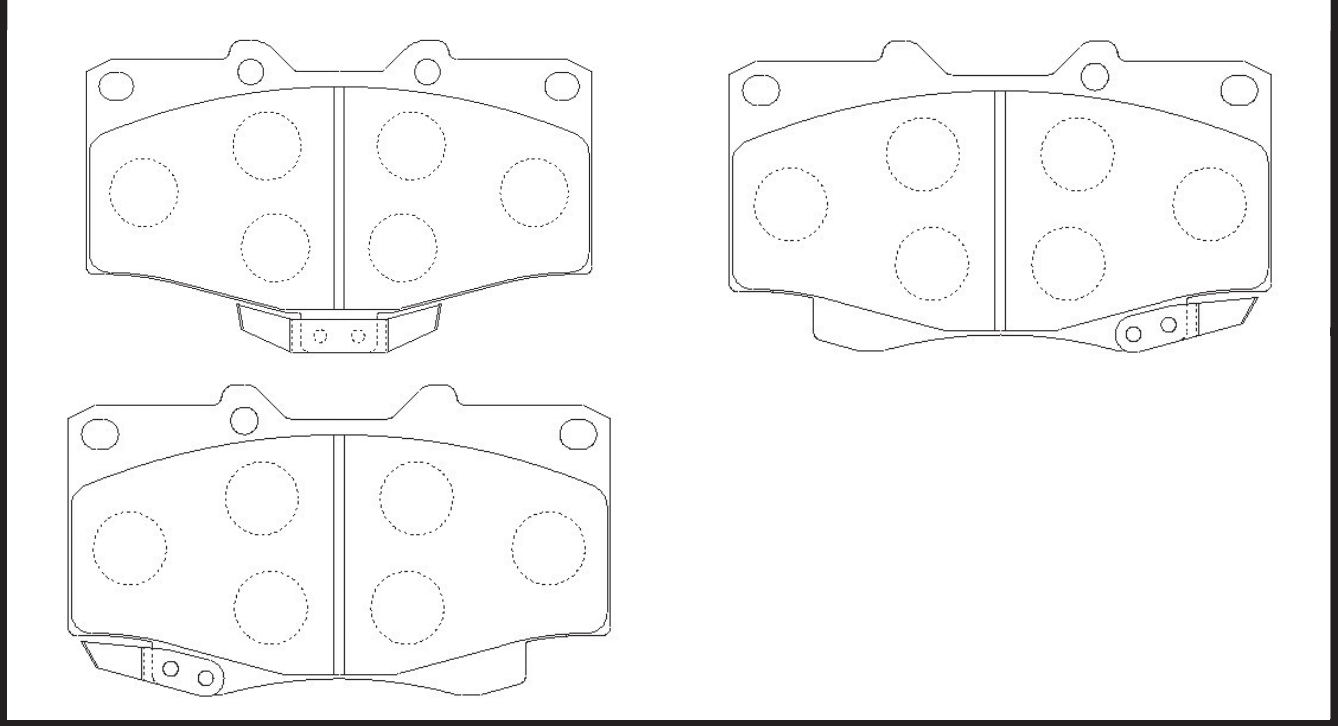

HN-388				166.5	63.2	17.8	AN-409WK
							D2115M-02

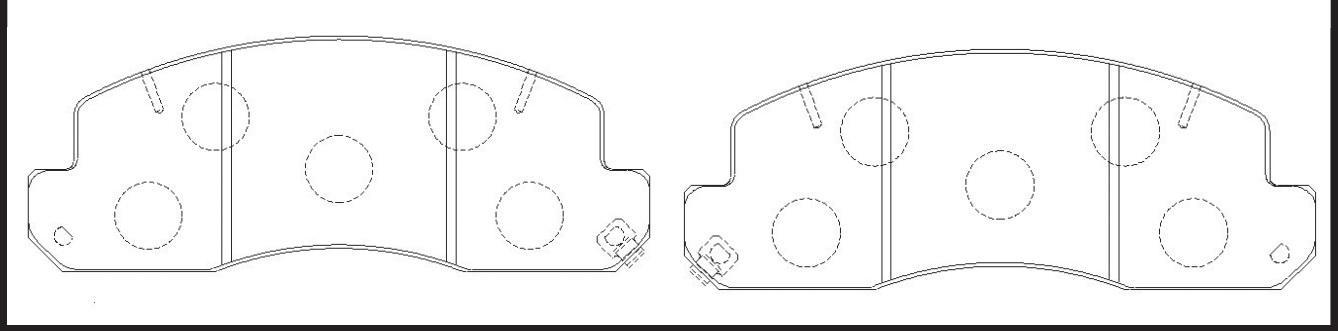

HN-390				137.8	59.6	16.8	AN-463WK
							D7036-02

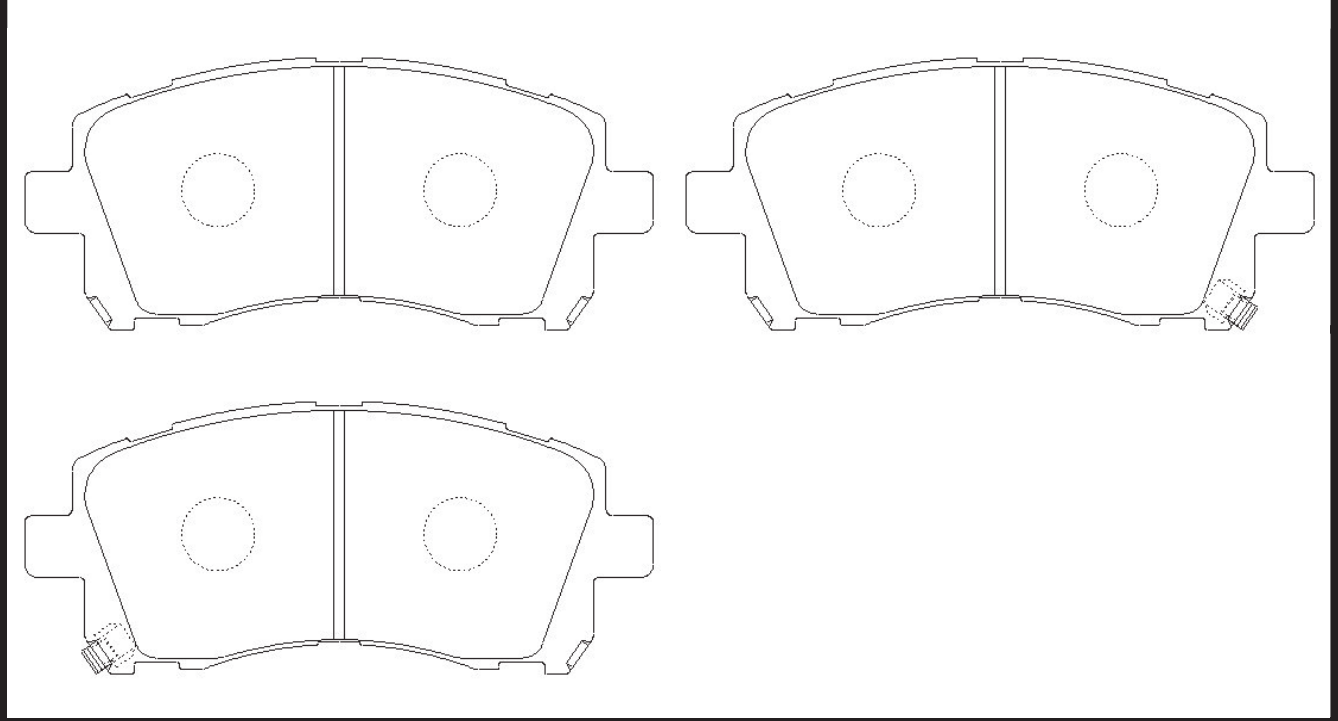

HN-No.	W	H	T	AKNo.	HN-No.	W	H	T	AKNo.
				MKNo.					MKNo.
HN-391						78.8	59.2	15.0	AN-468WK
									D6086M-02

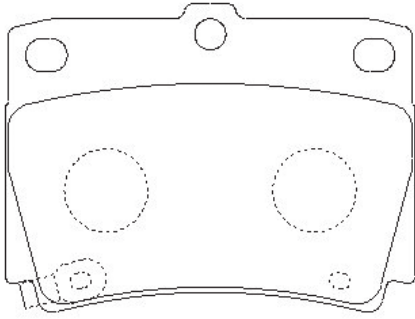
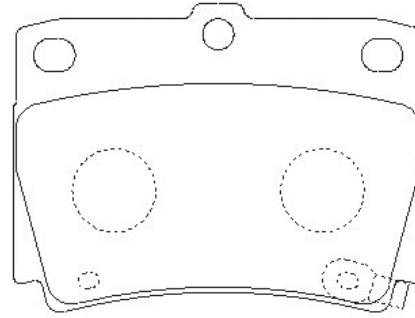
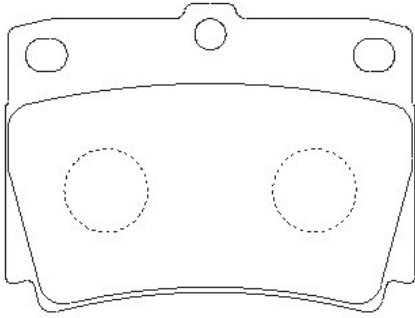

HN-392	202.4	64.5	17.8		HN-393	119.2	64.2	15.0	AN-456K
				D3065-02					

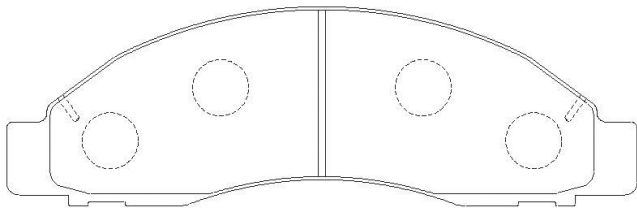

※discontinued

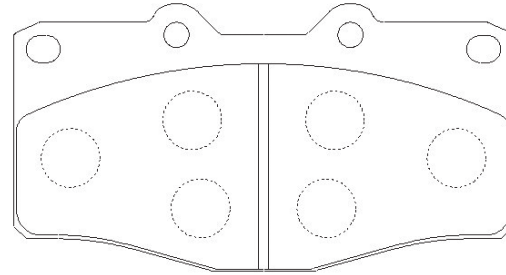

HN-394	107.3	58.4	15.0	AN-457K					
				D2168-02					

※discontinued

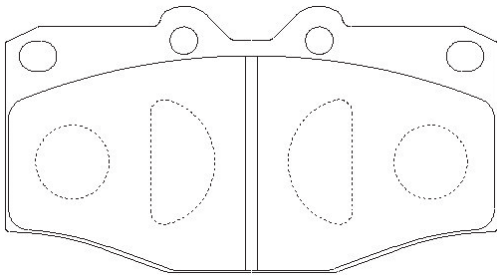

HN-No.	W	H	T	AKNo.	HN-No.	W	H	T	AKNo.
				MKNo.					MKNo.
HN-397						89.0	47.5	14.5	AN-492WK
									D5056M-02

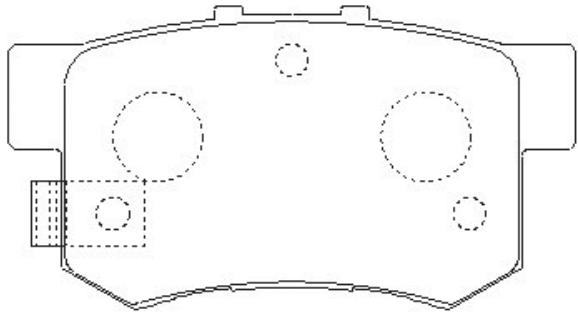
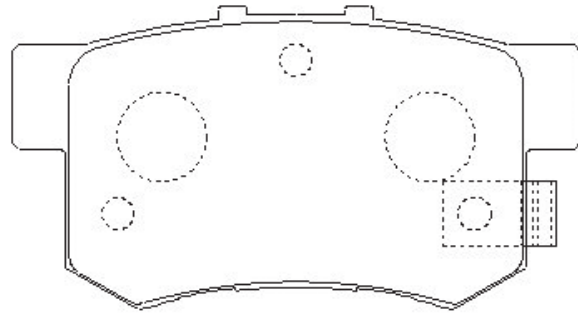
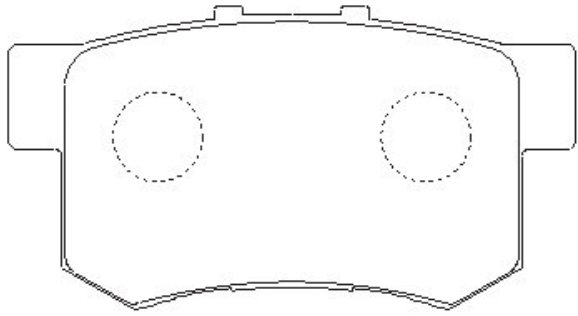

HN-398				137.8		54.0	16.8	AN-462WK
								D7068-02

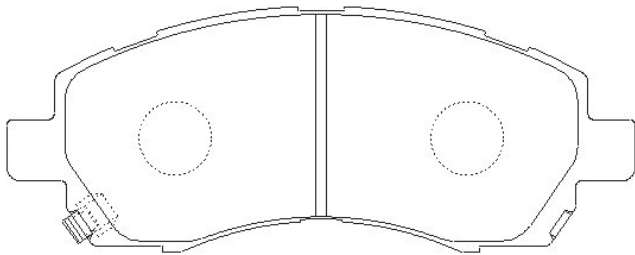
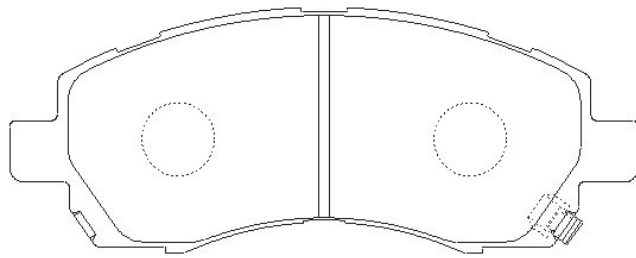
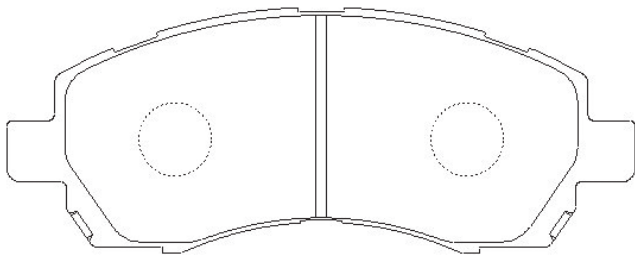

HN-No.	W	H	T	AKNo.	HN-No.	W	H	T	AKNo.
				MKNo.					MKNo.
HN-399									AN-408WK
									D2138M-02

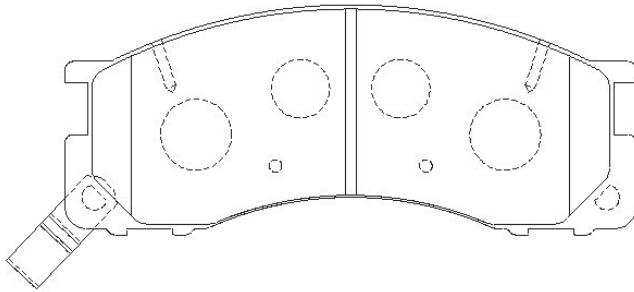
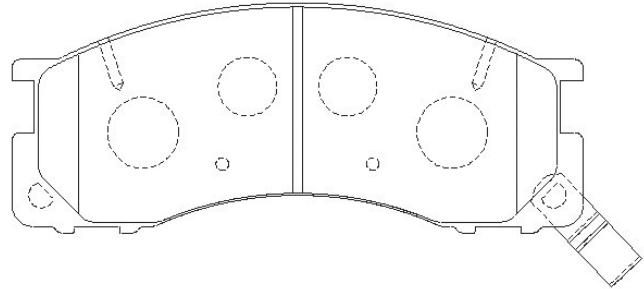
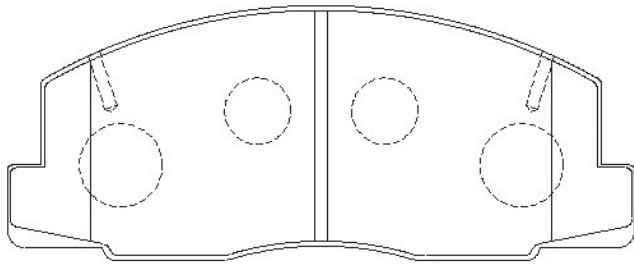

HN-400	125.7	45.3	15.4	AN-446K	HN-401	116.8	59.5	16.9	AN-465WK
				D0033-02					D2166-02

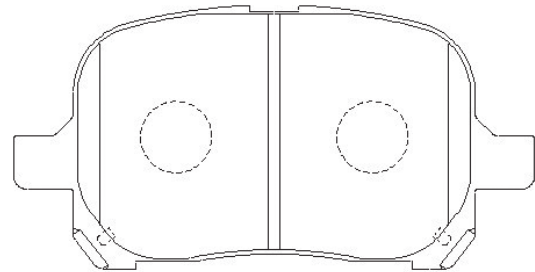
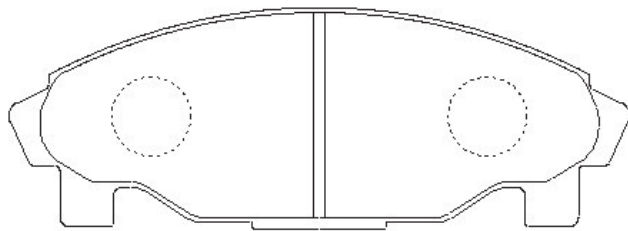

HN-402	116.0	53.3	18.0	A-SM474K					
				D2169-LX					

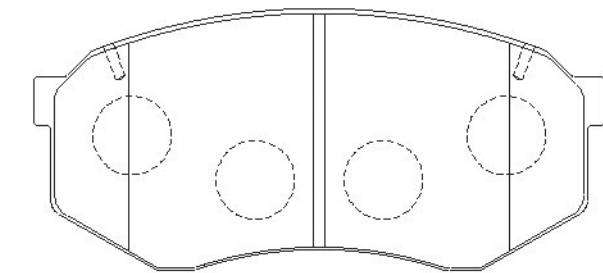

HN-No.	W	H	T	AKNo.	HN-No.	W	H	T	AKNo.
				MKNo.					MKNo.
HN-403						149.8	59.0	15.8	AN-601WK
									D6039M-02

※Integrated into HN-233

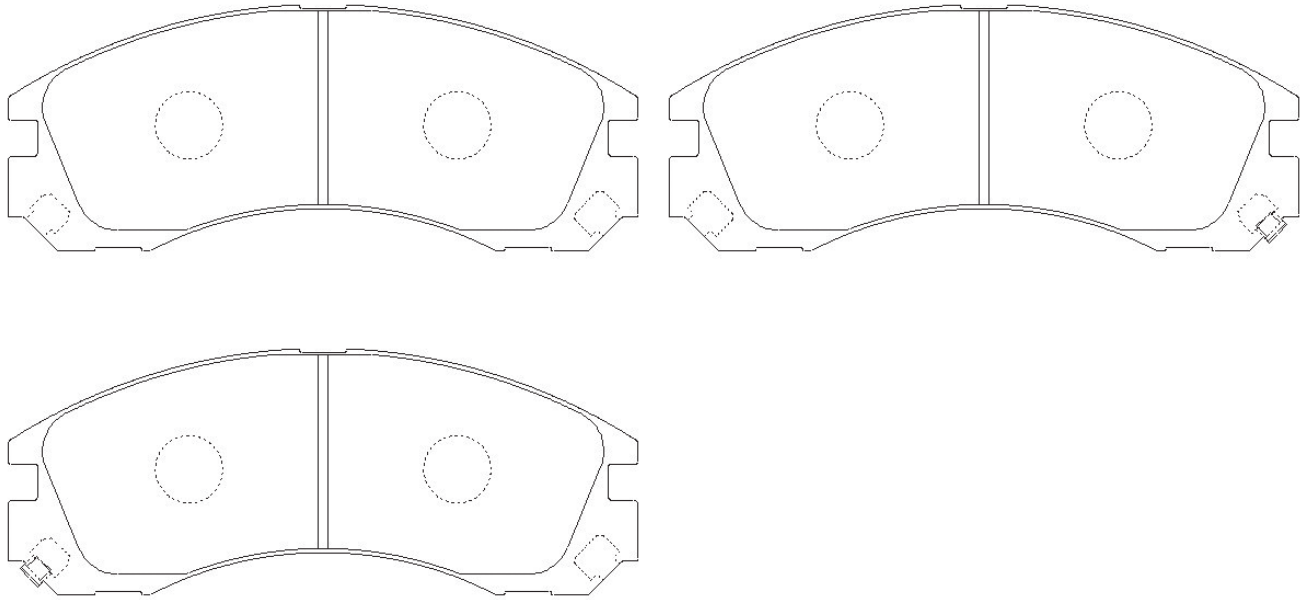

HN-404	W	H	T	AKNo.	HN-404	W	H	T	AKNo.
				MKNo.					MKNo.
						128.2	52.0	15.5	AN-469WK
									D2150M-02

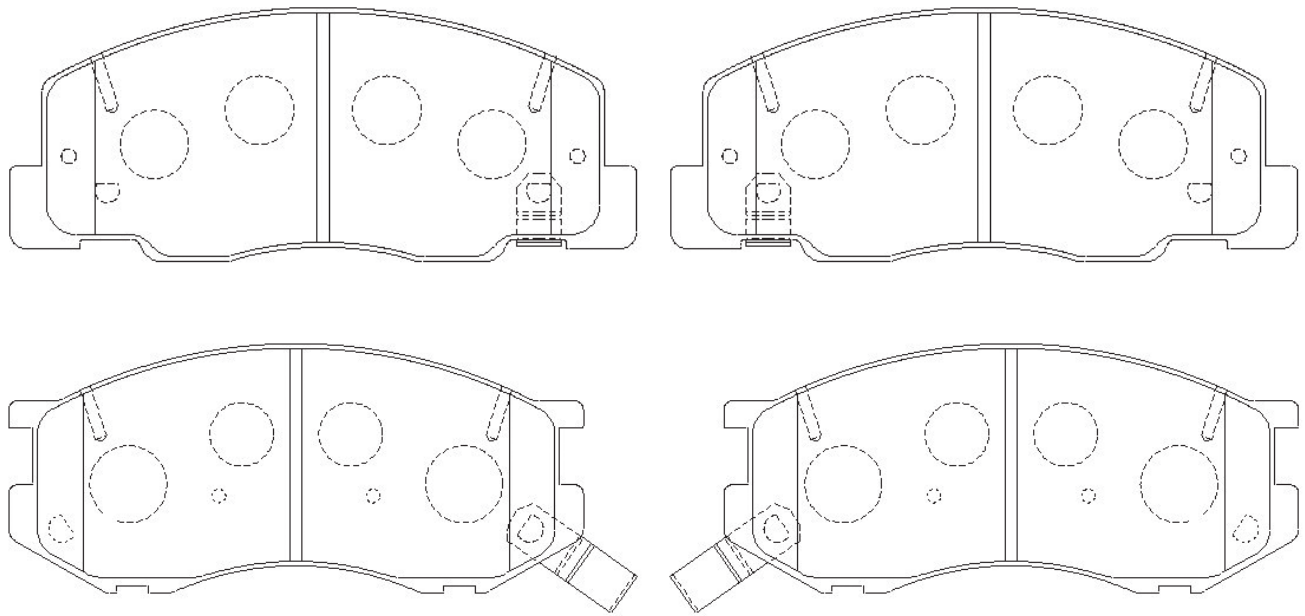

HN-No.	W	H	T	AKNo.	HN-No.	W	H	T	AKNo.
				MKNo.					MKNo.
HN-405									AN-470WK
									D2164M-02

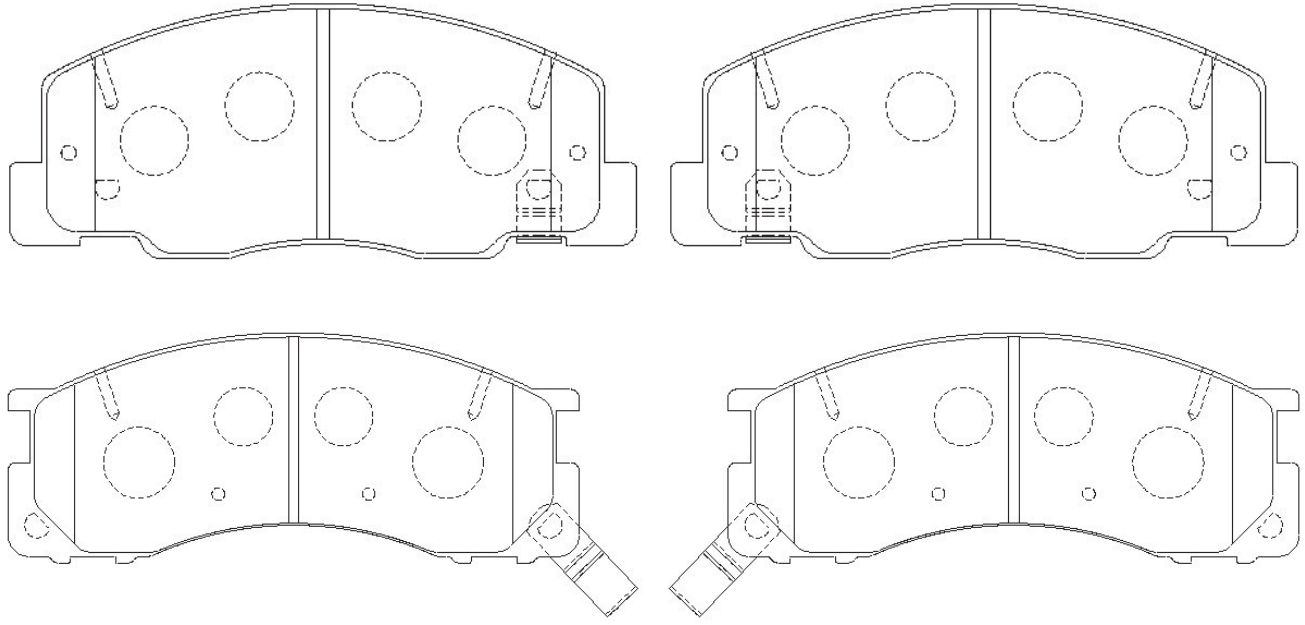

HN-406	106.3	50.0	15.0	AN-477K
				D9026-02

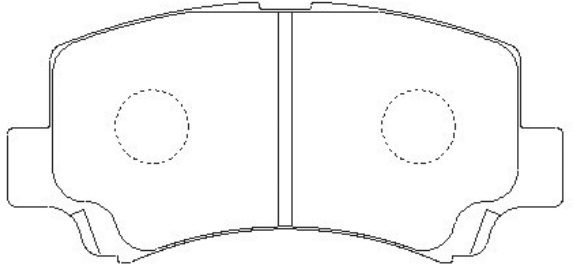

HN-407	125.2	59.9	19.5	AN-476K
				D6091-02

※1pad for R/L w/sensor holes, 6pads w/o sensor holes

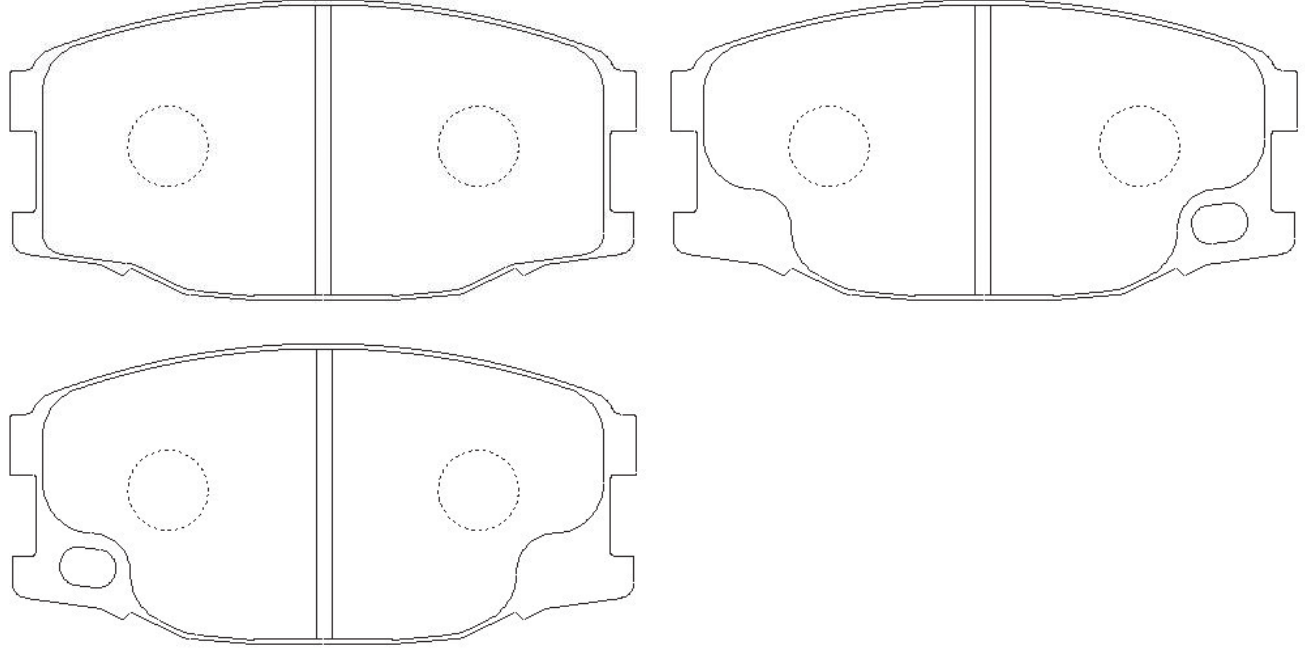

HN-No.	W	H	T	AKNo.	HN-No.	W	H	T	AKNo.
				MKNo.					MKNo.

HN-408						102.0	40.0	15.0	AN-305K
						88.0	40.0	15.0	D9017-02

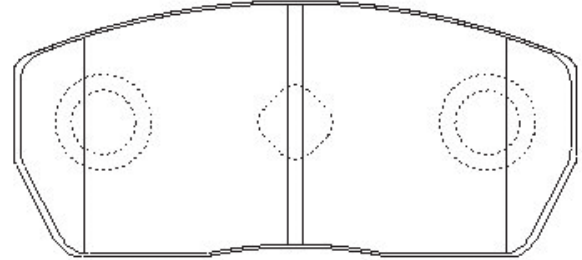
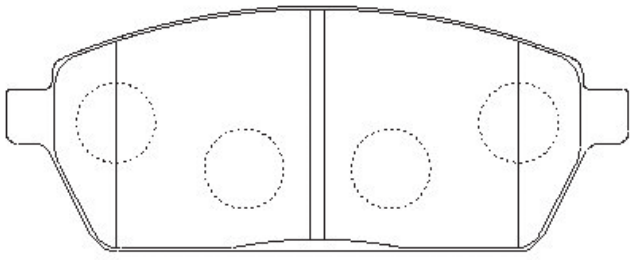

HN-409	116.0	40.0	17.5	AN-467K					
				D2163-02					

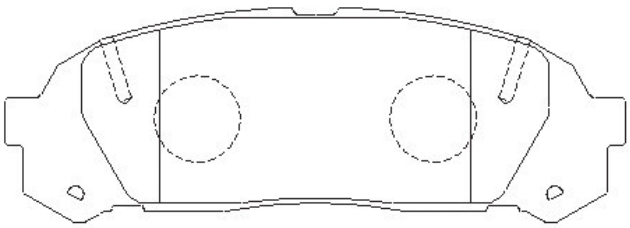

HN-410						108.5	48.0	15.3	AN-479WK
									D1215M-02

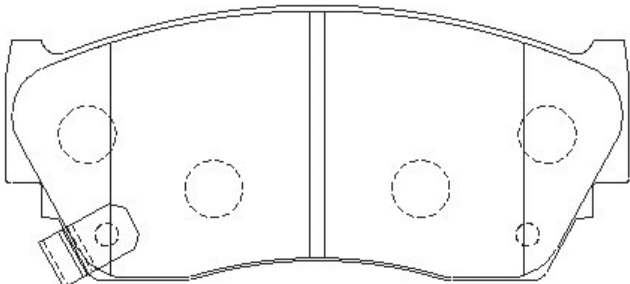
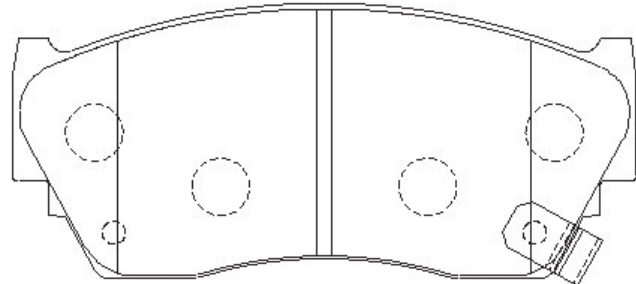
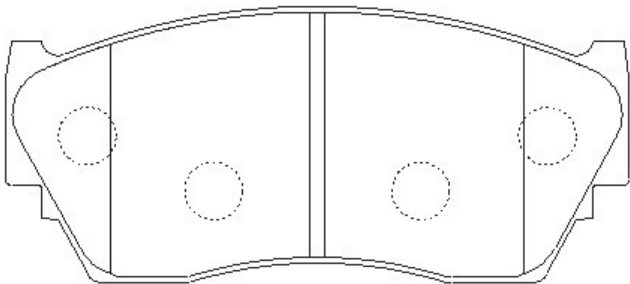

HN-411						119.3	78.5	17.3	AN-498WK
									D2177M-02

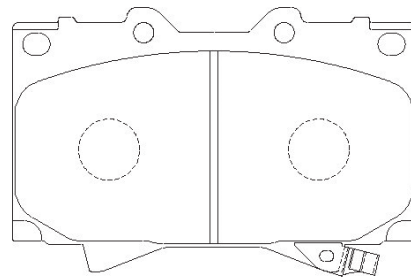
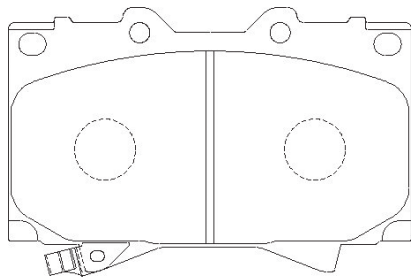

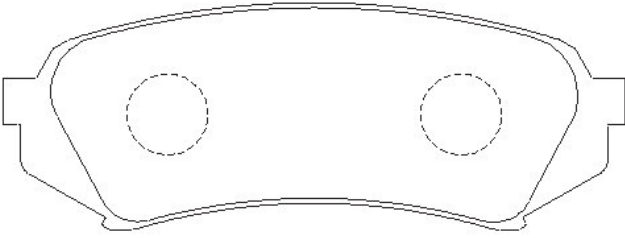
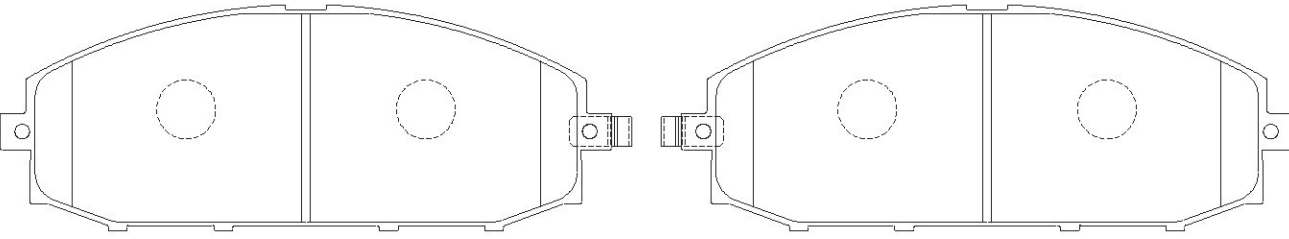
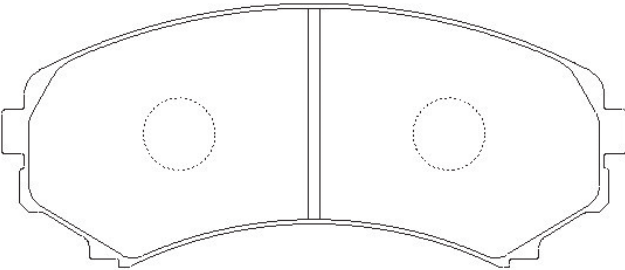
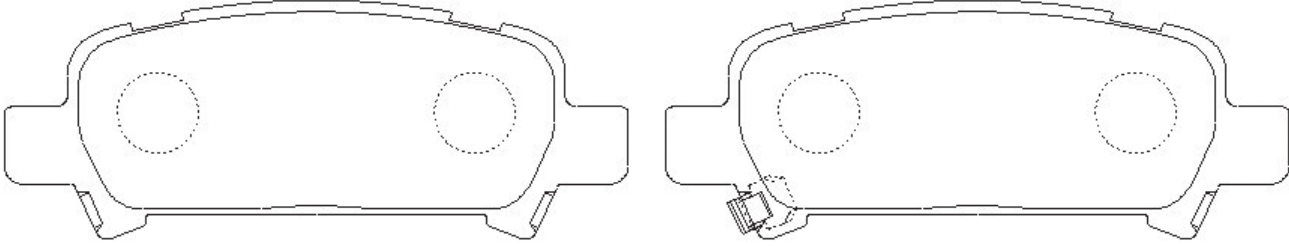
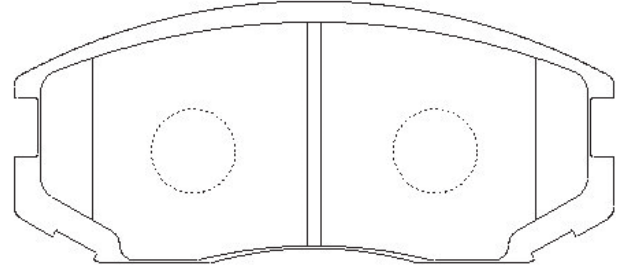
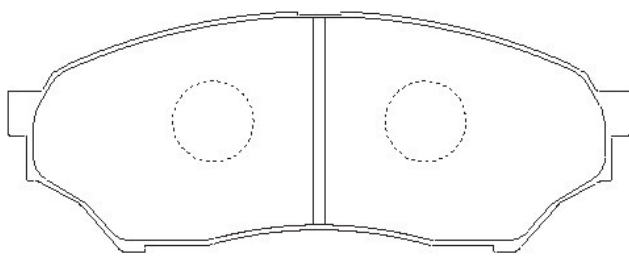
HN-No.	W	H	T	AKNo.	HN-No.	W	H	T	AKNo.
				MKNo.					MKNo.
HN-412	122.7	45.5	17.0	AN-499K					
				D2179-02					
									
HN-413					167.0	60.5	18.8	AN-488WK	
								D1218M-02	
									
HN-414	138.7	58.2	15.3	AN-493K					
				D6085-02					
									
HN-415					108.3	41.5	13.8	AN-475WK	
								D7069-02	
<p>※1pad w/sensor. 3pads w/o sensor</p> 									
HN-416	114.3	49.8	14.8	AN-478K	HN-417	123.2	48.2	15.4	AN-486K
				D0037-02					D6089-02
									

HN-No.	W	H	T	AKNo.	HN-No.	W	H	T	AKNo.
				MKNo.					MKNo.
HN-418									AN-494WK
									D3101M-02

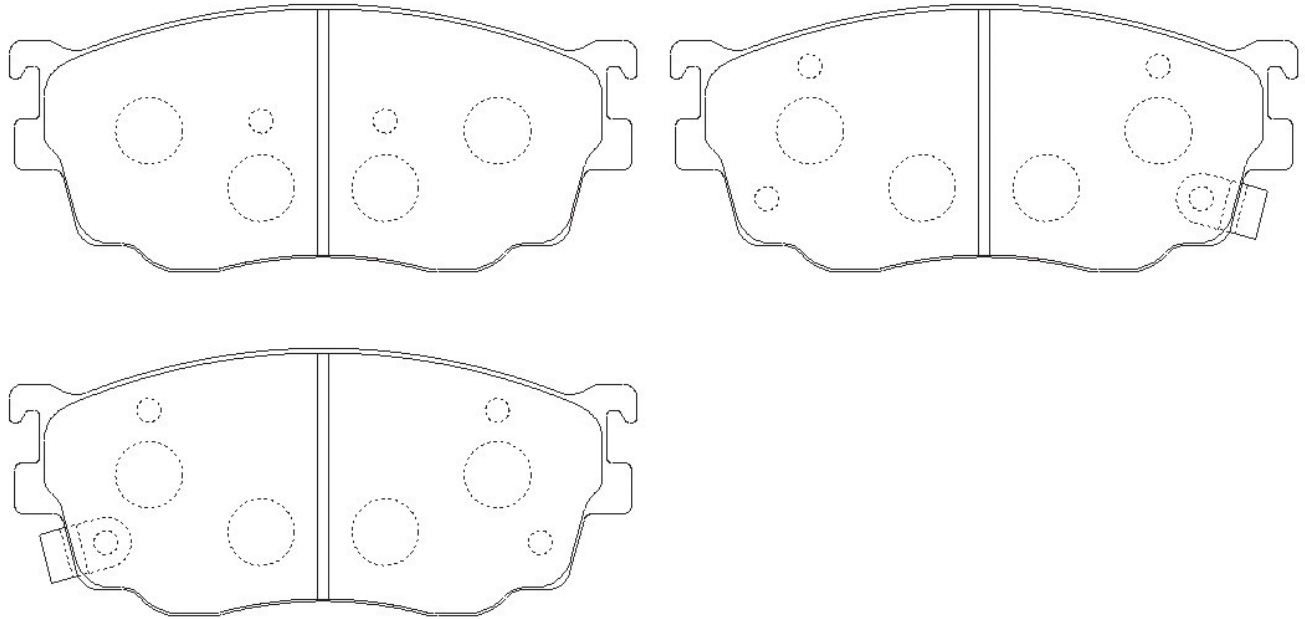

HN-419				156.8		53.5		15.8	AN-487WK
									D6097-02

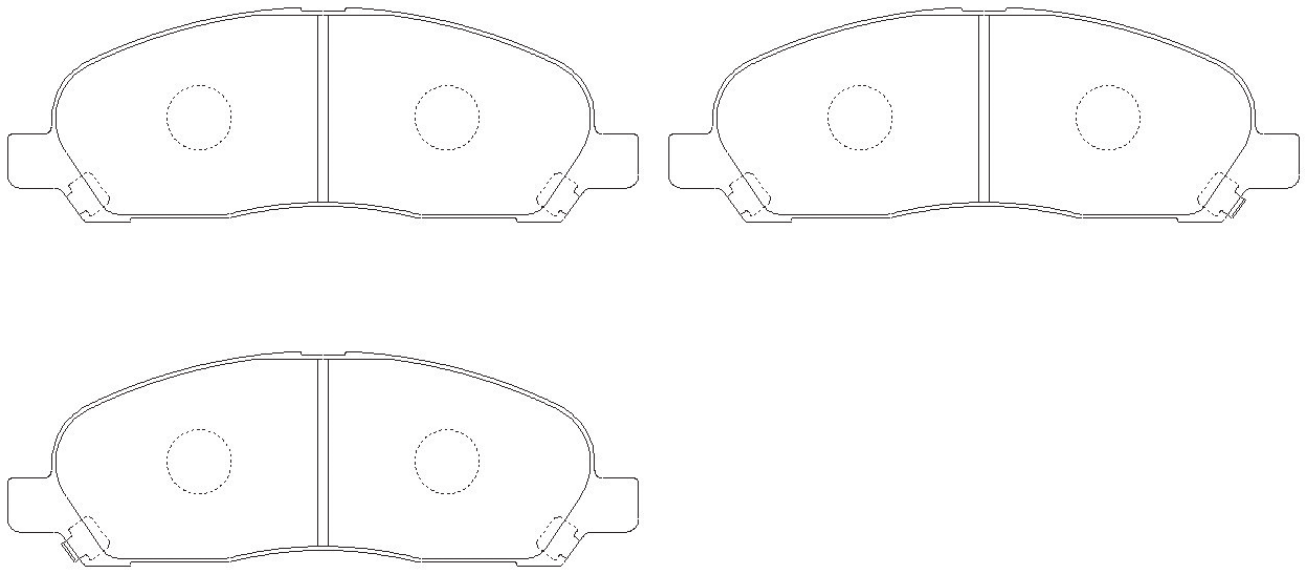

HN-420				108.5		48.0		15.8	AN-600WK
									D1236M-02

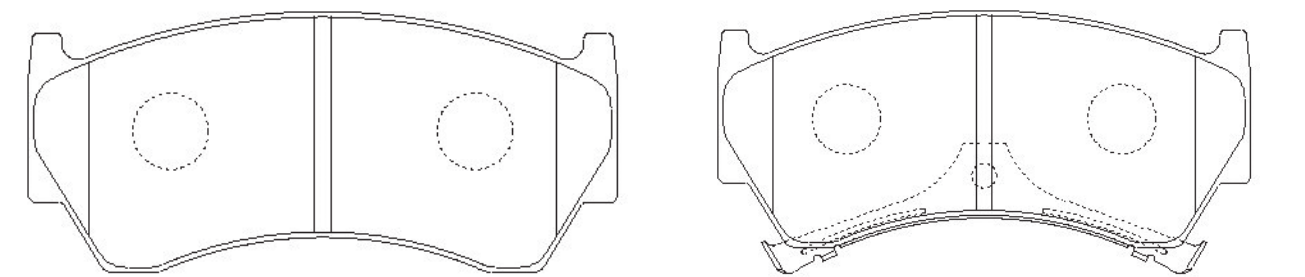

HN-No.	W	H	T	AKNo.	HN-No.	W	H	T	AKNo.
				MKNo.					MKNo.

HN-421	57.2	64.0	15.5	AN-489WK
				D2173M-02

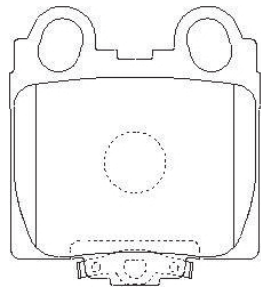

--	--	--	--	--

HN-422				AN-480WK
				D1145M-02

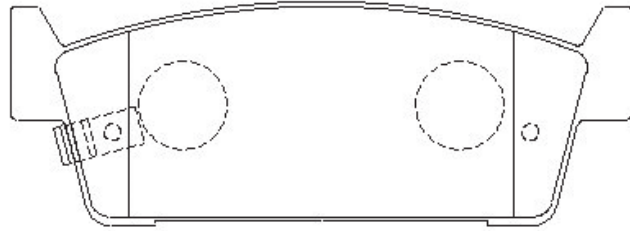
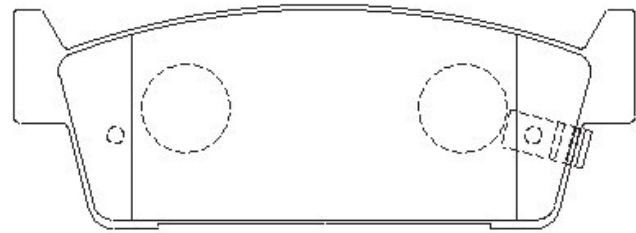
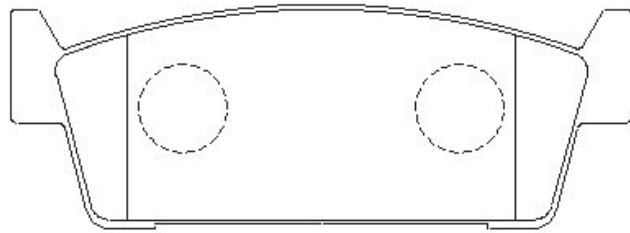

HN-423				AN-491WK
				D5119M-02

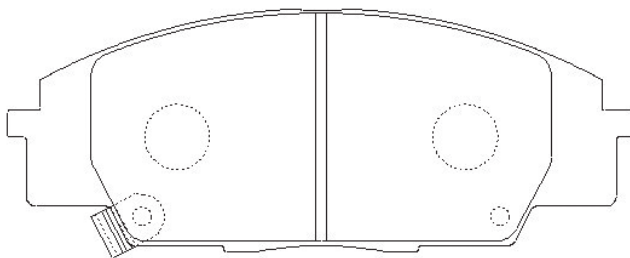
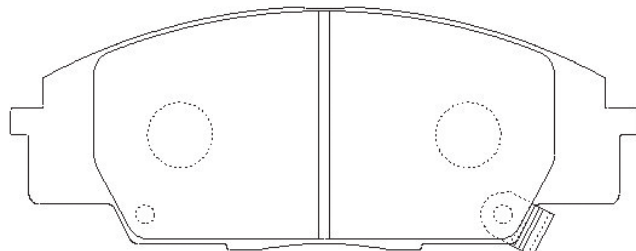
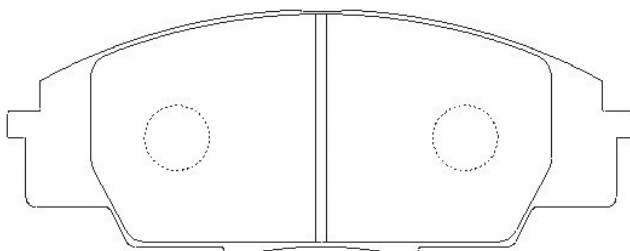

HN-No.	W	H	T	AKNo.	HN-No.	W	H	T	AKNo.
				MKNo.					MKNo.
HN-424						78.5	54.0	13.8	AN-484WK
									D2188M-02

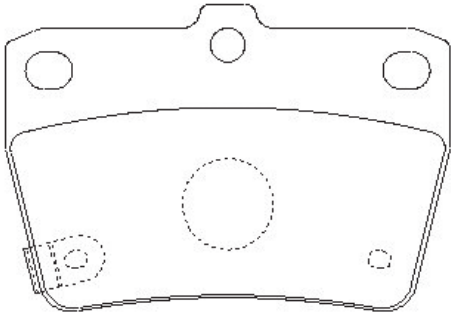
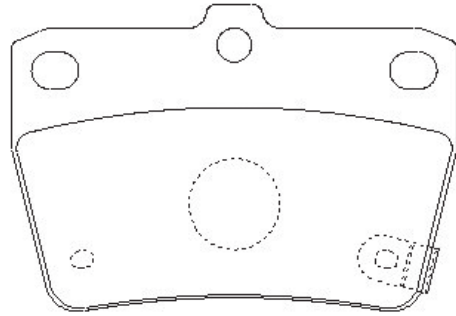
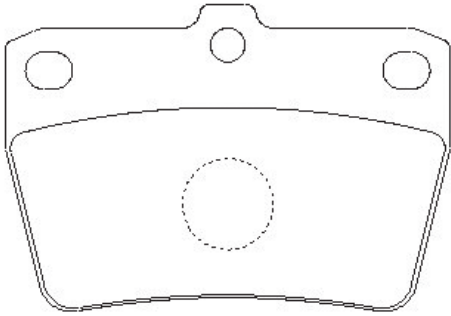

HN-425	123.0	51.7	15.3	AN-602K	HN-426	108.5	41.9	14.8	AN-610K
				D3109-02					

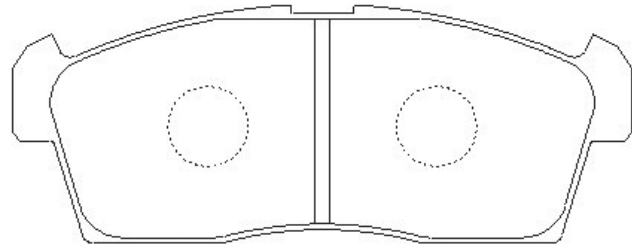
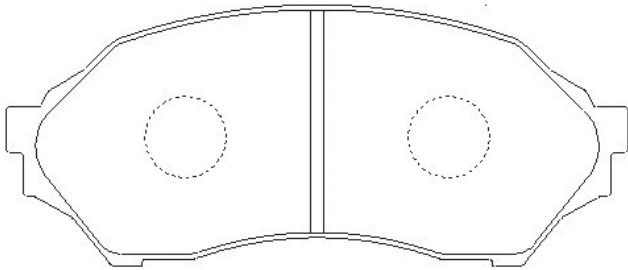

HN-427						95.0	49.6	15.3	AN-496WK
							115.4	49.6	15.3

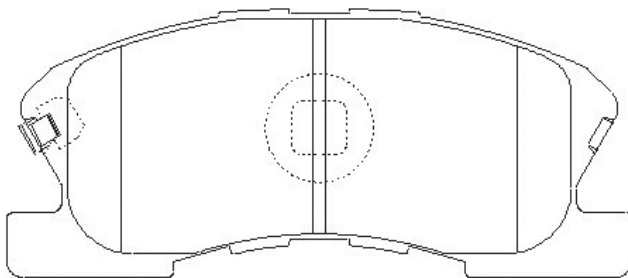
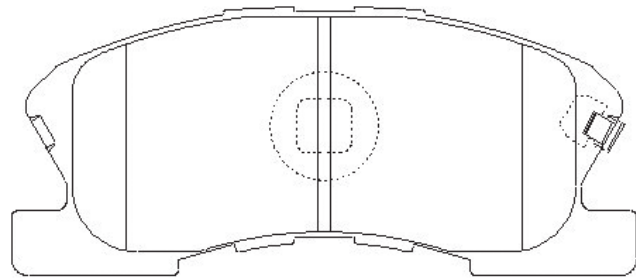
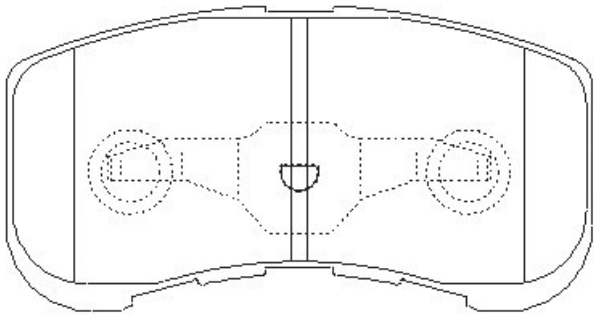

HN-No.	W	H	T	AKNo.	HN-No.	W	H	T	AKNo.
				MKNo.					MKNo.
HN-428						92.0	44.3	15.3	AN-608WK
						122.0	44.3	15.3	D6100-02

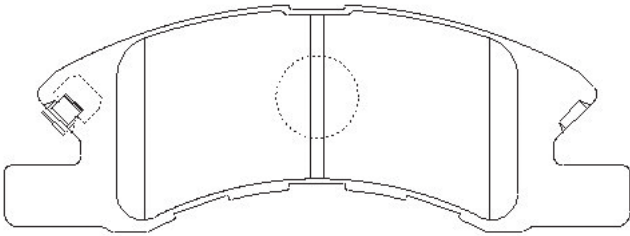
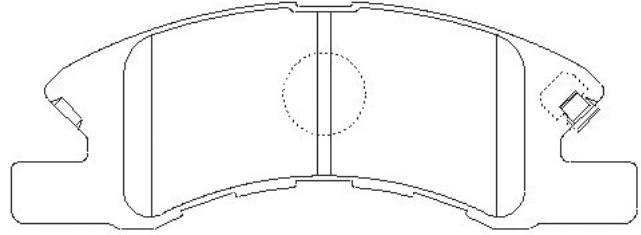
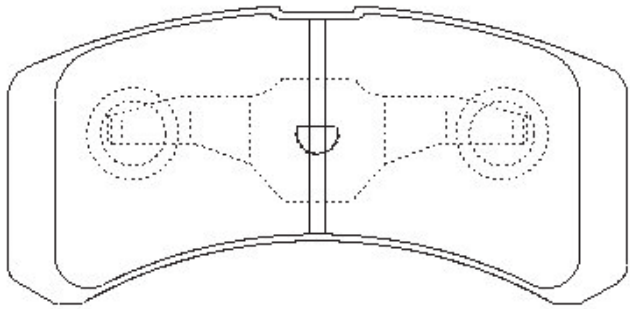

HN-429						78.8	58.2	14.4	AN-609WK
									D0038M-02

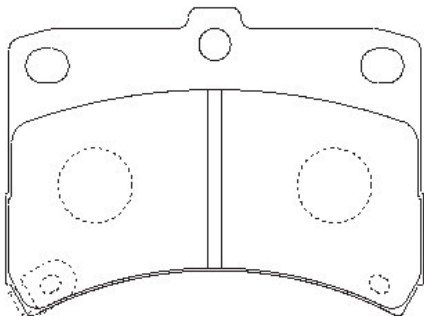
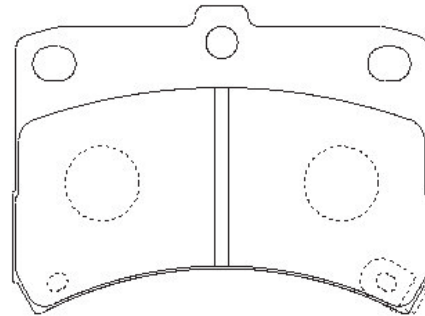
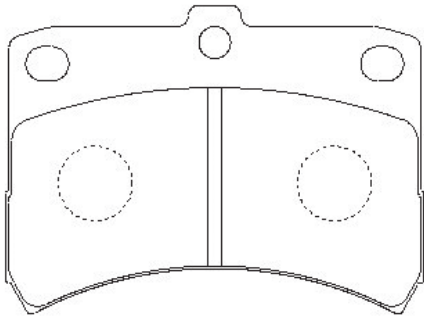

HN-430	117.5	58.5	17.4	AN-603K	HN-431	82.8	38.5	14.9	AN-604K
				D2180-02					

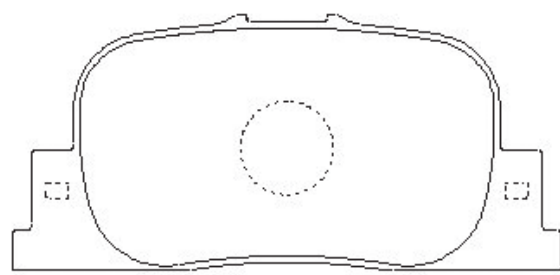
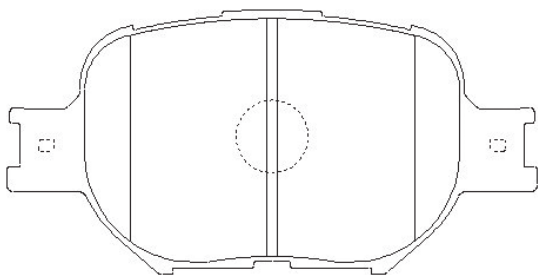

HN-No.	W	H	T	AKNo.	HN-No.	W	H	T	AKNo.
				MKNo.					MKNo.

HN-433						112.3	42.0	14.0	AN-612K
						99.1	40.0	14.0	D7047-02

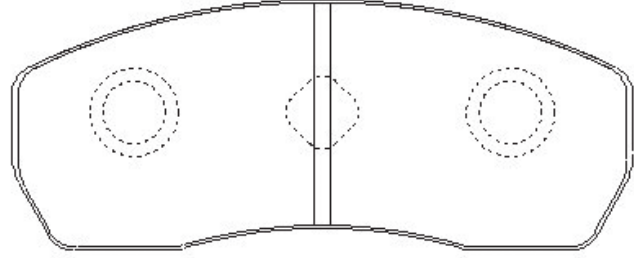
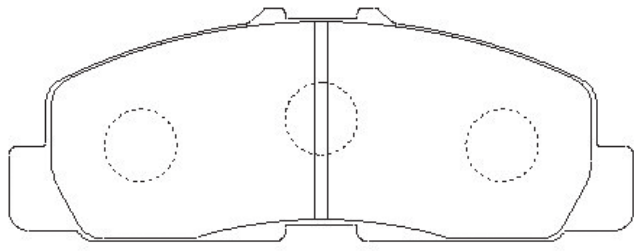

HN-434	137.0	54.0	17.5	AN-606K					
				D2186-02					

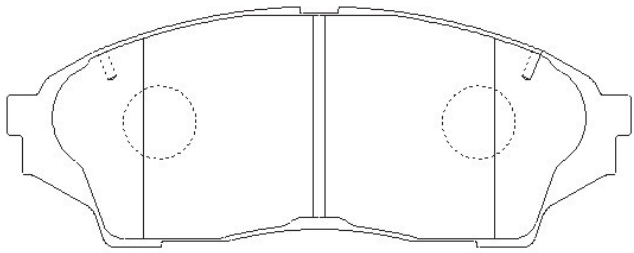

HN-435						135.0	48.5	15.8	AN-614WK
									D1233M-02

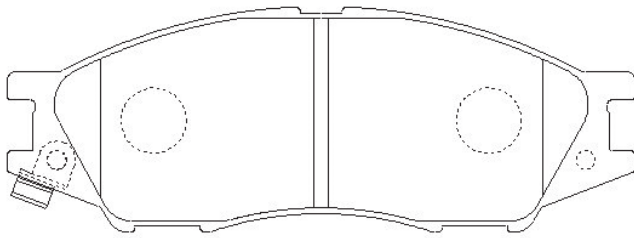
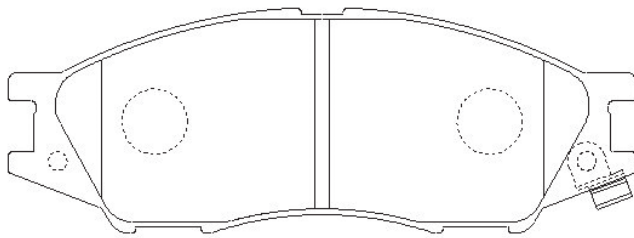
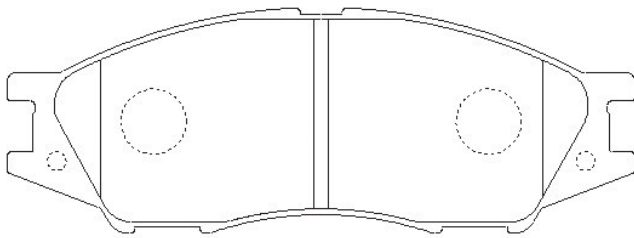

HN-No.	W	H	T	AKNo.	HN-No.	W	H	T	AKNo.
				MKNo.					MKNo.
HN-436						78.7	62.0	14.4	AN-611WK
									D5097M-02

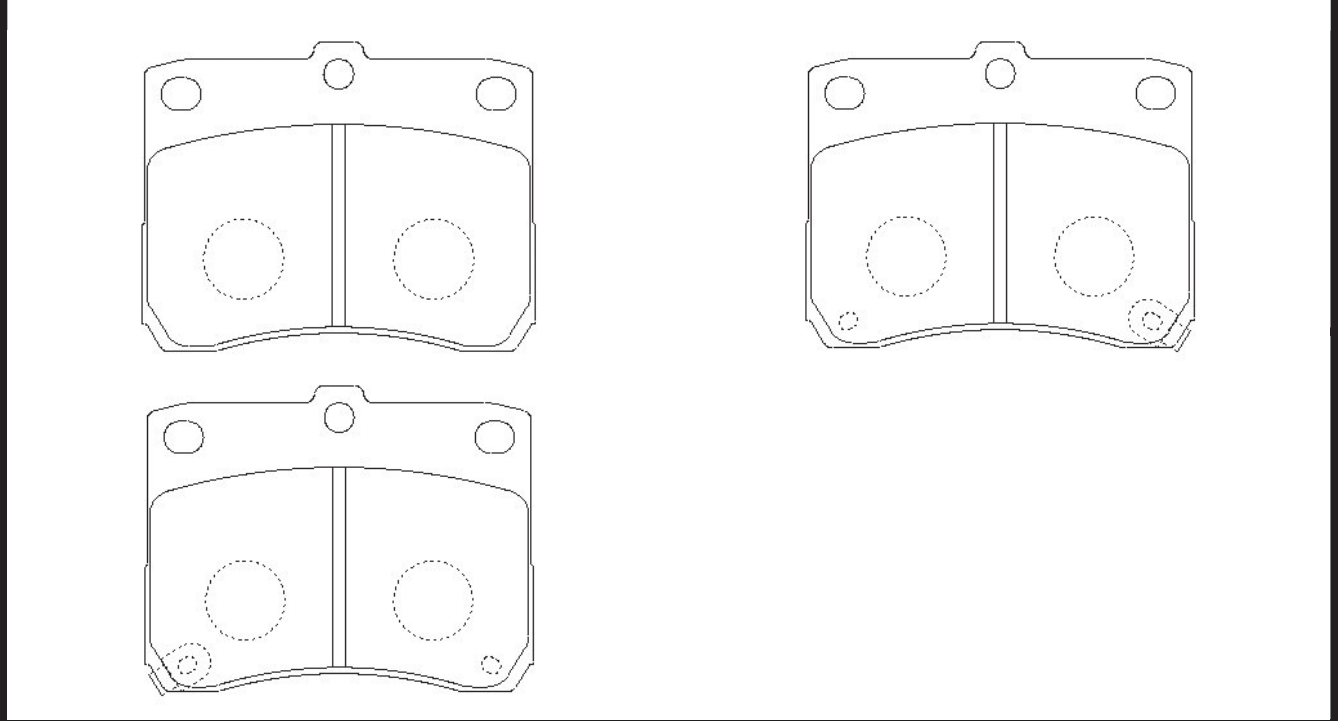

HN-437				103.4		39.1		14.8	AN-616K
									D6103-02

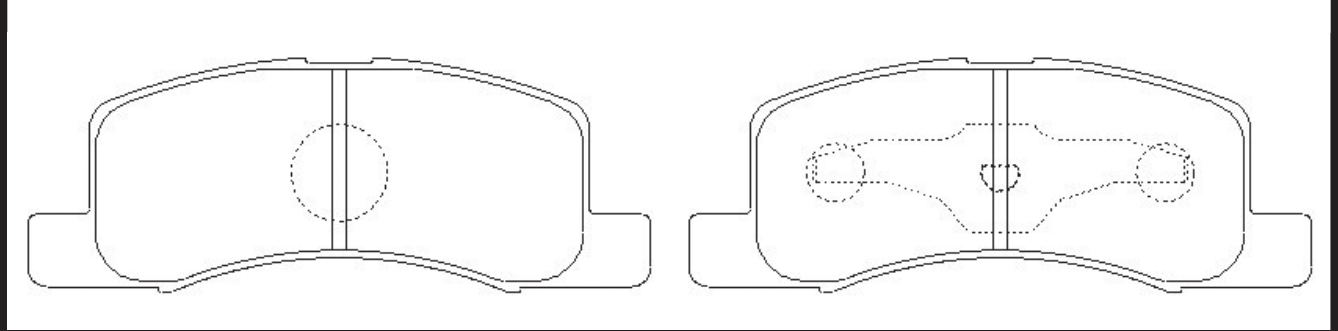

HN-438				106.0		42.5		14.9	AN-620WK
									D0041M-02

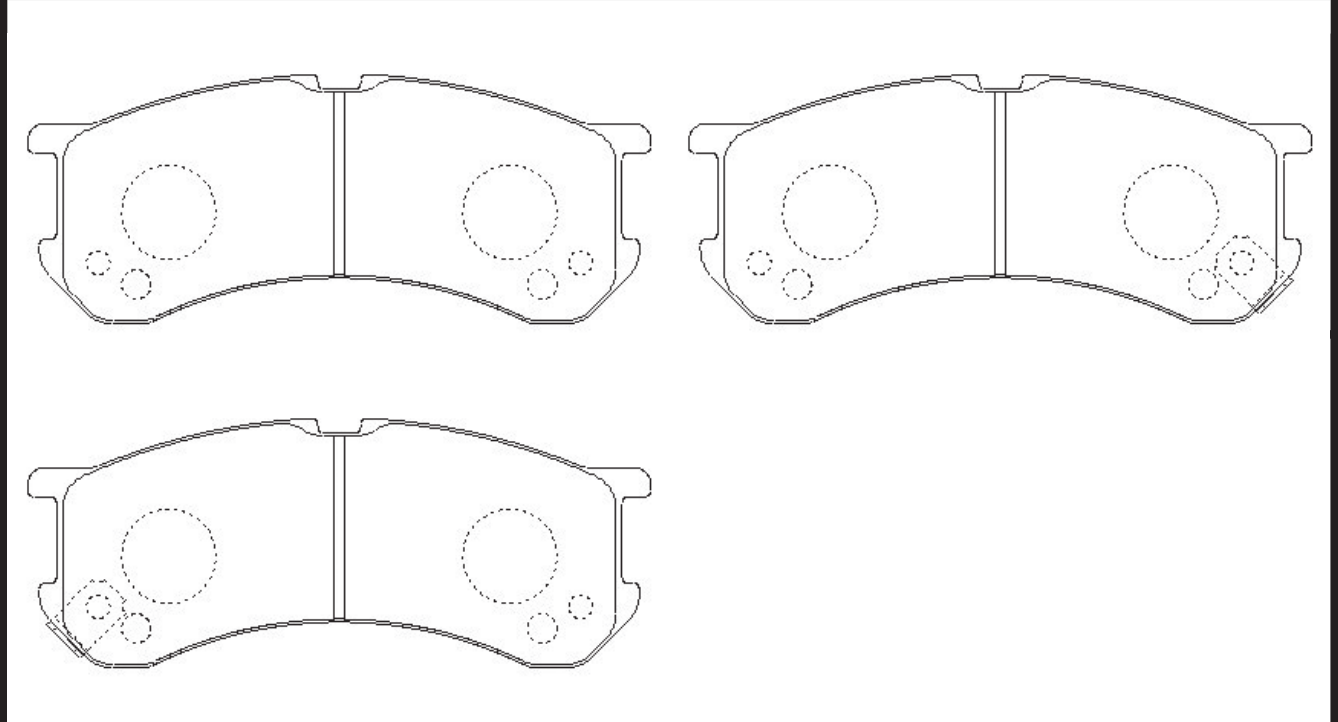

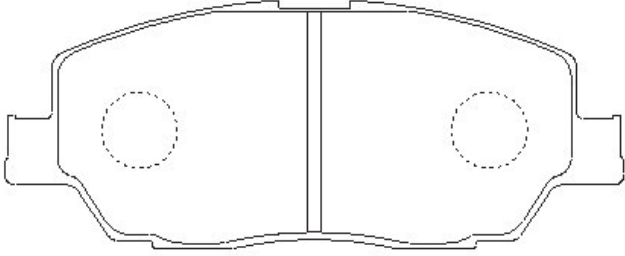
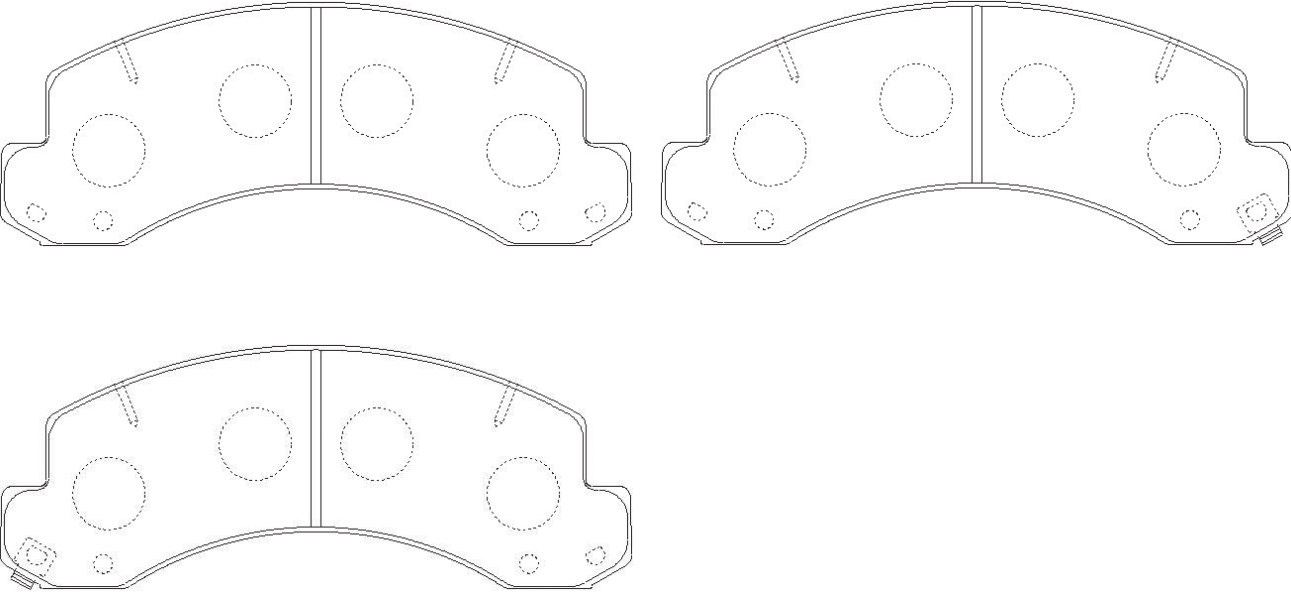
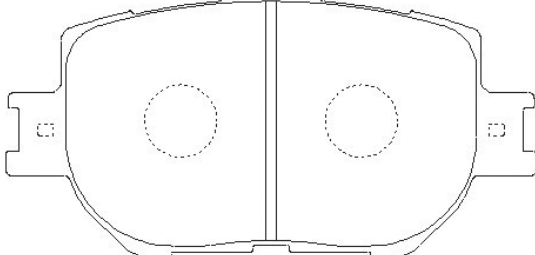
HN-No.	W	H	T	AKNo.	HN-No.	W	H	T	AKNo.
				MKNo.					MKNo.
HN-439	106.2	42.1	15.0	AN-621K					
				D9028-02					
									
HN-441					166.2	64.0	19.8	A-SM627WK	
								D2207M-02	
									
HN-442	117.6	58.5	17.3	AN-636K					
				D2193-02					
									

HN-No.	W	H	T	AKNo.	HN-No.	W	H	T	AKNo.
				MKNo.					MKNo.
HN-443						108.5	45.4	14.8	AN-661WK
									D9029M-02

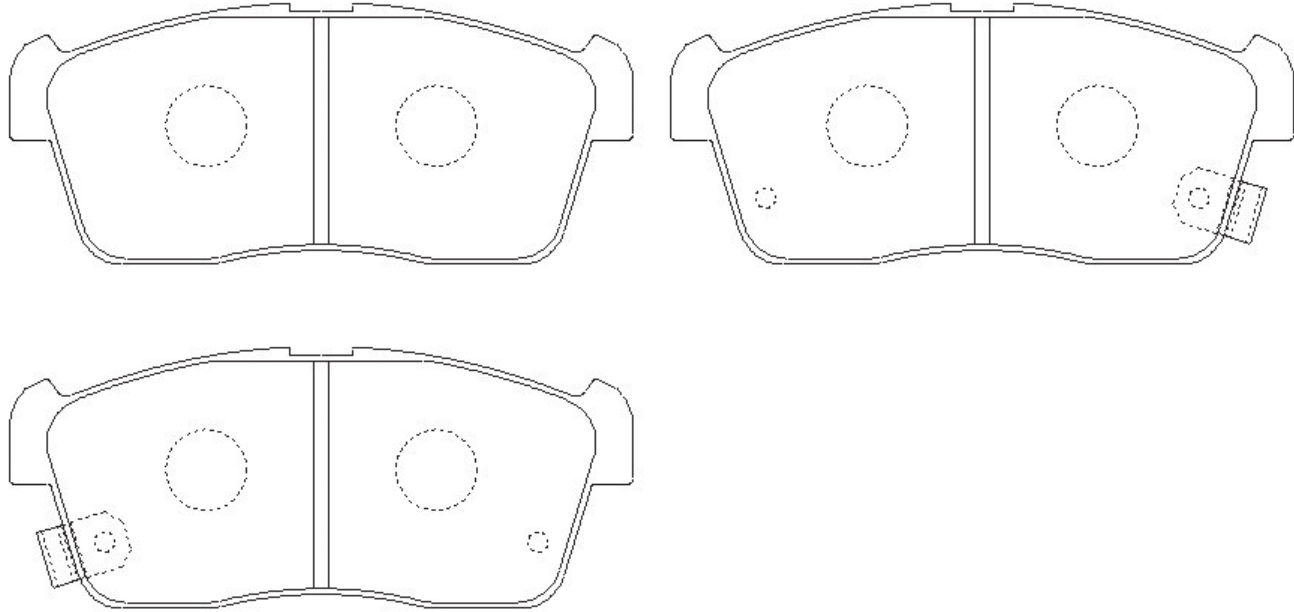

HN-444				157.0		58.6	16.4	AN-605WK
								D1231M-02

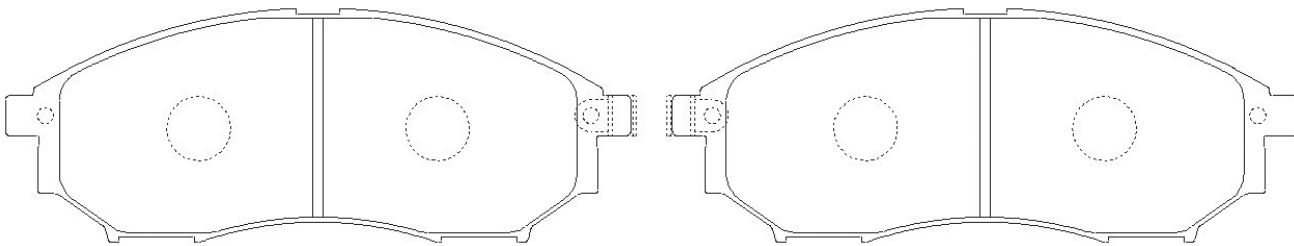

HN-445				148.7		58.2	17.3	AN-613WK
								D5100M-02

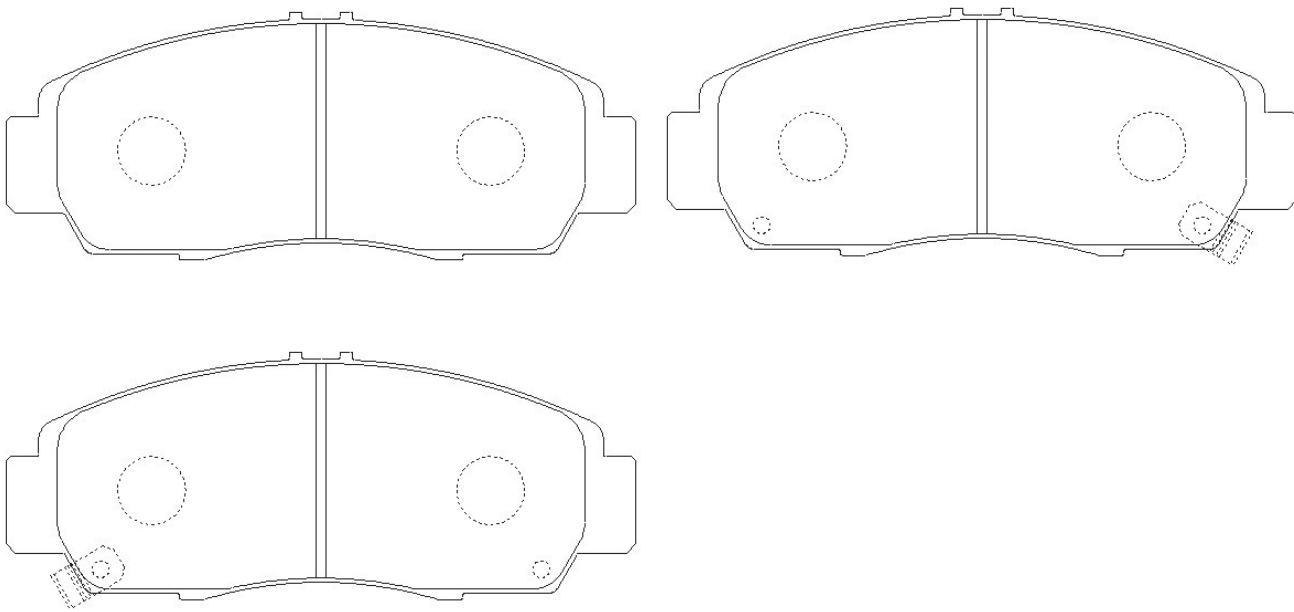

HN-No.	W	H	T	AKNo.	HN-No.	W	H	T	AKNo.
				MKNo.					MKNo.
HN-446						142.0	54.5	17.8	AN-483WK
									D1220M-02

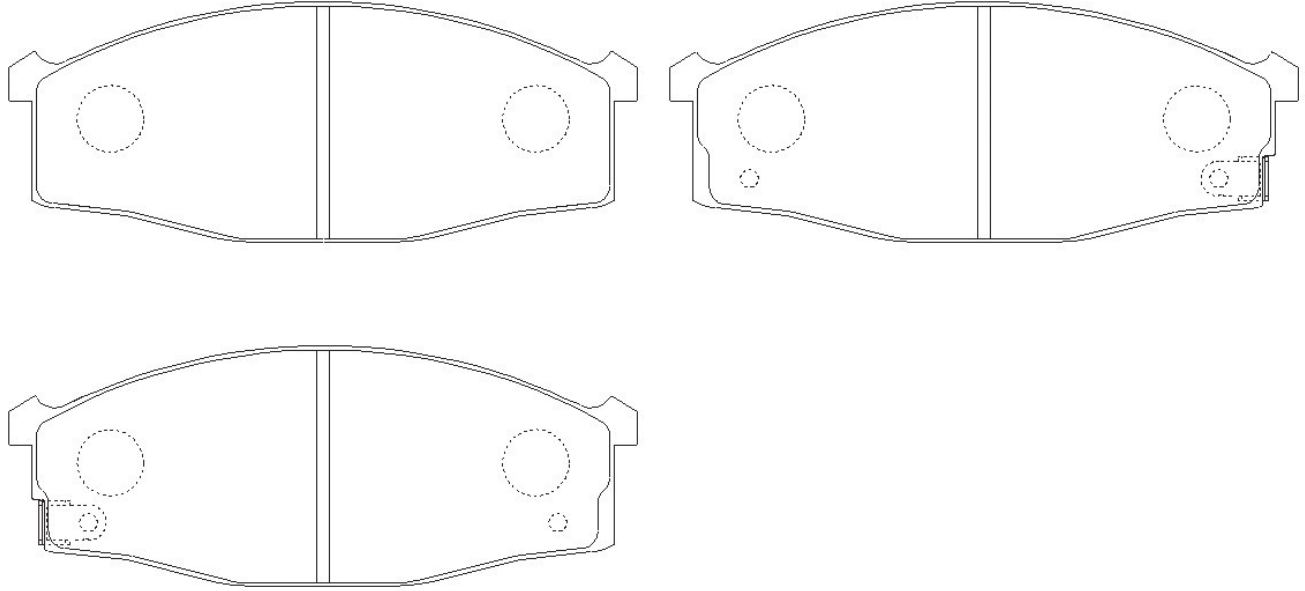

HN-447						123.0	60.8	17.3	AN-640K
									D2202-02

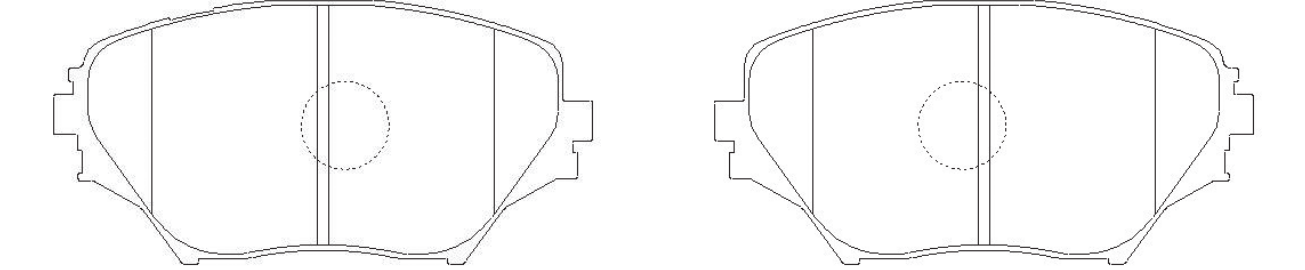

HN-448	116.8	59.5	16.8	AN-638WK					
				D2197-02					

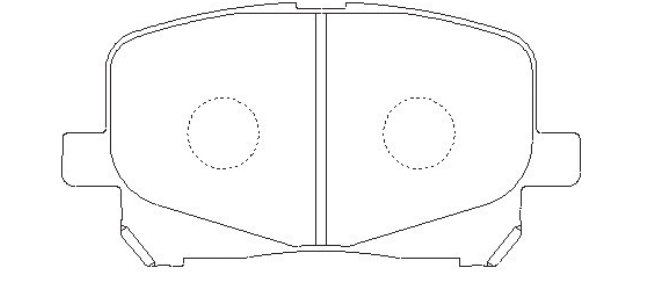

HN-No.	W	H	T	AKNo.	HN-No.	W	H	T	AKNo.
				MKNo.					MKNo.
HN-449									AN-639WK
									D2198M-02

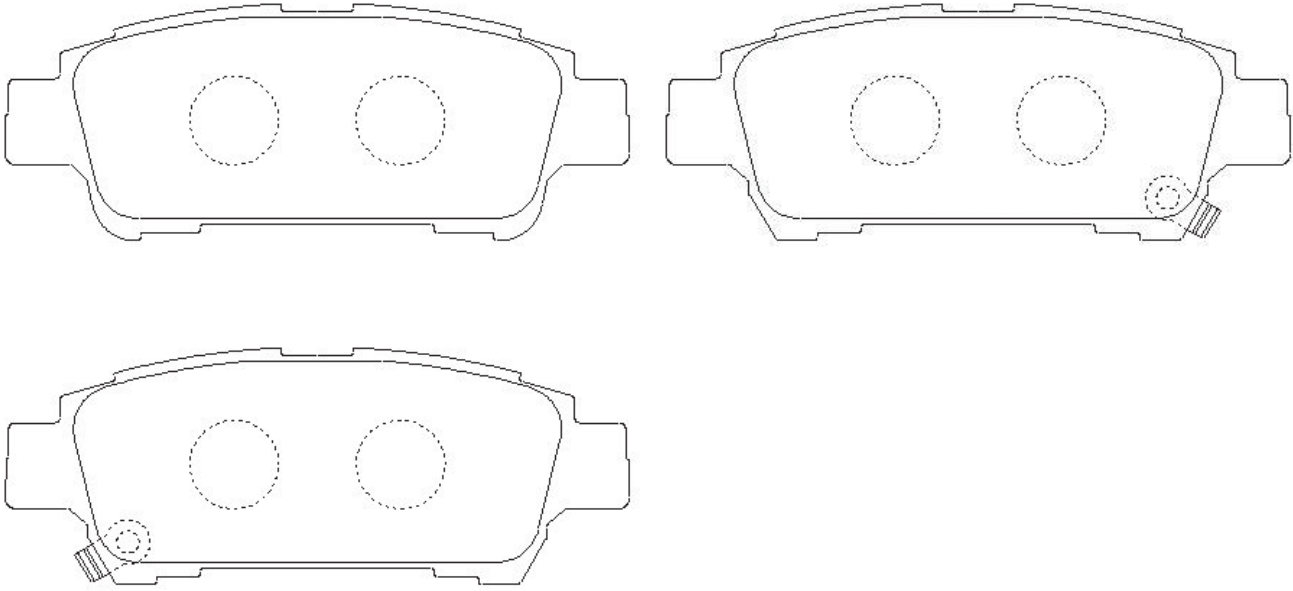

HN-450				91.0		44.5		15.3	AN-632WK
				111.5		44.5		15.3	D6106-02

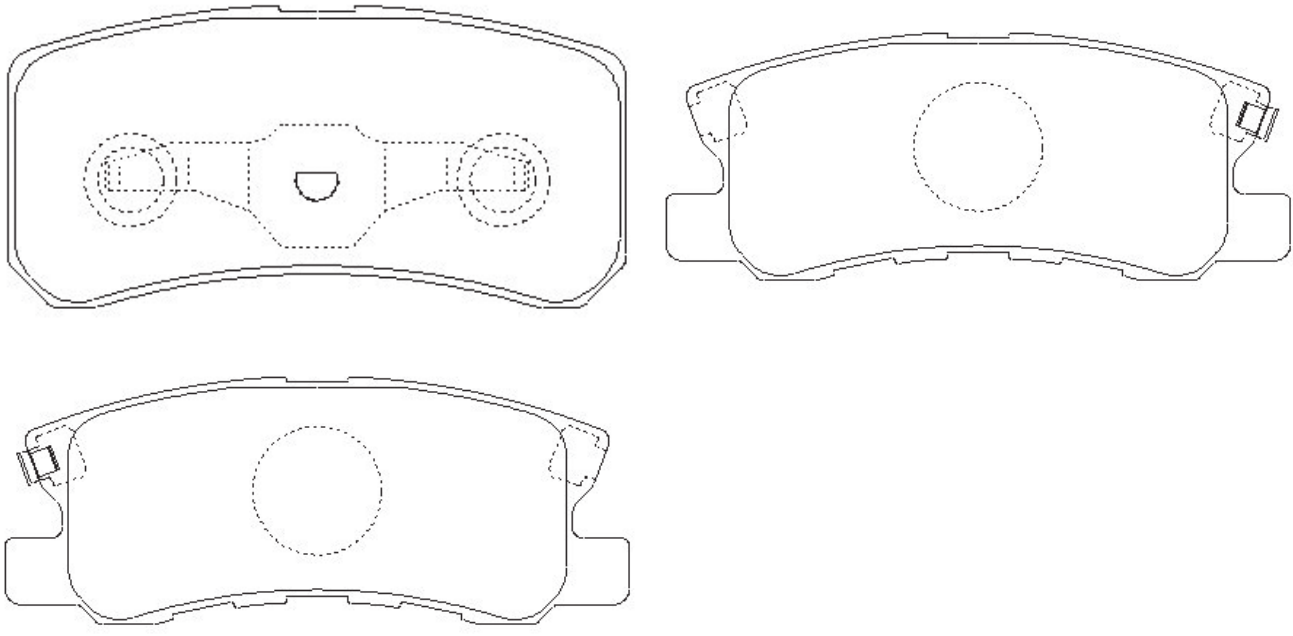

HN-451				88.4		49.0		13.8	AN-345K
									D0015-02

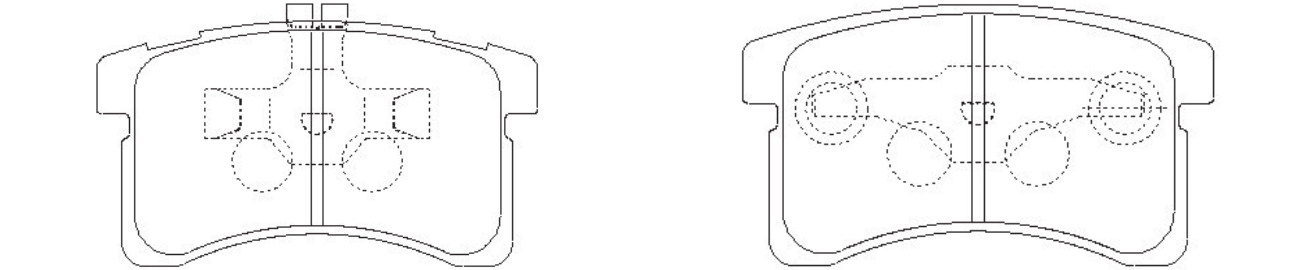

HN-No.	W	H	T	AKNo.	HN-No.	W	H	T	AKNo.
				MKNo.					MKNo.
HN-452						144.2	49.0	14.2	AN-675WK
									D1250M-02

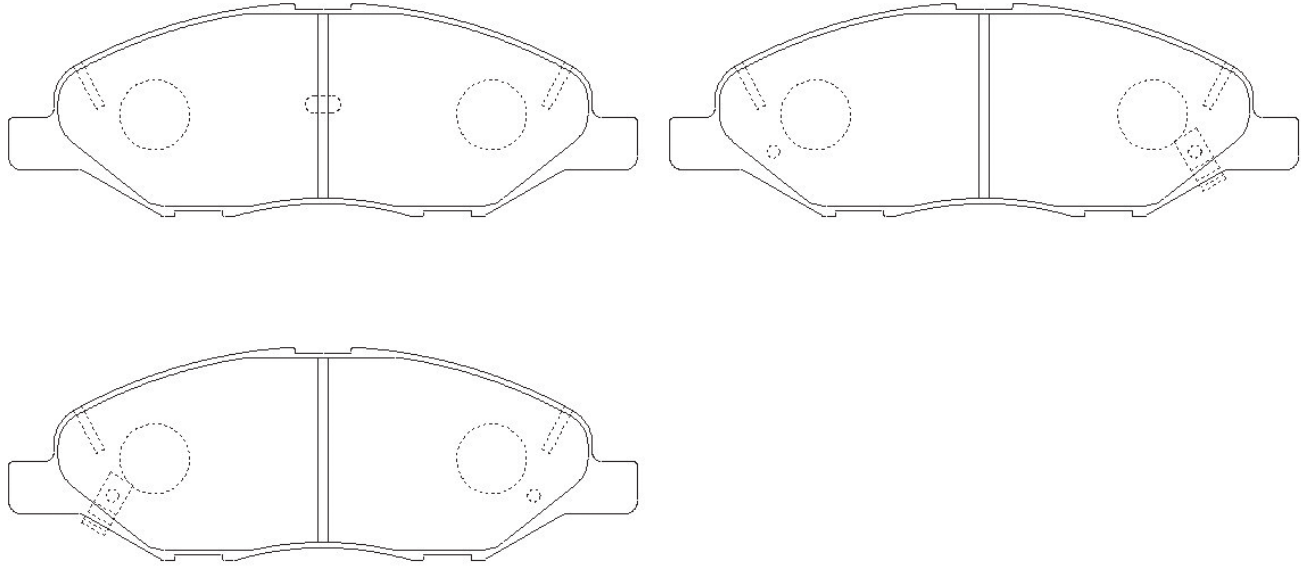

HN-453				92.0		44.3	14.8	AN-607K
				122.0				D6100-02

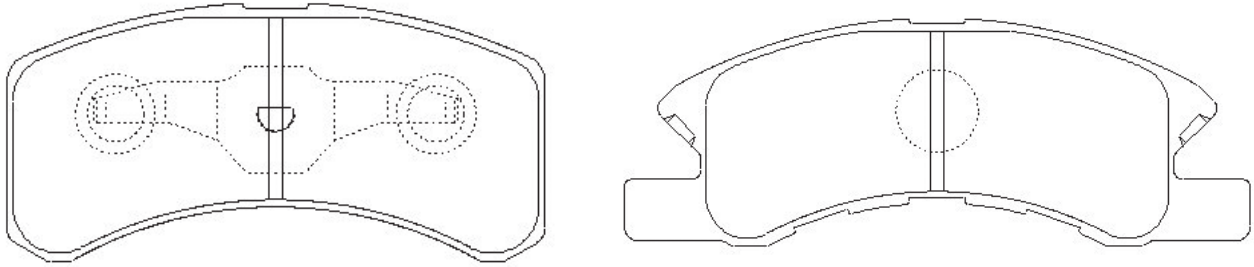

HN-454				78.5		50.8	13.8	AN-635WK
				78.5				D2204M-02

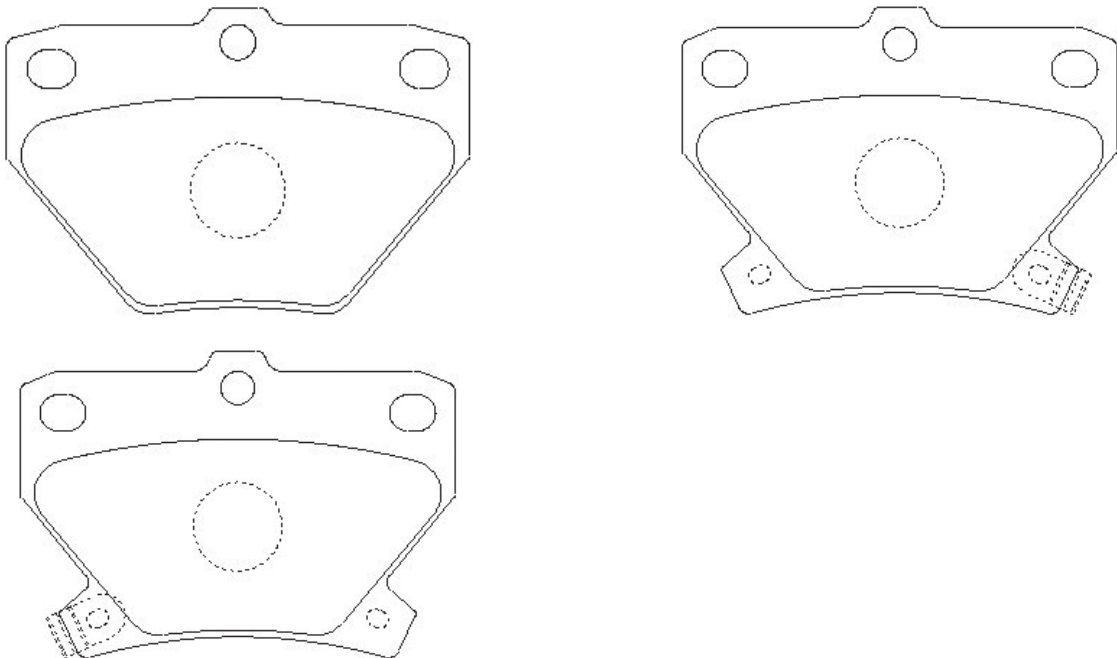

HN-No.	W	H	T	AKNo.	HN-No.	W	H	T	AKNo.
				MKNo.					MKNo.
HN-455	118.5	77.6	15.8	AN-652K	HN-456	96.1	62.0	14.8	AN-653K
				D2212-02					
HN-457	138.8	59.5	18.5	AN-658WK	HN-458	92.9	37.9	14.8	AN-659K
				D2218-02					
HN-459	139.2	59.1	15.8	AN-631K					
				D3110-02					
HN-460						137.0	56.8	16.8	AN-672WK
									D7055M-02

HN-No.	W	H	T	AKNo.	HN-No.	W	H	T	AKNo.
				MKNo.					MKNo.
HN-461						116.6	56.2	15.5	AN-679WK
									D9035M-02

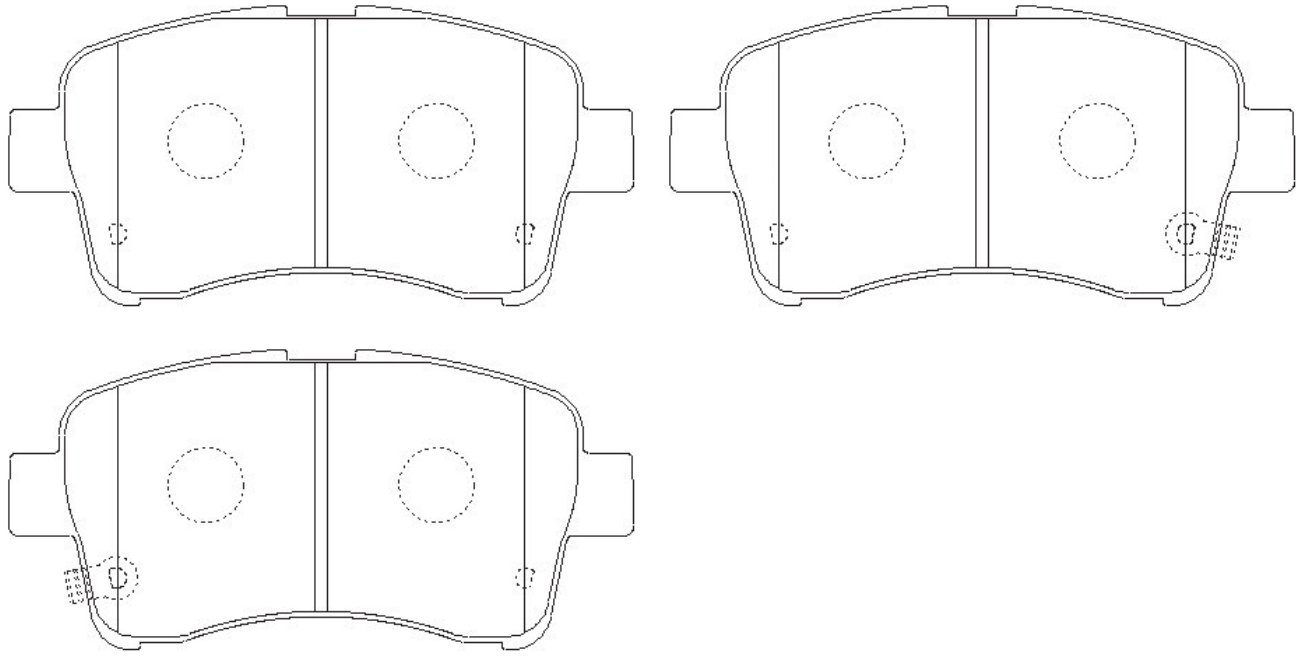

HN-462	114.0	56.5	15.5	AN-641K
				D6109-02

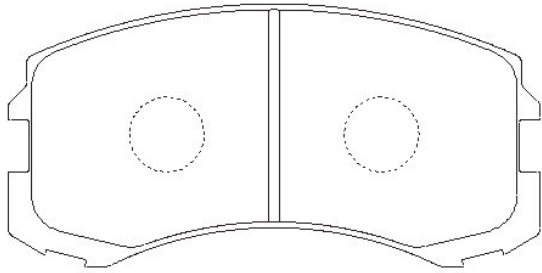

HN-463					119.1	56.8	14.5	AN-615WK
								D7037M-02

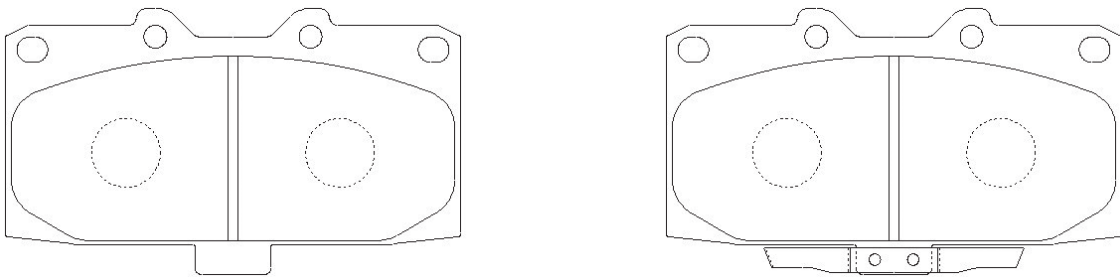

HN-464	206.4	74.6	19.7	AN-617WK
				D4052-02

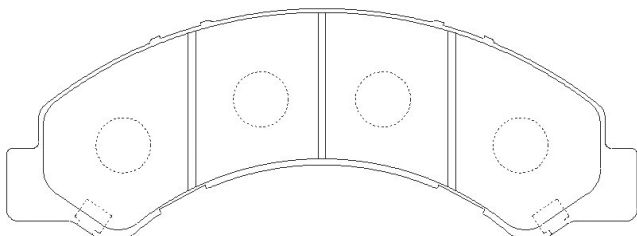

HN-No.	W	H	T	AKNo.	HN-No.	W	H	T	AKNo.
				MKNo.					MKNo.
HN-465						148.7	59.4	15.5	AN-668WK
									D5113M-02

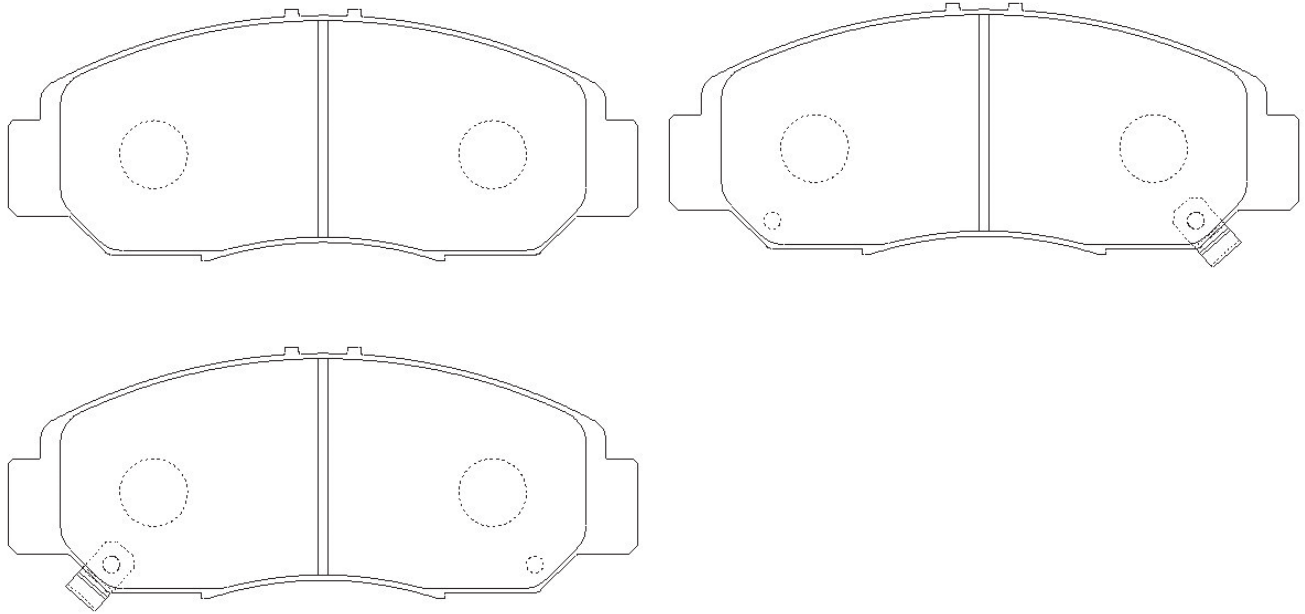

HN-466				105.4		37.8	14.0	AN-654WK
								D1244M-02

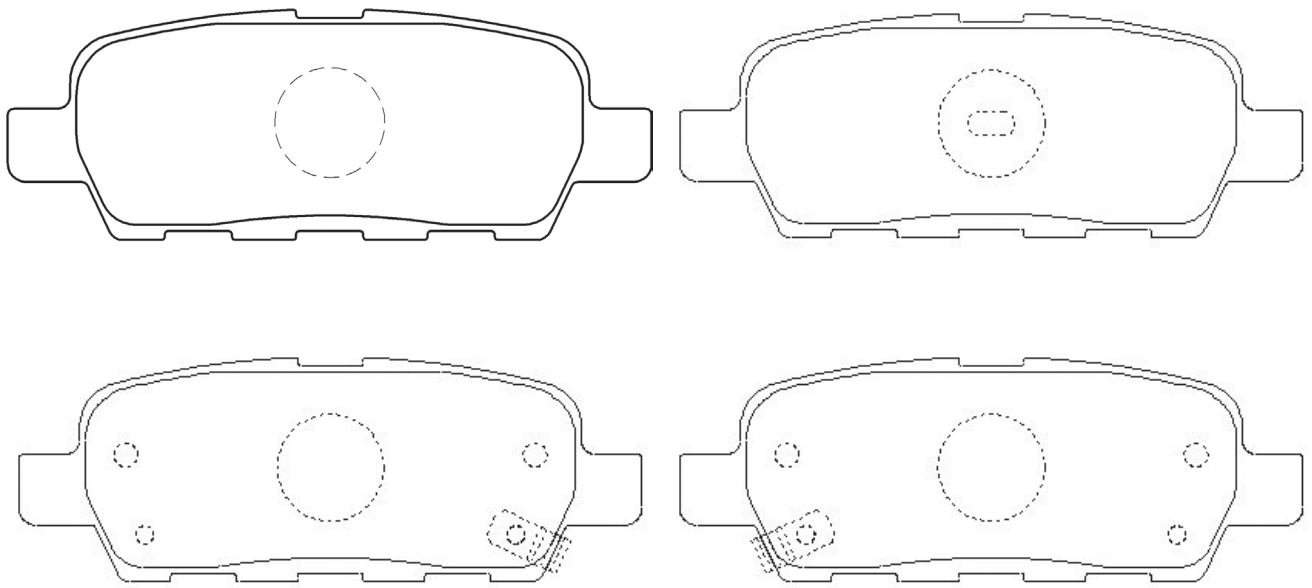

HN-No.	W	H	T	AKNo.	HN-No.	W	H	T	AKNo.
				MKNo.					MKNo.
HN-467						105.4	43.0	15.8	AN-669WK
									D1239M-02

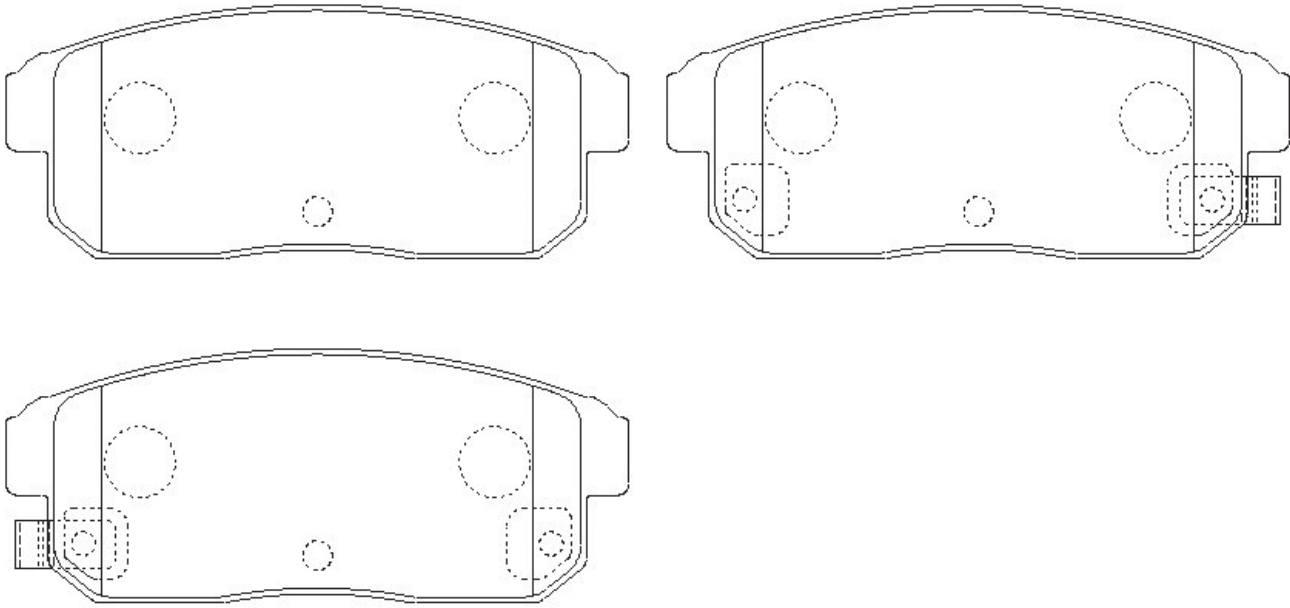

HN-468	W	H	T	AKNo.
	140.1	51.5	17.8	

※1pad w/sensor holes, 3pads w/o sensor holes

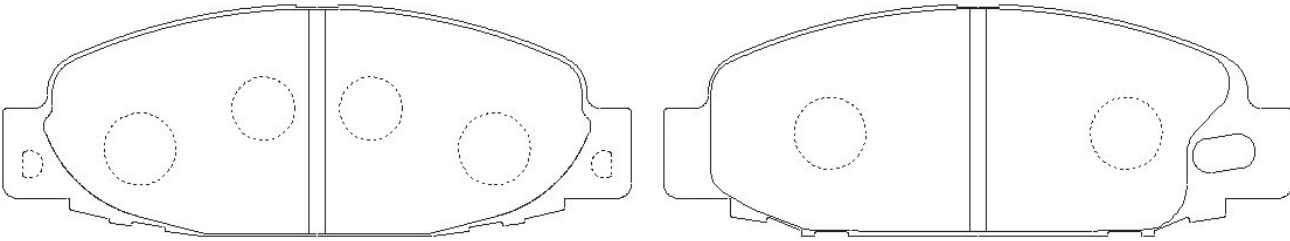

HN-470	W	H	T	AKNo.
	123.0	59.5	16.8	AN-667WK
				D2217-02

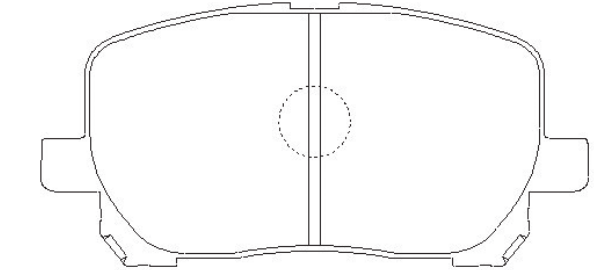

HN-No.	W	H	T	AKNo.	HN-No.	W	H	T	AKNo.
				MKNo.					MKNo.
HN-471						112.5	49.8	16.5	AN-618WK
									D2174M-02

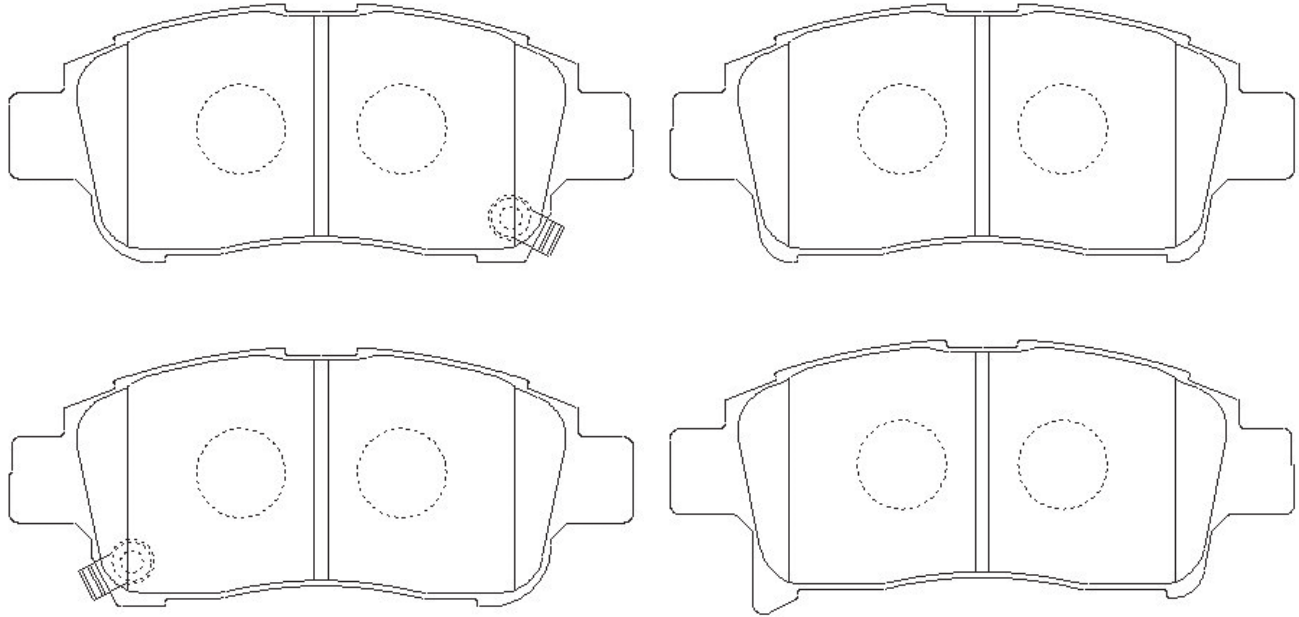

HN-472						116.5	54.5	16.5	AN-634WK
									D2183M-02

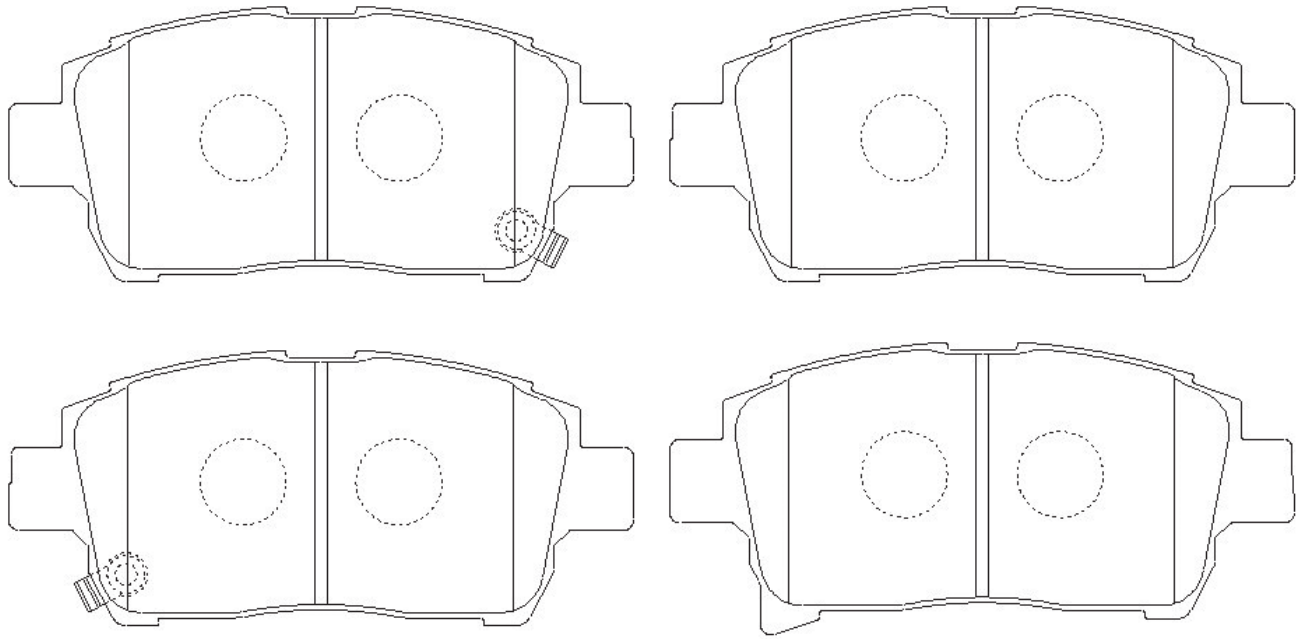

HN-473	110.1	45.8	14.3	AN-623K					
				D6083-02					

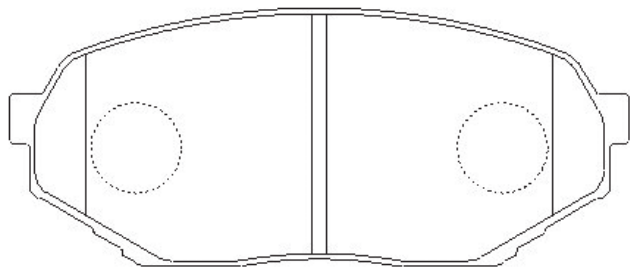

HN-No.	W	H	T	AKNo.	HN-No.	W	H	T	AKNo.
				MKNo.					MKNo.

HN-474						137.0	53.0	16.8	AN-279WK
									D1119M-02

※4pads w/sensor

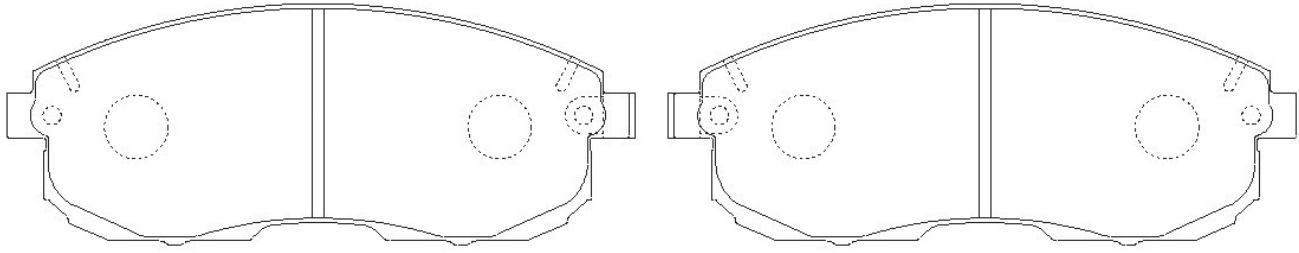

HN-475						168.6	58.2	16.8	AN-665WK
									D1253M-02

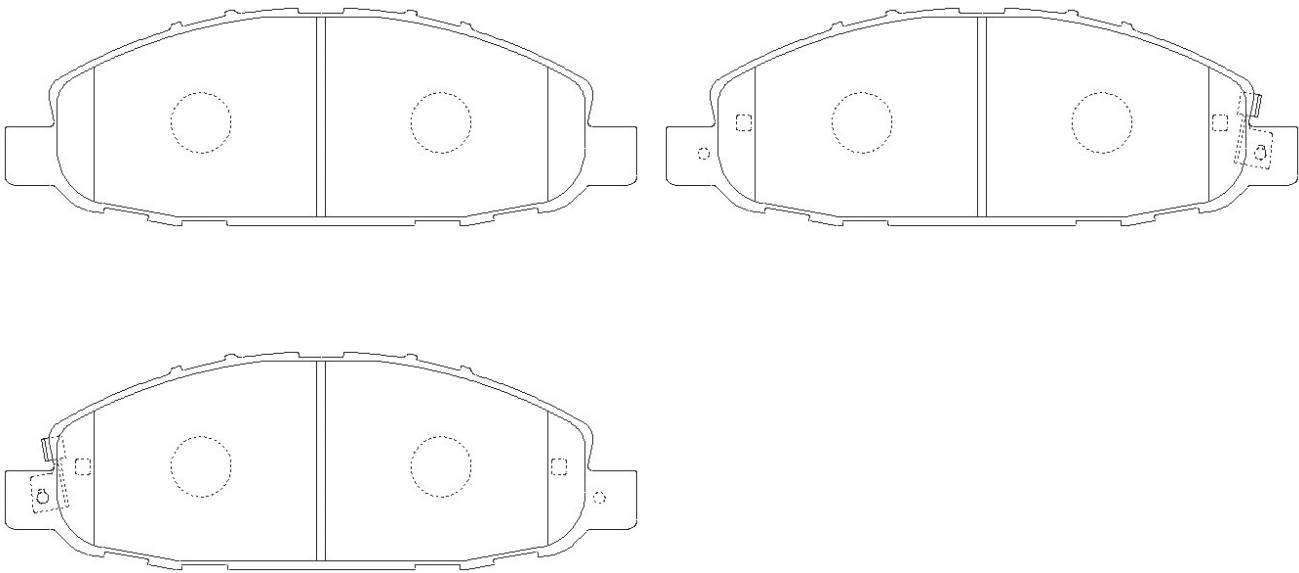

HN-476	100.6	39.0	13.5	AN-645K					
				D3111-02					

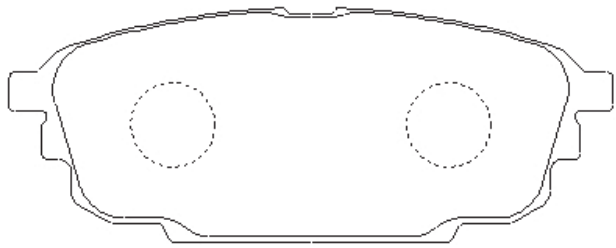

HN-No.	W	H	T	AKNo.	HN-No.	W	H	T	AKNo.
				MKNo.					MKNo.
HN-477						131.1	42.7	14.5	AN-674WK
									D7049M-02

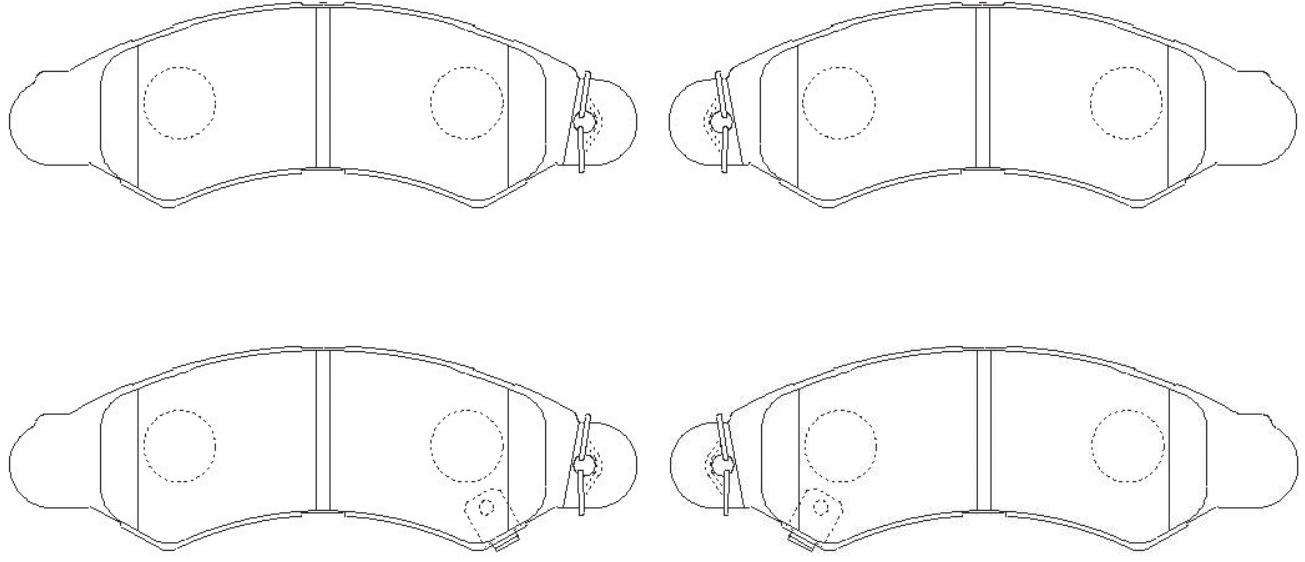

HN-479	131.6	58.5	17.3	AN-671K	HN-480	143.5	58.5	15.8	AN-670K
				D2222-02					D2223-02

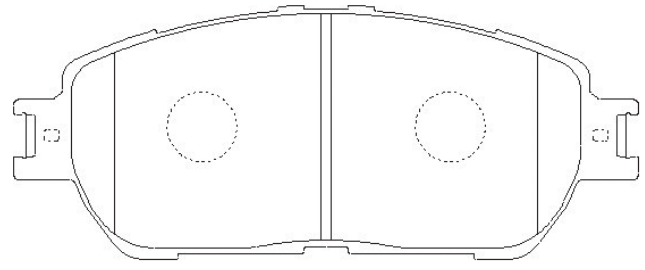
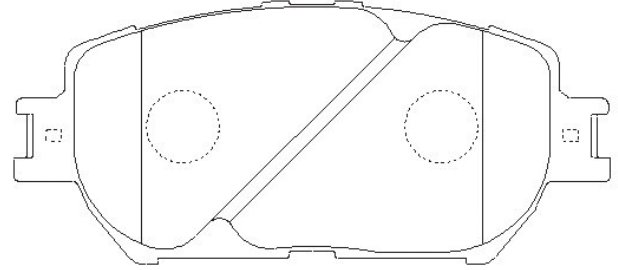

HN-481	114.6	59.5	16.9	AN-678WK					
				D2232-02					

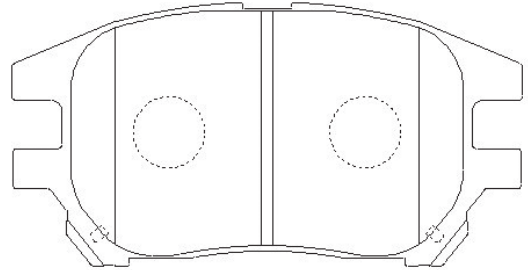

HN-No.	W	H	T	AKNo.	HN-No.	W	H	T	AKNo.
				MKNo.					MKNo.
HN-482						134.5	77.6	16.9	AN-690WK
									D2228M-02

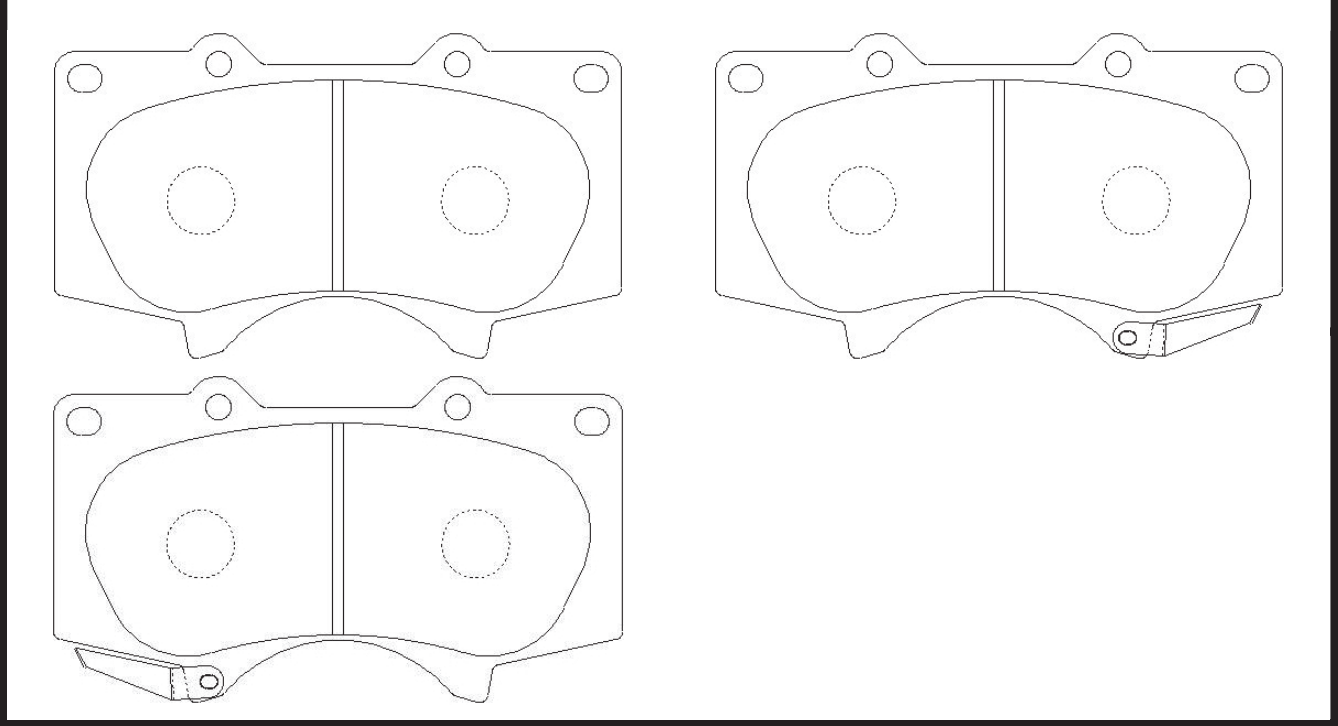

HN-483				131.5		56.1	17.0	AN-680WK
								D3122M-02

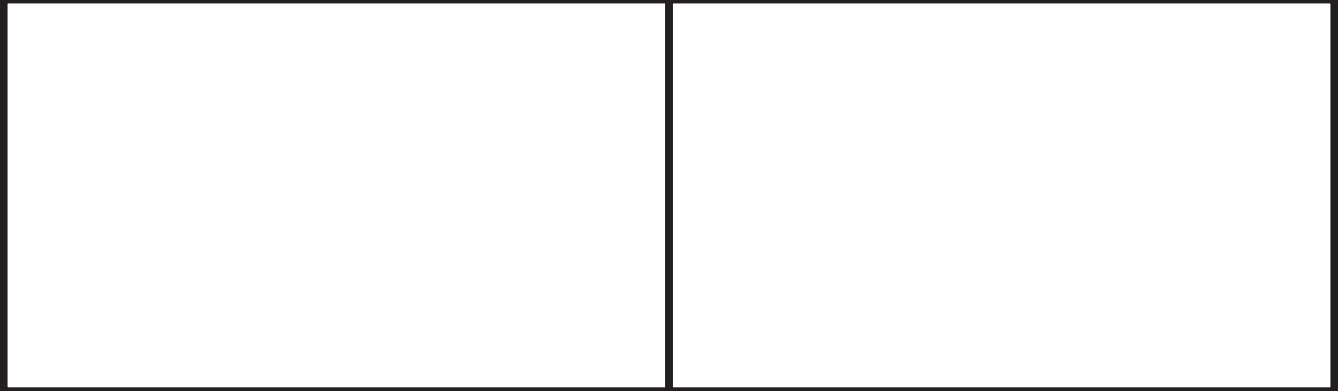
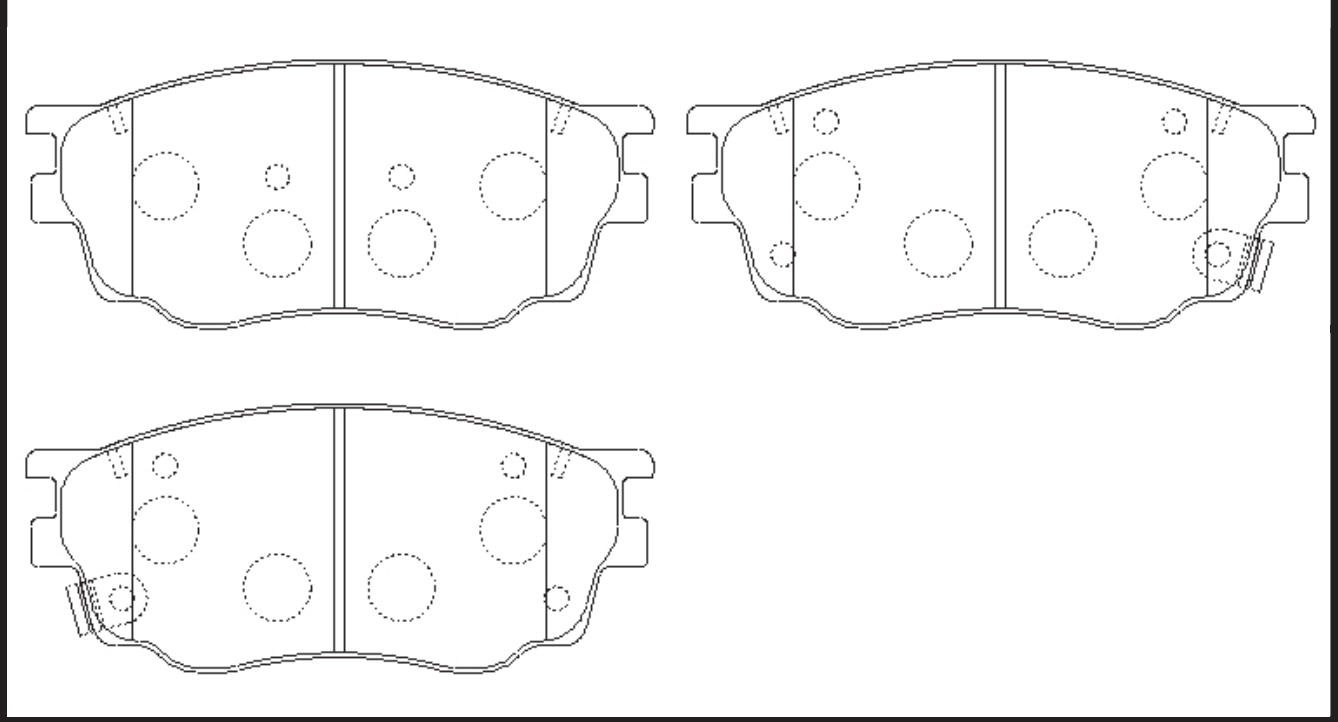

HN-No.	W	H	T	AKNo.	HN-No.	W	H	T	AKNo.
				MKNo.					MKNo.
HN-484						137.8	52.5	16.8	AN-662WK
									D5116M-02

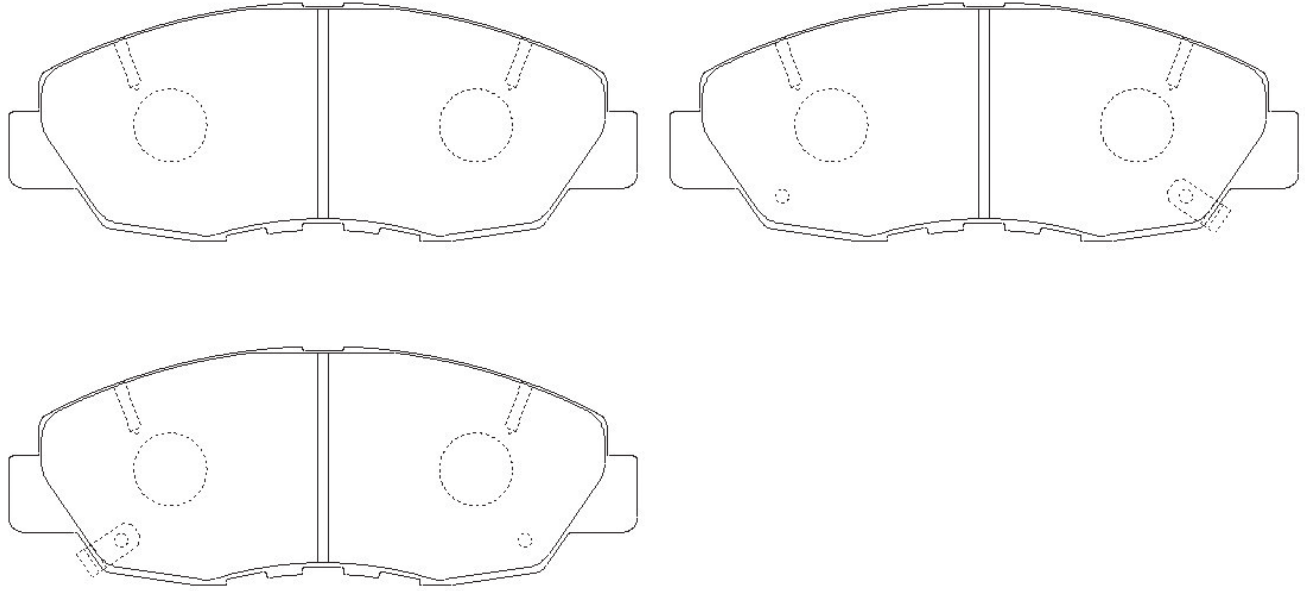

HN-485						141.8	56.6	16.8	AN-663WK
									D5128M-02

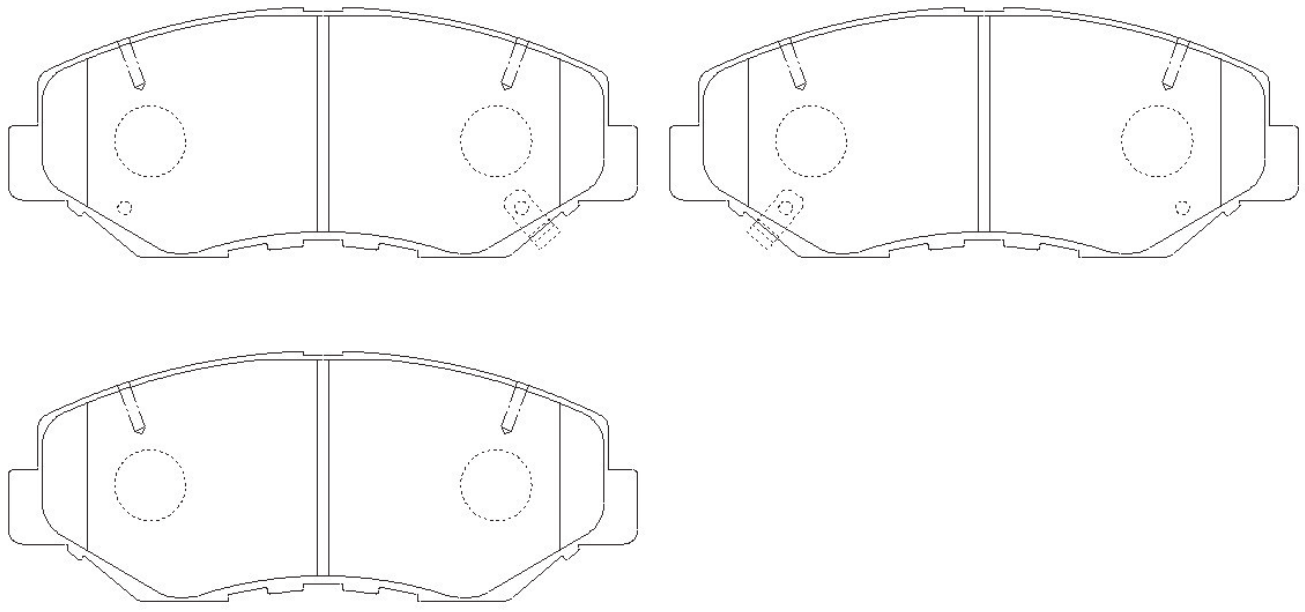

HN-486	123.0	58.3	15.3	AN-646K					
				D3116-02					

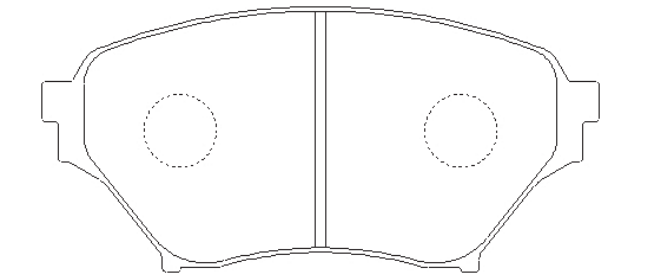

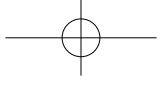

HN-No.	W	H	T	AKNo.	HN-No.	W	H	T	AKNo.
				MKNo.					MKNo.

HN-487				102.0	42.6	12.4	AN-647WK
							D3117M-02

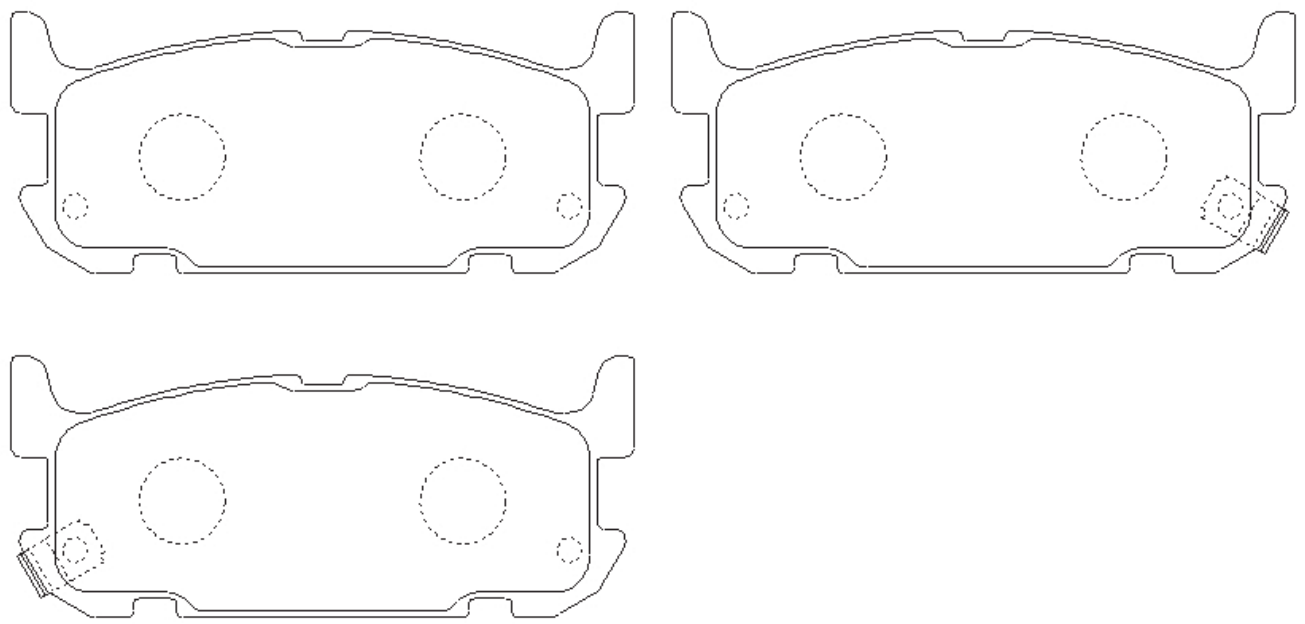

HN-488				158.8	56.0	14.8	AN-677WK
							D1248M-02

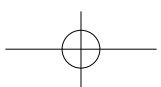
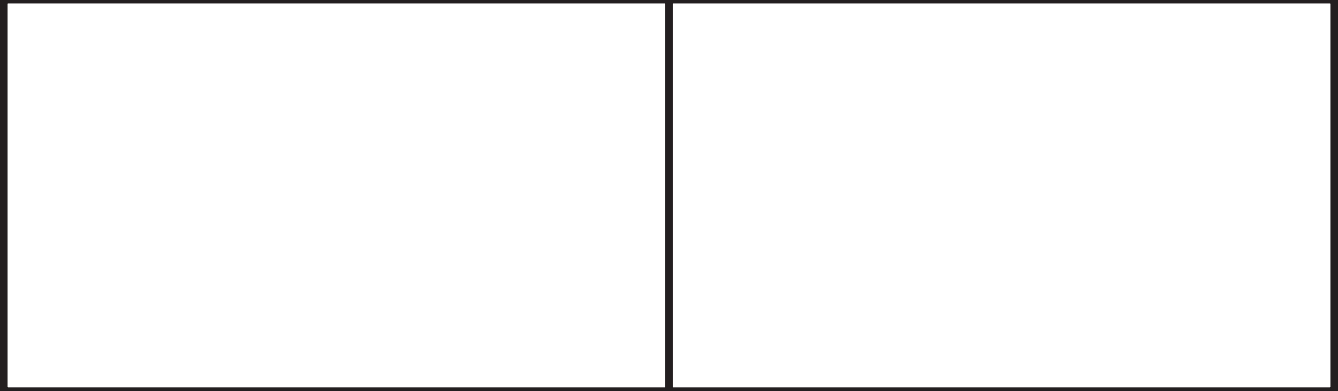
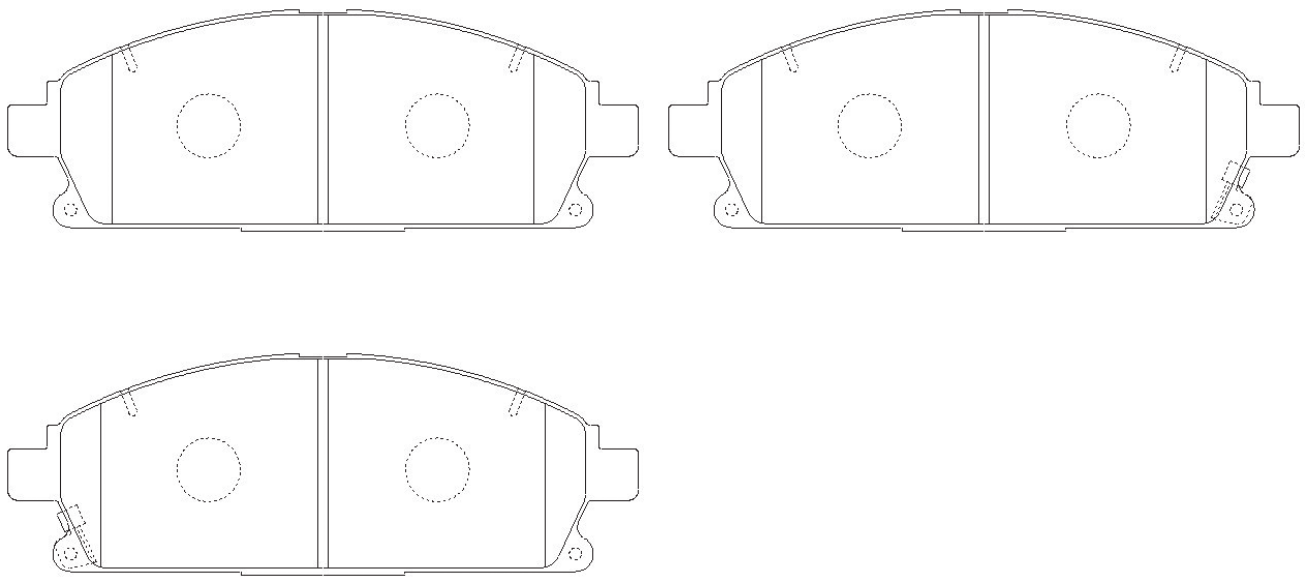

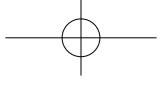

HN-No.	W	H	T	AKNo.	HN-No.	W	H	T	AKNo.
				MKNo.					MKNo.
HN-489						170.8	71.8	19.8	AN-648WK
									D4049M-02

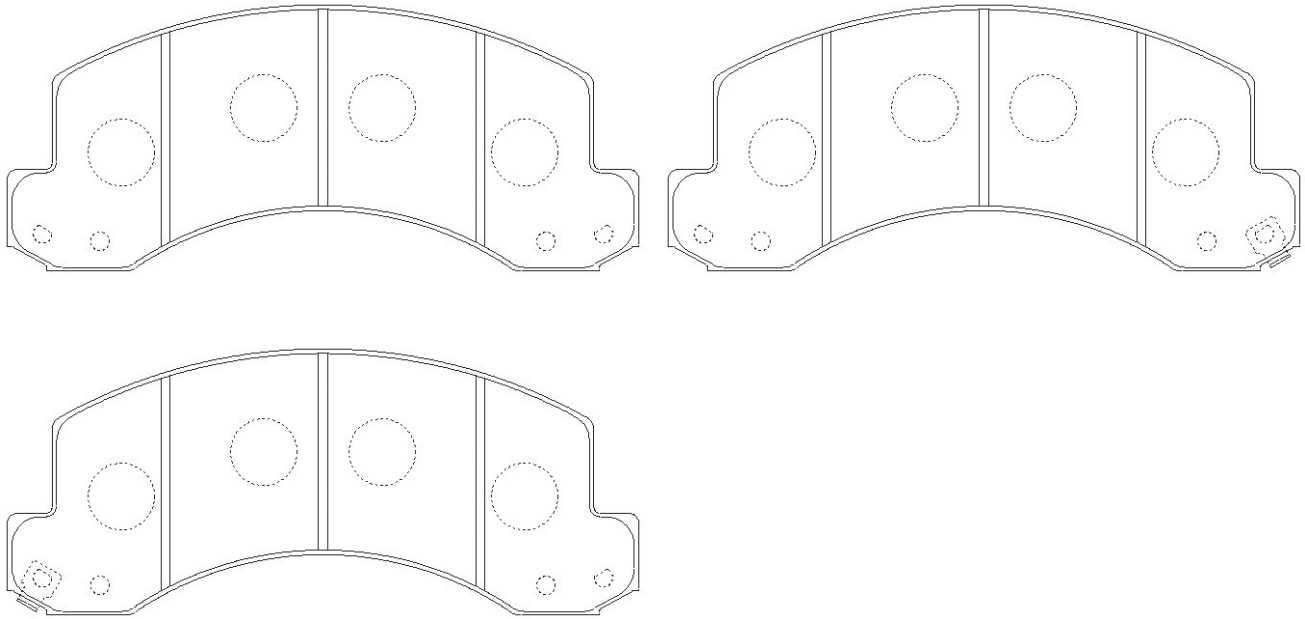

HN-490	W	H	T	AKNo.	HN-No.	W	H	T	AKNo.
				MKNo.					MKNo.
HN-490						176.9	54.5	16.5	

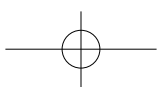
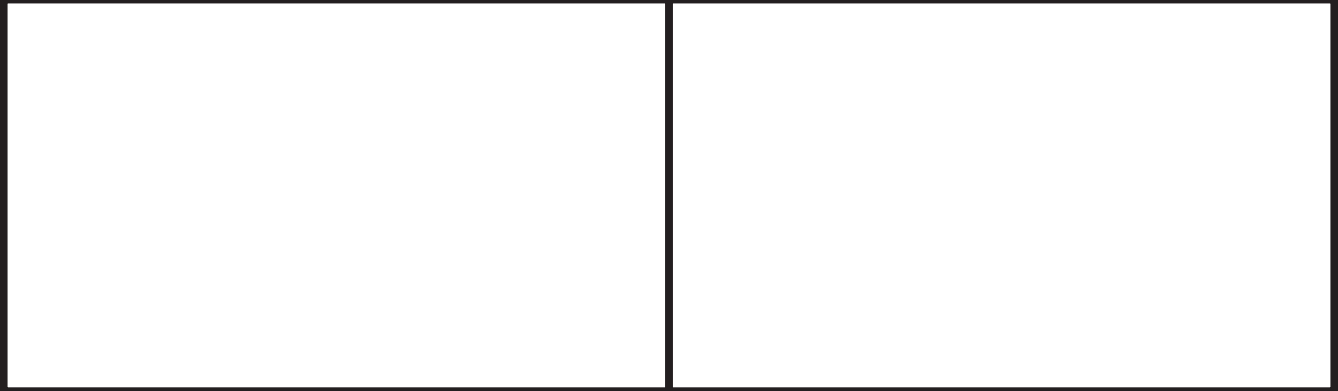
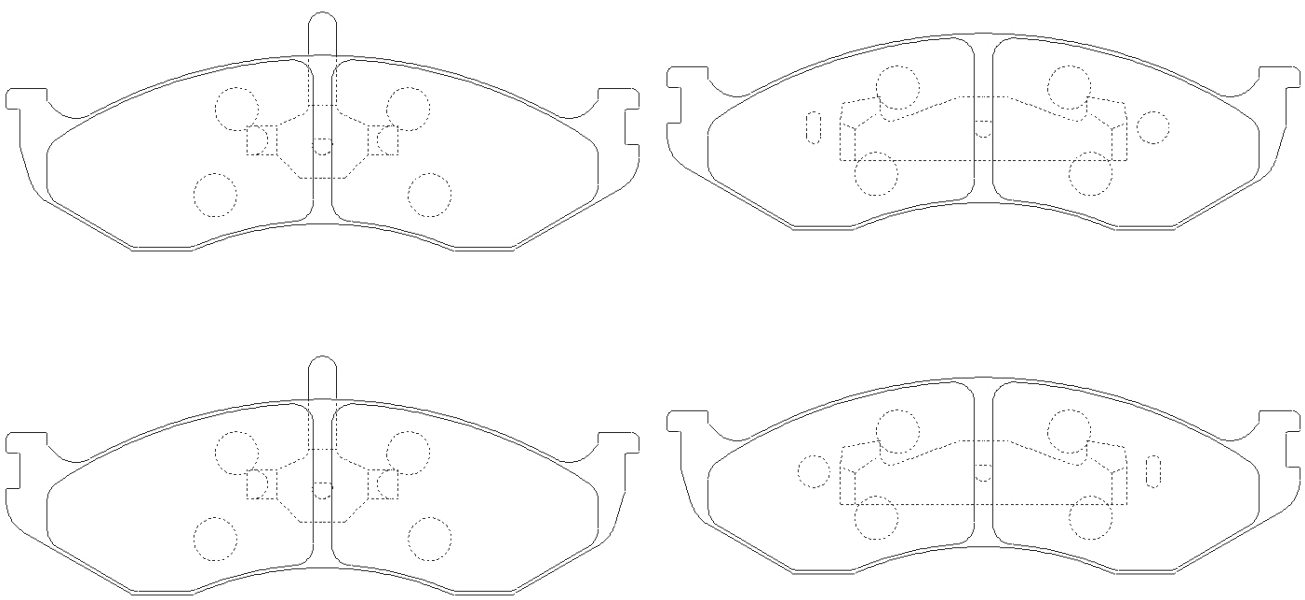

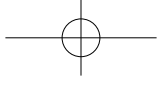

HN-No.	W	H	T	AKNo.	HN-No.	W	H	T	AKNo.
				MKNo.					MKNo.
HN-491						206.4	79.7	19.8	AN-656WK
									D4053-02

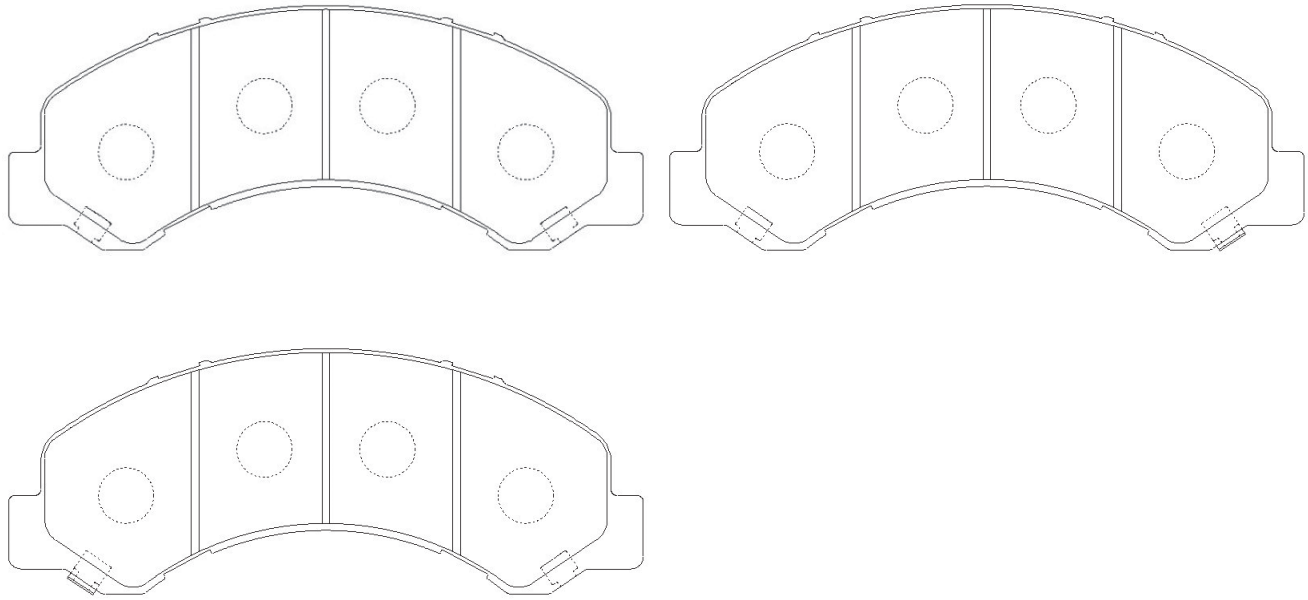

HN-492				108.5		45.4	14.3	AN-683WK
								D0045M-02

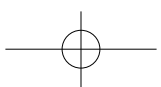
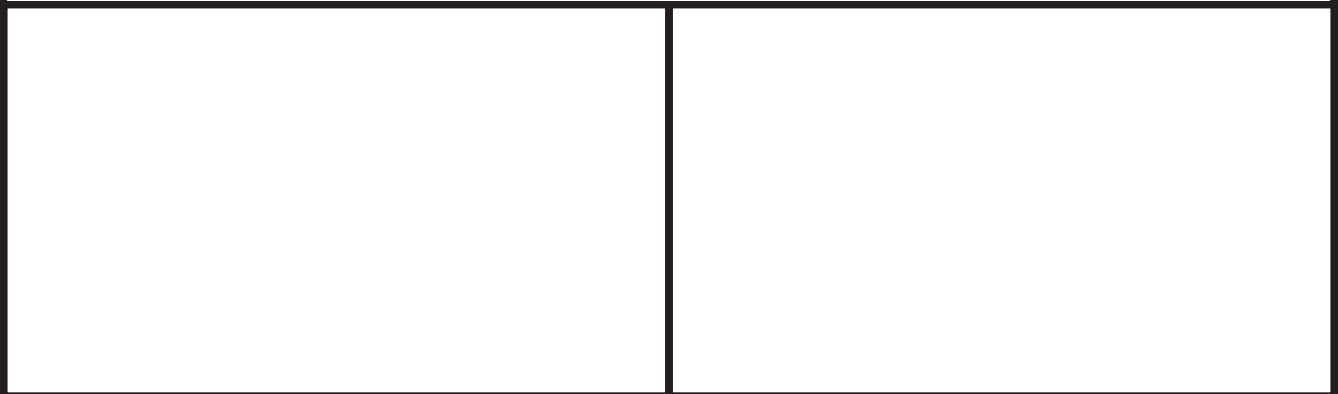
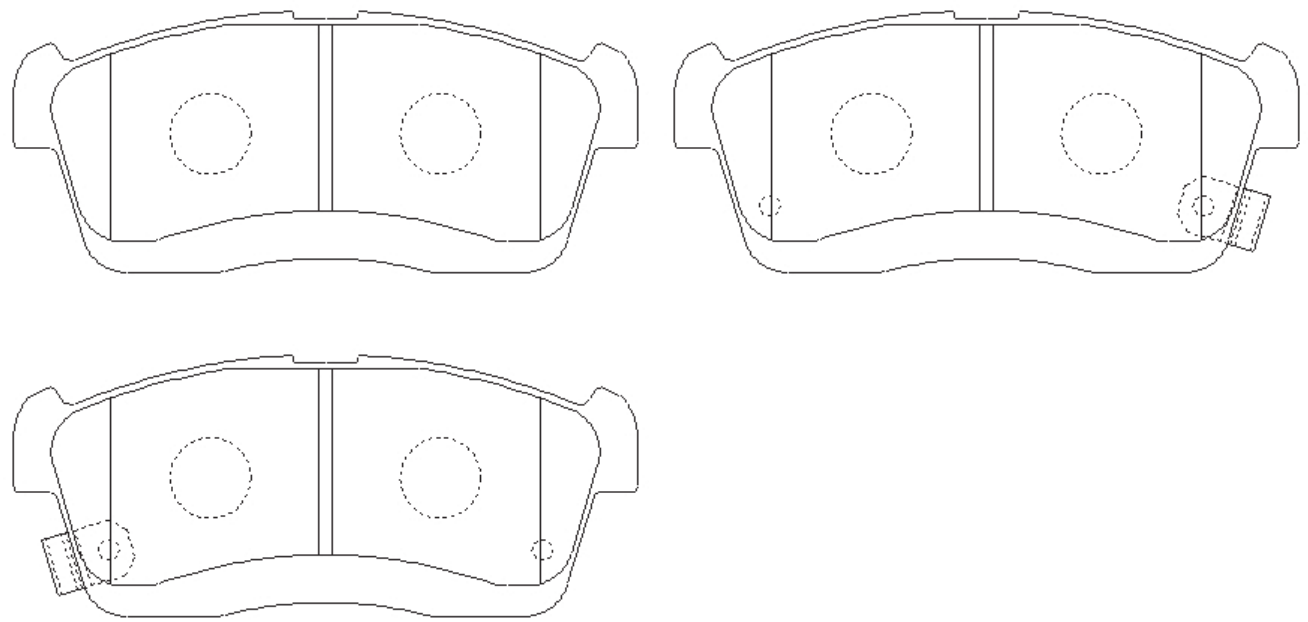

HN-No.	W	H	T	AKNo.	HN-No.	W	H	T	AKNo.
				MKNo.					MKNo.
HN-493						137.0	53.5	16.8	AN-691WK
									D7058-02

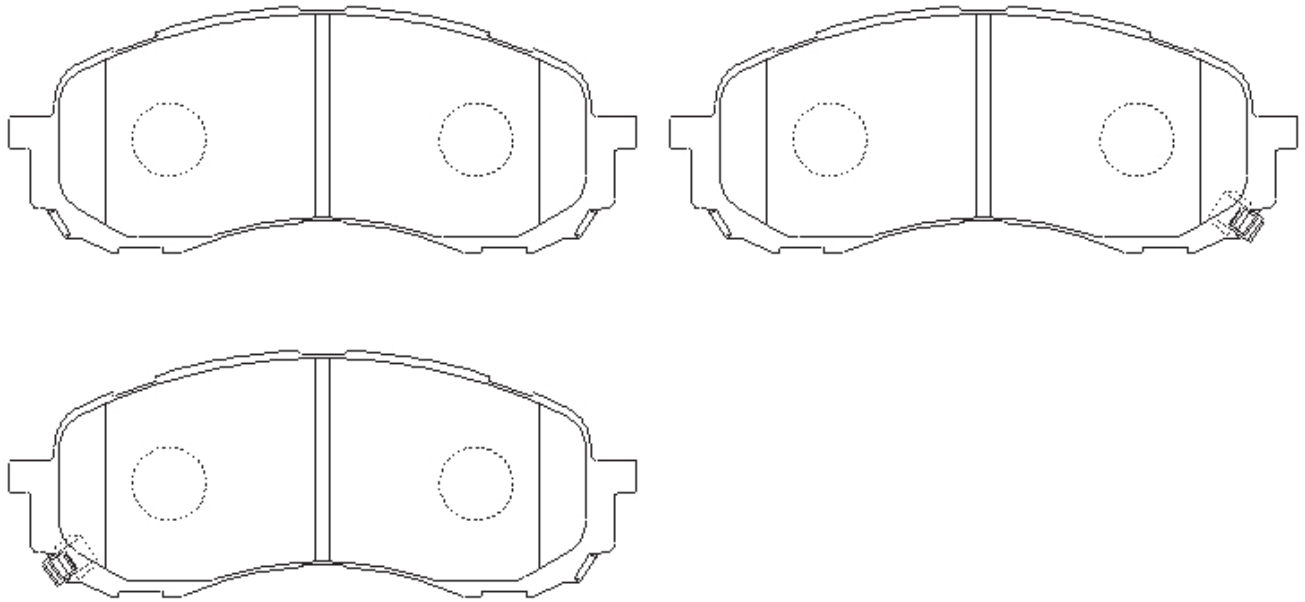

HN-494	88.0	58.2	15.5	AN-699WK
				D2243M-02

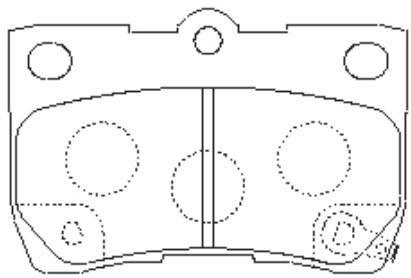

HN-495	151.4	58.0	18.3	AN-686K
		150.2	61.4	18.3

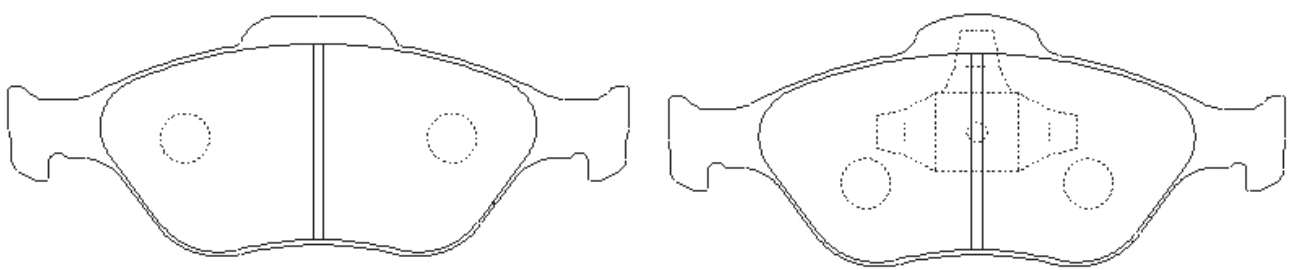

HN-No.	W	H	T	AKNo.	HN-No.	W	H	T	AKNo.
				MKNo.					MKNo.
HN-496									AN-321WK
									D2099M-02

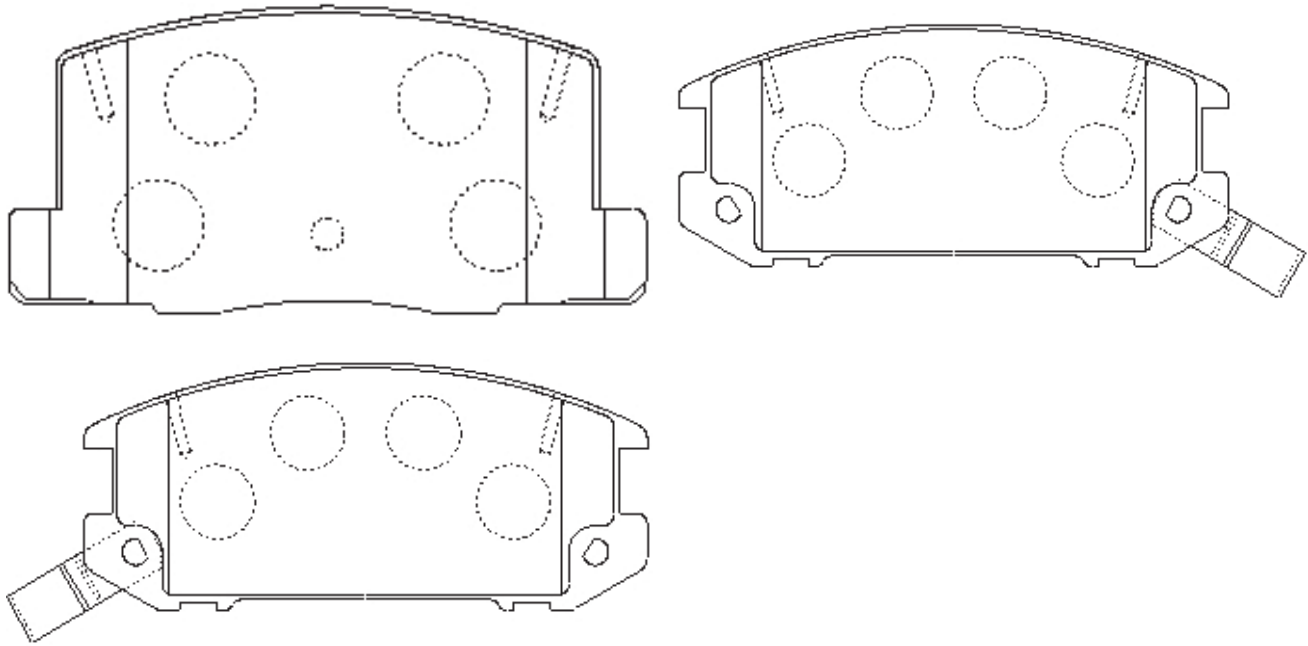

HN-497	140.8	59.0	16.8	AN-687WK
				D2249-02

HN-498	101.8	43.8	15.3	AN-688WK
				D2250-02

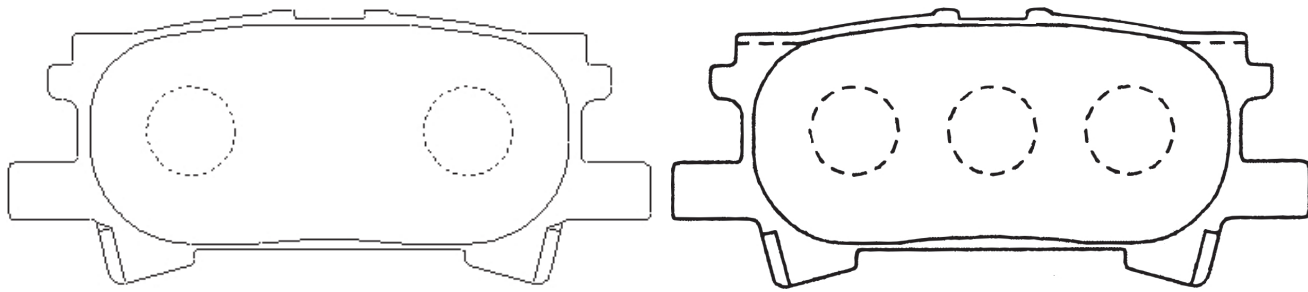

HN-No.	W	H	T	AKNo.	HN-No.	W	H	T	AKNo.
				MKNo.					MKNo.
HN-499						157.0	63.5	16.8	AN-703WK
									D7060M-02

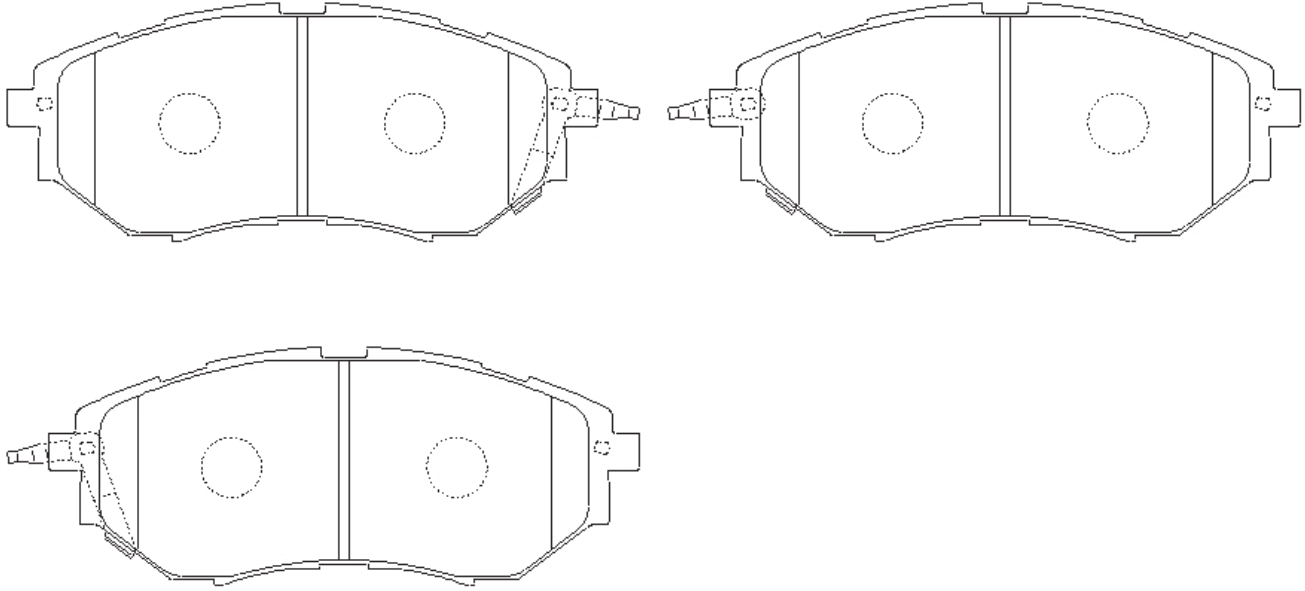

HN-500				121.9	51.5	15.3	AN-660WK
				94.0	50.0	15.3	D6121-02

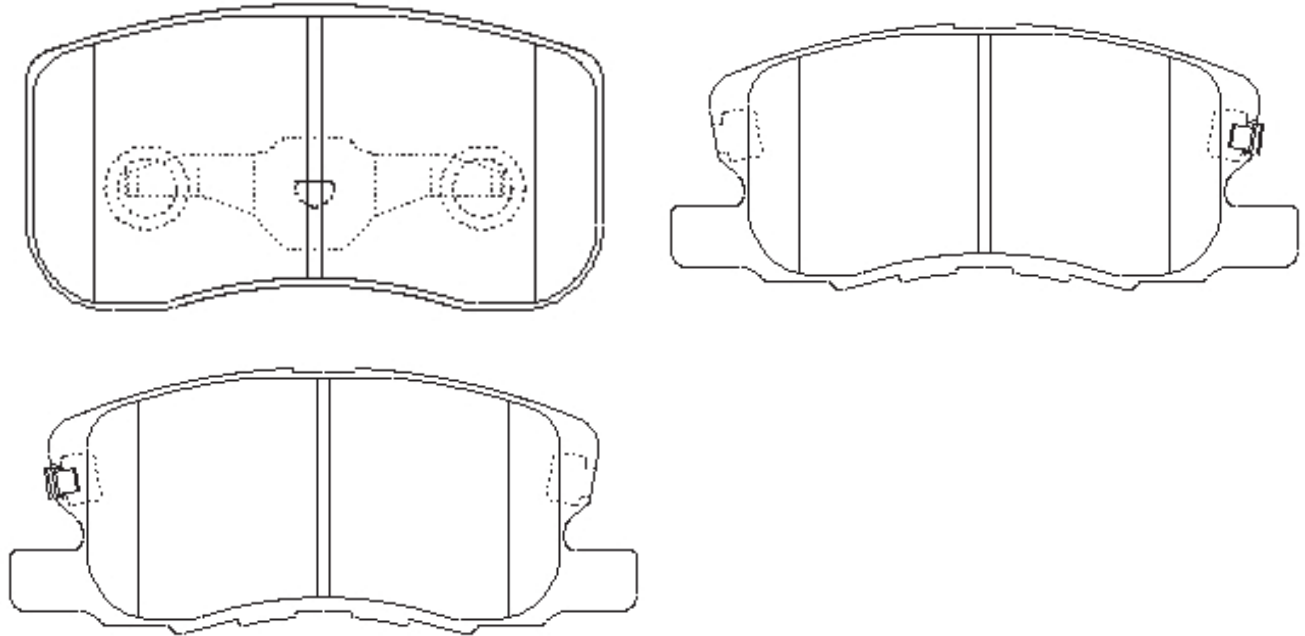

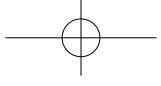

HN-No.	W	H	T	AKNo.	HN-No.	W	H	T	AKNo.
				MKNo.					MKNo.
HN-501						110.3	37.5	13.8	AN-696WK
									D7064M-02

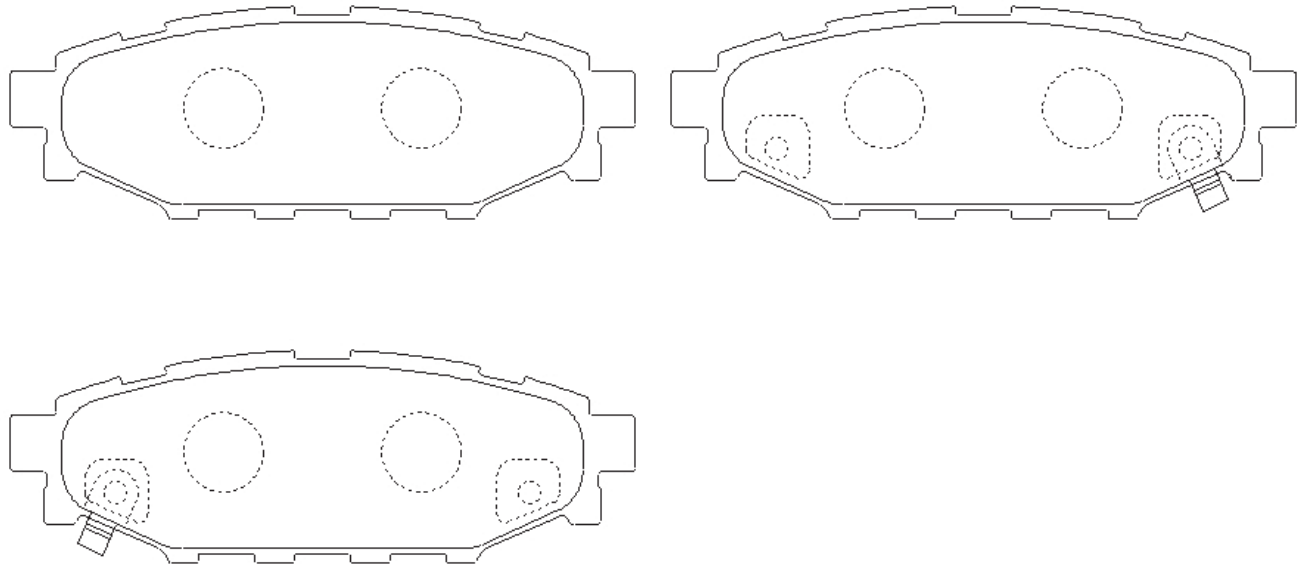

HN-502				105.9		35.3		15.3	AN-651WK
				85.5		39.2		15.3	D6124-02

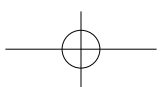
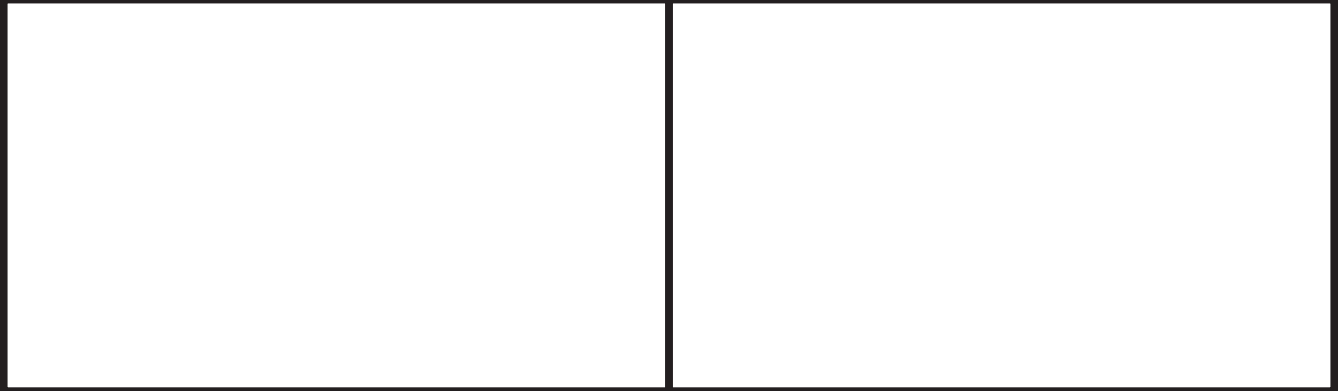
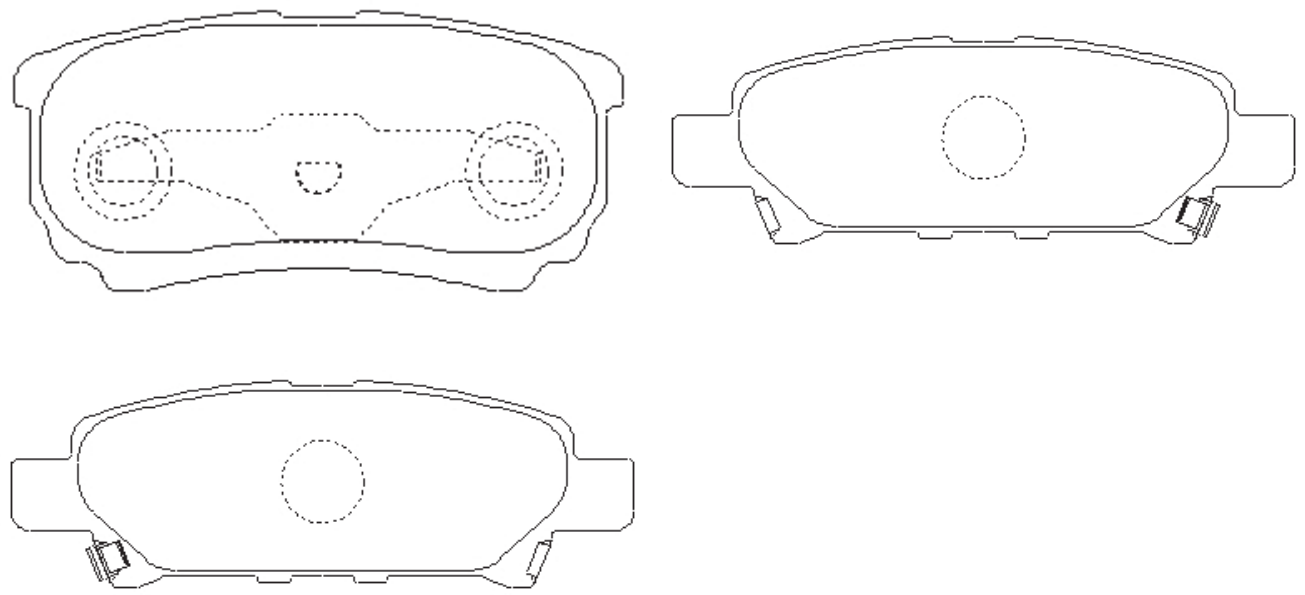

HN-No.	W	H	T	AKNo.	HN-No.	W	H	T	AKNo.
				MKNo.					MKNo.
HN-503									AN-722WK
									D2201M-02

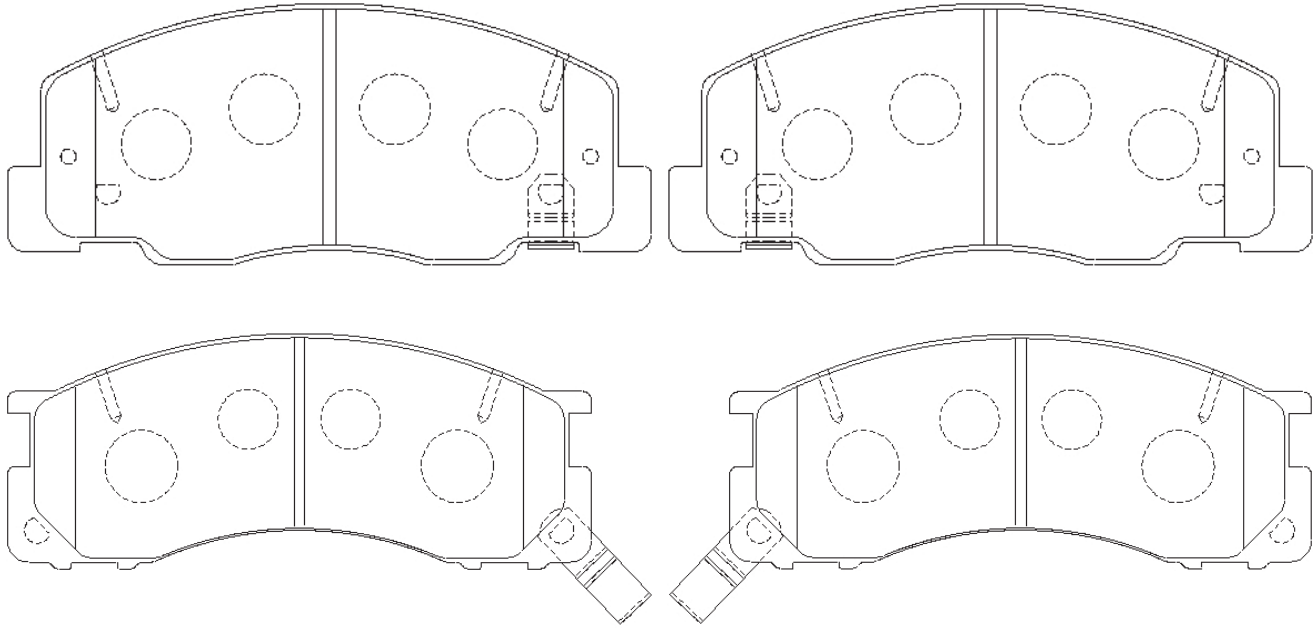

HN-504	137.0	53.0	15.3	AN-673WK	HN-505	137.0	53.0	15.3	AN-689WK
				D1241M-02					

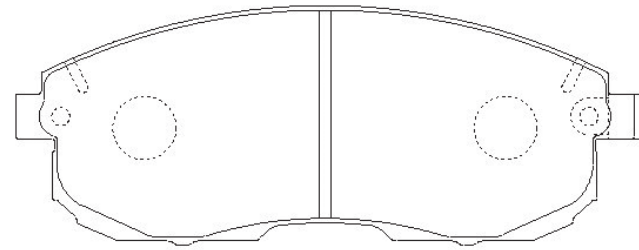

※4pads w/sensor

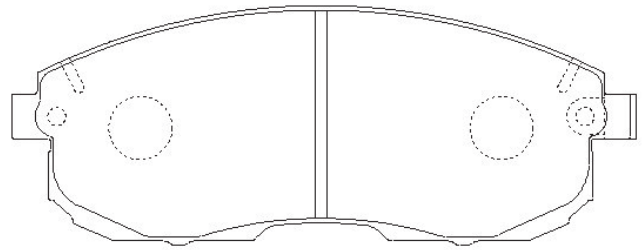

HN-506									AN-698WK
									D5137M-02

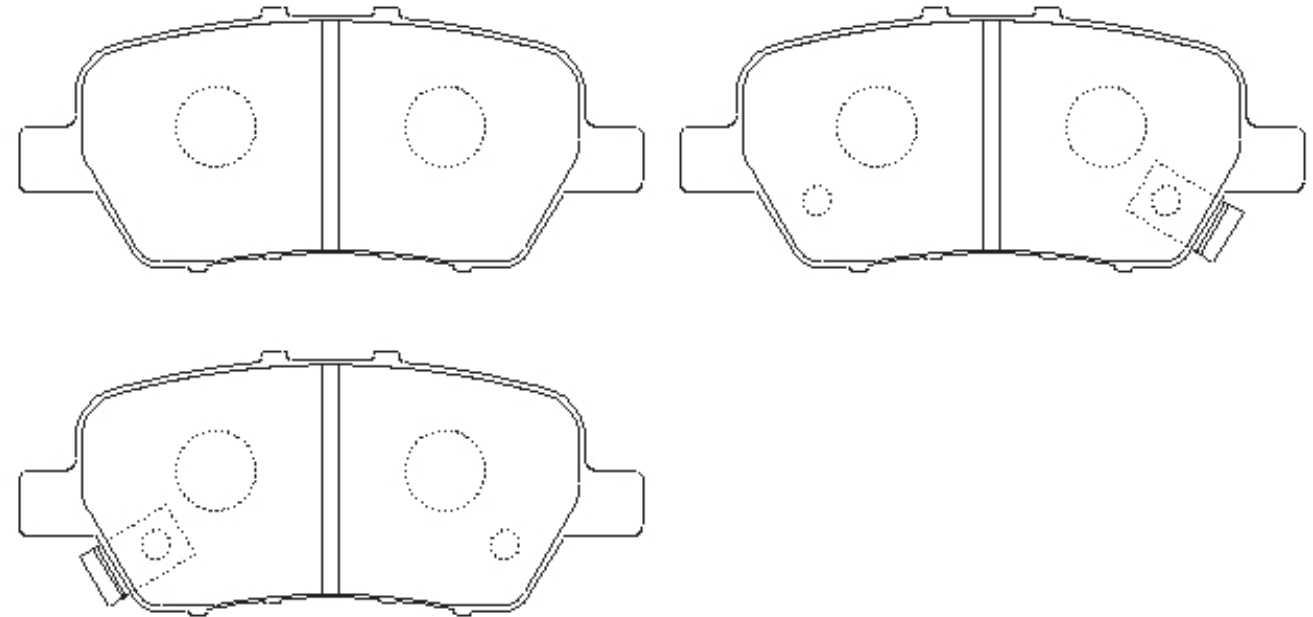

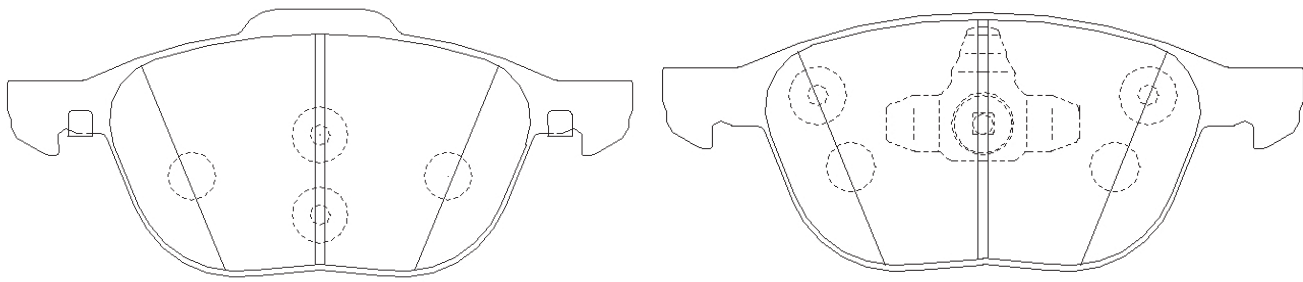
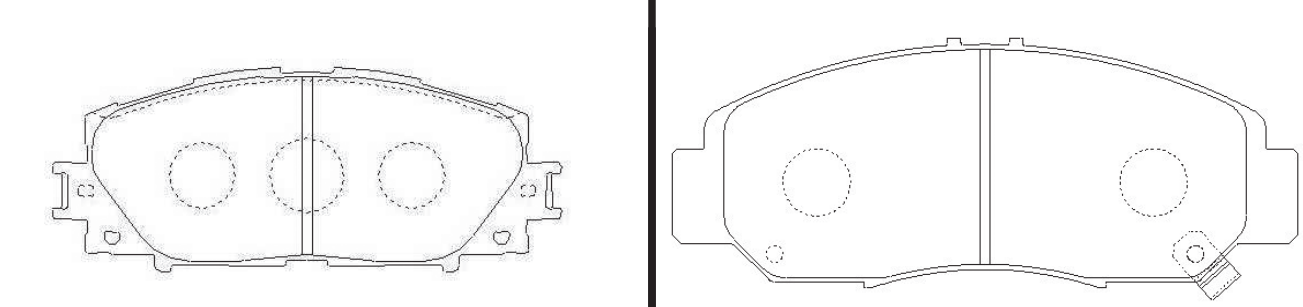
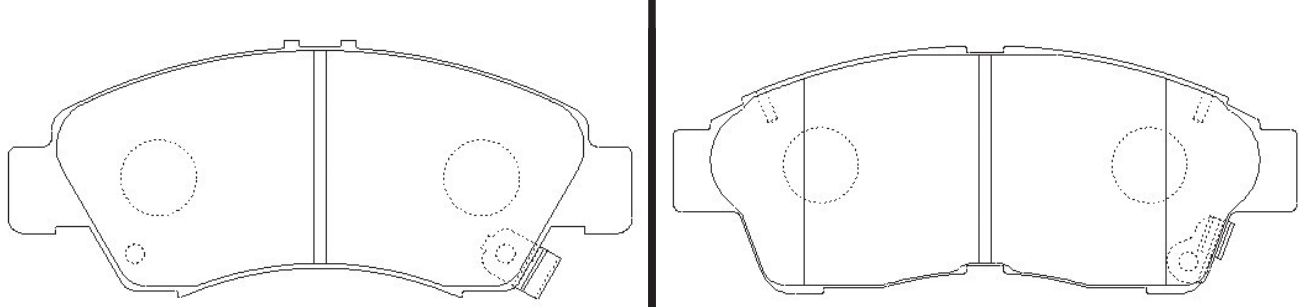
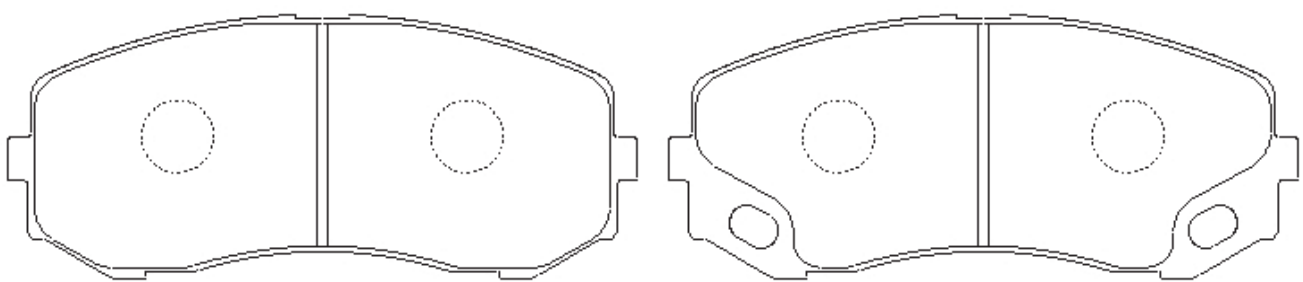
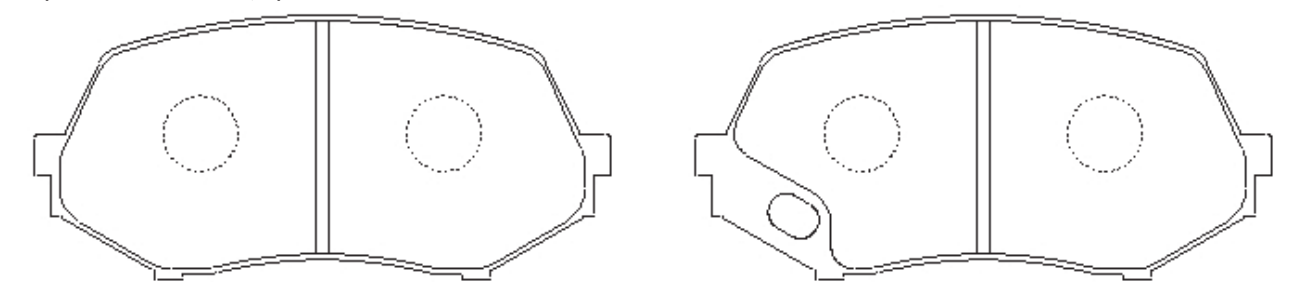
HN-No.	W	H	T	AKNo.	HN-No.	W	H	T	AKNo.		
				MKNo.					MKNo.		
HN-507						156.4	66.3	17.3	AN-717K		
									D3128-02		
											
HN-508	123.5	49.5	17.3	AN-714K	HN-509	148.7	59.4	16.8	AN-668WK		
				D2252-02					D5122M-02		
											
HN-510	131.3	54.2	14.6	AN-377WK	HN-511	133.0	53.0	17.5	AN-394WK		
				D5073M-02					D2118M-02		
											
HN-513								139.0	59.0	19.3	AN-700K
											D6115-02
<p>※2pads w/sensor holes, 6pads w/o sensor holes</p> 											
HN-514								123.0	56.5	17.3	AN-701WK
											D6113-02
<p>※1pad w/sensor holes, 7pads w/o sensor holes</p> 											

HN-No.	W	H	T	AKNo.	HN-No.	W	H	T	AKNo.
				MKNo.					MKNo.

HN-515						147.1	56.0	17.8	AN-682K
									D6118-02

※1pad w/sensor holes, 3pads w/o sensor holes

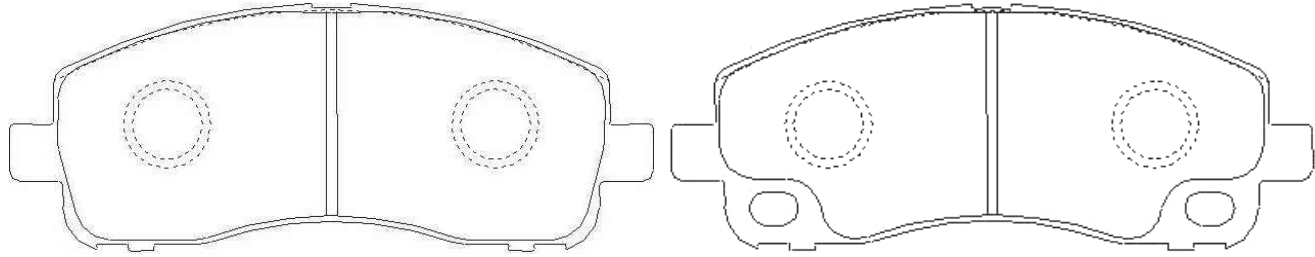

HN-516	145.4	55.5	15.3	AN-707K					
				D2251-02					

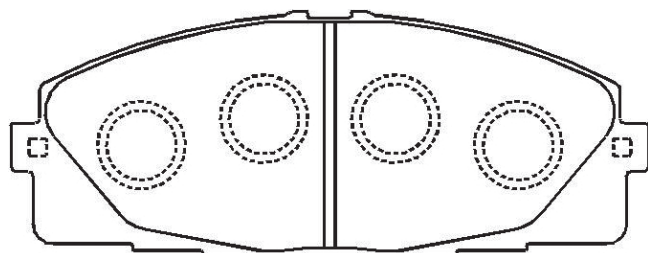

HN-517					163.6	54.0	15.3	AN-726WK
								D1267M-02

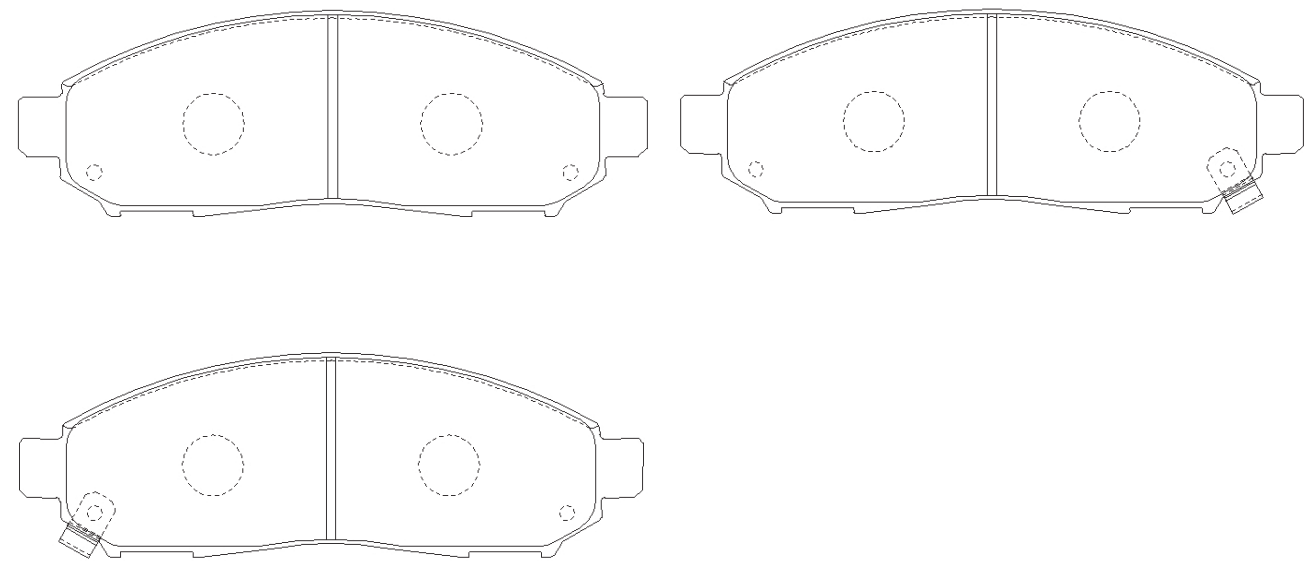

HN-518	123.5	54.3	17.3	AN-715K					
				D2253-02					

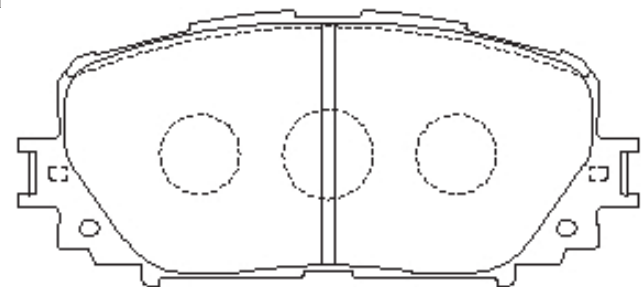

HN-No.	W	H	T	AKNo.	HN-No.	W	H	T	AKNo.
				MKNo.					MKNo.
HN-519						98.5	43.0	14.8	AN-716WK
									D2254M-02

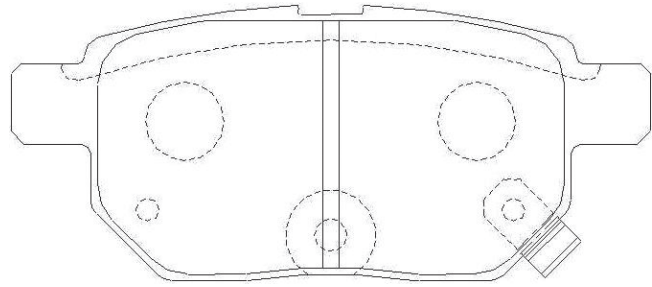
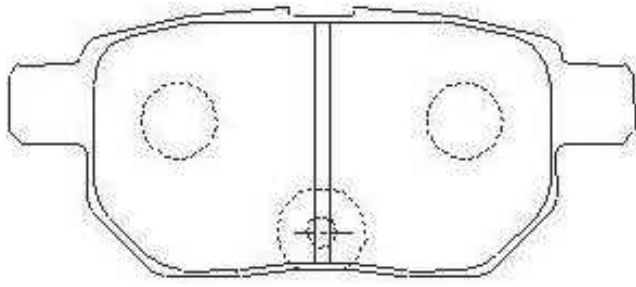

HN-520						78.8	58.2	14.4	AN-725WK
									D0038M-02

※Integrated into HN-512

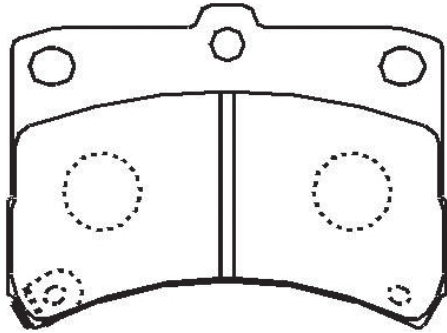
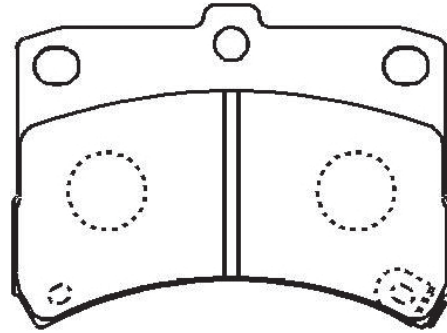
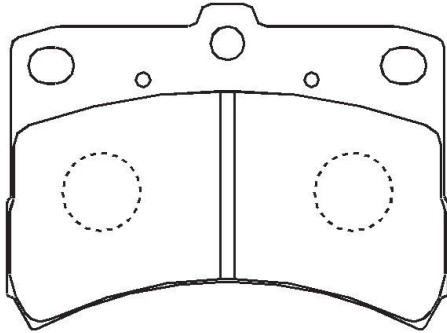

HN-521	157.6	57.0	17.4	AN-734K	HN-522	96.7	49.2	15.4	AN-733K
				D2270-02					D2269-02

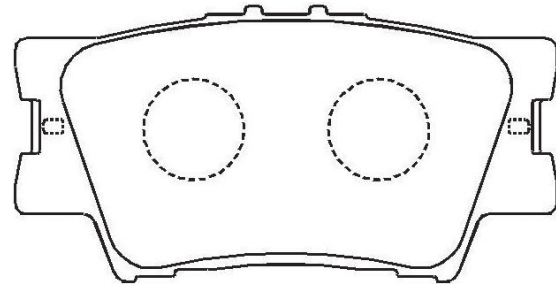
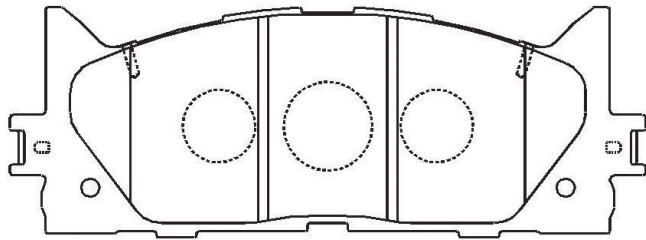

HN-523	108.5	41.9	14.6	AN-727K	HN-524	139.0	55.5	17.3	AN-742K
				D9041-02					D2274-02

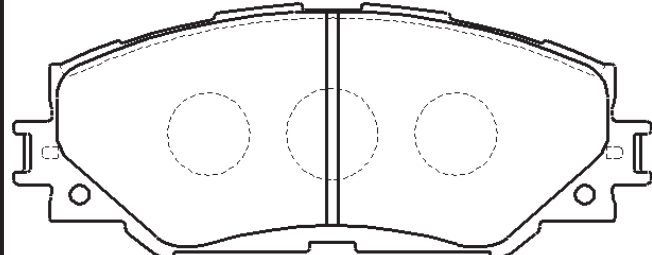
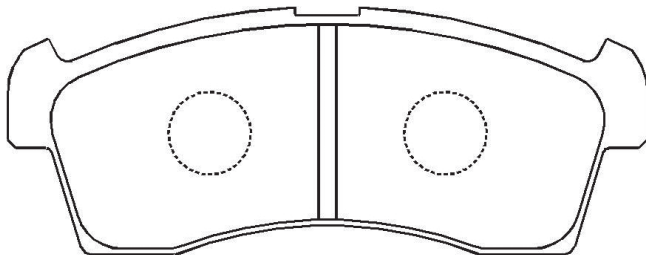

HN-No.	W	H	T	AKNo.	HN-No.	W	H	T	AKNo.
				MKNo.					MKNo.

HN-525						111.0	43.0	14.5	AN-728WK
									D7066M-02

※1pad w/sensor, 3pads w/o sensor

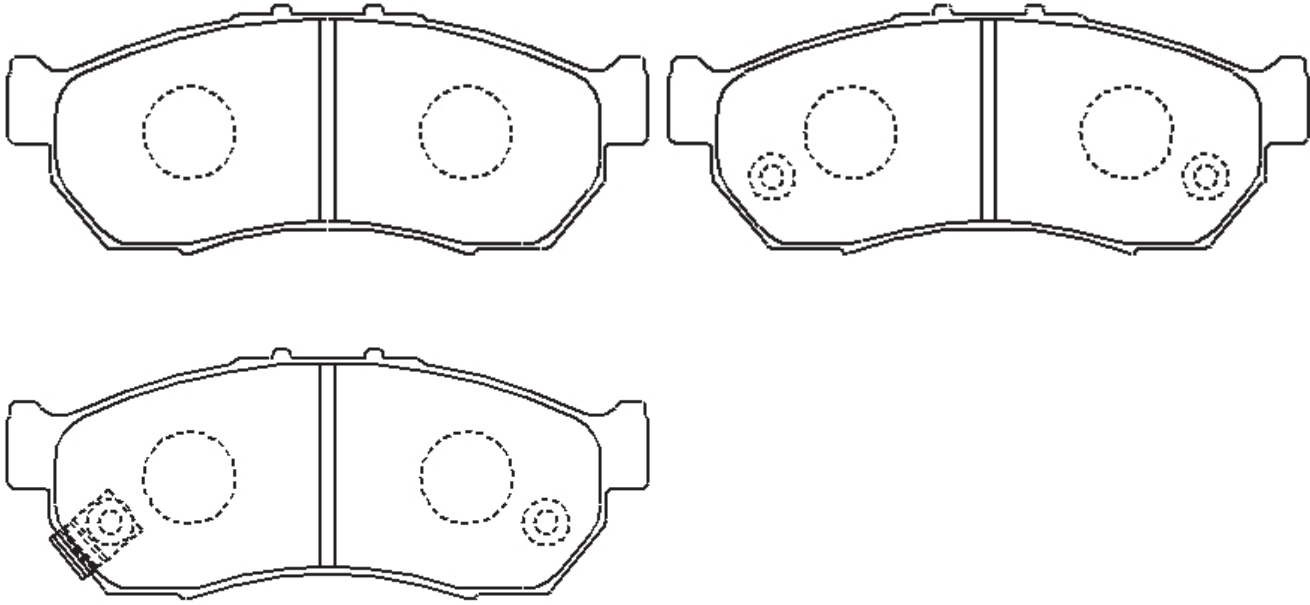

HN-526						132.0	59.5	17.8	AN-719WK
									D3125M-02

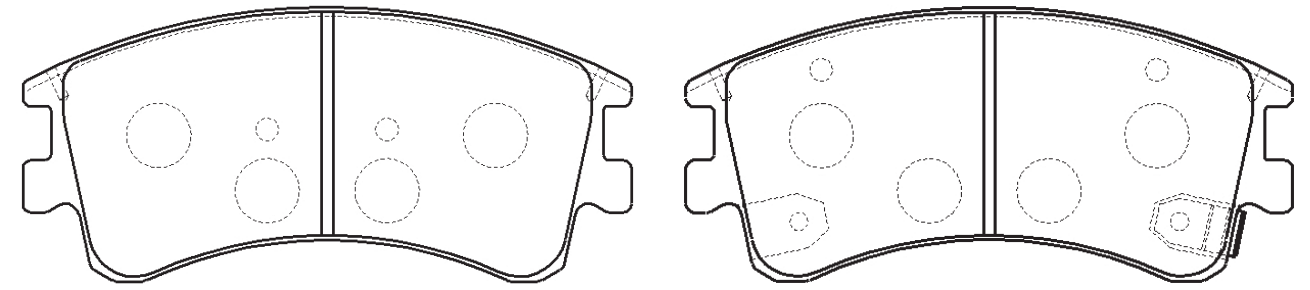

HN-527	147.7	61.0	17.5	AN-735WK					
				D2265-02					

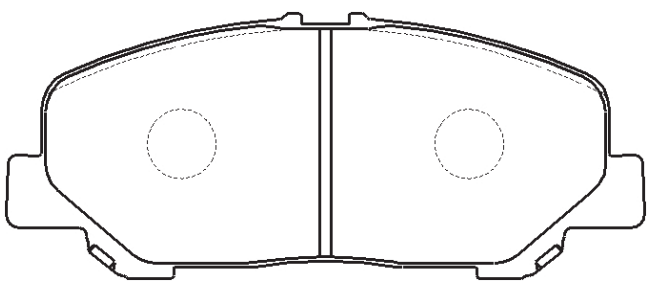

HN-528						101.8	46.0	15.0	AN-709WK
									D2239M-02

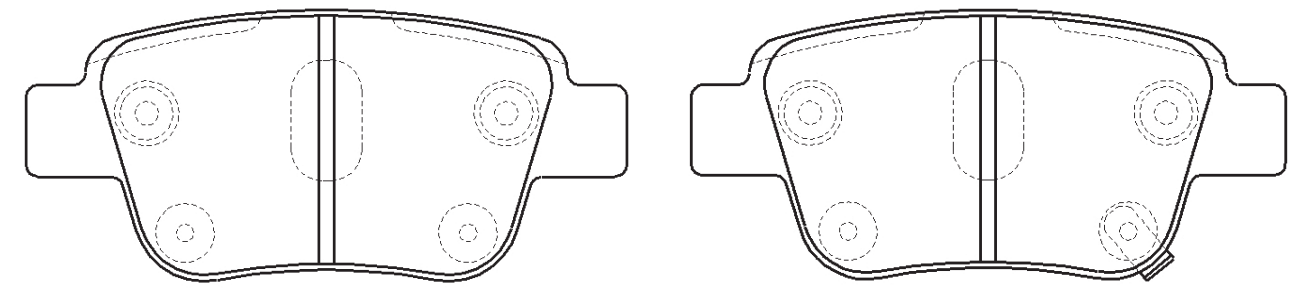

HN-No.	W	H	T	AKNo.	HN-No.	W	H	T	AKNo.
				MKNo.					MKNo.

HN-529						108.5	45.5	14.7	AN-706WK
									D9039M-02

※1pad w/sensor, 3pads w/o sensor

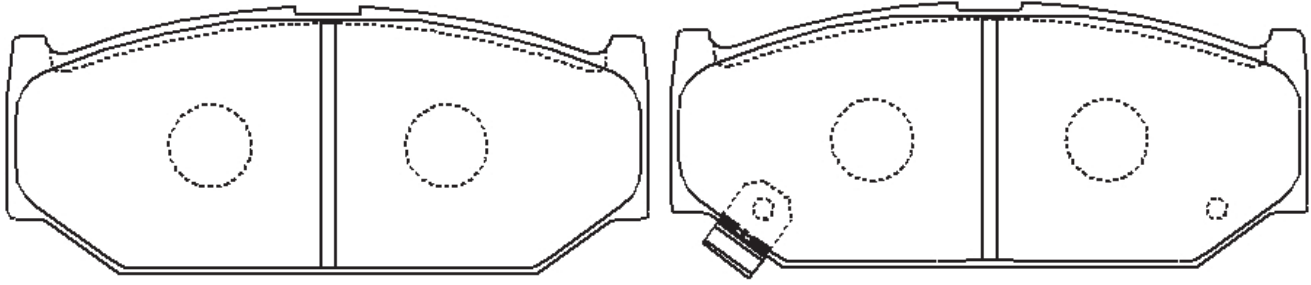

HN-530	146.5	57.0	17.5	AN-732K	HN-531	158.8	56.0	16.5	AN-629WK
				D2268-02					D1211M-02

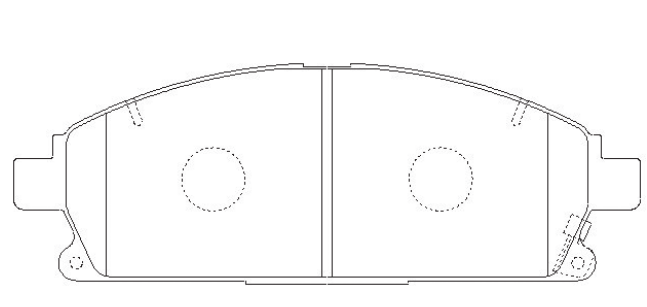
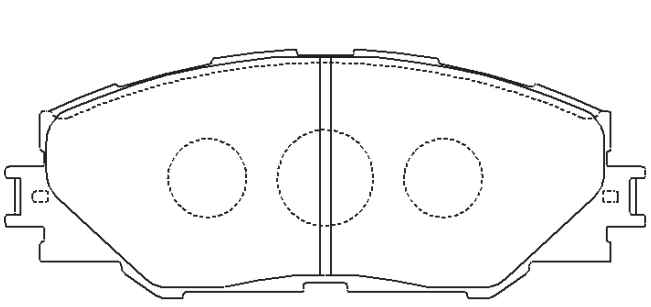

HN-540						116.5	50.3	16.5	AN-713WK
									D2257M-02

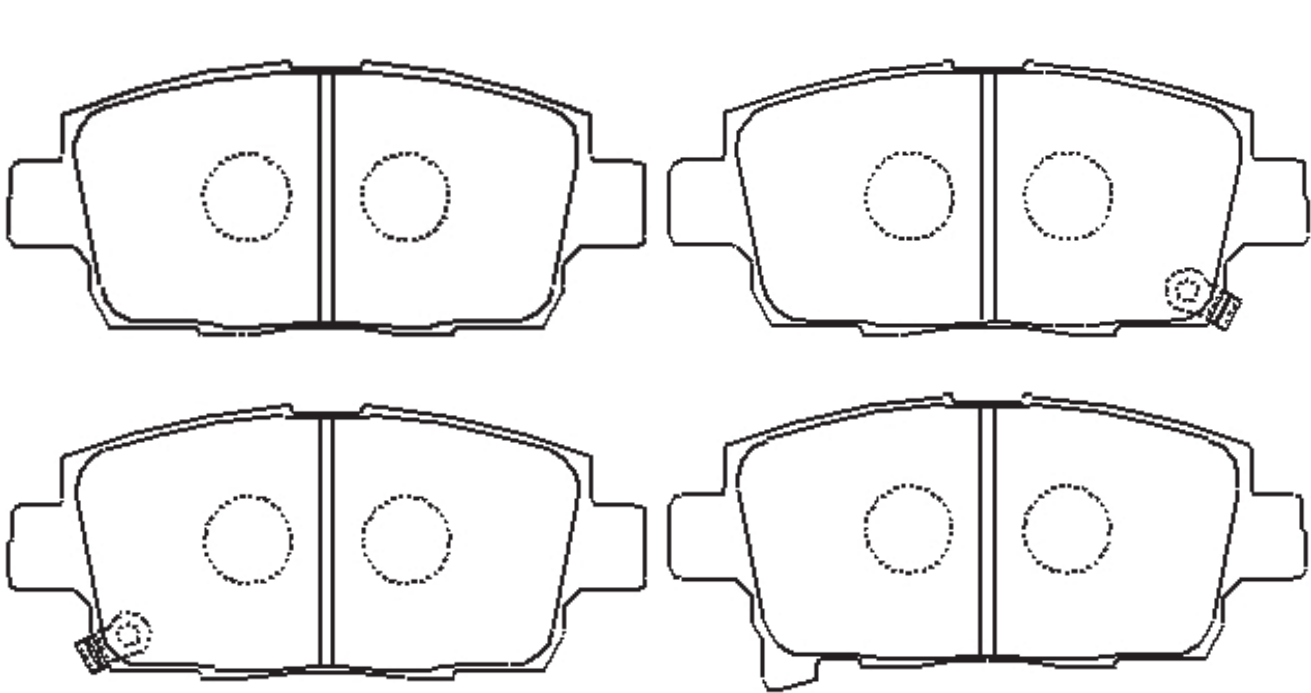

HN-541						143.7	83.2	17.7	AN-755WK
									D2278M-02

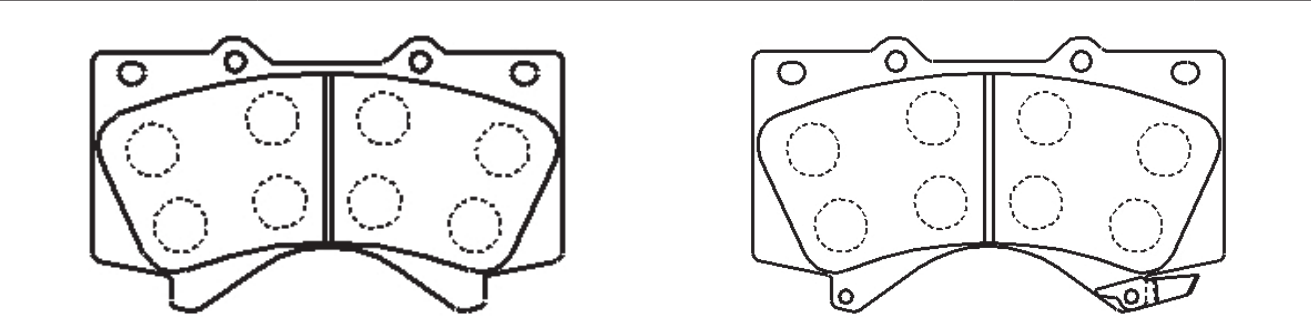

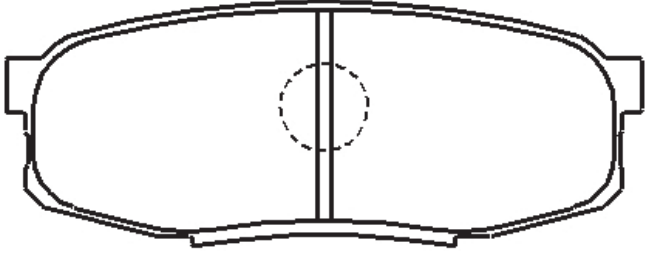
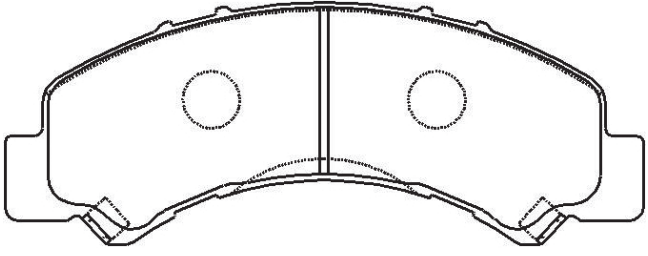
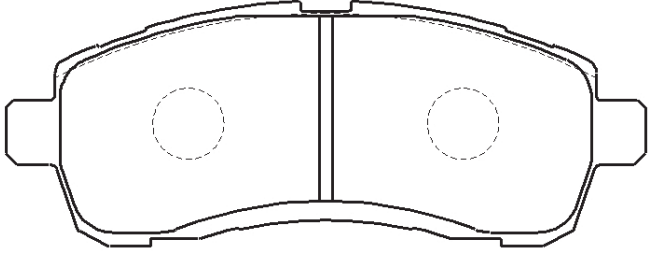
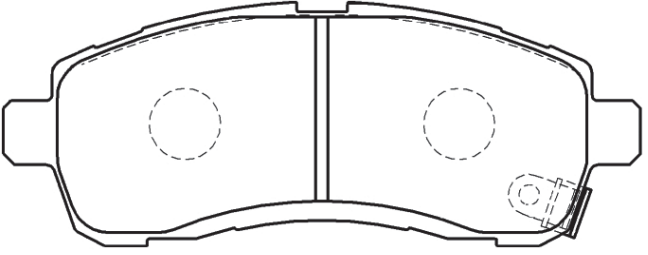
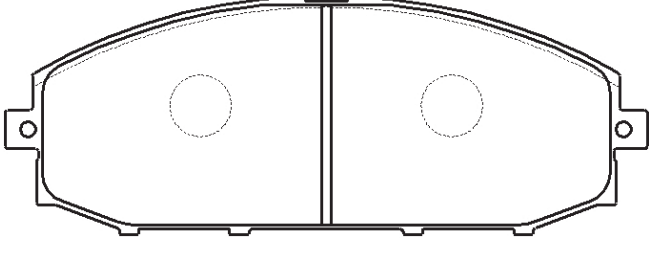
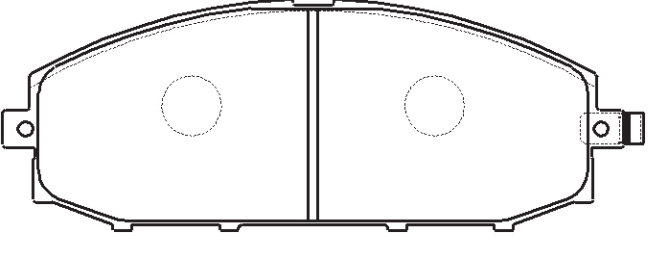
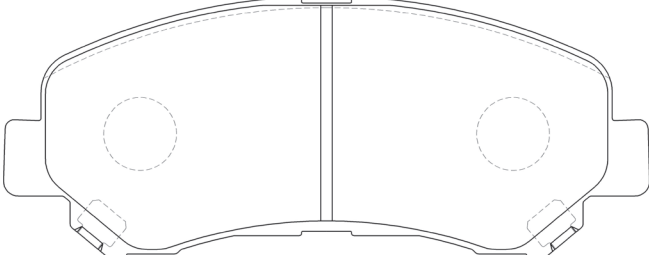
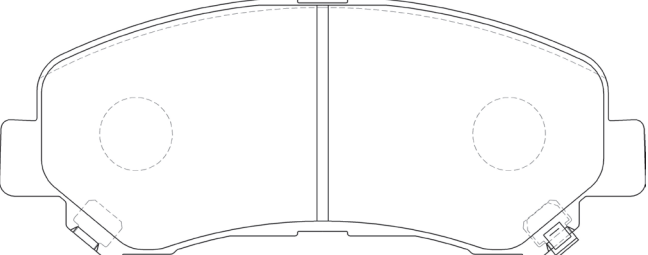
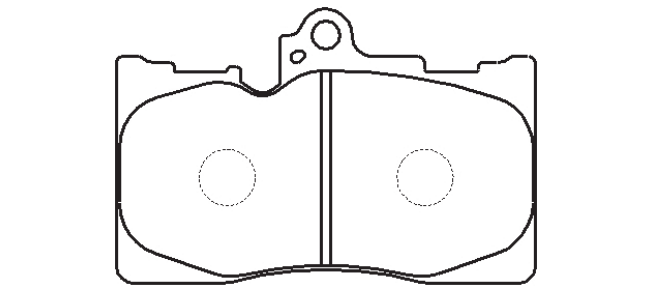
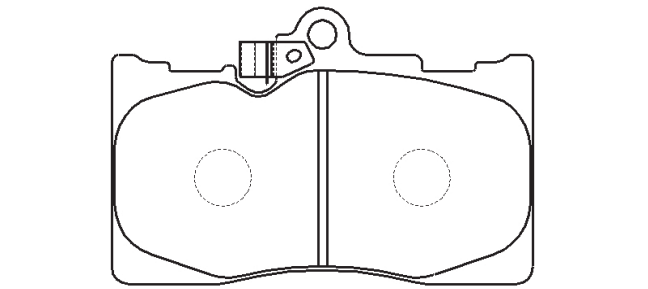
HN-No.	W	H	T	AKNo.	HN-No.	W	H	T	AKNo.
				MKNo.					MKNo.
HN-542	116.0	45.0	16.9	AN-756K	HN-543	178.4	67.4	20.8	AN-721WK
				D2281-02					D4054-02
									
HN-544									AN-753WK
					125.6	48.0	14.8		D3144M-02
※1pad w/sensor, 3pads w/o sensor									
									
HN-545									AN-752WK
					165.8	61.5	17.7		D1275M-02
									
HN-546									AN-751WK
					142.0	59.0	16.8		D1276-02
※1pad w/sensor, 3pads w/o sensor									
									
HN-547									AN-731WK
					118.6	77.5	17.3		D2266M-02
									

HN-No.	W	H	T	AKNo.	HN-No.	W	H	T	AKNo.
				MKNo.					MKNo.
HN-548						144.9	55.0	15.7	AN-650WK
									D6108-02

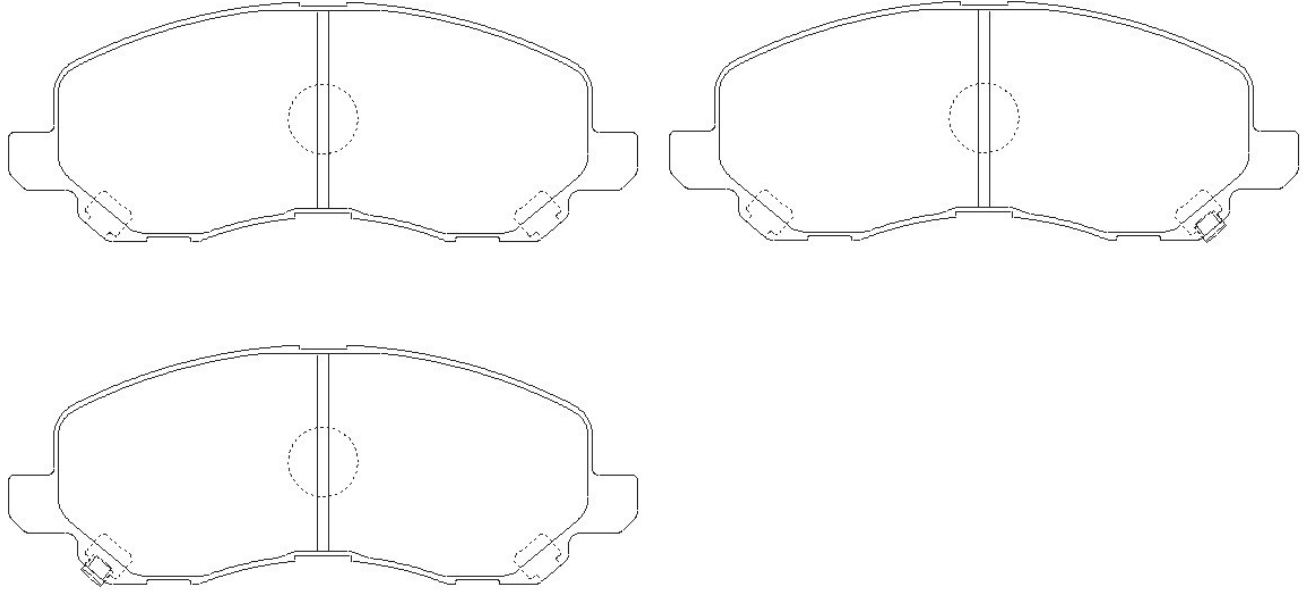

HN-550						117.6	58.5	17.3	AN-636K
									D2242-02

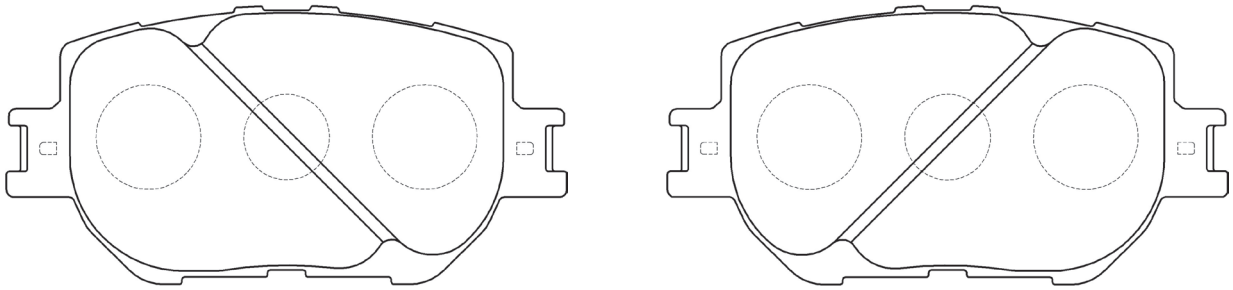

HN-552	144.2	46.7	15.5	AN-758WK	HN-553	170.1	57.4	18.0	AN-748K
				D2282-02					D2276-02

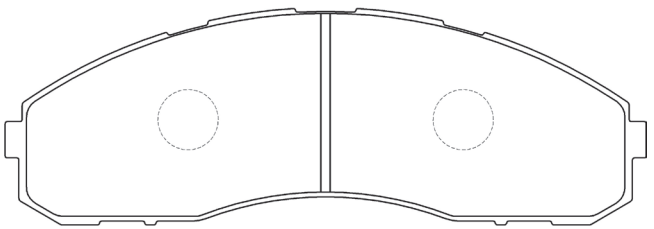
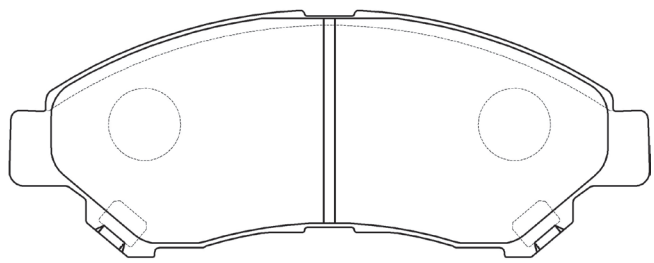

HN-No.	W	H	T	AKNo.	HN-No.	W	H	T	AKNo.
				MKNo.					MKNo.
HN-554						135.8	62.5	15.0	AN-711WK
									D1264M-02

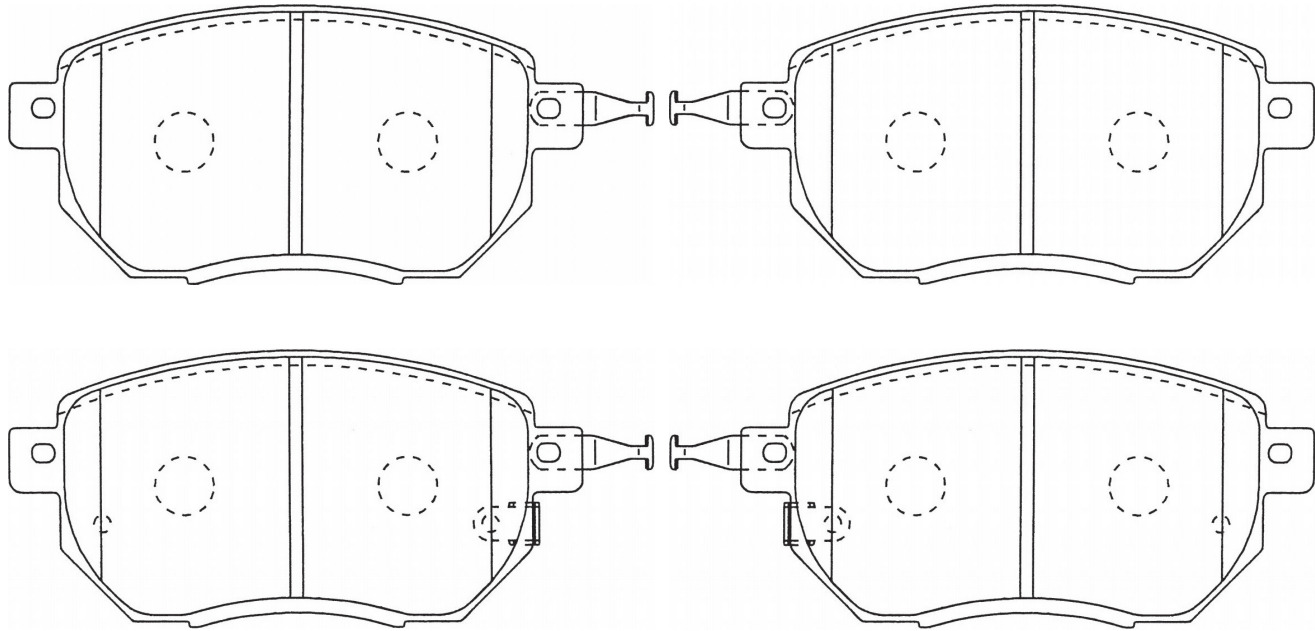

HN-555						138.7	43.0	13.5	AN-761WK
									D1288M-02

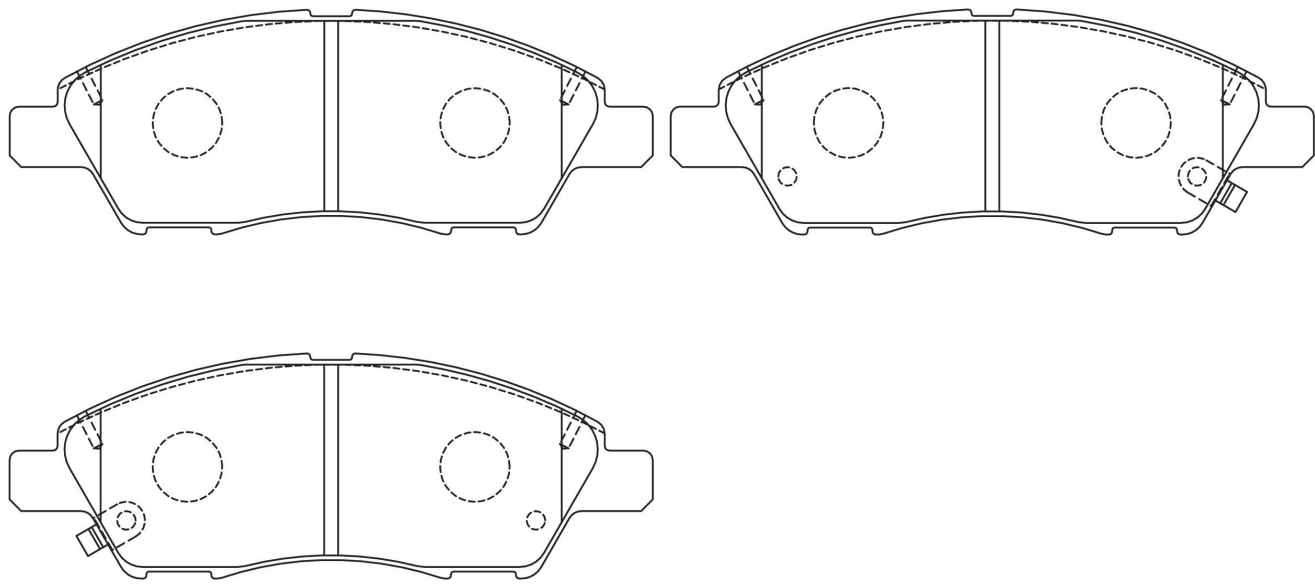

HN-556						155.4	51.0	16.6	AN-767WK
									D1294M-02

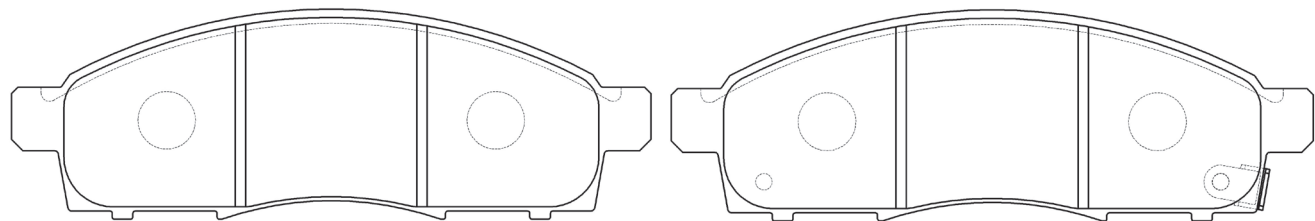

HN-No.	W	H	T	AKNo.	HN-No.	W	H	T	AKNo.
				MKNo.					MKNo.
HN-557						99.8	43.7	13.5	AN-750WK
									D1284M-02

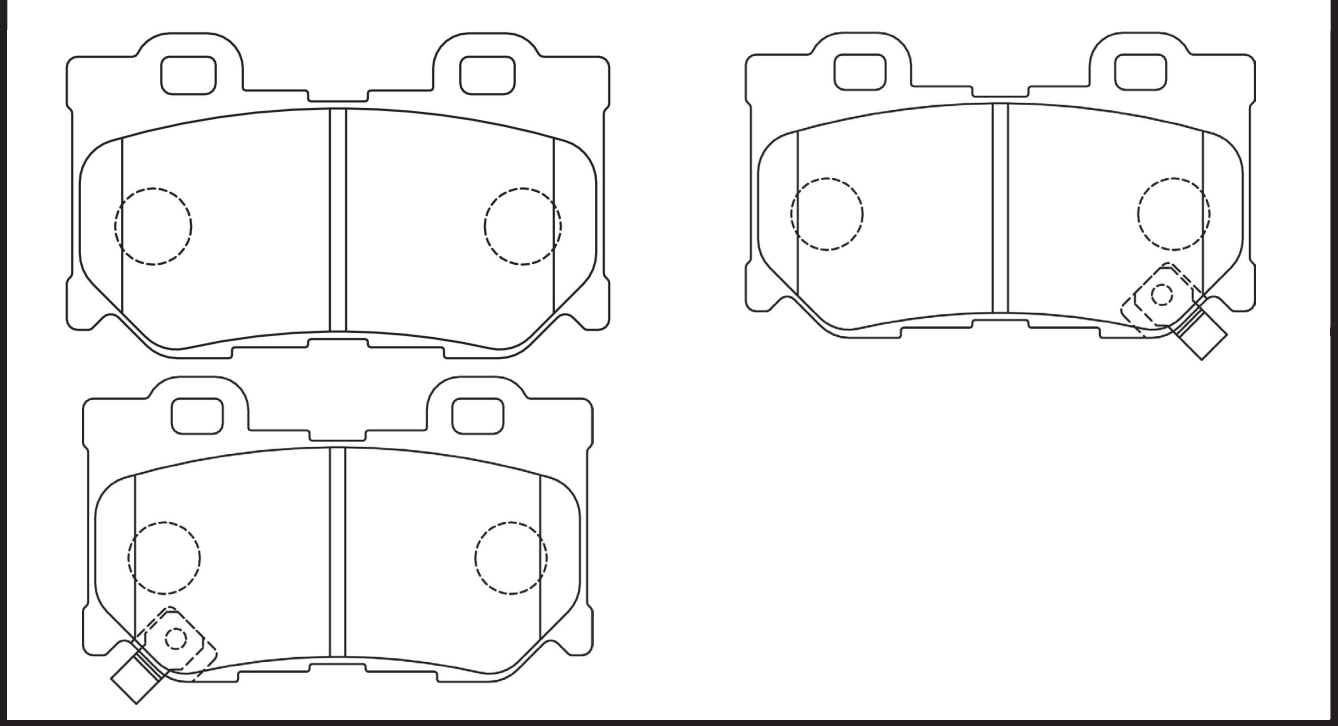

HN-558						103.7	44.7	14.0	AN-697WK
									D5134M-02

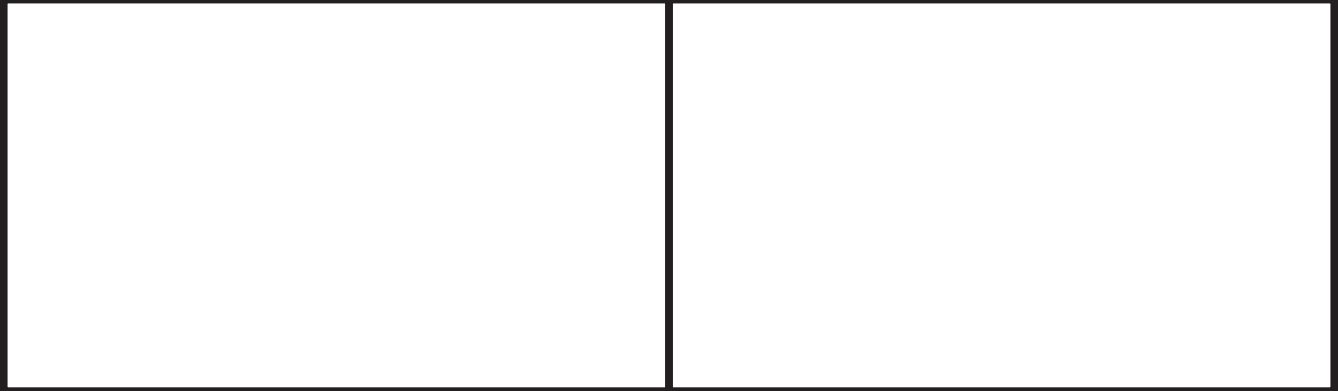
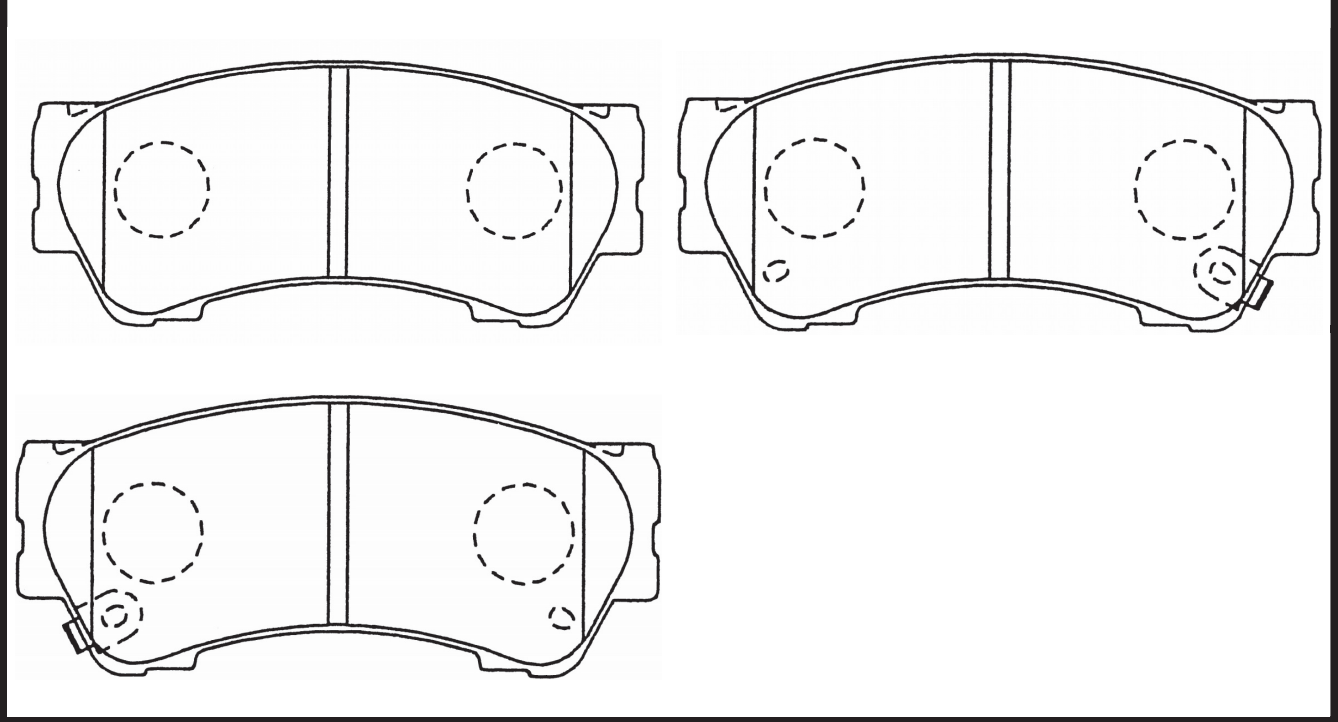

HN-No.	W	H	T	AKNo.	HN-No.	W	H	T	AKNo.
				MKNo.					MKNo.
HN-559						154.8	58.6	18.0	AN-743WK
									D5153M-02

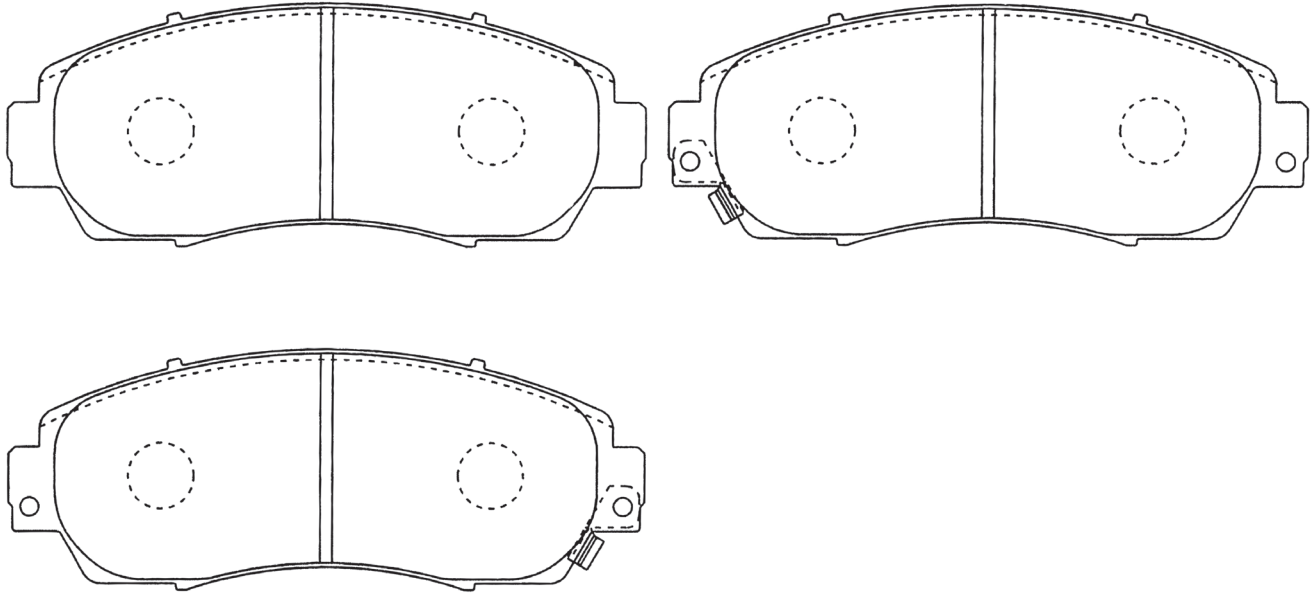

HN-560						136.5	55.8	16.0	AN-763WK
									D5168M-02

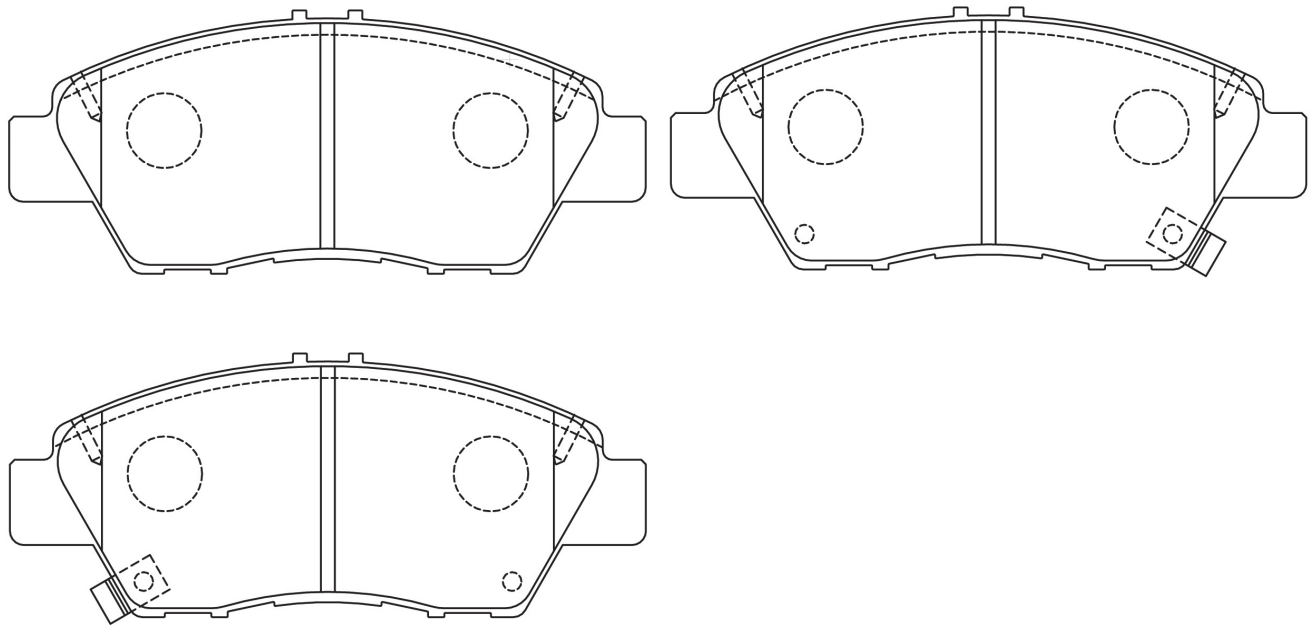

HN-561	139.2	58.0	17.5	AN-736K					
				D3142-02					

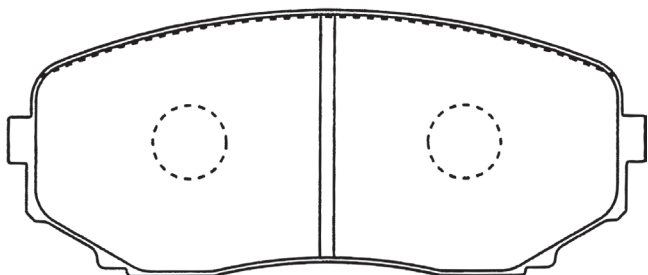

HN-No.	W	H	T	AKNo.	HN-No.	W	H	T	AKNo.
				MKNo.					MKNo.
HN-562						125.5	45.5	15.5	AN-754WK
									D0051M-02

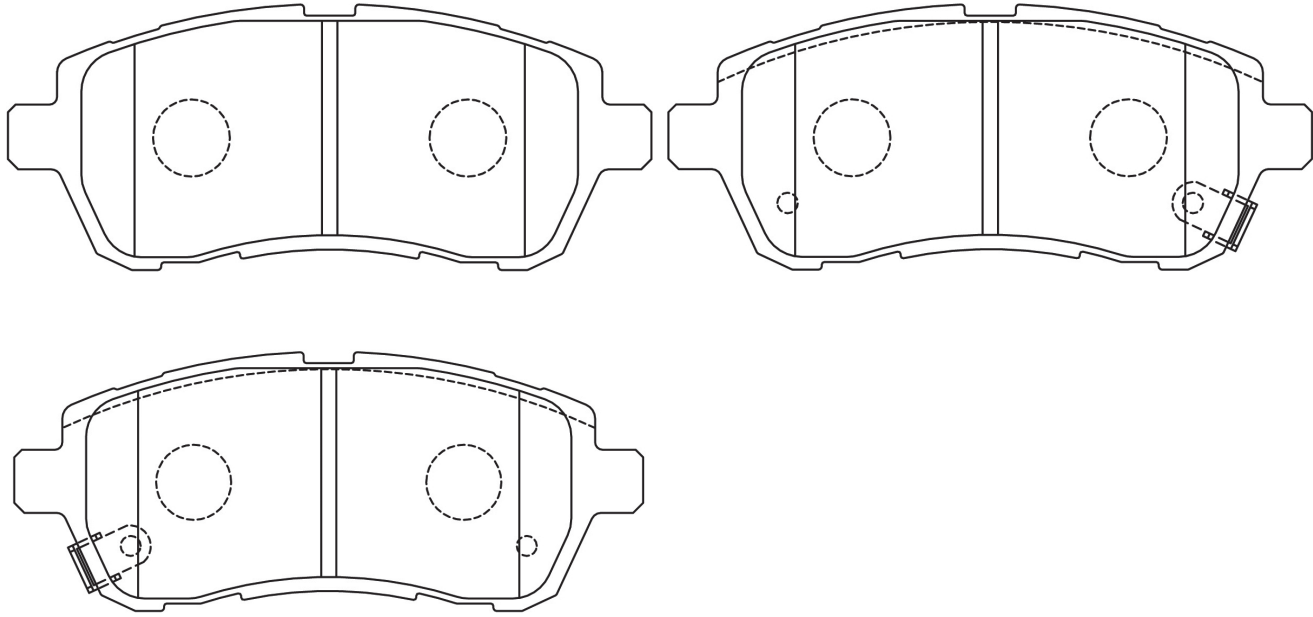

HN-563						136.8	48.6	17.0	AN-759WK
									D3146M-02

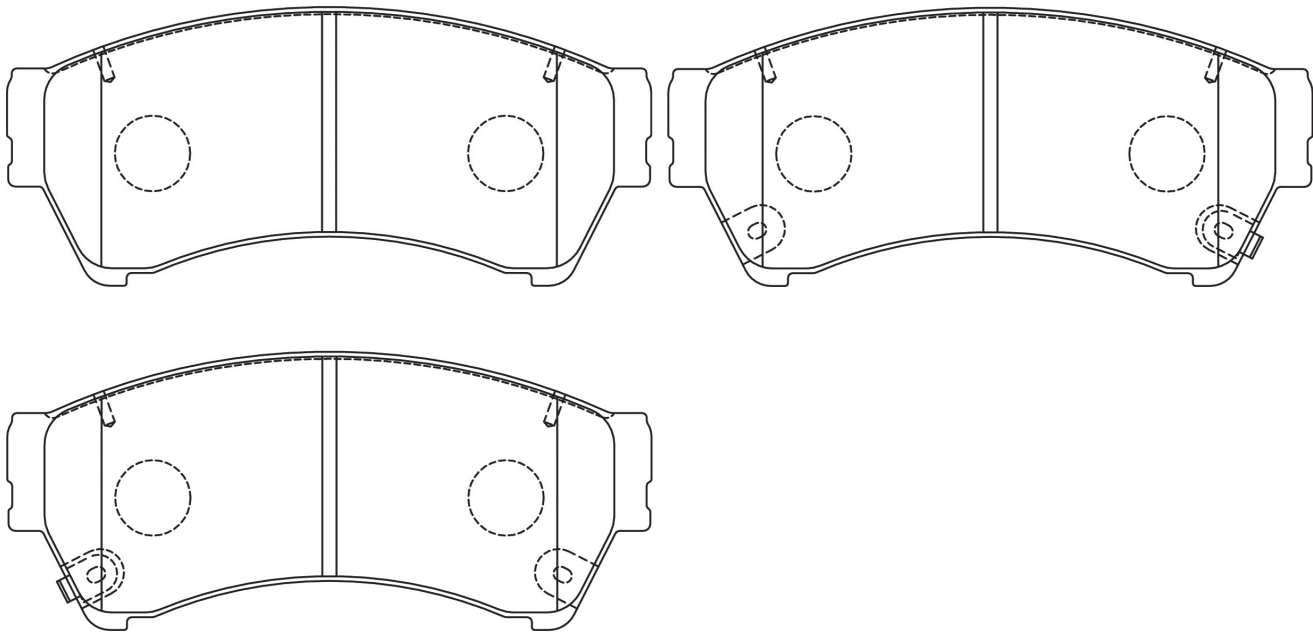

HN-564	110.7	42.2	16.5	AN-737K					
				D3143-02					

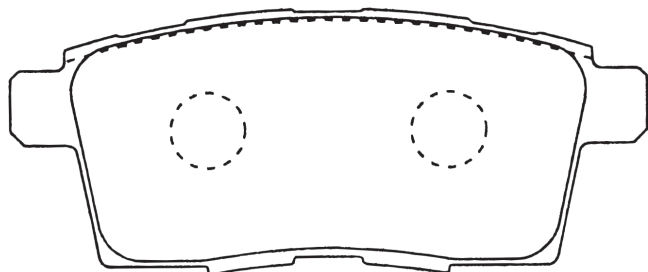

HN-No.	W	H	T	AKNo.	HN-No.	W	H	T	AKNo.
				MKNo.					MKNo.

HN-565	105.4	38	13.7	AN-768WK
				D1286M

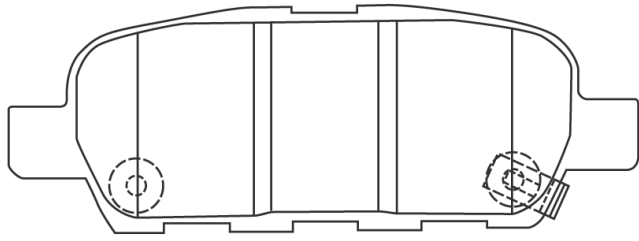

HN-566		108.5	41.9	14.6	AN-769WK
					D9061M

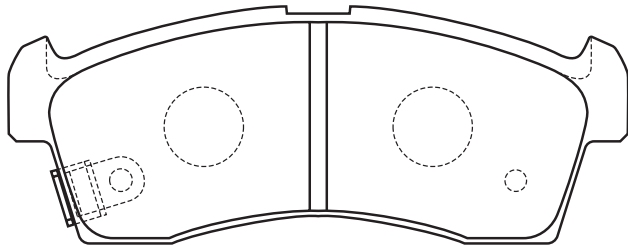
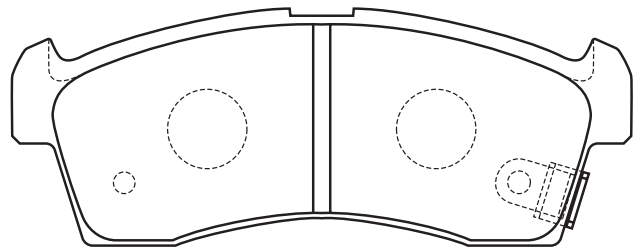
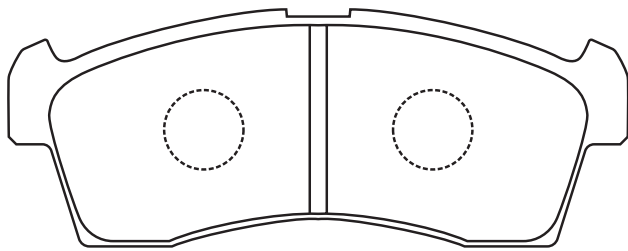

HN-567	122.6	49.6	17.5	AN-764K
				D2315

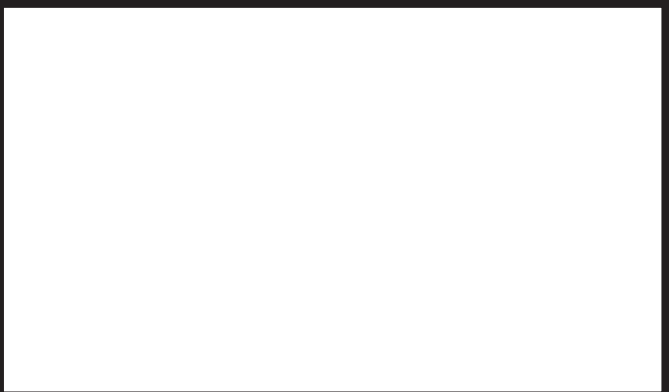
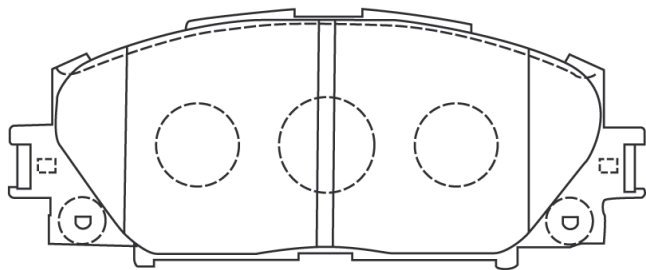

HN-568		98.5	42.3	14.9	AN-716WK
		98.5	42.3	14.9	D2323M

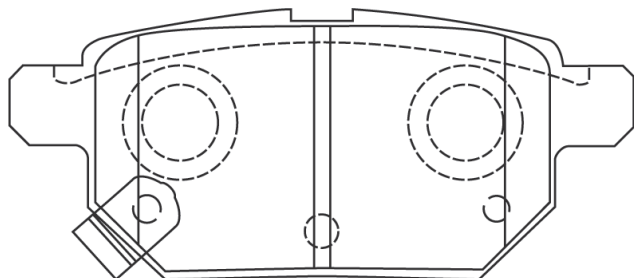
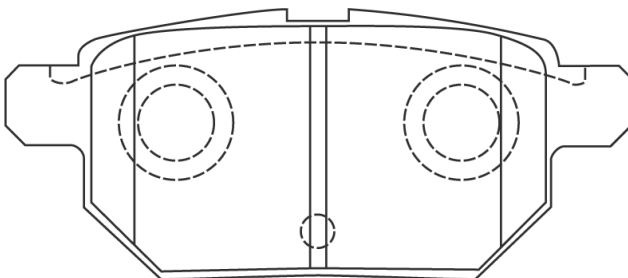

HN-No.	W	H	T	AKNo.	HN-No.	W	H	T	AKNo.
				MKNo.					MKNo.
HN-569	11.5	45.6	14.8	AN-765K	HN-570				AN-788WK
				D2326					D6152M

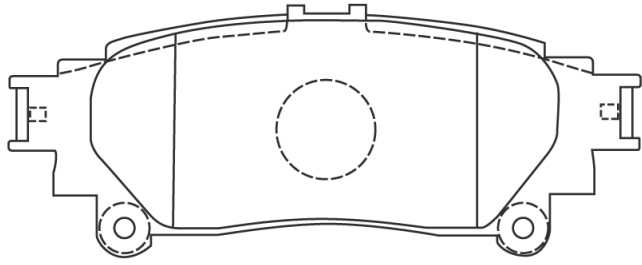

HN-571					139.4	58.6	19	AN-774WK
								D6139M

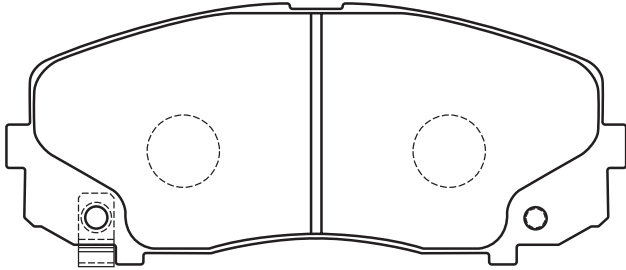
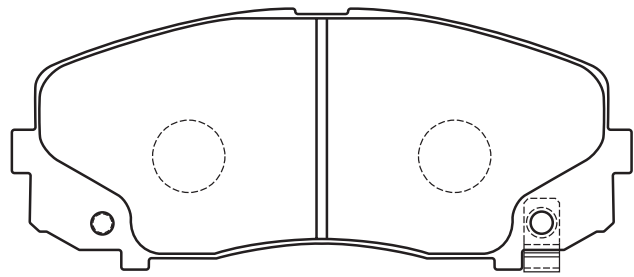
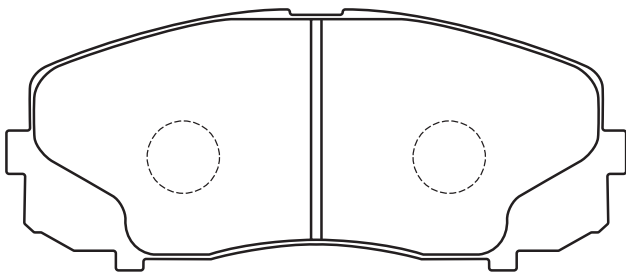

HN-572					123.2	26.5	16.5	AN-775WK
								D6137M

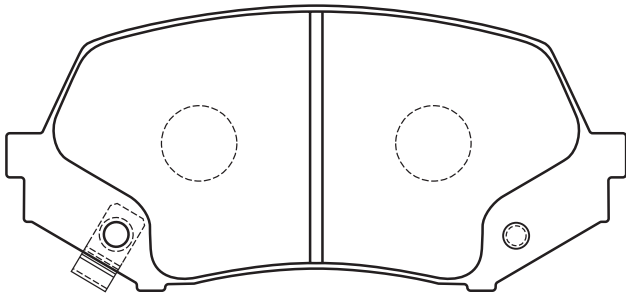
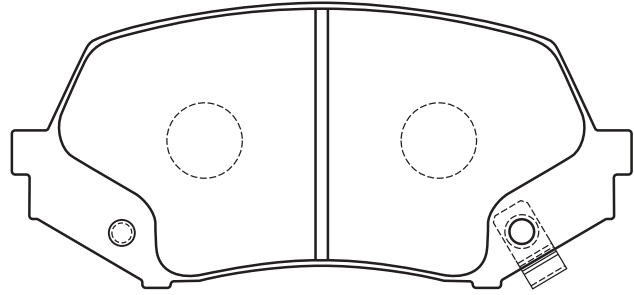
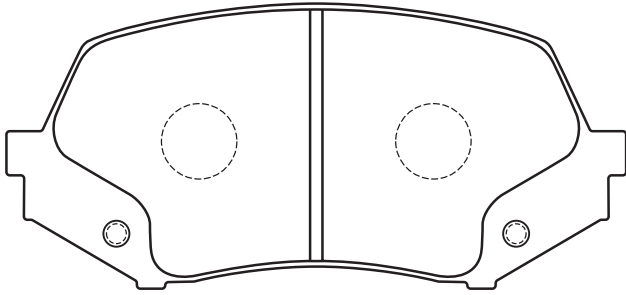

HN-No.	W	H	T	AKNo.	HN-No.	W	H	T	AKNo.
				MKNo.					MKNo.
HN-573						163.8	62.2	19	AN-781WK
									D6149M

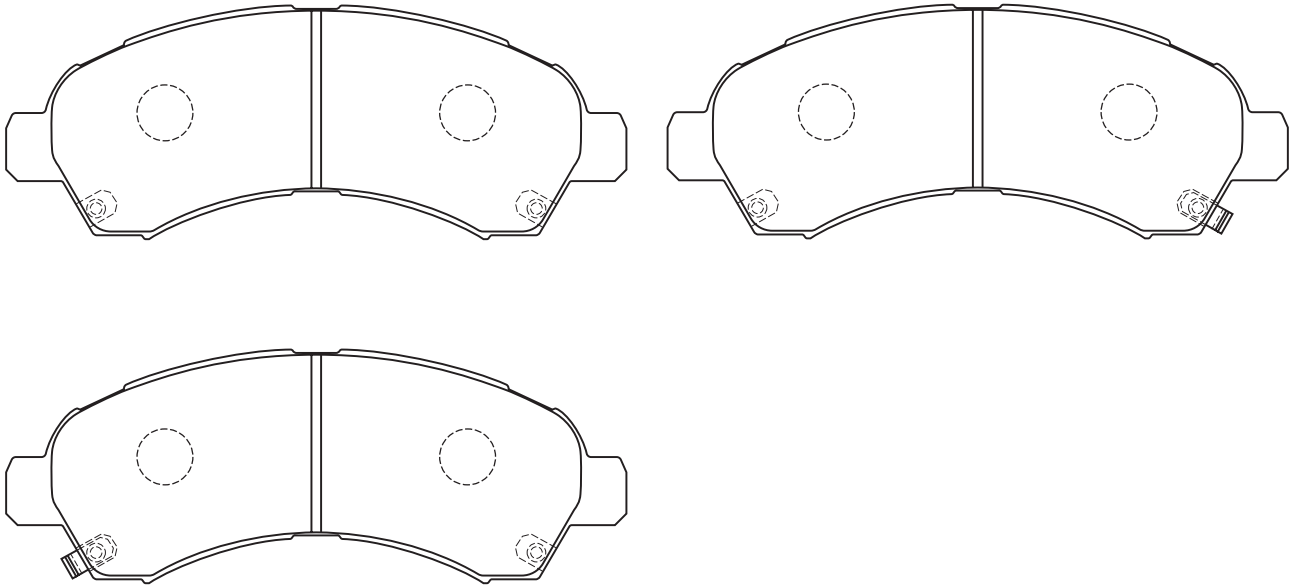

HN-574						184.2	70.7	19.5	AN-780WK
									D6144M

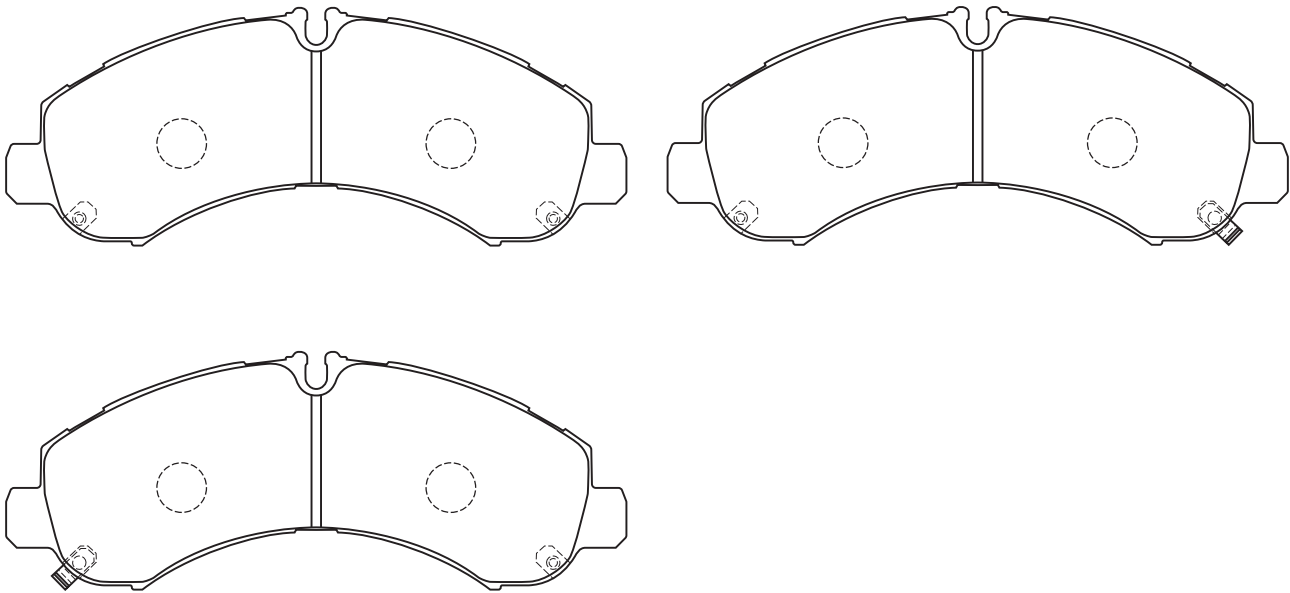

HN-No.	W	H	T	AKNo.	HN-No.	W	H	T	AKNo.
				MKNo.					MKNo.

HN-575				144.3	61.4	19.5	AN-782WK
				144.3	61.4	19.5	D6133M

8PCS

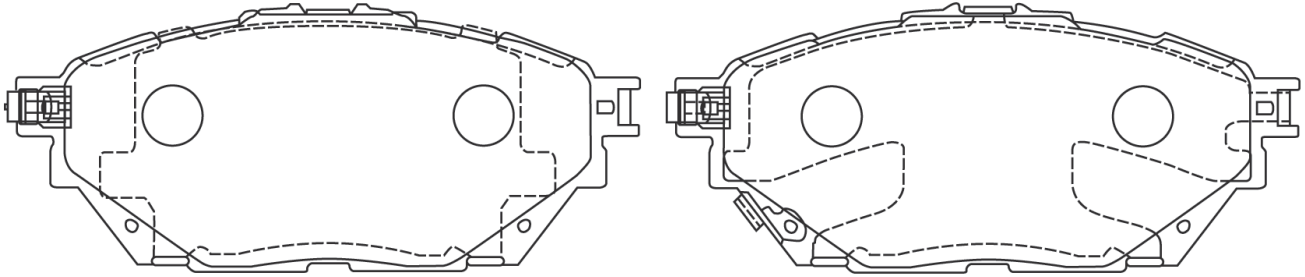

HN-576				146.6	55.9	17.6	AN-770WK
				146.6	55.9	17.6	D6131

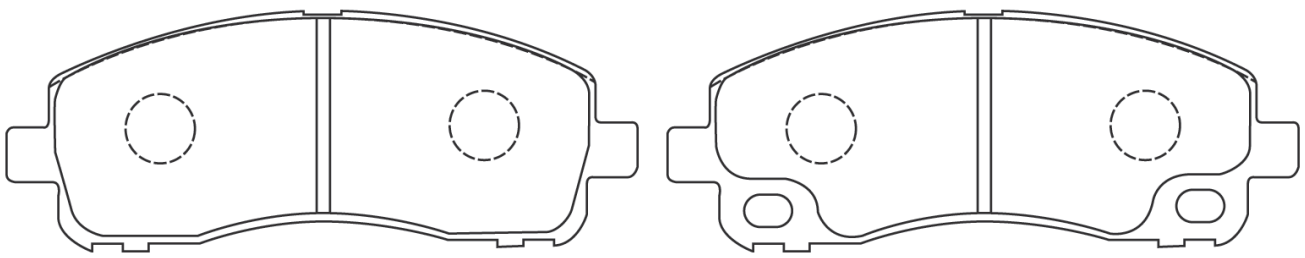

HN-578				123.2	51.9	15	AN-718K
				123.2	51.9	15	D3132

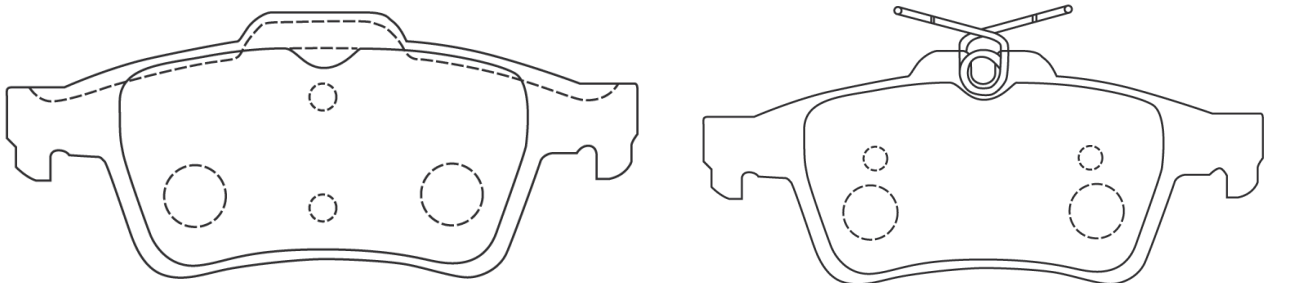

HN-579				144.2	61.3	19.5	AN-782WK
							D6133M

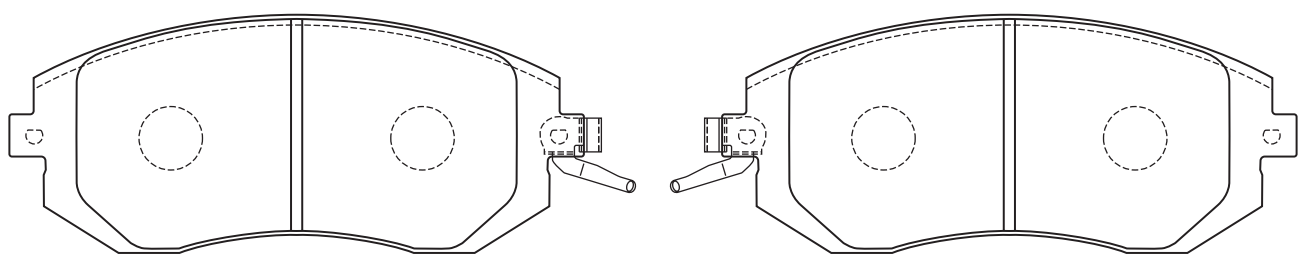

HN-No.	W	H	T	AKNo.	HN-No.	W	H	T	AKNo.
				MKNo.					MKNo.

HN-580						89	47.6	14	AN-684WK
						89	47.6	14	

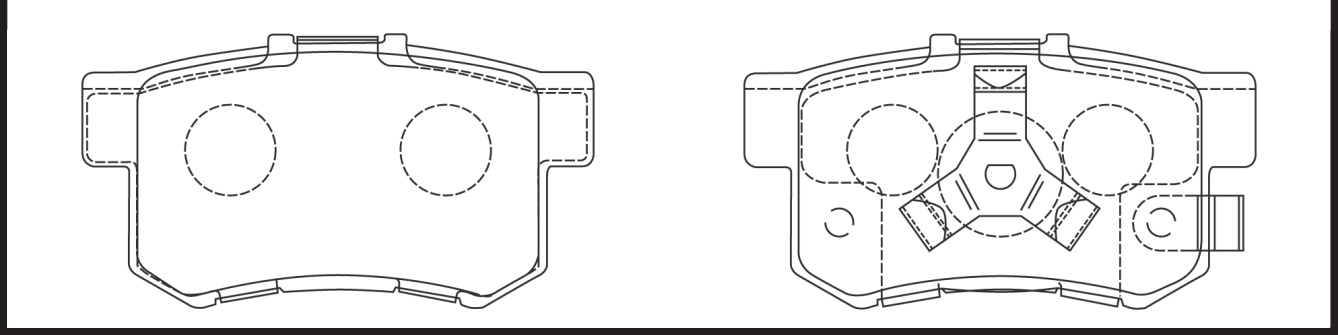

HN-581						98.7	40.2	14.4	AN-773WK
						98.7	40.2	14.4	D9066M

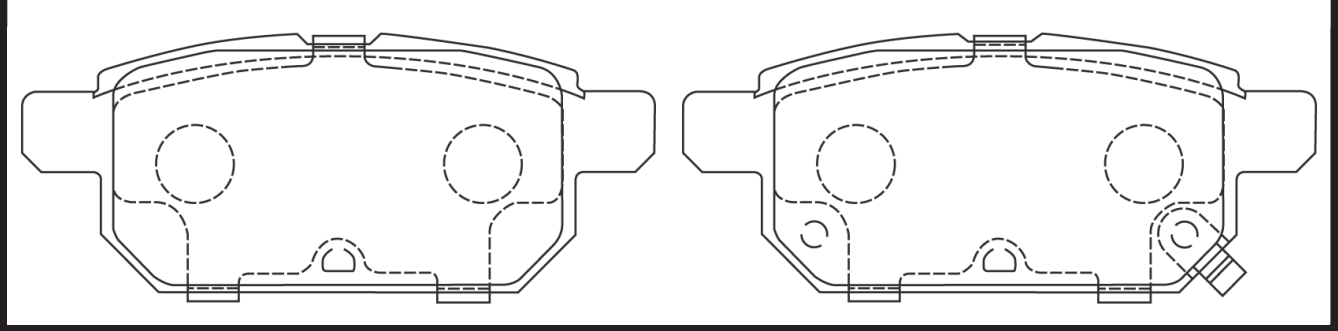

HN-582						108.5	41.9	14.6	
									D9074M

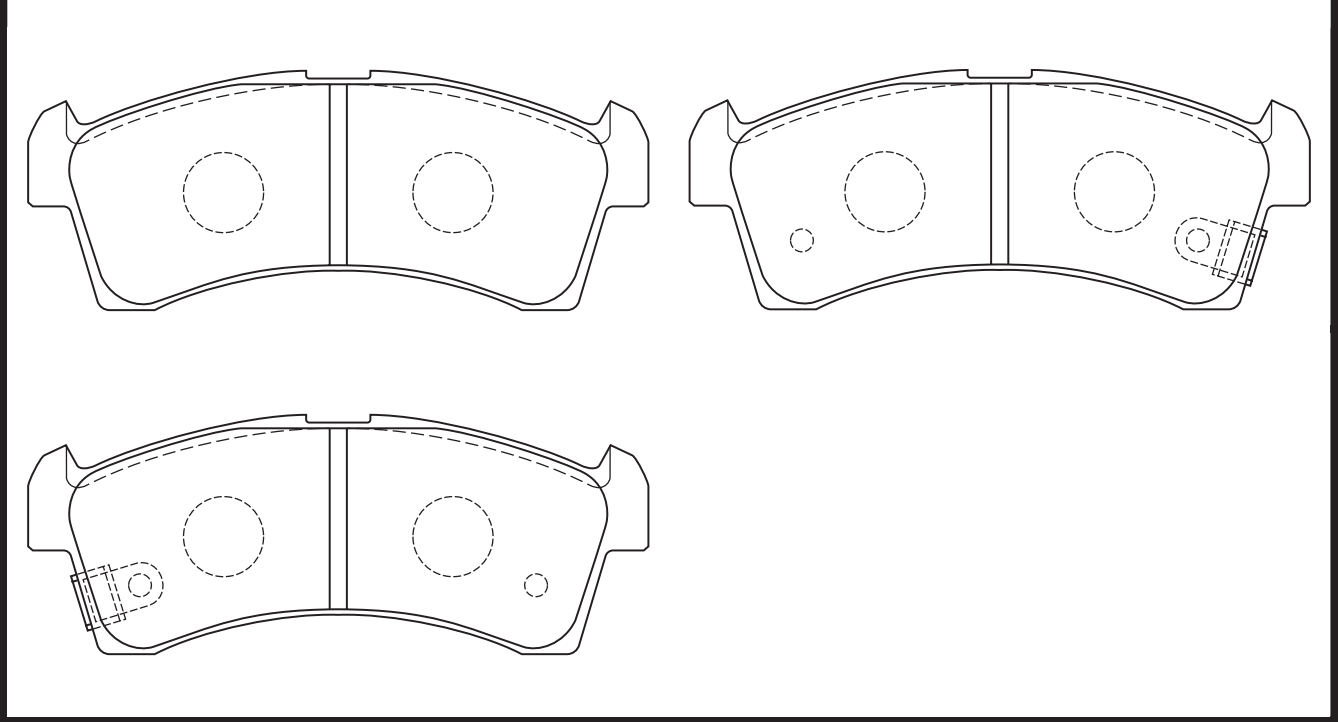

HN-No.	W	H	T	AKNo.	HN-No.	W	H	T	AKNo.
				MKNo.					MKNo.

HN-600					142	61.4	16	AN-783WK
								D3155

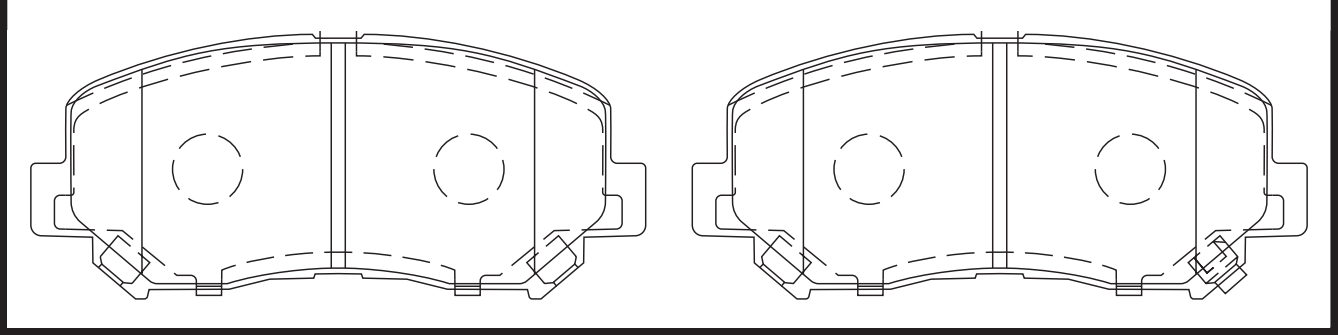

HN-601	104.6	43.1	14	AN-784WK				
				D3156				

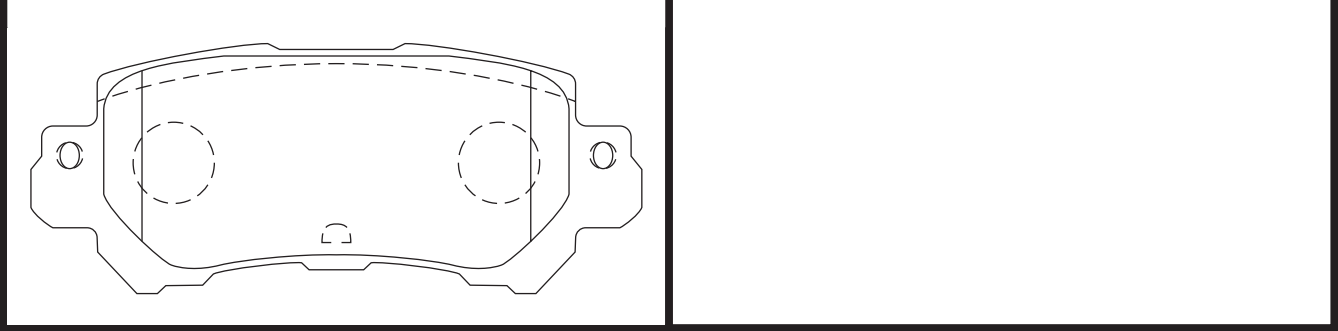

HN-603					101.4	44.4	14	AN-786K
								D6146M

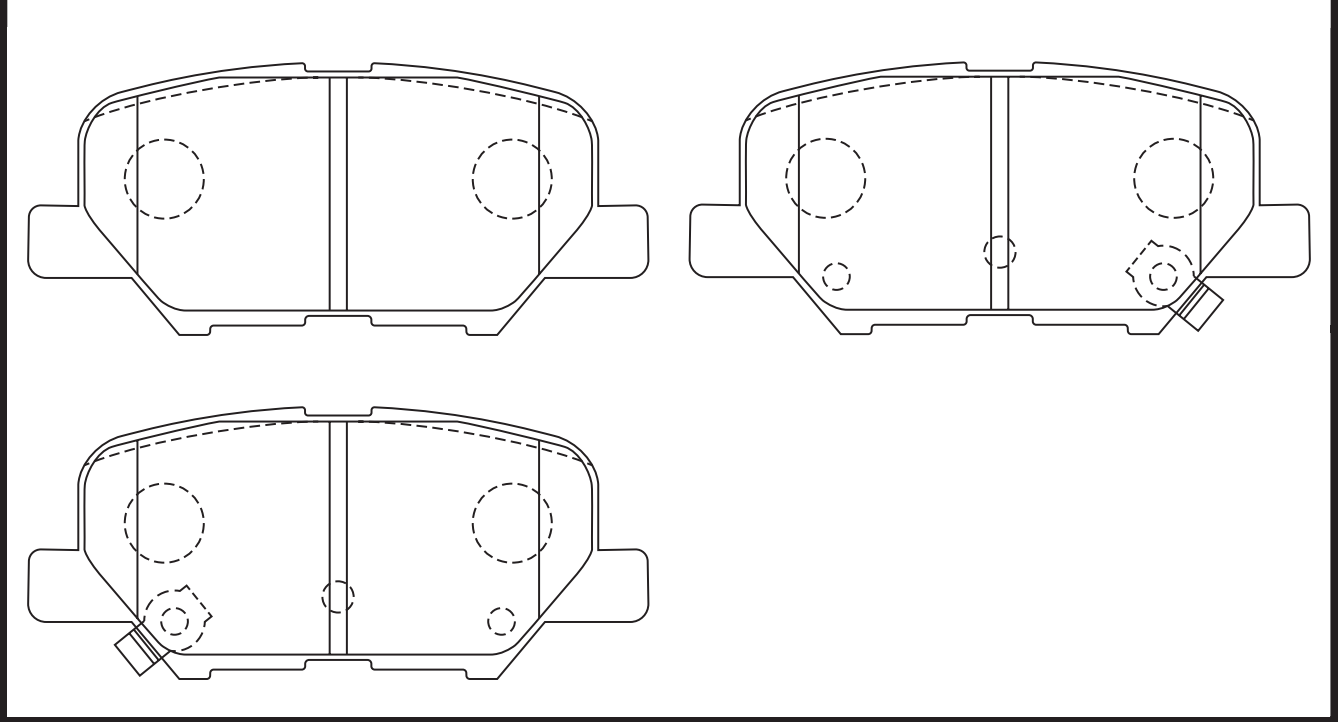

HN-No.	W	H	T	AKNo.	HN-No.	W	H	T	AKNo.
				MKNo.					MKNo.
HN-604						93.5	46.6	14.5	AN-777WK
									D5162M

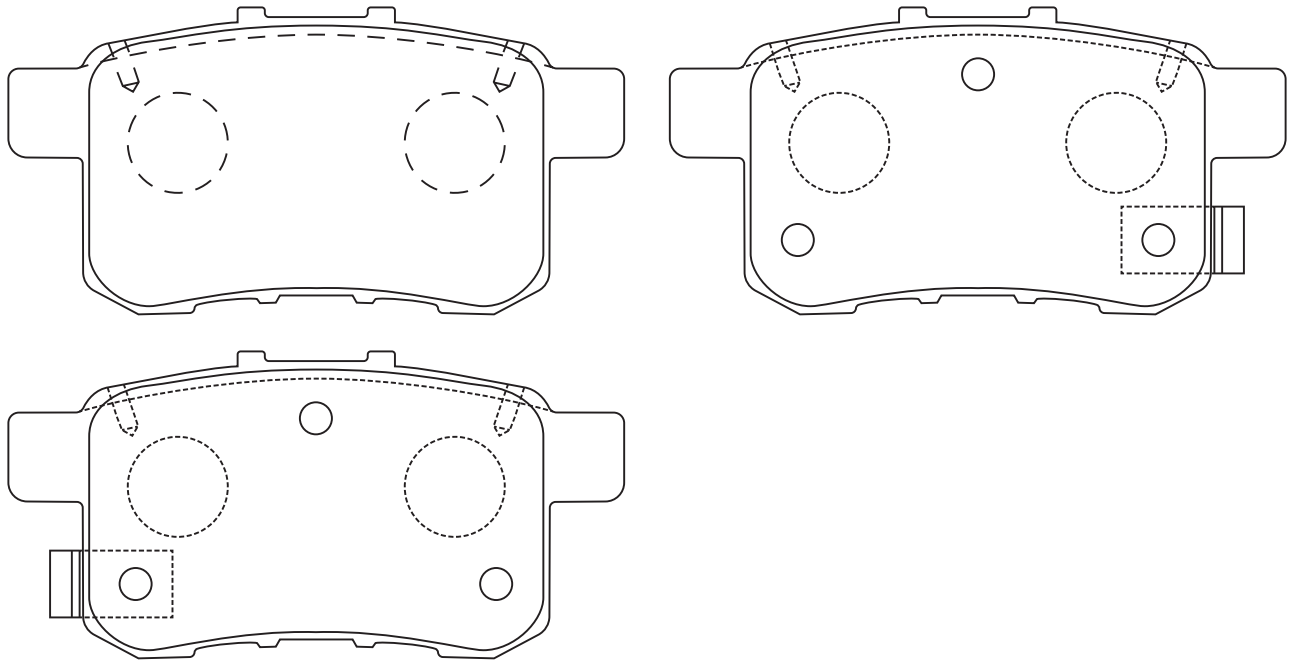

HN-609				148.8		60.9	16		AN-789WK
									D5214M

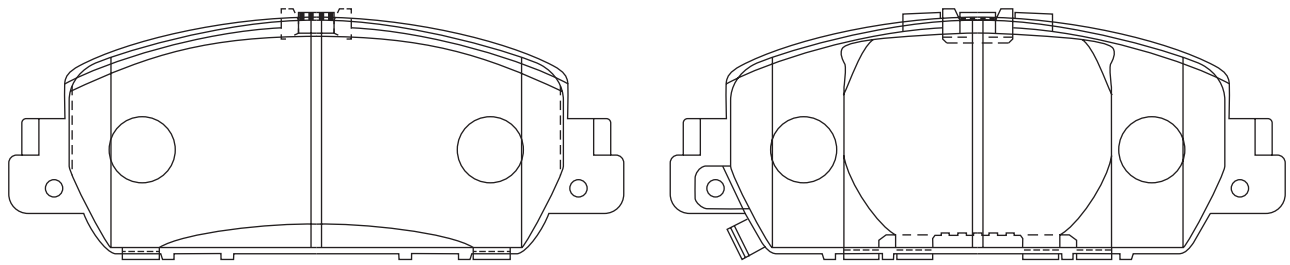

HN-610				158.8		55	15		AN-772WK
									D1300M

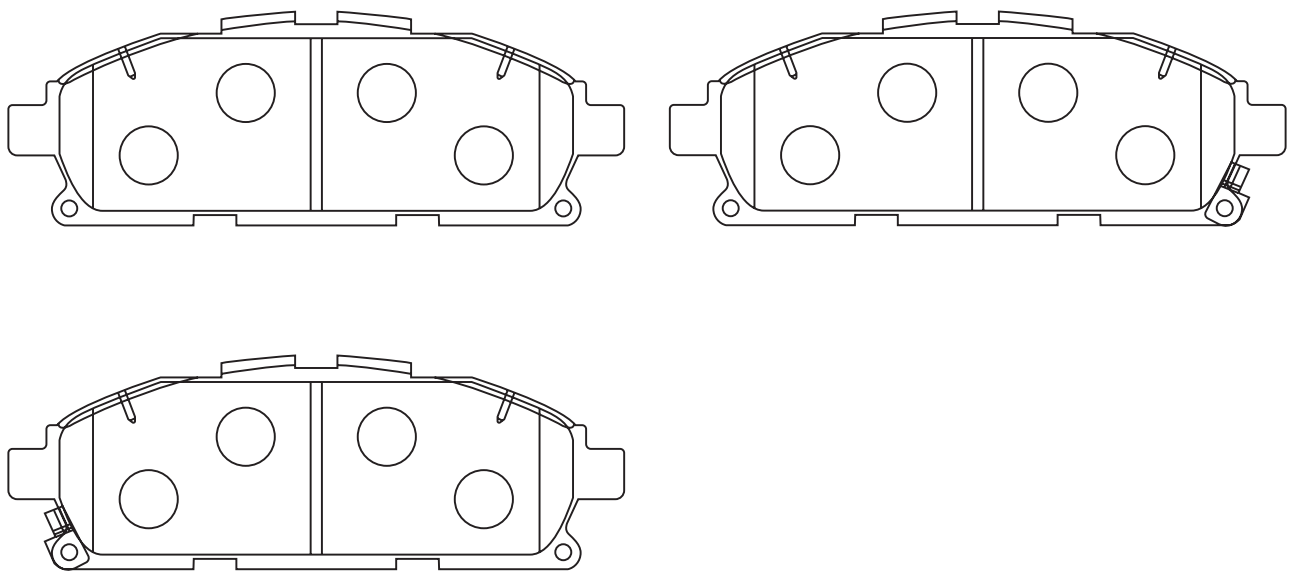

HN-No.	W	H	T	AKNo.	HN-No.	W	H	T	AKNo.
				MKNo.					MKNo.
HN-611						110.6	39.7	16	AN-766WK
									D7070M

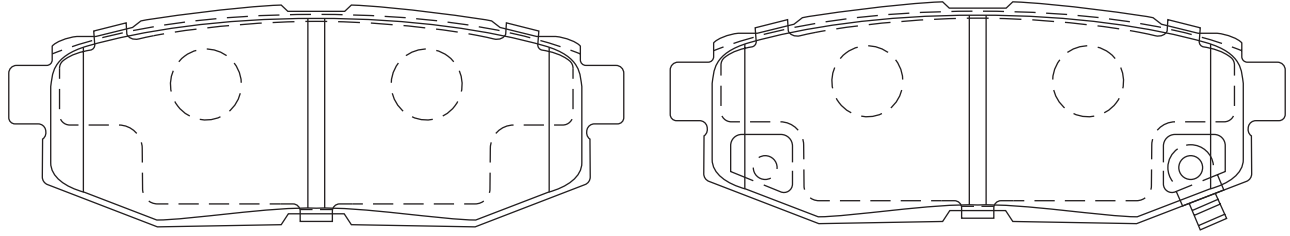

HN-615						142	55.4	15.5	AN-791WK
									D3163M

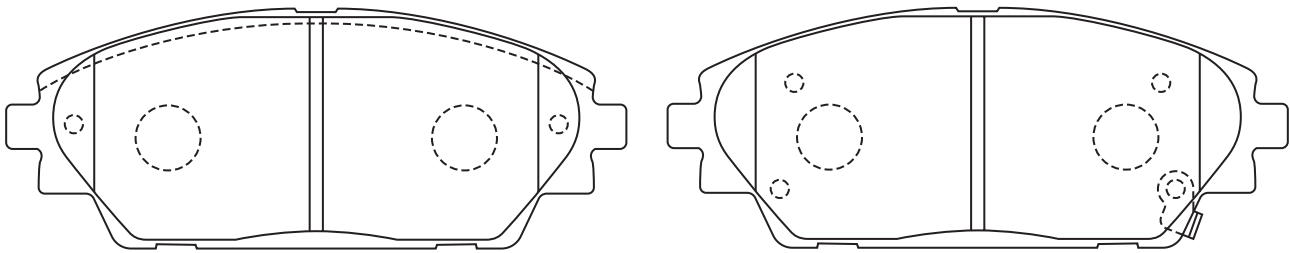

HN-616						101.5	44.6	13.5	AN-792WK
									D3166M

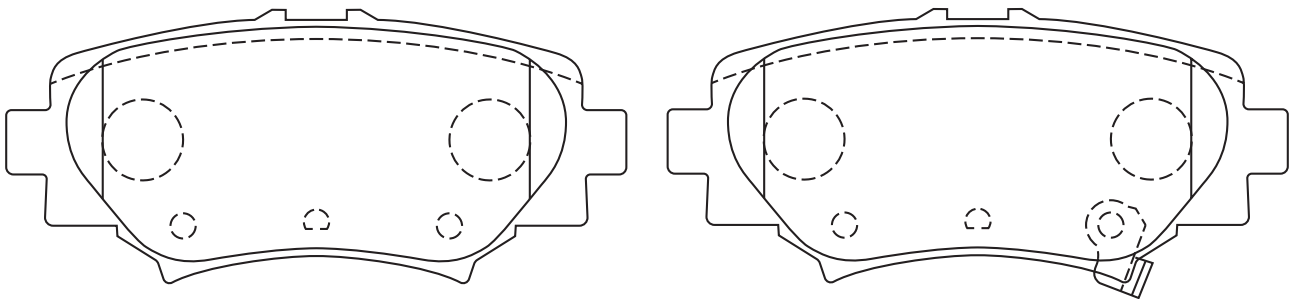

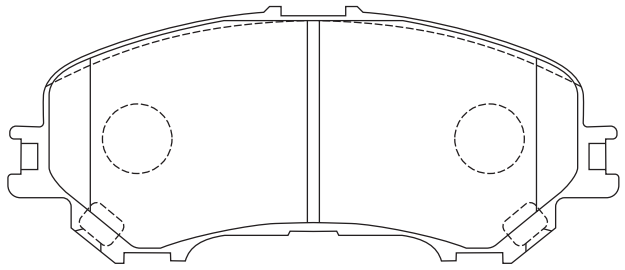
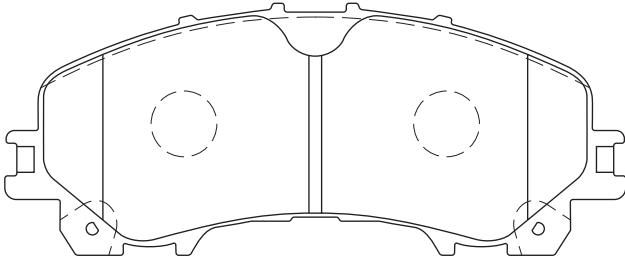
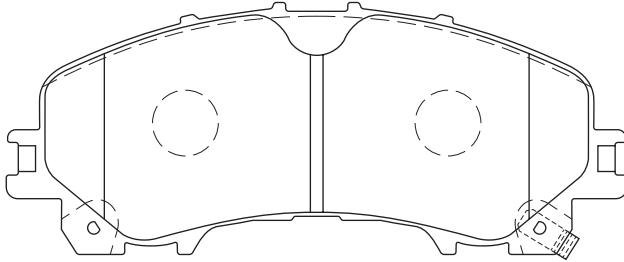
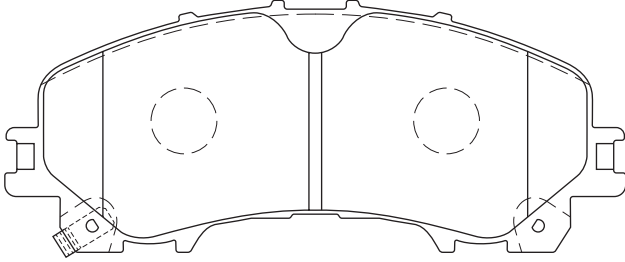
HN-No.	W	H	T	AKNo.	HN-No.	W	H	T	AKNo.
				MKNo.					MKNo.
HN-620	142	59.6	17	AN-793WK					
				D1399					
HN-621						151.3	61.9	15.8	AN-794WK D1336M
									
									
									

HN-No.	W	H	T	AKNo.	HN-No.	W	H	T	AKNo.
				MKNo.					MKNo.
HN-701	164	57	16.8		HN-702	167.3	54.3	16.5	
				D1263-2					
HN-703						130.8	45	16.2	
								D2246M-2	
HN-708	167.6	54.5	16.5		HN-709	140	51.8	15.6	
				D4055-2					D2303-2
HN-710						118.8	67.6	17	
								D2215M-2	

HN-No.	W	H	T	AKNo.	HN-No.	W	H	T	AKNo.
				MKNo.					MKNo.
HN-713						137	57.9	18.2	
						137	61.4	18.2	D2286-2
HN-721	151.8	60.8	15.8						
HN-790						143.2	67.3	17	
HN-834						146.4	53.4	16.4	
									D2260
HN-904	102.5	45.8	14.9						
				D2299					

HN-No.	W	H	T	AKNo.	HN-No.	W	H	T	AKNo.
				MKNo.					MKNo.
HN-905						164.5	63.5	16.9	
									D11236M

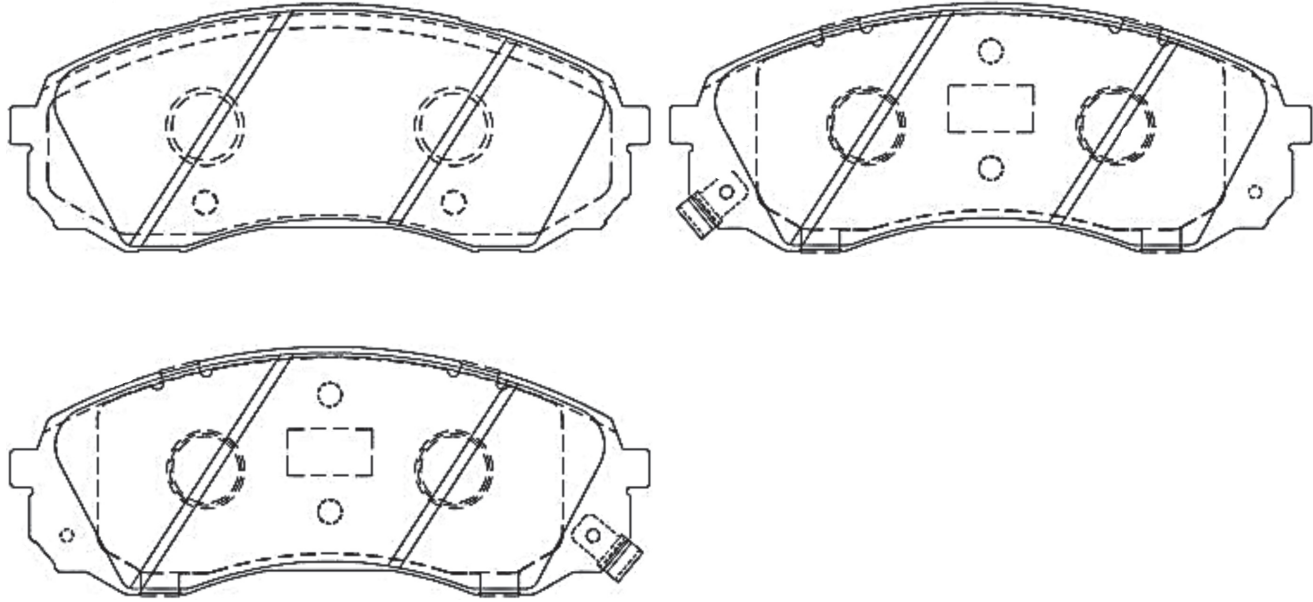

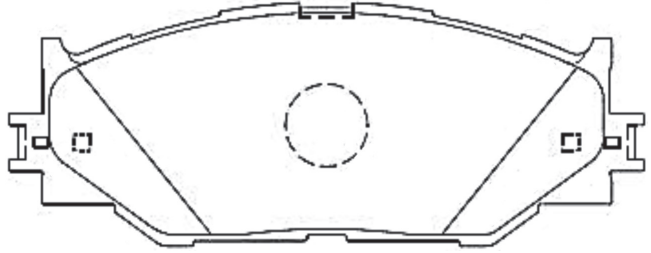
HN-912	154.6	58.9	17.7	D2277
				

HN-913	151.1	57	18.3	D5156
				

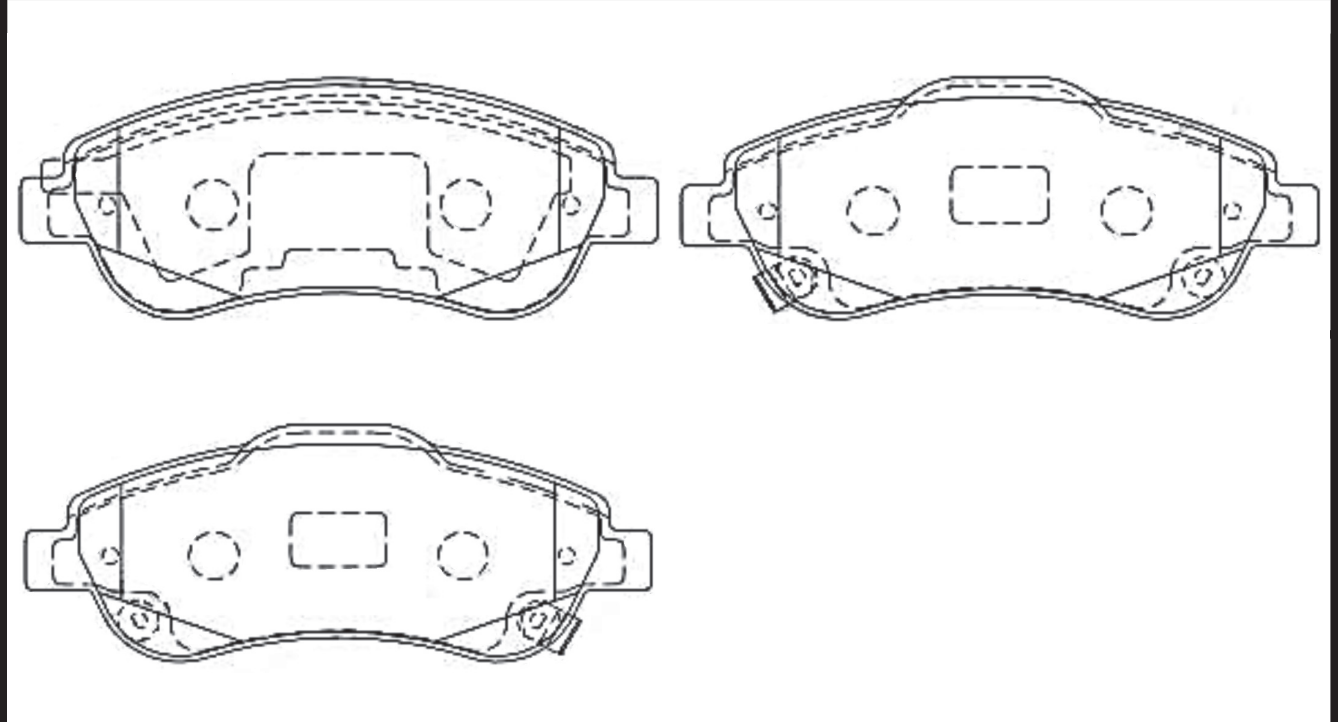

HN-No.	W	H	T	AKNo.	HN-No.	W	H	T	AKNo.	
				MKNo.					MKNo.	
HN-916	139.1	56.4	17							
				D5183						
							93.4	46.7	14.6	
HN-918									D5162	
							142.2	48.3	17	
HN-920							142.2	52.3	17	D1313M
							145	55.3	16	
HN-922				D1213	HN-928		133.6	88.1	18.5	
							156.4	54.9	16.8	
HN-929	96.2	37.6	14.3	D2227	HN-930				D2170	

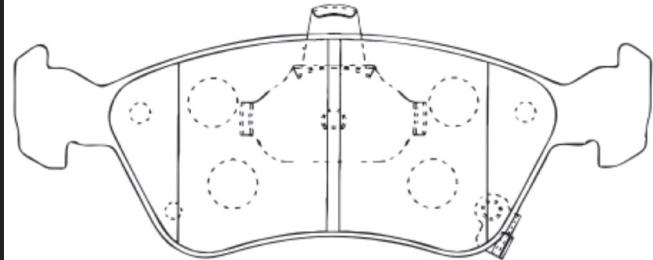
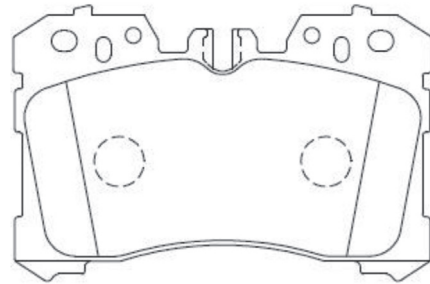
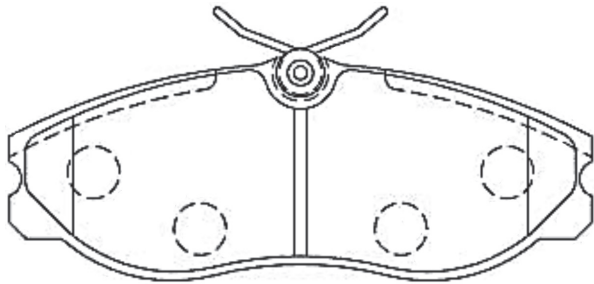
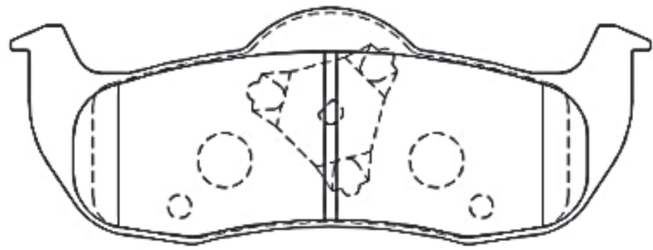
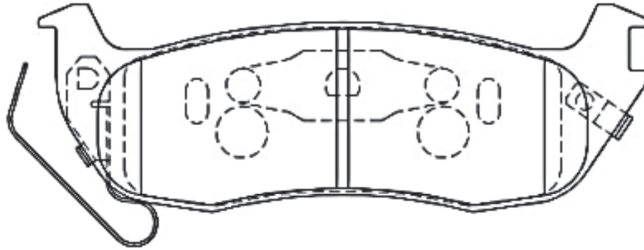
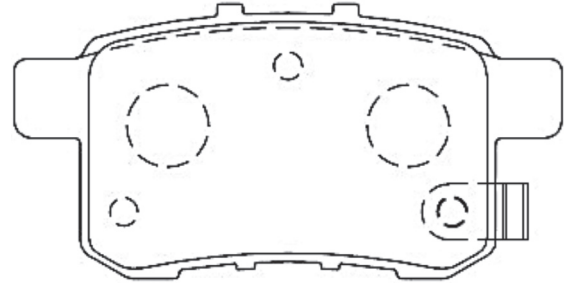
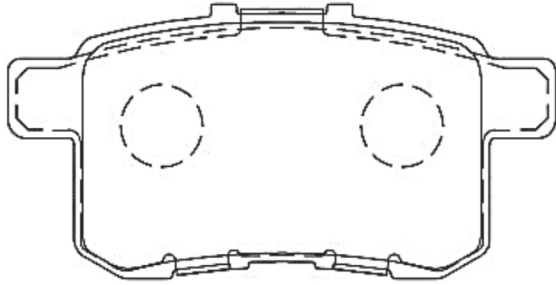
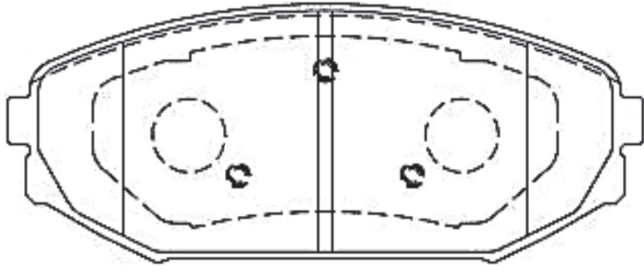

HN-No.	W	H	T	AKNo.	HN-No.	W	H	T	AKNo.
				MKNo.					MKNo.

HN-933						150.8	62.2	17.8	
						150.8	64.2	17.8	D2289M

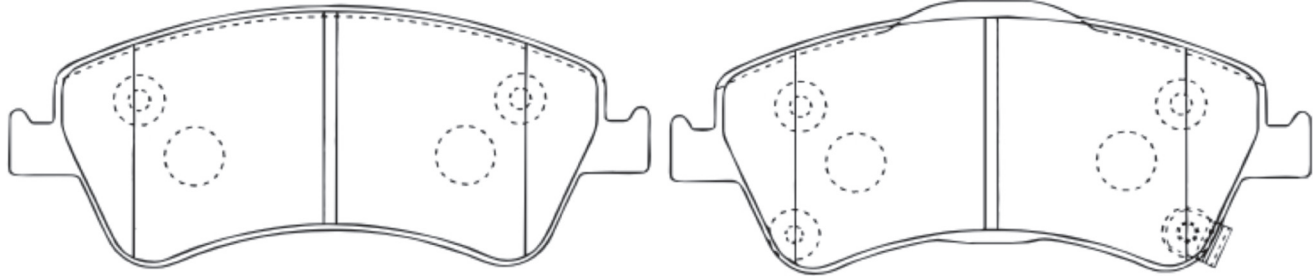

HN-935	108.8	49.4	15.7						
									D2296

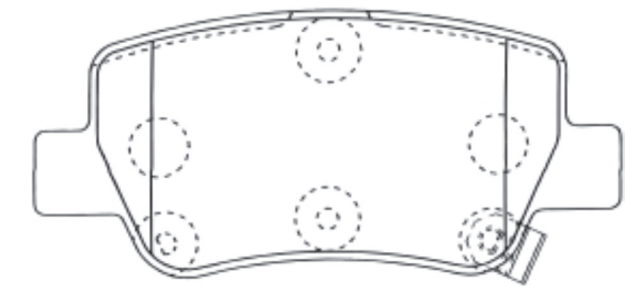

HN-936						158.4	58.8	15.6	
									D1279M

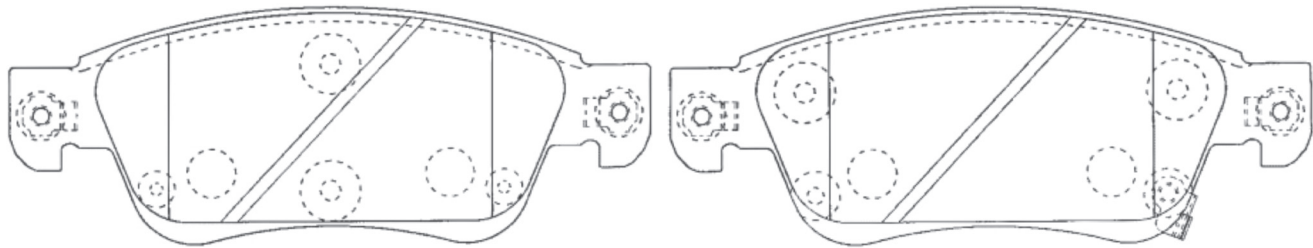



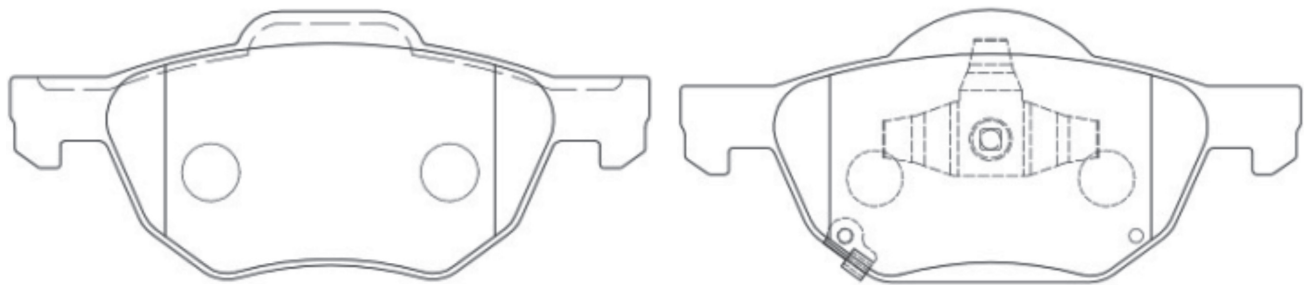

HN-937						155	64.9	16	
						155	68.3	16	D5125M

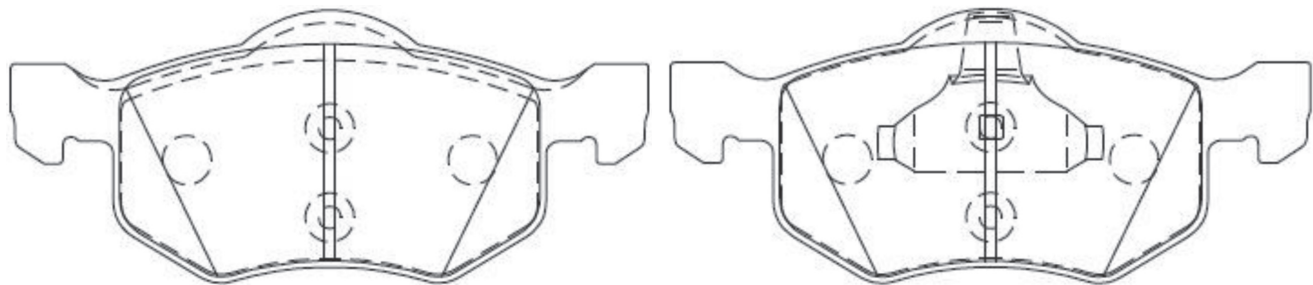

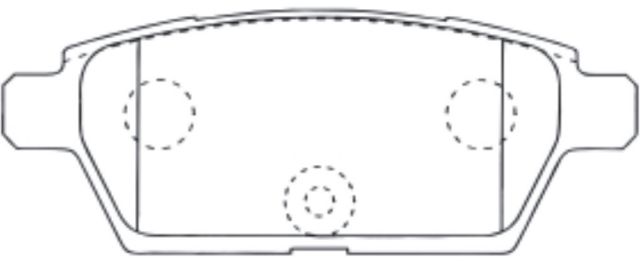
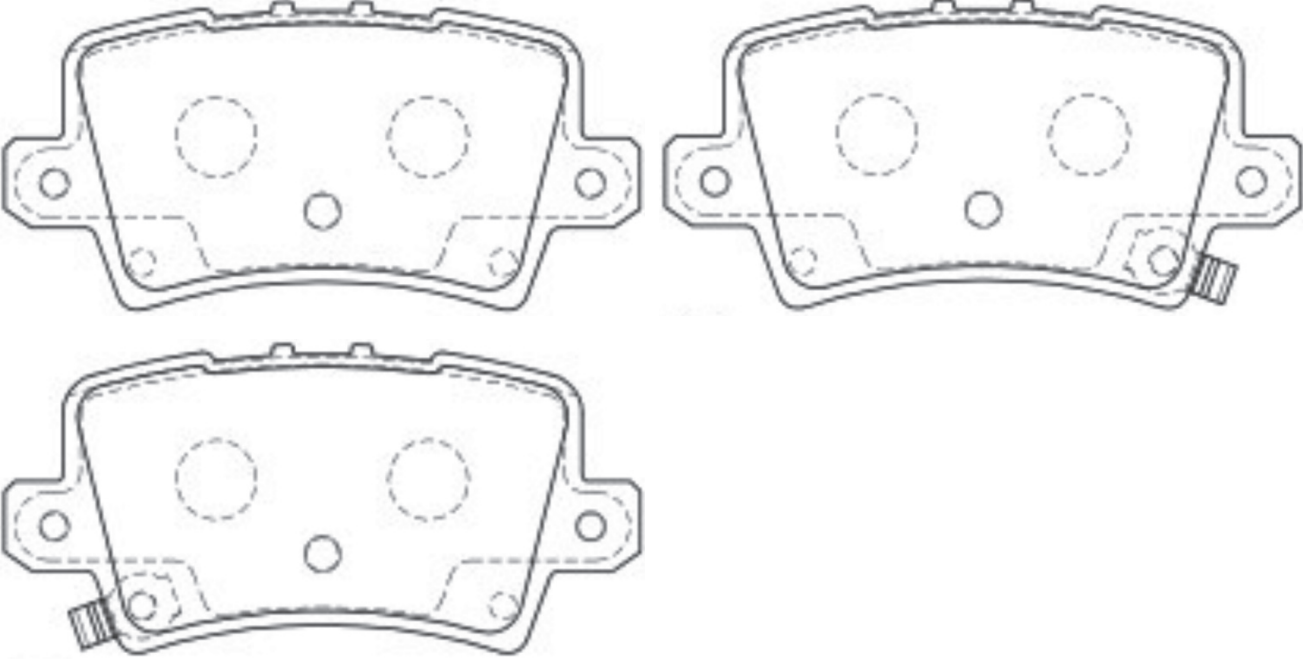
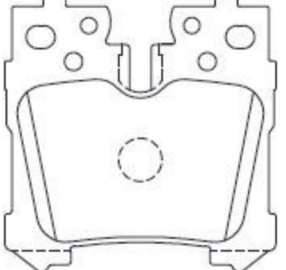
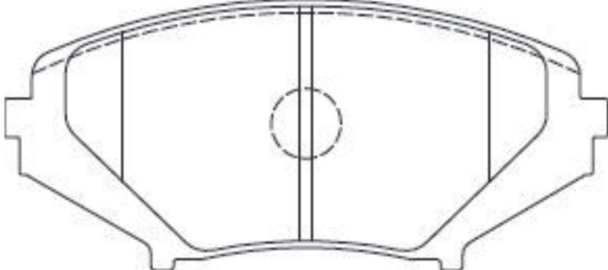
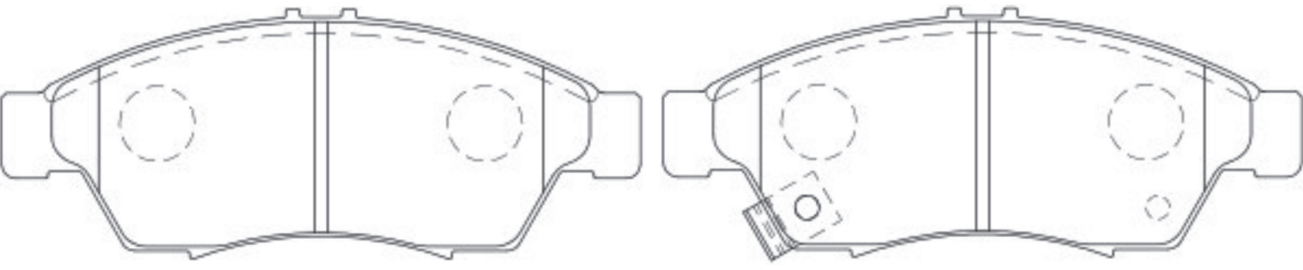
HN-939						156.3	66.6	18.3	
						156.3	66.6	19.3	D3114

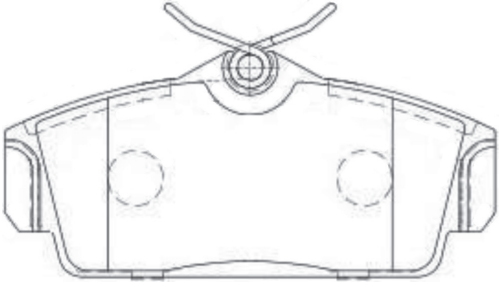
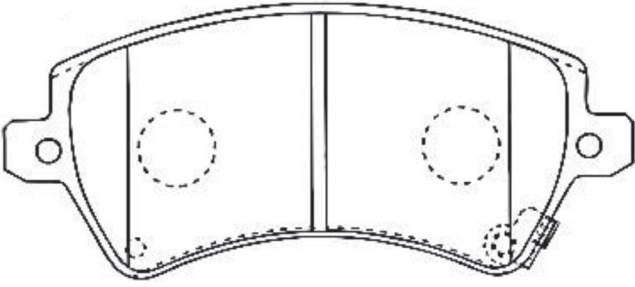
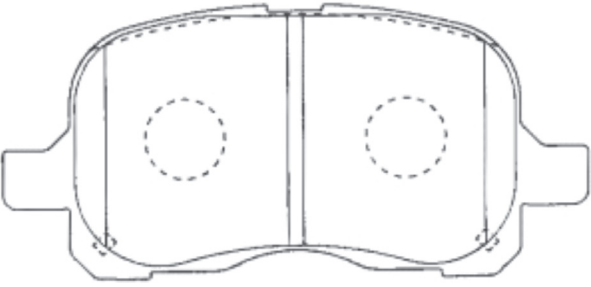
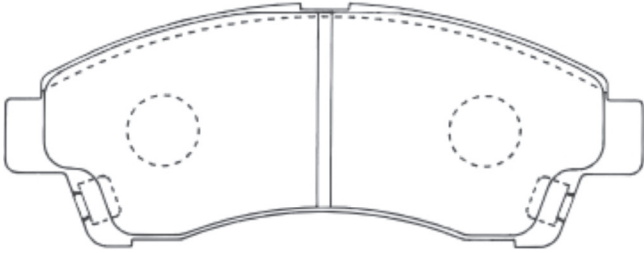

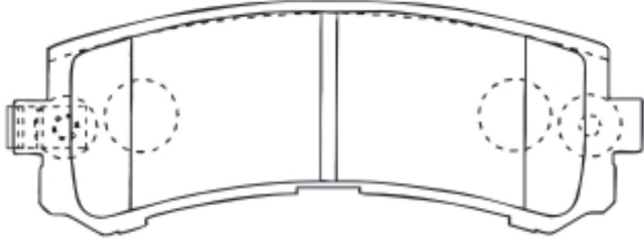
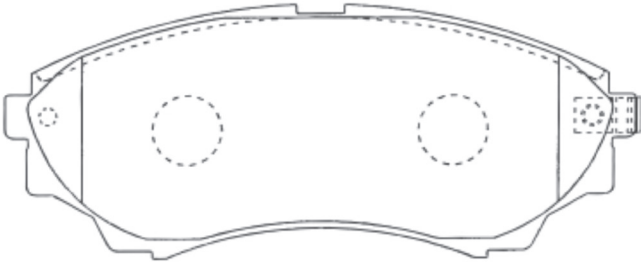
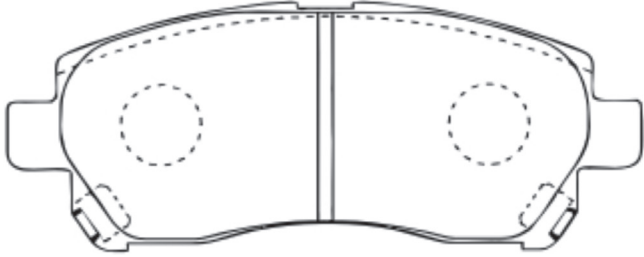
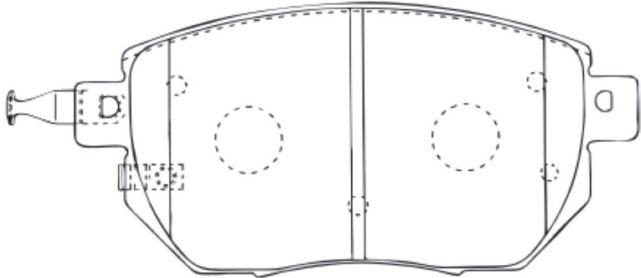
HN-No.	W	H	T	AKNo.	HN-No.	W	H	T	AKNo.
				MKNo.					MKNo.
HN-942	110.6	41.6	14.3						
				D3134					
									
HN-943						96	46.6	15.2	
				D5150M					
									
HN-945	75	76.2	18.4		HN-947	138	62	16.4	
									D9402
									
HN-948						136.5	53.2	17	
				D1230					
									

HN-No.	W	H	T	AKNo.	HN-No.	W	H	T	AKNo.
				MKNo.					MKNo.
HN-950	124	57	16.4		HN-951	131.4	57.4	17.2	
				D2224M					
					Superseded from HN-2224MD				
									
HN-952	116.8	54.8	16.5		HN-953	142.6	54.9	16	
				D3113					
Superseded from HN-353E					Superseded from HN-377E				
									
HN-954	151	51.3	15.7		HN-955	121	45.3	16	
Superseded from HN-431E					Superseded from HN-472E				
									
HN-956	145	58.6	16.2		HN-957	127	49.4	14	
Superseded from HN-517E					Superseded from HN-555E				
									
HN-958	135.4	65.7	14.9		HN-959	116.4	52.4	17.1	
				D1264M					
Superseded from HN-581E					Superseded from HN-586E				
									

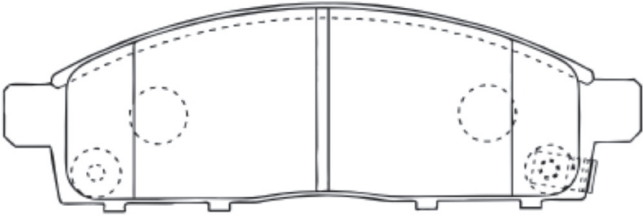
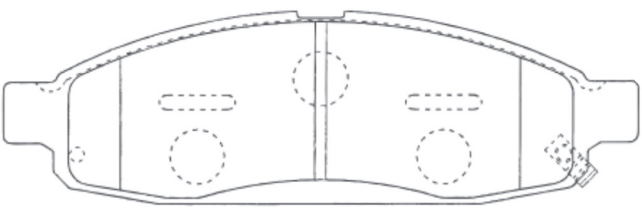
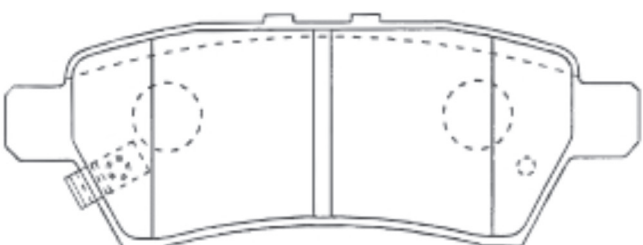
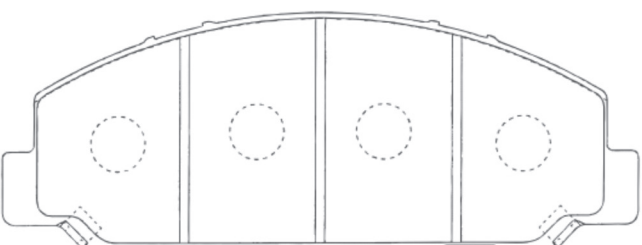
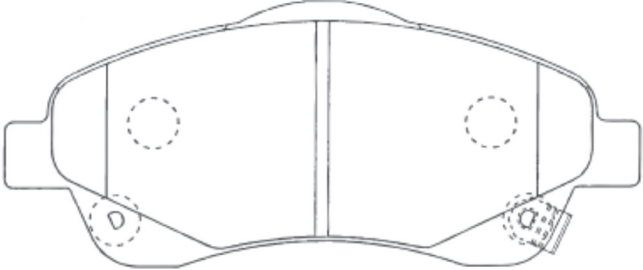
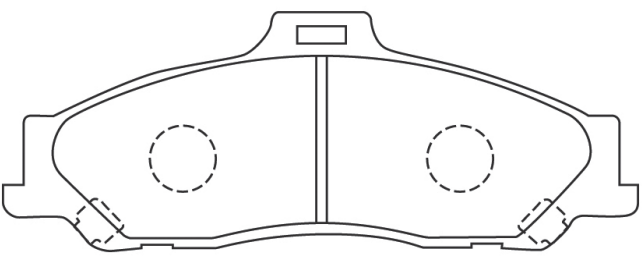
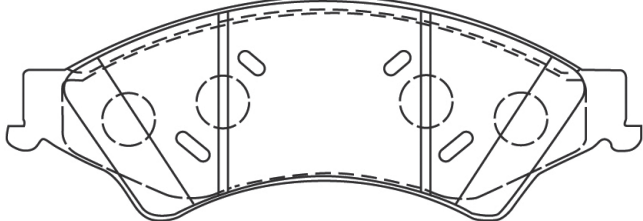
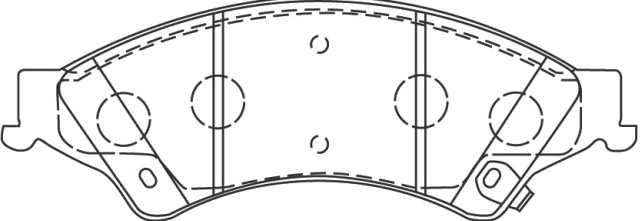
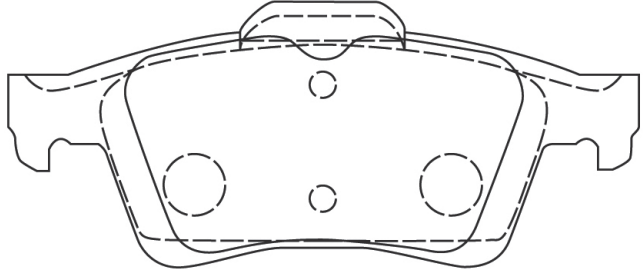
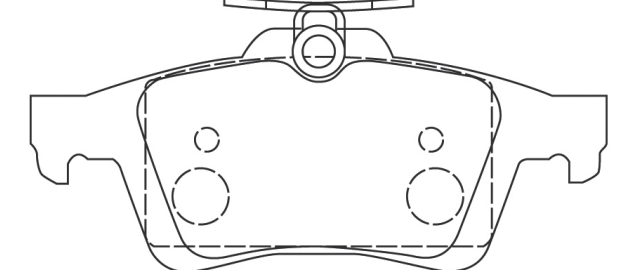
HN-No.	W	H	T	AKNo.	HN-No.	W	H	T	AKNo.
				MKNo.					MKNo.
HN-960	155.4	51	15.7	D6128	HN-961	175.8	53.2	17.5	D1325M
Superseded from HN-615E					Superseded from HN-637E				
									
HN-962	110.4	40.7	15.9	D1272M	HN-963	210	76.7	19.8	
Superseded from HN-657E					Superseded from HN-660E				
									
HN-964	151	63	17.8	D2233M	HN-965	151.2	61	16.1	D3119
Superseded from HN-668E					Superseded from HN-3119D				
									
HN-966					194.2	68	15.4		
					194.2	68	15.4	D3160	
									
HN-967					123.2	51.9	15.7		
Superseded from HN-638E					123.2	51.9	15.7	D3132	
									

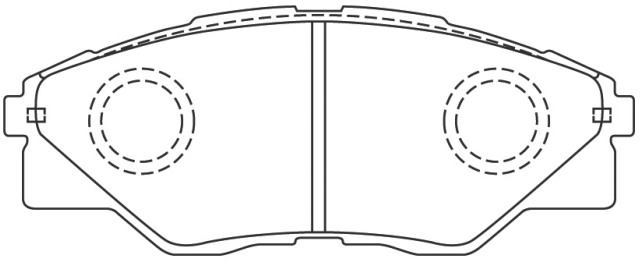
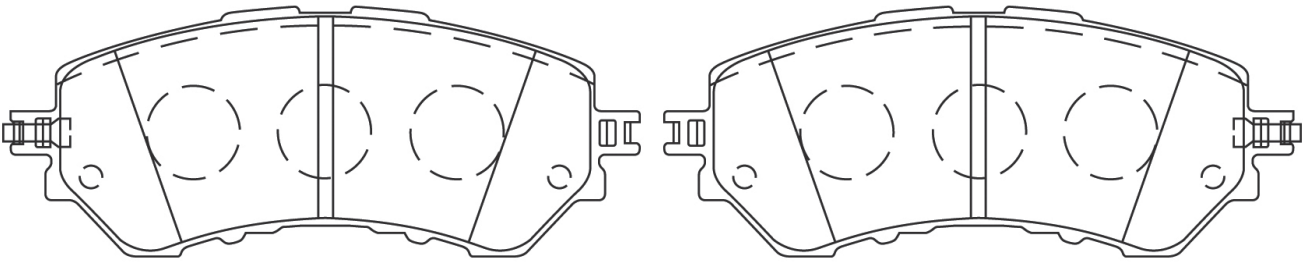
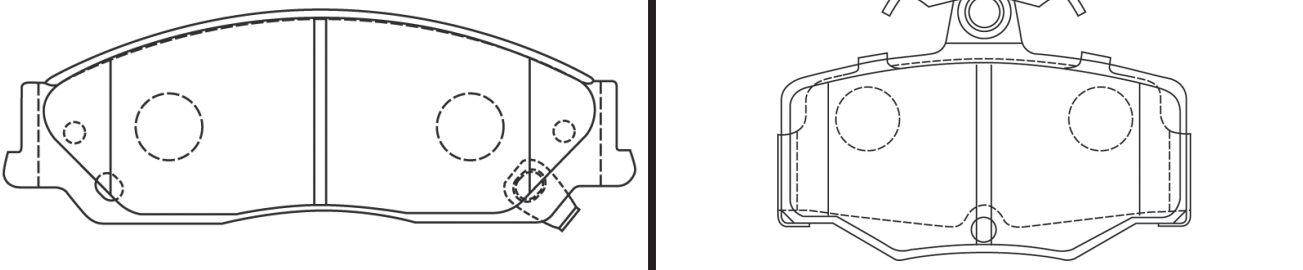
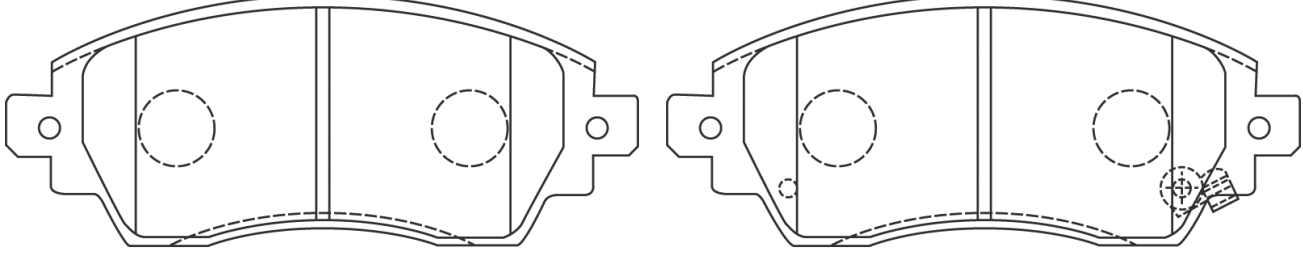
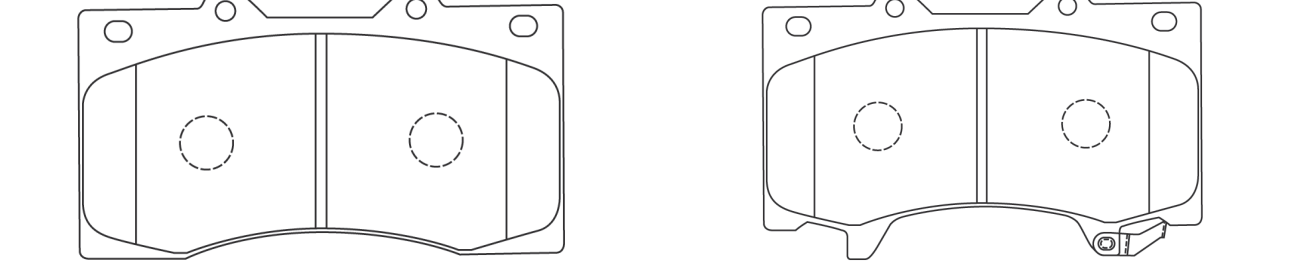
HN-No.	W	H	T	AKNo.	HN-No.	W	H	T	AKNo.
				MKNo.					MKNo.
HN-968	140.4	55.2	15.8						
				D2303					
Superseded from HN-744E									
									
HN-969									
				D2343					
									
HN-970	151.2	51	17.3		HN-971	82.2	56.9	14.9	
				D2304M					D1214H
									
HN-972									
				D2194M					
									
HN-973									
				D1318M					
									

HN-No.	W	H	T	AKNo.	HN-No.	W	H	T	AKNo.				
				MKNo.					MKNo.				
HN-975	141.8	55.7	15.5										
				D1344M									
HN-976													
										151.3	58.5	16.5	
										150.1	61.3	16.5	D2271MH
HN-979													
													D1329M
HN-980	138.2	55	16.4		HN-981	133.1	53.4	17.2					
				D9044									
Superseded from HN-710E													
HN-982	100.8	42.6	15.2										
				D1580M									

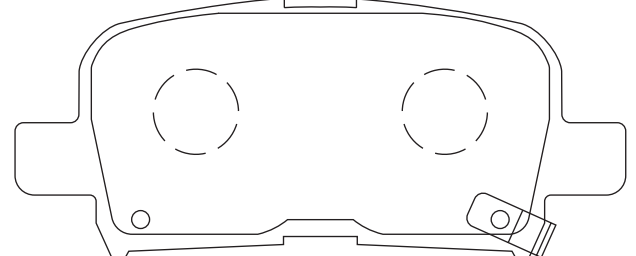
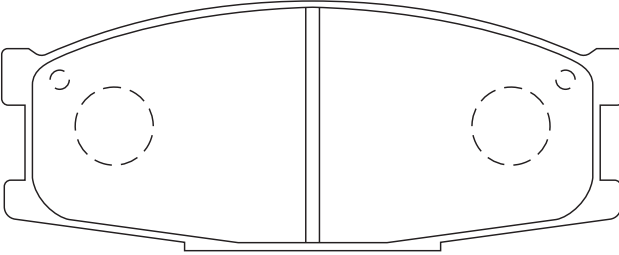
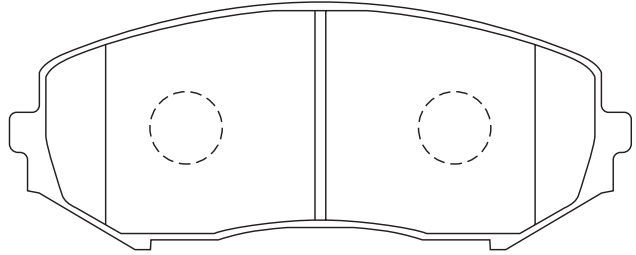
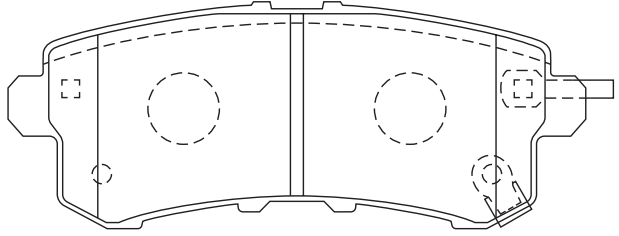
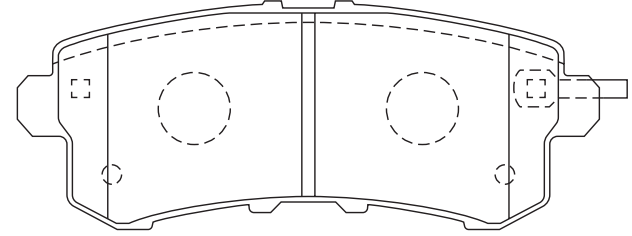
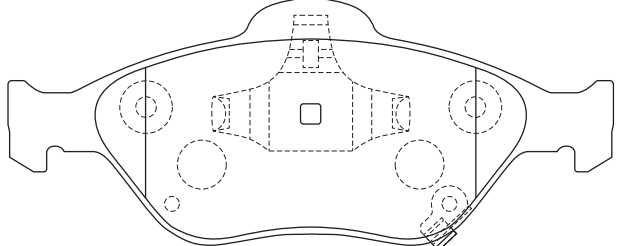
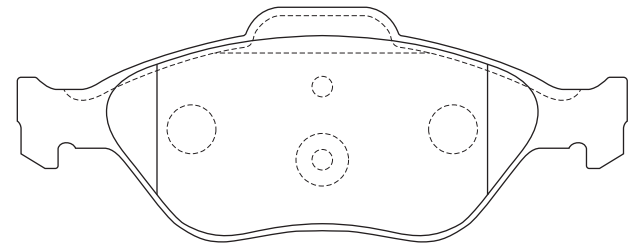
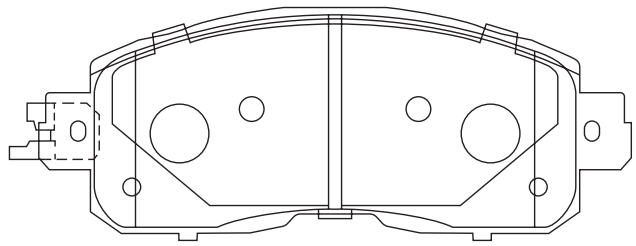

HN-No.	W	H	T	AKNo.	HN-No.	W	H	T	AKNo.
				MKNo.					MKNo.
HN-983						118.6	47	15	
									D11201
HN-984						117.1	48.4	14.5	
									D11280
HN-985						108.8	42.3	15.5	
									D5159
HN-986						93	41	15	
									D11195M
HN-987						98.6	40.7	15	
									D11118M

HN-No.	W	H	T	AKNo.	HN-No.	W	H	T	AKNo.
				MKNo.					MKNo.



BRAKE SHOE ASSY

CROSS REFERENCE

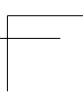
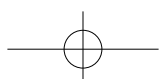
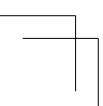
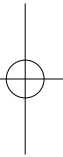
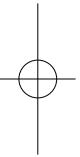
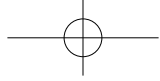
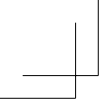

NISSAN-1
Brake Shoe-Cross Reference

Original Parts No.	Mfg. No.	Original Parts No.	Mfg. No.	Original Parts No.	Mfg. No.
36102-61000	FN-1249	41060-H0125	FN-1121	44060-10W25	FN-1163
36110-90004	FN-4413	41060-J5110	FN-1152	44060-16C25	FN-1174
36110-90006	FN-4413	41060-J5125	FN-1152	44060-16C26	FN-1174
36119-Z9006	FN-4413	41060-R8025	FN-1168	44060-18000	FN-1122
36160-0T025	FN-3340	41060-T3226	FN-1159	44060-18025	FN-1122
36160-0T525	FN-1244	41060-T3260	FN-1159	44060-18B25	FN-1164
36160-50T25	FN-1135	41060-T8025	FN-1161	44060-20W25	FN-1162
36160-89TA0	FN-4443	41060-T9625	FN-1161	44060-21B25	FN-1164
36160-89TA1	FN-4404	41060-T9626	FN-1161	44060-25T25	FN-1208
36160-89TA2	FN-4404	41060-T9627	FN-1152	44060-25Y25	FN-1167
36160-89TA3	FN-4443	41060-U9900	FN-1116	44060-28000	FN-1105
36160-L5005	FN-1135	41060-U9925	FN-1116	44060-28025	FN-1105
36160-T1025	FN-1135	41060-V5525	FN-1169	44060-28B25	FN-1164
36160-WK625	FN-4443	41060-V5526	FN-1169	44060-28N25	FN-1174
41060-01D25	FN-1152	41060-W0325	FN-1157	44060-2S425	FN-1174
41060-01D27	FN-1152	41060-W9625	FN-1182	44060-2T025	FN-1210
41060-01T25	FN-1161	41060-W9626	FN-1182	44060-2U025	FN-1204
41060-06D25	FN-1201	41060-W9627	FN-1182	44060-2U625	FN-1198
41060-0T025	FN-1197	41060-W9628	FN-1182	44060-31B25	FN-1164
41060-0T525	FN-1197	41070-28000	FN-1103	44060-31G25	FN-1171
41060-0T912	FN-1201	41070-B3000	FN-1103	44060-35G25	FN-1171
41060-18025	FN-1121	44060-01A00	FN-1160	44060-36700	FN-1105
41060-18V25	FN-1178	44060-01A25	FN-1160	44060-36725	FN-1105
41060-18V29	FN-1178	44060-01B00	FN-1164	44060-37G25	FN-1189
41060-18V85	FN-1178	44060-01B25	FN-1164	44060-37G26	FN-1189
41060-21300	FN-1116	44060-01J25	FN-1179	44060-37G27	FN-1189
41060-21325	FN-1116	44060-01T25	FN-4428	44060-3T025	FN-1179
41060-28000	FN-1103	44060-01W25	FN-1158	44060-3T026	FN-1208
41060-28025	FN-1103	44060-03N25	FN-1171	44060-3T125	FN-1163
41060-28925	FN-1116	44060-03N26	FN-1171	44060-3T126	FN-1163
41060-36725	FN-1103	44060-04A00	FN-1167	44060-41A25	FN-1160
41060-4A0A0	FN-9959	44060-04A25	FN-1167	44060-41A85	FN-1160
41060-53T25	FN-1183	44060-04B25	FN-1164	44060-41B25	FN-1204
41060-76000	FN-1100	44060-05N25	FN-1174	44060-41W25	FN-1158
41060-76025	FN-1100	44060-05W25	FN-1158	44060-47L25	FN-1170
41060-89TA0	FN-4458	44060-06F25	FN-1148	44060-47L26	FN-1170
41060-89TA1	FN-4451	44060-07Y25	FN-1160	44060-48L25	FN-1170
41060-89TA4	FN-4451	44060-08G25	FN-1174	44060-48L26	FN-1170
41060-89TA5	FN-4459	44060-0C025	FN-1198	44060-4A00B	FN-9967
41060-89TB5	FN-4459	44060-0C026	FN-1198	44060-4A0A0	FN-9959
41060-89TB7	FN-4459	44060-0C725	FN-1193	44060-4A0A1	FN-9967
41060-A0800	FN-1116	44060-0C726	FN-1193	44060-4A0A2	FN-9967
41060-A0825	FN-1116	44060-0C727	FN-1193	44060-4A0A3	FN-9967
41060-B3000	FN-1103	44060-0C728	FN-1193	44060-4M425	FN-1167
41060-B3025	FN-1103	44060-0E725	FN-1196	44060-4N025	FN-1193
41060-B8626	FN-1151	44060-0H525	FN-1156	44060-4N026	FN-1193
41060-B9600	FN-1151	44060-0H526	FN-1156	44060-50Y25	FN-1185
41060-B9625	FN-1151	44060-0T025	FN-1197	44060-51E25	FN-1167
41060-G0300	FN-1121	44060-0T325	FN-1202	44060-55L25	FN-1170
41060-G0325	FN-1121	44060-0T925	FN-1201	44060-56G26	FN-1189
41060-G1625	FN-1121	44060-0W725	FN-1189	44060-56L25	FN-1170
41060-G2525	FN-1153	44060-0W726	FN-1189	44060-56L26	FN-1170
41060-G3225	FN-1154	44060-0W727	FN-1189	44060-56L27	FN-1170

NISSAN-2 Brake Shoe-Cross Reference

Original Parts No.	Mfg. No.	Original Parts No.	Mfg. No.	Original Parts No.	Mfg. No.
44060-5T525	FN-1210	44060-E0425	FN-1140	44060-T6225	FN-1163
44060-5T625	FN-1163	44060-E3025	FN-1140	44060-T6226	FN-1163
44060-5V025	FN-1170	44060-E3200	FN-1140	44060-T6425	FN-1146A
44060-5V026	FN-1170	44060-E3225	FN-1140	44060-T8225	FN-4428
44060-5V225	FN-1193	44060-EB325	—	44060-U8700	FN-1148
44060-5V226	FN-1193	44060-ED025	FN-1267	44060-U8725	FN-1148
44060-5V525	FN-1240	44060-ED026	FN-1267	44060-V0225	FN-1156
44060-60A25	FN-1167	44060-EN025	FN-1264	44060-V0329	FN-1177
44060-60R25	FN-1185	44060-EN026	FN-1264	44060-V0500	FN-1156
44060-60Y25	FN-1170	44060-F4125	FN-1185	44060-V0525	FN-1156
44060-64J25	FN-1167	44060-G0300	FN-1122	44060-V0600	FN-1156
44060-65E25	FN-1170	44060-G0325	FN-1122	44060-V0625	FN-1156
44060-68A25	FN-1160	44060-G1225	FN-1149	44060-V4025	FN-11093A
44060-69E25	FN-1167	44060-G2200	FN-1122	44060-V4026	FN-11093A
44060-6A00E	FN-6723	44060-G2225	FN-1122	44060-VE425	FN-1174
44060-6A00F	FN-6723	44060-G3225	FN-1166	44060-VE426	FN-1174
44060-6A00H	FN-6723	44060-G9825	FN-1208	44060-W0300	FN-1148
44060-6A0A0	FN-6726	44060-H0100	FN-1122	44060-W0325	FN-1148
44060-6A0A1	FN-6729	44060-H0125	FN-1122	44060-WK625	FN-6653
44060-6A0A2	FN-6729	44060-H7025	FN-1149	44066-89TA1	FN-4428
44060-6A0A3	FN-6729	44060-H7225	FN-1122	44066-99001	FN-4413
44060-6A0A7	FN-6729	44060-H8725	FN-1149	44070-E3200	FN-1140
44060-6A0B1	FN-6729	44060-H9400	FN-1149	44070-G0300	FN-1122
44060-6H085	FN-1170	44060-H9425	FN-1149	44070-T0400	FN-1146
44060-70N25	FN-1170	44060-HA025	FN-3410	4600A-027	FN-1267
44060-7E625	FN-1223	44060-HA026	FN-3410	AY360-KE029	FN-6726
44060-85E25	FN-1170	44060-HA027	FN-3426	AY360-NS042	FN-1208
44060-85E26	FN-1170	44060-HC025	FN-3348	AY360-NS087	FN-1163
44060-86R25	FN-1198	44060-HC026	FN-3348	AY360-NS088	FN-1210
44060-89TA0	FN-4447	44060-HC056	FN-3348	AY360-NS089	FN-1261
44060-89TA1	FN-4428	44060-HC525	FN-3351	AY360-NS091	FN-1170
44060-89TA2	FN-4459	44060-HC526	FN-3351	AY360-NS093	FN-1198
44060-89TA5	FN-4459	44060-HC556	FN-3351	AY360-NS095	FN-1267
44060-89TA6	FN-4447	44060-HC625	FN-3350	AY360-NS096	FN-1264
44060-89TA7	FN-4451	44060-HC656	FN-3350	AY360-NS097	FN-1170
44060-89TA8	FN-4451	44060-J6400	FN-4428	AY360-NS103	FN-1264
44060-89TB0	FN-4465	44060-J6425	FN-4428	AY360-NS136	FN-2297
44060-89TB1	FN-4447	44060-L7025	FN-1160	C6160-50T25	FN-1135
44060-89TB2	FN-4465	44060-L7026	FN-1160	D1060-18V25	FN-1178
44060-89TB3	FN-4461	44060-L7027	FN-1160	D1060-18V26	FN-1178
44060-89TB4	FN-4451	44060-M4900	FN-1149	D1060-B3000	FN-1103
44060-89TB5	FN-4451	44060-M4925	FN-1149	D1060-B3025	FN-1103
44060-89TB7	FN-4461	44060-M7000	FN-1149	D1060-B9600	FN-1151
44060-98E25	FN-1170	44060-M7025	FN-1149	D1060-B9625	FN-1151
44060-AX026	FN-1261	44060-P0525	FN-1140	D1060-G0300	FN-1121
44060-AX425	FN-1198	44060-P5100	FN-1140	D1060-G0325	FN-1121
44060-B3000	FN-1105	44060-P5125	FN-1140	D1060-G2500	FN-1153
44060-B3025	FN-1105	44060-Q0101	FN-1148	D1060-G2525	FN-1153
44060-B8600	FN-1105	44060-Q0125	FN-1148	D1060-G3200	FN-1154
44060-B8625	FN-1105	44060-Q1325	FN-1148	D1060-G3225	FN-1154
44060-D0125	FN-1149	44060-T0400	FN-1146	D1060-J5110	FN-1152
44060-D5525	FN-1174	44060-T0425	FN-1146	D1060-J5125	FN-1152
44060-D5725	FN-1170	44060-T6025	FN-1162	D1060-R8010	FN-1168

NISSAN-3 Brake Shoe-Cross Reference

Original Parts No.	Mfg. No.	Original Parts No.	Mfg. No.	Original Parts No.	Mfg. No.
D1060-T3285	FN-1159	D4060-Q0101	FN-1148	DD060-05N25	FN-1174
D1060-T8025	FN-1161	D4060-Q0125	FN-1148	DD060-56G26	FN-1189
D1060-U9925	FN-1116	D4060-T6000	FN-1162		
D1060-W9612	FN-1182	D4060-T6025	FN-1162		
D1060-W9621	FN-1182	D4060-T6200	FN-1163		
D1060-W9627	FN-1182	D4060-T6225	FN-1163		
D1060-W9628	FN-1182	D4060-T6400	FN-1146A		
D1070-B3000	FN-1103	D4060-T6425	FN-1146A		
D1070-B9600	FN-1151	D4060-U8700	FN-1148		
D4060-01A00	FN-1160	D4060-U8725	FN-1148		
D4060-01A25	FN-1160	D4060-V0225	FN-1156		
D4060-01B00	FN-1164	D4060-V0500	FN-1156		
D4060-01B25	FN-1164	D4060-V0525	FN-1156		
D4060-01W00	FN-1158	D4060-V0600	FN-1156		
D4060-01W25	FN-1158	D4060-V0601	FN-1156		
D4060-04A00	FN-1167	D4060-V0625	FN-1156		
D4060-04A25	FN-1167	D4060-V0626	FN-1156		
D4060-0H510	FN-1156	D4060-V5000	FN-1156		
D4060-0H525	FN-1156	D4060-W0300	FN-1148		
D4060-18025	FN-1122	D4060-W0301	FN-1148		
D4060-21B10	FN-1164	D4060-W0325	FN-1148		
D4060-21B25	FN-1164	D4060-W0326	FN-1148		
D4060-28B10	FN-1164	D4060-WE90A	FN-1170		
D4060-28B25	FN-1164	D4070-01A00	FN-1160		
D4060-41W25	FN-1158	D4070-01B00	FN-1164		
D4060-47L10	FN-1170	D4070-01W00	FN-1158		
D4060-47L11	FN-1170	D4070-04A00	FN-1167		
D4060-47L25	FN-1170	D4070-0H510	FN-1156		
D4060-47L26	FN-1170	D4070-21B10	FN-1164		
D4060-48L10	FN-1170	D4070-28B10	FN-1164		
D4060-48L11	FN-1170	D4070-47L10	FN-1170		
D4060-48L25	FN-1170	D4070-47L11	FN-1170		
D4060-48L26	FN-1170	D4070-48L10	FN-1170		
D4060-51E10	FN-1167	D4070-48L11	FN-1170		
D4060-56L11	FN-1170	D4070-51E10	FN-1167		
D4060-56L13	FN-1170	D4070-56L11	FN-1170		
D4060-56L25	FN-1170	D4070-56L13	FN-1170		
D4060-70N10	FN-1170	D4070-70N10	FN-1170		
D4060-B3000	FN-1105	D4070-B3000	FN-1105		
D4060-B3025	FN-1105	D4070-E3200	FN-1140		
D4060-B8600	FN-1105	D4070-G3260	FN-1166		
D4060-D0100	FN-1149	D4070-H8700	FN-1149		
D4060-D0125	FN-1149	D4070-M4900	FN-1149		
D4060-E3200	FN-1140	D4070-N4600	FN-1148		
D4060-ED026	FN-1267	D4070-Q0101	FN-1148		
D4060-EN00A	FN-1264	D4070-T6000	FN-1162		
D4060-G0300	FN-1122	D4070-T6200	FN-1163		
D4060-G3260	FN-1166	D4070-T6400	FN-1146A		
D4060-H8700	FN-1149	D4070-V0500	FN-1156		
D4060-H8725	FN-1149	D4070-V0600	FN-1156		
D4060-M4900	FN-1149	D4070-V0601	FN-1156		
D4060-M4925	FN-1149	D4070-W0300	FN-1148		
D4060-M7025	FN-1149	D4070-W0301	FN-1148		

TOYOTA-1 Brake Shoe-Cross Reference

Original Parts No.	Mfg. No.	Original Parts No.	Mfg. No.	Original Parts No.	Mfg. No.
04047-10070	FN-2290	04494-30031	FN-2251	04495-12070	FN-2232
04047-12010	FN-2203	04494-36040	FN-2263	04495-12080	FN-2288
04047-12061	FN-2288	04494-36041	FN-2263	04495-12081	FN-2288
04047-12070	FN-2288	04494-36042	FN-2263	04495-12082	FN-2311
04047-14010	FN-2232	04494-36050	FN-2265	04495-12090	FN-2288
04047-14020	FN-2232	04494-36060	FN-2291	04495-12091	FN-2311
04047-14030	FN-2284	04494-36061	FN-2294	04495-12100	FN-2311
04047-16020	FN-2287	04494-36062	FN-2291	04495-12101	FN-2311
04047-16030	FN-2289	04494-36070	FN-2292	04495-12110	FN-2311
04047-20030	FN-2232	04494-36080	FN-2296	04495-12111	FN-2311
04047-20040	FN-2232	04494-36090	FN-2297	04495-12130	FN-2313
04047-20071	FN-2285	04494-36100	FN-2294	04495-12131	FN-2313
04047-20091	FN-2285	04494-36140	FN-2294	04495-12140	FN-2313
04047-22030	FN-2232	04494-36141	FN-2294	04495-12141	FN-2313
04047-22041	FN-2232	04494-36150	FN-2297	04495-12150	FN-2313
04047-26050	FN-2282	04494-36160	FN-2296	04495-12170	FN-2311
04047-26051	FN-2282	04494-36170	FN-2292	04495-12171	FN-2311
04047-26060	FN-2252	04494-36180	FN-2329	04495-12181	FN-2313
04047-26070	FN-2305	04494-36190	FN-2329	04495-12210	FN-2311
04047-28040	FN-2252	04494-36210	FN-2329	04495-12220	FN-2285
04047-30050	FN-2252	04494-36280	FN-2296	04495-12221	FN-2285
04047-30061	FN-2252	04494-36290	FN-2329	04495-12230	FN-2313
04494-10010	FN-2237A	04494-36300	FN-2329	04495-12231	FN-2203
04494-10011	FN-2237A	04494-60020	FN-2255	04495-12240	FN-2311
04494-10020	FN-2237A	04494-60021	FN-2255	04495-12250	FN-2285
04494-10030	FN-2237A	04495-01030	FN-2311	04495-13010	FN-2311
04494-11010	FN-2237A	04495-0K010	FN-2335	04495-14010	FN-2232
04494-12010	FN-2202	04495-0K020	FN-2395	04495-14011	FN-2232
04494-12040	FN-2202	04495-10010	FN-2237B	04495-14020	FN-2232
04494-12050	FN-2202	04495-10020	FN-2237B	04495-14021	FN-2232
04494-20011	FN-2210	04495-10030	FN-2254	04495-14030	FN-2232
04494-20020	FN-2210	04495-10031	FN-2289	04495-14031	FN-2232
04494-20021	FN-2210	04495-10040	FN-2254	04495-14040	FN-2284
04494-20110	FN-2267	04495-10041	FN-2254	04495-14041	FN-2284
04494-20120	FN-2267	04495-10042	FN-2289	04495-16010	FN-2262
04494-20121	FN-2267	04495-10050	FN-2262	04495-16011	FN-2262
04494-20130	FN-2267	04495-10060	FN-2262	04495-16020	FN-2287
04494-25010	FN-2239	04495-10061	FN-2262	04495-16021	FN-2287
04494-25011	FN-2239	04495-10070	FN-2290	04495-16022	FN-2287
04494-25012	FN-2239	04495-10071	FN-2290	04495-16023	FN-2236
04494-25020	FN-2275	04495-10080	FN-2290	04495-16030	FN-2289
04494-25030	FN-2294	04495-10081	FN-2290	04495-16031	FN-2289
04494-25040	FN-2286	04495-10100	FN-2290	04495-16050	FN-2289
04494-25050	FN-2275	04495-10101	FN-2290	04495-16051	FN-2289
04494-25060	FN-2275	04495-10110	FN-2321	04495-16060	FN-2289
04494-25080	FN-2275	04495-10120	FN-2321	04495-16061	FN-2289
04494-26030	FN-2256	04495-12010	FN-2203	04495-16080	FN-2236
04494-26040	FN-2256	04495-12011	FN-2203	04495-16090	FN-2321
04494-26060	FN-2251	04495-12030	FN-2237B	04495-20020	FN-2210
04494-26070	FN-2256	04495-12040	FN-2237B	04495-20030	FN-2232
04494-28020	FN-2267	04495-12050	FN-2203	04495-20031	FN-2232
04494-30010	FN-2249	04495-12060	FN-2203	04495-20050	FN-2232
04494-30030	FN-2251	04495-12061	FN-2203	04495-20051	FN-2232

TOYOTA-2 Brake Shoe-Cross Reference

Original Parts No.	Mfg. No.	Original Parts No.	Mfg. No.	Original Parts No.	Mfg. No.
04495-20060	FN-2268	04495-26190	FN-2330	04495-35071	FN-2263
04495-20061	FN-2268	04495-26220	FN-2330	04495-35080	FN-2260
04495-20070	FN-2268	04495-26240	FN-2378	04495-35081	FN-2260
04495-20071	FN-2268	04495-27010	FN-2269	04495-35090	FN-2260
04495-20080	FN-2232	04495-27011	FN-2269	04495-35100	FN-2260
04495-20081	FN-2232	04495-27012	FN-2269	04495-35101	FN-2260
04495-20090	FN-2285	04495-27040	FN-2232	04495-35111	FN-2302
04495-20091	FN-2285	04495-27041	FN-2232	04495-35120	FN-2260
04495-20092	FN-2285	04495-27050	FN-2232	04495-35121	FN-2260
04495-20100	FN-2285	04495-27051	FN-2232	04495-35122	FN-2260
04495-20101	FN-2285	04495-27060	FN-2282A	04495-35130	FN-2282A
04495-20120	FN-2285	04495-28040	FN-2252	04495-35131	FN-2282A
04495-20121	FN-2285	04495-28041	FN-2252	04495-35140	FN-2260
04495-20150	FN-2285	04495-28050	FN-2252	04495-35141	FN-2260
04495-20160	FN-2268	04495-28051	FN-2252	04495-35150	FN-2305
04495-20190	FN-2338	04495-28060	FN-2252	04495-35151	FN-2305
04495-22030	FN-2232	04495-28061	FN-2252	04495-35160	FN-2282A
04495-22031	FN-2232	04495-28071	FN-2252	04495-35170	FN-2282A
04495-22040	FN-2284	04495-28080	FN-2335A	04495-35180	FN-2260
04495-22041	FN-2284	04495-28090	FN-2335	04495-35200	FN-2330
04495-22050	FN-2232	04495-28100	FN-2339	04495-35230	FN-2305
04495-22051	FN-2232	04495-28111	FN-2335A	04495-35240	FN-2330
04495-22080	FN-2232	04495-28120	FN-2335A	04495-36050	FN-2266
04495-22081	FN-2232	04495-28150	FN-2371	04495-36051	FN-2266
04495-22090	FN-2232	04495-28151	FN-2371	04495-36060	FN-2266
04495-25020	FN-2286	04495-28160	FN-2339	04495-36070	FN-2295
04495-25031	FN-2300	04495-28170	FN-2335A	04495-36080	FN-2295
04495-25050	FN-2297	04495-30050	FN-2252	04495-36090	FN-2295
04495-25080	FN-2362	04495-30051	FN-2252	04495-36110	FN-2295
04495-25090	FN-2366	04495-30060	FN-2252	04495-36120	FN-2295
04495-25100	FN-2330	04495-30070	FN-2252	04495-36121	FN-2295
04495-25120	FN-2305	04495-30071	FN-2252	04495-37030	FN-2329
04495-25130	FN-2297	04495-30072	FN-2252	04495-37040	FN-2329
04495-26020	FN-2259	04495-30073	FN-2252	04495-40020	FN-2282
04495-26021	FN-2259	04495-30080	FN-2252	04495-40021	FN-2282
04495-26030	FN-2276	04495-30081	FN-2252	04495-42010	FN-2333
04495-26031	FN-2276	04495-30090	FN-2252	04495-42030	FN-2333
04495-26040	FN-2260	04495-32010	FN-2285	04495-42040	FN-2333
04495-26041	FN-2282	04495-32011	FN-2285	04495-42070	FN-2333
04495-26050	FN-2305	04495-32030	FN-2285	04495-43010	FN-2333
04495-26051	FN-2305	04495-32031	FN-2285	04495-43020	FN-2232
04495-26060	FN-2305	04495-32050	—	04495-43040	FN-2333
04495-26061	FN-2305	04495-34010	FN-2305	04495-43060	FN-2252
04495-26080	FN-2282	04495-34020	FN-2280	04495-43070	FN-2363
04495-26090	FN-2282A	04495-35030	FN-2263	04495-43100	FN-2232
04495-26091	FN-2282A	04495-35031	FN-2240	04495-44010	FN-2339
04495-26100	FN-2305	04495-35041	FN-2240	04495-44020	FN-2339
04495-26120	FN-2282	04495-35050	FN-2260	04495-46010	FN-2311
04495-26121	FN-2282	04495-35051	FN-2260	04495-47010	FN-2342
04495-26130	FN-2317	04495-35052	FN-2260	04495-52010	FN-2350
04495-26140	FN-2317	04495-35060	FN-2282A	04495-52020	FN-2342
04495-26170	FN-2276	04495-35061	FN-2282A	04495-52030	FN-2358
04495-26180	FN-2330	04495-35070	FN-2263	04495-52040	FN-2342

TOYOTA-3 Brake Shoe-Cross Reference

Original Parts No.	Mfg. No.	Original Parts No.	Mfg. No.	Original Parts No.	Mfg. No.
04495-52090	FN-2383	04496-26020	FN-2256	04497-20090	FN-2285
04495-52100	FN-2383	04496-26030	FN-2256	04497-20091	FN-2285
04495-52110	FN-2389	04496-28020	FN-2267	04497-20100	FN-2285
04495-52120	FN-2389	04496-30030	FN-2251	04497-22031	FN-2284
04495-59010	FN-2350	04496-36040	FN-2263	04497-22041	FN-2232
04495-60010	FN-2280	04496-36041	FN-2263	04497-22050	FN-2232
04495-60011	FN-2280	04496-36060	FN-2291	04497-25020	FN-2286
04495-60020	FN-2279	04496-36061	FN-2294	04497-25040	FN-2300
04495-60030	FN-2280	04496-36070	FN-2292	04497-26020	FN-2259
04495-60031	FN-2280	04496-36080	FN-2296	04497-26030	FN-2260
04495-60040	FN-2282	04496-36090	FN-2297	04497-26040	FN-2276
04495-60041	FN-2282	04496-36100	FN-2294	04497-26041	FN-2276
04495-60050	FN-2280	04497-10010	FN-2237B	04497-26050	FN-2282
04495-60051	FN-2280	04497-10030	FN-2254	04497-26051	FN-2282
04495-60060	FN-2280	04497-10040	FN-2262	04497-26060	FN-2282A
04495-60070	FN-2280	04497-10060	FN-2262	04497-26061	FN-2282A
04495-63010	FN-2358	04497-10061	FN-2262	04497-26070	FN-2305
04495-63011	FN-2358	04497-10071	FN-2290	04497-26071	FN-2305
04495-87401	FN-2333	04497-10090	FN-2321	04497-26080	FN-2317
04495-87402	FN-2339	04497-12010	FN-2203	04497-26090	FN-2305
04495-87601	FN-0022	04497-12011	FN-2203	04497-27030	FN-2232
04495-87602	FN-0022	04497-12041	FN-2203	04497-28040	FN-2252
04495-97201	—	04497-12061	FN-2288	04497-28041	FN-2252
04495-97202	FN-0020	04497-12062	FN-2288	04497-30050	FN-2252
04495-97203	FN-0036	04497-12070	FN-2288	04497-30051	FN-2252
04495-97204	FN-0036	04497-12071	FN-2311	04497-30061	FN-2252
04495-97206	FN-0037	04497-12080	FN-2311	04497-30062	FN-2252
04495-97208	FN-0037	04497-12090	FN-2313	04497-30070	FN-2252
04495-97217	FN-0030	04497-12100	FN-2313	04497-32011	FN-2285
04495-97218	FN-0042	04497-12110	FN-2311	04497-35030	FN-2263
04495-97501	FN-0041	04497-12120	FN-2285	04497-35031	FN-2263
04495-B1010	FN-0042	04497-12130	FN-2313	04497-35041	FN-2260
04495-B1050	FN-0041	04497-14010	FN-2232	04497-35061	FN-2302
04495-B1080	FN-0042	04497-14011	FN-2232	04497-35070	FN-2260
04495-B1140	FN-2397	04497-14021	FN-2232	04497-36050	FN-2266
04495-B2080	FN-0037	04497-14031	FN-2284	04497-36060	FN-2266
04495-B2140	FN-0030	04497-16010	FN-2262	04497-36070	FN-2295
04495-B2160	FN-2397	04497-16011	FN-2262	04497-36080	FN-2295
04495-B2210	FN-0043	04497-16020	FN-2287	04497-36090	FN-2295
04495-B4010	FN-2339	04497-16021	FN-2287	04497-60010	FN-2280
04495-B4030	FN-2329	04497-16030	FN-2289	46530-25020	FN-0015
04495-BZ100	FN-2398	04497-16031	FN-2289	46530-36010	FN-0015
04496-10010	FN-2237A	04497-20030	FN-2232	46530-36020	FN-2257
04496-10020	FN-2237A	04497-20031	FN-2232	46530-37030	FN-0015
04496-10030	FN-2237A	04497-20040	FN-2268	46530-60010	FN-2257
04496-11010	FN-2237A	04497-20041	FN-2268	46540-22011	FN-2308
04496-12010	FN-2202	04497-20050	FN-2268	46540-25010	FN-2298
04496-12030	FN-2202	04497-20051	FN-2268	46540-36010	FN-2298
04496-20110	FN-2267	04497-20070	FN-2285	46540-36020	FN-2320
04496-20120	FN-2267	04497-20071	FN-2285	46540-36030	FN-2298
04496-25010	FN-2239	04497-20072	FN-2285	46540-36040	FN-2320
04496-25011	FN-2239	04497-20080	FN-2285	46540-37030	FN-2320
04496-25020	FN-2275	04497-20081	FN-2285	46540-37040	FN-2320

MAZDA-1 Brake Shoe-Cross Reference

Original Parts No.	Mfg. No.	Original Parts No.	Mfg. No.	Original Parts No.	Mfg. No.
0187-33-310	FN-3307	1A04-26-38ZA	FN-9962	A050-26-310	FN-0032
0187-33-310A	FN-3307	1A05-26-310A	FN-9944	A083-26-310	FN-9944
0193-33-310	FN-3307	1A05-26-38Z	FN-9966	A0Y8-26-310	FN-0032
0193-33-310A	FN-3307	1A06-26-38Z	FN-9959	B092-26-310	FN-3356
0433-33-310A	FN-3344	1A06-26-38ZA	FN-9959	B092-26-38Z	FN-3356
0433-33-310B	FN-3324	1A08-26-38Z	FN-5524	B092-49-380	FN-3356
0443-33-310B	FN-3344	1A08-26-38ZA	FN-5524	B216-26-310	FN-3358
04459-60070	FN-2280	1A09-26-38ZA	FN-9958	B216-26-38Z	FN-3358
0448-49-230	FN-3307	1A10-26-38Z	FN-9967	B216-49-380	FN-3358
0483-33-310	FN-3307	1A12-26-38ZA	FN-9928	B2YD-26-38Z	FN-3394
0483-49-230	FN-3307	1A14-26-38Z	FN-9967	B2YD-26-38ZA	FN-3394
0518-33-310	FN-3324	1A14-26-38ZA	FN-9967	B3YH-26-38Z	FN-3427
0559-44-570A	FN-3325	1A14-26-38ZB	FN-9967	B4Y5-26-38Z	FN-3373
0710-26-310	FN-3316	1A17-26-38Z	FN-9973	B4Y5-26-38ZA	FN-3373
0710-33-310	FN-3330	1A50-26-38Z	FN-9947	B4Y5-26-38ZB	FN-3373
0710-33-310A	FN-3330	1A50-26-38ZA	FN-9947	B5Y6-26-38Z	FN-3385
0727-44-560A	FN-8802	1A51-26-38Z	FN-9958	B5Y6-26-38ZA	FN-3385
0820-26-310	FN-3307	1A51-26-38ZA	FN-9958	B5Y7-26-38Z	FN-3385
1011-26-310	FN-3324	1K00-26-310	FN-4465	BC1D-26-310	FN-3385
1011-26-310A	FN-3324	1K00-33-310	FN-4459	BC1D-26-310A	FN-3385
1011-26-38Z	FN-3344	1K00-49-390	FN-4443	BCYD-26-38Z	FN-3385
1312-49-230	FN-3324	1K01-26-310	FN-4451	BCYD-26-38ZA	FN-3385
1312-49-230A	FN-3324	1K01-49-390	FN-4407	BL53-26-38Z	FN-3356
1345-49-230	FN-3330	1K02-26-310	FN-4461	BP18-26-38Z	FN-3358
1345-49-230A	FN-3330	1K02-49-390	FN-4466	BSY6-26-38Z	FN-3373
1353-49-240	FN-4427	1N00-26-38Z	FN-1185	BWYA-26-38Z	FN-3372
1358-26-310	FN-4427	1N01-26-38Z	FN-1170	BWYB-26-38Z	FN-3372
1358-26-310A	FN-4427	1N02-26-38Z	FN-1198	C1Y0-26-38Z	FN-3382
1358-26-330	FN-4427	1N04-26-38Z	FN-1185	C1Y0-26-38ZA	FN-3382
1391-26-310	FN-3328	1N06-26-38Z	FN-1170	C1Y0-26-38ZB	FN-3382
1391-26-310A	FN-3328	2113-26-310	FN-3307	C1Y5-26-38Z	FN-3382
1391-26-330	FN-3328	3514-26-310	FN-3324	D001-26-310	FN-3369
1391-26-330A	FN-3344	3514-26-310A	FN-3324	D001-26-38Z	FN-3369
1391-33-310	FN-3327	3958-26-310	FN-3307	D0Y1-26-38Z	FN-3387
1391-33-310A	FN-3327	3958-26-310A	FN-3307	D101-26-310	FN-3387
1391-33-310B	FN-3327	3958-26-310B	FN-3307	D101-26-310A	FN-3387
1393-49-230	FN-3327	3958-26-38Z	FN-3307	D101-26-310B	FN-3387
1393-49-240	FN-3328	3960-26-310	FN-3307	D102-26-310A	FN-3388
1472-49-230	FN-3327	3960-26-38Z	FN-3307	D102-26-310B	FN-3388
1473-49-230	FN-3327	4111-26-310	FN-3324	D1Y1-26-38Z	FN-3387
1A00-26-310	FN-9943	8124-26-310	FN-3307	D1Y1-26-38ZA	FN-3387
1A00-26-310A	FN-9943	8124-33-310	FN-3307	D1Y1-26-38ZB	FN-3387
1A00-26-38Z	FN-9944	8531-33-310	FN-3307	D1Y2-26-38Z	FN-3388
1A00-33-330	FN-9932	8595-26-310	FN-3324	D1Y2-26-38ZA	FN-3388
1A00-33-330A	FN-9932	A001-26-31X	FN-9931	D1Y2-26-38ZB	FN-3388
1A01-26-310	FN-9919	A001-26-32X	FN-9931	D3Y0-26-38ZA	FN-3421
1A01-26-38Z	FN-9959	A001-26-38Z	FN-9931	DA15-26-38ZA	FN-3369
1A02-26-310	FN-9923	A002-26-38Z	FN-9931	DBY2-26-38Z	FN-3387
1A02-26-38ZA	FN-5524	A011-25-38Z	FN-9928	DX01-26-38Z	FN-3369
1A03-26-310	FN-9952	A011-26-31X	FN-9928	E8BZ-2200-A	FN-3369
1A03-26-38Z	FN-9951	A011-26-32X	FN-9928	ECY1-26-38ZC	FN-3382
1A04-26-310	FN-9951	A011-26-38Z	FN-9928	G00D-26-310	FN-3375
1A04-26-38Z	FN-9962	A012-26-38Z	FN-9928	G00D-26-320	FN-3375

MAZDA-2
Brake Shoe-Cross Reference

Original Parts No.	Mfg. No.	Original Parts No.	Mfg. No.	Original Parts No.	Mfg. No.
GOOD-26-330	FN-3375	LA01-26-330A	FN-3378	S683-26-310	FN-3351
GOOD-26-38Z	FN-3375	LA01-26-330B	FN-3378	S683-26-310A	FN-3351
G030-26-310	FN-3347	LAY1-26-38Z	FN-3378	S6Y0-26-38Z	FN-3348
G030-26-310A	FN-3347	LAY1-26-38ZA	FN-3378	S6Y0-26-38ZA	FN-3348
G030-26-310B	FN-3347	LAY3-26-38ZB	FN-3378	S6Y3-26-38Z	FN-3351
G030-26-38Z	FN-3347	LCY0-26-38Z	FN-3411	S6Y3-26-38ZA	FN-3351
GOY0-26-38Z	FN-3347	LCY0-26-38ZA	FN-3411	SA94-26-310	FN-3349
G1YV-26-38ZA	FN-3399	LCY2-26-38ZB	FN-3402	SA94-26-330	FN-3349
G1YV-26-38ZB	FN-3399	LCY2-26-38ZC	FN-3402	SB40-26-310	FN-3348
G1YV-26-38ZC	FN-3399	LCY2-26-38ZD	FN-3402	SB40-26-330	FN-3348
G1YV-26-38ZD	FN-3382	LDY7-26-38ZB	FN-3411	SB40-49-380	FN-3348
G1YV-26-38ZE	FN-3382	P001-33-310	FN-3330	SE28-26-310	FN-3349
G211-26-38Z	FN-3373	P005-33-37Z	FN-3330	SE28-26-310A	FN-3349
G717-26-310	FN-3375	S01L-26-310	FN-3349	SE28-26-330	FN-3349
G717-26-310A	FN-3375	S02A-26-310	FN-3350	SE28-26-330A	FN-3349
G717-26-320	FN-3375	S02A-26-310A	FN-3350	SE28-26-38Z	FN-3349
G717-26-330	FN-3375	S083-26-310A	FN-3349	SE28-26-38ZA	FN-3349
G717-26-330A	FN-3375	S083-26-310B	FN-3349	SG41-26-310	FN-3349
G717-26-38Z	FN-3375	S083-26-330A	FN-3349	SHY3-26-28Z	FN-3407
G717-26-38ZA	FN-3375	S083-26-330B	FN-3349	U009-26-310A	FN-3378
G717-33-310A	FN-3380	S083-49-380	FN-3349	U0Y5-26-38ZA	FN-3378
G717-33-330	FN-3380	S083-49-380A	FN-3349	U0Y9-26-38Z	FN-3378
G717-33-37Z	FN-3380	S085-26-310	FN-3350	U0Y9-26-38ZA	FN-3378
G717-33-37ZA	FN-3380	S085-26-330	FN-3350	UA01-49-230	FN-3327
GA02-26-310	FN-3344	S085-49-380	FN-3350	UB71-26-310	FN-3378
GAYB-26-38ZC	FN-3386	S0Y8-26-38Z	FN-3426	UB71-26-310A	FN-3378
GAYB-26-38ZD	FN-3386	S0YA-26-38Z	FN-3350	UB71-26-310C	FN-3378
GJ21-26-38Z	FN-3372	S0YL-26-38Z	FN-3349	UB71-26-330	FN-3378
GJ21-26-38ZB	FN-3372	S113-33-310	FN-3355	UB71-26-330A	FN-3378
GJ83-26-38Z	FN-3372	S113-49-370	FN-3355	UB71-26-330C	FN-3378
GJ83-26-38ZA	FN-3372	S113-49-370A	FN-3355	UB71-26-38Z	FN-3378
H029-26-310	FN-3342	S119-33-310	FN-3327	UB71-26-38ZB	FN-3378
H720-26-310A	FN-3365	S119-49-370	FN-3327	UBY2-26-38ZB	FN-3378
H720-26-310B	FN-3365	S119-49-370A	FN-3327	UE02-26-310	FN-3378
H720-26-330B	FN-3365	S121-26-310	FN-3348	UE02-26-330	FN-3378
H720-26-37Z	FN-3364	S121-26-330	FN-3348	UE02-26-38Z	FN-3378
H720-26-38Z	FN-3365	S121-49-380	FN-3348	UGY9-33-23Z	FN-3378
H720-26-38ZA	FN-3365	S126-26-310	FN-3351	V9118-6008	FN-2256
H720-33-37Z	FN-3364	S126-26-330	FN-3351	V9118-6010	FN-2239
H721-33-37Z	FN-3364	S126-49-380	FN-3351	V9118-6012	FN-2263
H722-26-310	FN-3365	S1Y8-26-38Z	FN-3425	W001-33-310	FN-3333
H722-26-330	FN-3365	S24A-26-310A	FN-3348	W001-49-230	FN-3333
H722-26-38Z	FN-3365	S24E-26-310A	FN-3351	W002-49-230	FN-3333
H753-26-310	FN-3374	S2YA-26-38ZA	FN-3348	W015-33-310	FN-3335
H755-26-310	FN-3365	S2YE-26-38ZA	FN-3351	W015-49-230	FN-3335
H755-26-330	FN-3365	S31A-26-310A	FN-3350	W016-49-230	FN-3335
H755-26-38Z	FN-3365	S3YA-26-38ZA	FN-3350	W023-26-310	FN-3334
H7Y1-26-310	FN-3365	S3YF-26-38Z	FN-3349	W023-33-310	FN-3336
H7Y1-26-330	FN-3365	S4YK-26-38ZA	FN-3407	W023-33-310A	FN-3336
H7Y3-26-38Z	FN-3374	S4YP-26-38ZA	FN-3410	W023-44-560	FN-3340
LA01-26-310	FN-3378	S4YS-26-38ZB	FN-3406	W023-44-570	FN-3340
LA01-26-310A	FN-3378	S660-26-310	FN-3348	W023-49-240	FN-3334
LA01-26-330	FN-3378	S660-26-310A	FN-3348	W023-49-312	FN-3334

MAZDA-3 Brake Shoe-Cross Reference

Original Parts No.	Mfg. No.	Original Parts No.	Mfg. No.	Original Parts No.	Mfg. No.
W025-26-310	FN-3337	W420-26-310A	FN-3389		
W025-26-310A	FN-3337	W420-26-38Z	FN-3389		
W029-26-310	FN-3367	W420-26-38ZA	FN-3389		
W029-33-310	FN-3366	W420-33-310	FN-3390		
W029-49-312	FN-3334	W420-33-310A	FN-3390		
W114-26-310	FN-3371	W420-33-310B	FN-3390		
W114-33-310	FN-3370	W420-33-310C	FN-3390		
W114-33-330	FN-3370	W420-33-37Z	FN-3390		
W201-44-560	FN-3384	W420-33-37ZA	FN-3390		
W2Y1-44-39Z	FN-3384	W420-33-37ZB	FN-3390		
W324-26-310	FN-3334	W420-33-37ZC	FN-3390		
W324-26-310A	FN-3334	W530-44-560	FN-3384		
W324-33-310	FN-3333	W531-26-310	FN-3409		
W326-26-310	FN-3337	W558-26-310	FN-3408		
W326-26-310A	FN-3337	W558-33-310A	FN-3408		
W326-26-310B	FN-3337	W5Y1-26-38Z	FN-3409		
W326-26-310C	FN-3337	W5Y8-26-38Z	FN-3408		
W326-26-38Z	FN-3337	W70W-44-560	FN-3340		
W326-26-38ZA	FN-3337	W70W-44-570	FN-3340		
W326-26-38ZB	FN-3337	W76B-26-310	FN-3337		
W326-26-38ZC	FN-3337	W7YB-26-38Z	FN-3337		
W326-33-310	FN-3336	WA97-33-310	FN-3382		
W326-33-310A	FN-3336	WD37-26-310	FN-3362		
W326-33-310B	FN-3336	WD37-33-310	FN-3361		
W326-33-310C	FN-3336	WT96-44-560	FN-8802		
W326-33-37Z	FN-3336	ZZ60-26-38Z	FN-3369		
W326-33-37ZA	FN-3336	ZZS0-26-310	FN-9919		
W326-33-37ZB	FN-3336	ZZS0-26-310A	FN-9919		
W326-33-37ZC	FN-3336	ZZS0-33-330	FN-9932		
W327-33-310	FN-3335	ZZS1-26-310	FN-9919		
W329-26-310	FN-3371	ZZS1-33-330	FN-9932		
W329-33-310	FN-3370	ZZS2-26-310	FN-9943		
W329-33-330	FN-3370	ZZS3-26-310	FN-9943		
W342-26-310	FN-3337	ZZS4-26-310	FN-9919		
W358-26-310A	FN-3362	ZZS4-26-310A	FN-9919		
W358-26-38ZA	FN-3362	ZZSB-26-310	FN-9923		
W358-33-310A	FN-3362	ZZSC-26-310	FN-9923		
W358-33-37ZA	FN-3361	ZZSD-26-310	FN-9919		
W371-26-310B	FN-3383	ZZSE-26-310	FN-9943		
W371-33-310A	FN-3382				
W371-33-37Z	FN-3382				
W391-26-310A	FN-3383				
W391-26-38Z	FN-3383				
W3Y3-44-39Z	FN-3384				
W3Y3-44-39ZA	FN-3384				
W3Y4-26-38Z	FN-3334				
W3Y4-26-38ZA	FN-3334				
W3Y4-26-38ZB	FN-3334				
W3Y4-33-37Z	FN-3333				
W3Y7-33-37Z	FN-3335				
W3Y9-26-38Z	FN-3371				
W3Y9-33-37Z	FN-3370				
W420-26-310	FN-3389				

ISUZU-1

Brake Shoe-Cross Reference

Original Parts No.	Mfg. No.	Original Parts No.	Mfg. No.	Original Parts No.	Mfg. No.
1-46220008	FN-4433	5-87100010	FN-4427	8-94131881	FN-4443
1-46220009	FN-1246	5-87100019	FN-4418	8-94133689	FN-4444
1-46220012	FN-4433	5-87100020	FN-4429	8-94133690	FN-4444
1-46220013	FN-4466	5-87100021	FN-4421	8-94133691	FN-4444
1-46220015	FN-1246	5-87100022	FN-4404	8-94134645	FN-4434
1-46220016	FN-4433	5-87100033	FN-4431	8-94154773	FN-4442
1-46220019	FN-4466	5-87100034	FN-4431	8-94156204	FN-4428
1-46220020	FN-4466	5-87100070	FN-4438	8-94230539	FN-4431
1-46220022	FN-1246	5-87100071	FN-4438	8-94248358	FN-4431
1-46220024	FN-4433	5-87100072	FN-4438	8-94311777	FN-4443
1-46220026	FN-4466	5-87100073	FN-4428	8-94339860	FN-4442
1-46220027	FN-4413	5-87100074	FN-4434	8-94339861	FN-4451
1-46220029	FN-4433	5-87100075	FN-4441	8-94366181	FN-4425
5-46220001	FN-4404	5-87100076	FN-4435	8-94382585	FN-4451
5-47110029	FN-4427	5-87100077	FN-4435	8-94438140	FN-4447
5-47110030	FN-4427	5-87100078	FN-4435	8-94467646	FN-4448
5-47110031	FN-4427	5-87100080	FN-4425	8-94468293	FN-4428
5-47110032	FN-4427	5-87100081	FN-4425	8-94470520	FN-4448
5-47110036	FN-4402	5-87100082	FN-4425	8-94470521	FN-4448
5-47110037	FN-4418	5-87100117	FN-4448	8-94470522	FN-4448
5-47110044	FN-4418	5-87100118	FN-4448	8-94470805	FN-4448
5-47110045	FN-4402	5-87100119	FN-4448	8-94470806	FN-4448
5-47110046	FN-4428	5-87100120	FN-4452	8-94470807	FN-4448
5-47110047	FN-4402	5-87100121	FN-4452	8-94479671	FN-4434
5-47110050	FN-4429	5-87100122	FN-4452	8-94479706	FN-4452
5-47110051	FN-4425	5-87100135	FN-4428	8-94479707	FN-4452
5-47110058	FN-4442	5-87100150	FN-4447	8-94479708	FN-4452
5-47110059	FN-4425	5-87100166	FN-4441	8-97010554	FN-4451
5-47110060	FN-4402	5-87100169	FN-4451	8-97011256	FN-4441
5-47110066	FN-4441	5-87100170	FN-4447	8-97011434	FN-4455
5-47110067	FN-4418	5-87100171	FN-4459	8-97011435	FN-4455
5-47110070	FN-4451	5-87100172	FN-4434	8-97011436	FN-4455
5-86000978	FN-5520	5-87100173	FN-4451	8-97011437	FN-4455
5-86005156	FN-5527	5-87100194	FN-4459	8-97011939	FN-4425
5-86005157	FN-5520	5-87100199	FN-4451	8-97019244	FN-4434
5-86010554	FN-5527	5-87100419	FN-4459	8-97020250	FN-4443
5-86015193	FN-5520	5-87110011	FN-4427	8-97033634	FN-4447
5-86106386	FN-1174	5-88455002	FN-4421	8-97035083	FN-4428
5-86106387	FN-1179	5-88455003	FN-4422	8-97035084	FN-4460
5-86106388	FN-1210	5-88455004	FN-4422	8-97035085	FN-4458
5-86106389	FN-1163	5-88455005	FN-4422	8-97039047	FN-4443
5-86116503	FN-1208	5-88924859	FN-4419	8-97042933	FN-4404
5-86118677	FN-1174	5-88924860	FN-4419	8-97042934	FN-4466
5-86122645	FN-1174	5-87372-447-T	FN-4470	8-97063358	FN-4459
5-86125040	FN-1189	5-87832-448-T	FN-4467	8-97066695	FN-4451
5-86125041	FN-1189	8-49230539	FN-4431	8-97073407	FN-4431
5-86138186	FN-1210	8-94104258	FN-4431	8-97094504	FN-4459
5-87090069	FN-4451	8-94111495	FN-4438	8-97191108	FN-4462
5-87090070	FN-4425	8-94111496	FN-4438	8-97191109	FN-4462
5-87100003	FN-4402	8-94111497	FN-4438	8-97191110	FN-4462
5-87100005	FN-4402	8-94124862	FN-4435	8-97191716	FN-4461
5-87100007	FN-4428	8-94124863	FN-4435	8-97201061	FN-4459
5-87100009	FN-4402	8-94124864	FN-4435	8-97203209	FN-4489

ISUZU-2

Brake Shoe-Cross Reference

Original Parts No.	Mfg. No.	Original Parts No.	Mfg. No.	Original Parts No.	Mfg. No.
8-97217753	FN-4447	96055882	FN-9927		
8-97217754	FN-4451	96058759	FN-9934		
8-97287778	FN-4451	96060651	FN-9933		
8-97331932	FN-4461	96061639	FN-9927		
8-97832-447-T	FN-4470	96063777	FN-9934		
8-97832-448-T	FN-4467	96066915	FN-0032		
9-46200045	FN-4404	96067231	FN-9937		
9-46200601	FN-4404	96067603	FN-9937		
9-46200605	FN-4404	97010554	FN-4451		
9-46230037	FN-4404	97011437	FN-4455		
9-47110382	FN-4402	97020250	FN-4443		
9-47110619	FN-4425				
9-47110624	FN-4419				
9-47110625	FN-4419				
9-47110634	FN-4422				
9-47110645	FN-4421				
9-47110655	FN-4422				
9-47110656	FN-4422				
9-47110657	FN-4422				
9-88424859	FN-4419				
9-88424860	FN-4419				
9-88924833	FN-4402				
9-88924859	FN-4419				
9-88924860	FN-4419				
9-88924861	FN-4404				
46230-037	FN-4404				
47110-655	FN-4421				
91093207	FN-4422				
91118917	FN-4431				
91126277	FN-9923				
91138875	FN-4431				
94020703	FN-4421				
94021482	FN-4422				
94021483	FN-4422				
94021484	FN-4422				
94049962	FN-4451				
94104258	FN-4431				
94124862	FN-4435				
94124863	FN-4435				
94124864	FN-4435				
94154773	FN-4442				
94230539	FN-4431				
94248358	FN-4431				
94314441	FN-4448				
94339859	FN-4448				
94339860	FN-4442				
94366181	FN-4425				
94470805	FN-4448				
94470806	FN-4448				
94470807	FN-4448				
96052361	FN-9914				
96053329	FN-9914				
96055024	FN-9927				

HONDA-1

Brake Shoe-Cross Reference

Original Parts No.	Mfg. No.	Original Parts No.	Mfg. No.	Original Parts No.	Mfg. No.
01431-SAA-000	FN-5534	43153-SB2-602	FN-5518	43153-SV4-J01	FN-5520
01431-SAE-T01	FN-5534	43153-SB2-603	FN-5518	43154-623-670	FN-5504
01432-SAA-000	FN-5534	43153-SB6-003	FN-5519	43154-679-013	FN-5504
01432-SAE-T01	FN-5534	43153-SB6-671	FN-5519	43154-692-003	FN-5510
06043-634-670	FN-5504	43153-SC2-002	FN-5517	43154-S10-A01	FN-5524
06043-671-000	FN-5504	43153-SC2-003	FN-5517	43154-S6A-J01	FN-5524
064B3-671-000	FN-5504	43153-SC2-013	FN-5517	43154-SA0-003	FN-5510
064B3-SA5-670	FN-5516	43153-SD5-000	FN-5521	43154-SA0-013	FN-5510
43053-SM4-A00	FN-5524	43153-SD5-003	FN-5521	43154-SA0-023	FN-5510
43151-679-003	FN-5509	43153-SD5-013	FN-5521	43154-SA0-033	FN-5510
43152-601-004	FN-5504	43153-SD5-023	FN-5521	43154-SA0-671	FN-5510
43152-601-006	FN-5504	43153-SD9-003	FN-5519	43154-SA0-672	FN-5510
43153-601-004	FN-5504	43153-SD9-671	FN-5519	43154-SA0-901	FN-5510
43153-601-006	FN-5504	43153-SD9-672	FN-5519	43154-SA0-N51	FN-5510
43153-623-670	FN-5504	43153-SE0-003	FN-5520	43154-SA2-003	FN-5512
43153-671-003	FN-5504	43153-SE0-013	FN-5520	43154-SAA-004	FN-5534
43153-671-N51	FN-5504	43153-SE0-S01	FN-5520	43154-SAE-T02	FN-5534
43153-679-003	FN-5504	43153-SF4-013	FN-5521	43154-SJ6-003	FN-5522
43153-679-013	FN-5504	43153-SF4-505	FN-5521	43154-SJ6-505	FN-5522
43153-679-601	FN-5504	43153-SFA-003	FN-5541	43154-SM4-A01	FN-5524
43153-692-003	FN-5510	43153-SH0-A01	FN-5527	43155-S10-A01	FN-5524
43153-S04-003	FN-5527	43153-SH3-003	FN-5527	43155-S6A-J01	FN-5524
43153-S10-A01	FN-5524	43153-SH3-013	FN-5527	43155-SAA-004	FN-5534
43153-S1F-004	FN-0030	43153-SH3-023	FN-5527	43155-SAE-T02	FN-5534
43153-S2G-951	FN-5520	43153-SH3-517	FN-5527	43155-SM4-A01	FN-5524
43153-S2H-003	FN-5520	43153-SH3-A01	FN-5518	43156-567-000	FN-5504
43153-S2K-004	FN-5529	43153-SH3-A02	FN-5518	43157-567-000	FN-5504
43153-S3A-004	FN-5520	43153-SH3-G02	FN-5518	43516-567-000	FN-5504
43153-S50-003	FN-5528	43153-SH5-003	FN-5519	45151-679-003	FN-5509
43153-S5A-A01	FN-5520	43153-SH5-013	FN-5519	45151-679-013	FN-5509
43153-S5A-J01	FN-5520	43153-SH5-A01	FN-5519	GBS-807	FN-5510
43153-S6A-J01	FN-5524	43153-SH5-A02	FN-5519	GBS-90807	FN-5510
43153-SA0-003	FN-5510	43153-SH5-G01	FN-5519	GBS-90821	FN-5518
43153-SA0-013	FN-5510	43153-SJ6-003	FN-5522	GBS-90829	FN-5518
43153-SA0-023	FN-5510	43153-SJ6-013	FN-5522		
43153-SA0-671	FN-5510	43153-SJ6-023	FN-5520		
43153-SA0-672	FN-5510	43153-SJ6-505	FN-5522		
43153-SA0-901	FN-5510	43153-SK7-003	FN-5519		
43153-SA2-003	FN-5512	43153-SK7-013	FN-5519		
43153-SA5-003	FN-5516	43153-SK7-505	FN-5519		
43153-SA5-013	FN-5516	43153-SM4-003	FN-5520		
43153-SA5-671	FN-5516	43153-SM4-A01	FN-5524		
43153-SA5-672	FN-5516	43153-SN4-003	FN-5519		
43153-SA5-673	FN-5516	43153-SNA-A01	FN-5547		
43153-SA6-003	FN-5516	43153-SR3-003	FN-5527		
43153-SA6-305	FN-5516	43153-SR3-902	FN-5527		
43153-SA6-671	FN-5516	43153-SR3-A01	FN-5527		
43153-SA6-672	FN-5516	43153-SR4-A02	FN-5520		
43153-SA6-673	FN-5516	43153-SR7-003	FN-5520		
43153-SAA-004	FN-5534	43153-ST0-901	FN-5527		
43153-SAE-T02	FN-5534	43153-ST0-J01	FN-5520		
43153-SB2-003	FN-5527	43153-ST5-014	FN-0030		
43153-SB2-601	FN-5518	43153-SV4-505	FN-5520		

MITSUBISHI-1 Brake Shoe-Cross Reference

Original Parts No.	Mfg. No.	Original Parts No.	Mfg. No.	Original Parts No.	Mfg. No.
107334	FN-6600	MB151244	FN-6646	MB295104	FN-6667
4422003030	FN-6680	MB151244Y	FN-6646	MB295105	FN-6602
4422003031	FN-6680	MB16142	FN-6655	MB295106	FN-6667
4422003032	FN-6680	MB162045	FN-6653	MB295106Y	FN-6667
4600A150	FN-6726	MB162110	FN-6656	MB295107	FN-6668
4800A008	FN-6729	MB162110Y	FN-6656	MB295107Y	FN-6602
A122892	FN-6605	MB162111	FN-6656	MB295157	FN-6668
A122893	FN-6605	MB162111Y	FN-6656	MB295178	FN-6653
A305042	FN-6616	MB162142	FN-6655	MB295179	FN-6653
A305095	FN-6617	MB162142Y	FN-6655	MB295387	FN-6667
DRC502002	FN-6664	MB162160	FN-6654	MB295387K	FN-6667
MA125756	FN-6605	MB162160Y	FN-6654	MB295388	FN-6602
MA161872	FN-6609	MB162367	FN-6627	MB295388K	FN-6668
MA180733	FN-6626	MB162367Y	FN-6627	MB295391	FN-6667
MA305042	FN-6616	MB162368	FN-6602	MB295392	FN-6602
MA305095	FN-6617	MB162368Y	FN-6602	MB295768	FN-6667
MB004062	FN-6626	MB162369	FN-6667	MB295769	FN-6668
MB004063	FN-6609	MB162369K	FN-6667	MB316608	FN-6618A
MB044732	FN-6618A	MB162369Y	FN-6627	MB316609	FN-6618A
MB044733	FN-6618A	MB162370	FN-6602	MB326388	FN-6602
MB058847	FN-6618A	MB162370K	FN-6668	MB334302	FN-6653
MB058848	FN-6618A	MB162370Y	FN-6602	MB366143	FN-6669
MB060101	FN-6667	MB162427	FN-6653	MB366169	FN-6636
MB060101Y	FN-6627	MB162521	FN-6653	MB366320	FN-6609
MB060102	FN-6602	MB162665	FN-6653	MB366330	FN-6670
MB060102Y	FN-6602	MB193136	FN-6657	MB366331	FN-6670
MB060205	FN-6627	MB193137	FN-6657	MB366332	FN-6670
MB060206	FN-6602	MB193139	FN-6657	MB366333	FN-6670
MB060206Y	FN-6602	MB193506	FN-6626	MB366443	FN-6674
MB060220	FN-6627	MB238107	FN-6646	MB366444	FN-6674
MB060221	FN-6602	MB238114	FN-6664	MB366445	FN-6674
MB060235	FN-6627	MB238363	FN-6633	MB366446	FN-6674
MB060235Y	FN-6627	MB238364	FN-6633	MB407250	FN-6609
MB060236	FN-6602	MB238365	FN-6633	MB407842	FN-6687
MB060236Y	FN-6602	MB238383	FN-6637	MB407843	FN-6687
MB060237	FN-6627	MB238384	FN-6637	MB407844	FN-6687
MB060237Y	FN-6602	MB238385	FN-6637	MB500202	FN-6685
MB060238	FN-6602	MB238520	FN-6664	MB500822	FN-6686
MB060238Y	FN-6602	MB238521	FN-6664	MB500922	FN-6678
MB060269	FN-6602	MB238522	FN-6664	MB500923	FN-6678
MB060596	FN-6653	MB238523	FN-6664	MB534398	—
MB060596Y	FN-6653	MB277006	FN-6660	MB534594	FN-6674
MB082220	FN-6633	MB277007	FN-6660	MB534595	FN-6674
MB082221	FN-6633	MB277008	FN-6660	MB534596	FN-6674
MB082222	FN-6633	MB277009	FN-6660	MB534597	FN-6674
MB134832	FN-6636	MB277474	FN-6678	MB534656	FN-6669
MB139917	FN-6646	MB277475	FN-6678	MB534875	FN-6704
MB150655	FN-6633	MB277786	FN-6678	MB534876	FN-6704
MB150656	FN-6633	MB277787	FN-6678	MB534877	FN-6704
MB150657	FN-6633	MB295096	FN-6667	MB587168	FN-6685
MB151059	FN-6637	MB295096Y	FN-6667	MB587174	FN-6636
MB151060	FN-6637	MB295097	FN-6602	MB587658	FN-6686
MB151061	FN-6637	MB295097Y	FN-6602	MB587659	FN-6664

MITSUBISHI-2 Brake Shoe-Cross Reference

Original Parts No.	Mfg. No.	Original Parts No.	Mfg. No.	Original Parts No.	Mfg. No.
MB587660	FN-6664	MB699772	FN-6707	ME624781	FN-6680
MB587661	FN-6664	MB699773	FN-6707	ME625031	FN-6680
MB587727	FN-6687	MB858665	FN-6712	ME625037	FN-6680
MB587728	FN-6687	MB858666	FN-6674	ME640244	FN-6680
MB587729	FN-6687	MB858667	FN-6674	MK355886	FN-4447
MB618084	FN-6678	MB858668	FN-6674	MK501035	FN-4466
MB618085	FN-6678	MB858669	FN-6674	MK585826	FN-6722
MB618189	FN-6701	MB858684	FN-6712	MN116756	FN-6729
MB618190	FN-6701	MB858685	FN-6712	MN116757	FN-6729
MB618191	FN-6701	MB858686	FN-6712	MN116758	FN-6729
MB618192	FN-6701	MB858876	FN-6715	MQ703667	FN-1264
MB618193	FN-6701	MB858877	FN-6715	MQ907149	FN-3407
MB618194	FN-6701	MB858878	FN-6715	MQ907151	FN-3410
MB618403	FN-6670	MB858926	FN-6704	MQ907155	FN-3406
MB668335	FN-6701	MB858927	FN-6704	MQ907419	FN-3407
MB668336	FN-6687	MB858928	FN-6704	MQ907420	FN-3410
MB668337	FN-6687	MB895154	FN-6637	MQ907421	FN-3406
MB668338	FN-6687	MB895212	FN-6633	MQ911378	FN-3426
MB668460	FN-6707	MB895213	FN-6633	MQ911392	FN-3425
MB668461	FN-6707	MB895214	FN-6633	MR124712	FN-6707
MB668462	FN-6707	MB895258	FN-6721	MR129850	FN-6704
MB668463	FN-6707	MB895475	FN-6718	MR129851	FN-6704
MB668466	FN-6707	MB895476	FN-6718	MR129852	FN-6704
MB668467	FN-6707	MB895477	FN-6718	MR178823	FN-6715
MB668670	FN-6710	MB895986	FN-6707	MR178824	FN-6721
MB668671	FN-6710	MB895987	FN-6707	MR178825	FN-6686
MB668740	FN-6712	MB895988	FN-6707	MR178826	FN-6718
MB668741	FN-6712	MB928991	FN-6670	MR179542	FN-6637
MB668742	FN-6712	MB928992	FN-6670	MR249576	FN-6723
MB668745	FN-6712	MB950064	FN-6701	MR249577	FN-6723
MB668746	FN-6712	MB950065	FN-6687	MR249585	FN-6726
MB668776	FN-6710	MC112216	FN-6667	MR249586	FN-6726
MB668777	FN-6710	MC112217	FN-6602	MR249587	FN-6726
MB668790	FN-6707	MC112258	FN-6653	MR289625	FN-6723
MB668791	FN-6707	MC112501	FN-6600	MR376699	FN-6723
MB668792	FN-6707	MC828893	FN-4413	MR449086	FN-6729
MB668793	FN-6707	MC837547	FN-6602	MR449087	FN-6729
MB668794	FN-6707	MC837547Y	FN-6602	MR449088	FN-6729
MB668795	FN-6707	MC837658	FN-6680	MR449682	FN-6723
MB699017	FN-6664	MC837950	FN-6600	MR449683	FN-6723
MB699018	FN-6664	MC865115	FN-6653	MR449684	FN-6723
MB699019	FN-6664	MC865985	FN-6656	MR465091	FN-6726
MB699079	FN-6686	MC869379	FN-6681	MR476000	FN-6723
MB699104	FN-6618A	MC894239	FN-6653	MR485499	FN-6729
MB699105	FN-6618A	MC894263	FN-4443	MR485638	FN-6704
MB699116	FN-6637	MC894462	FN-6656	MR569372	FN-6729
MB699117	FN-6637	MC894575	FN-6653	MR569373	FN-6729
MB699334	FN-6701	MC894596	FN-6655	MR569374	FN-6729
MB699335	FN-6701	MC894606	FN-6602	MR586855	FN-6729
MB699336	FN-6701	MC894610	FN-6653	MR954979	FN-6707
MB699765	FN-6670	MC895728	FN-3366	MST05040	FN-6605
MB699766	FN-6707	ME601284	FN-6681	MST05044	FN-6626
MB699771	FN-6707	ME624581	FN-6680	MST05045	FN-6609

MITSUBISHI-3 Brake Shoe-Cross Reference

Original Parts No.	Mfg. No.	Original Parts No.	Mfg. No.	Original Parts No.	Mfg. No.
MT107334	FN-6600	NT0016	FN-6616		
MT141460	FN-6618A	NT0017	FN-6617		
MT141461	FN-6618A				
MT161474	FN-6600				
MT326386	FN-6602				
MT326388	FN-6602				
MUT05014	FN-6618A				
MUT05015	FN-6627				
MUT05016	FN-6602				
MUT05017	FN-6627				
MUT05018	FN-6602				
MUT05019	FN-6627				
MUT05041	FN-6667				
MUT05042	FN-6602				
MZ091188	FN-6678				
MZ981017	FN-6633				
MZ981057	FN-6654				
MZ981095	FN-6656				
MZ981096	FN-6655				
MZ981097	FN-6627				
MZ981098	FN-6627				
MZ981099	FN-6602				
MZ981100	FN-6602				
MZ981124	FN-6649				
MZ981130	FN-6646				
MZ981131	FN-6646				
MZ981132	FN-6618A				
MZ981134	FN-6637				
MZ981135	FN-6660				
MZ981138	FN-6600				
MZ981148	FN-6633				
MZ981150	FN-6626				
MZ981163	FN-6667				
MZ981164	FN-6668				
MZ981173	FN-6667				
MZ981174	FN-6667				
MZ981175	FN-6668				
MZ981176	FN-6668				
MZ981178	FN-6657				
MZ981179	FN-6664				
MZ981180	FN-6664				
MZ981181	FN-6660				
MZ981182	FN-6669				
MZ981183	FN-6670				
MZ981184	FN-6674				
MZ981185	FN-6660				
MZ981186	FN-6667				
MZ981187	FN-6668				
MZ981189	FN-6678				
MZ981191	FN-6609				
MZ981192	FN-6636				
MZ981193	FN-6685				
MZ981195	FN-6678				

SUBARU-1 Brake Shoe-Cross Reference

Original Parts No.	Mfg. No.	Original Parts No.	Mfg. No.	Original Parts No.	Mfg. No.
625300351	FN-7720	25178GA300	FN-7729		
625300352	FN-7720	25178GA310	FN-7730		
625300354	FN-7720	25178GA311	FN-7730		
625300355	FN-7720	25178GA390	FN-7730		
625300361	FN-7720	25178GA400	FN-7729		
625300362	FN-7720	26214KA010	FN-7731		
625300364	FN-7720	26214KA020	FN-7731		
625300365	FN-7720	26214KA030	FN-7731		
625301260	FN-7713	26214KA060	FN-7731		
625301261	FN-7713	26214KA070	FN-7731		
725178040	FN-7722	26214KA080	FN-7731		
725178110	FN-7720	26214TA010	FN-7750		
725178111	FN-7720	26214TA020	FN-7750		
725178120	FN-7720	26214TA030	FN-7750		
725178121	FN-7720	26257AA000	FN-7744		
725178130	FN-7723	26257AA010	FN-7744		
725178140	FN-7734	26257AA020	FN-7744		
725178141	FN-7734	26257AA030	FN-7747		
725178150	FN-7734	26257AA040	FN-7747		
725178151	FN-7734	26257AA050	FN-7747		
725178160	FN-7734	26290KA080	FN-7731		
725178161	FN-7734	26290KA090	FN-7731		
725178170	FN-7728	26290KA100	FN-7731		
725178230	FN-7720	26290KA130	FN-7731		
725178231	FN-7720	26290KA140	FN-7731		
725178240	FN-7720	26290KA180	FN-7731		
725178241	FN-7720	26290TA050	FN-7743		
725178290	FN-7723	26290TA060	FN-7750		
725178291	FN-7723	26290TA080	FN-7750		
725178292	FN-7723	26298AA000	FN-7744		
725178320	FN-7720	26298AA010	FN-7747		
725178321	FN-7720	26298AA011	FN-7747		
725178322	FN-7720	26298AA040	FN-7747		
725178330	FN-7720	26614KC020	FN-7731		
725178331	FN-7720	26690KC000	FN-7731		
725178332	FN-7720	26690KC010	FN-7731		
725178360	FN-7728	26690KC020	FN-7731		
725178370	FN-7737	26694AE000	FN-7753		
725178380	FN-7737	26694AE001	FN-7753		
725178450	FN-7734	26694KE000	FN-7731		
725178460	FN-7734	26694KE020	FN-7731		
725178470	FN-7734	26694TC000	FN-9952		
725178480	FN-7728				
725178481	FN-7728				
725178490	FN-7734				
725178500	FN-7734				
725178510	FN-7734				
725178520	FN-7743				
725178530	FN-7743				
725178540	FN-7743				
725193180	FN-7734				
25178GA100	FN-7729				
25178GA180	FN-7730				

SUZUKI-1 Brake Shoe-Cross Reference

Original Parts No.	Mfg. No.	Original Parts No.	Mfg. No.	Original Parts No.	Mfg. No.
52200-77800	FN-9910	52210-85000	FN-9918	53200-69G10	FN-0032
52200-80810	FN-9932	52210-85002	FN-9918	53200-69G11	FN-0032
52200-80811	FN-9932	52210-85010	FN-9918	53200-69G12	FN-0032
52200-80820	FN-9918	52210-85020	FN-9918	53200-70800	FN-9921
52200-80821	FN-9918	52210-85030	FN-9932	53200-70820	FN-9944
52200-80830	FN-9910	52210-85040	FN-9932	53200-70821	FN-9944
52200-84800	FN-9915	52210-85050	FN-9918	53200-70822	FN-9944
52200-84801	FN-9915	52210-85400	FN-9910	53200-70840	FN-9944
52201-78010	FN-9905	53200-50801	FN-9943	53200-75F11	FN-9944
52201-78011	FN-9905	53200-50810	FN-0032	53200-76G00	FN-9959
52201-78012	FN-9905	53200-50820	FN-9952	53200-76G20	FN-9959
52201-78013	FN-9905	53200-51800	FN-9919	53200-76G31	FN-9959
52201-78014	FN-9905	53200-51810	FN-9951	53200-76G51	FN-9959
52201-78015	FN-9905	53200-52D00	FN-9958	53200-76J00	FN-5524
52201-78020	FN-9905	53200-52D20	FN-9968	53200-77810	FN-9947
52201-78022	FN-9905	53200-52D21	FN-9968	53200-77811	FN-9947
52201-84010	FN-9915	53200-56810	FN-9942	53200-77E11	FN-9947
52201-84011	FN-9915	53200-56820	FN-9942	53200-78810	FN-9907
52201-84012	FN-9915	53200-56821	FN-9942	53200-78A00	FN-9951
52202-78010	FN-9905	53200-58J00	FN-9967	53200-79A00	FN-9962
52202-78011	FN-9905	53200-58J10	FN-9967	53200-79A01	FN-9962
52202-78012	FN-9905	53200-58J11	FN-9967	53200-80810	FN-9913
52202-78013	FN-9905	53200-58J12	FN-9967	53200-80840	FN-9917
52202-78014	FN-9905	53200-60810	FN-9934	53200-80870	FN-9923
52202-78015	FN-9905	53200-60811	FN-9934	53200-81A00	FN-5524
52202-78020	FN-9905	53200-60812	FN-9934	53200-81A01	FN-5524
52202-78022	FN-9905	53200-60820	FN-9933	53200-81A11	FN-5524
52202-81020	FN-9915	53200-60821	FN-9933	53200-82810	FN-9914
52202-84010	FN-9915	53200-60830	FN-9921	53200-86800	FN-9927
52202-84011	FN-9915	53200-60840	FN-0032	53200-86810	FN-9927
52202-84012	FN-9915	53200-60841	FN-0032	53200-86820	FN-9927
52202-84020	FN-9915	53200-60850	FN-9937	53201-70A00	FN-9921
52210-52010	FN-9909	53200-60851	FN-9937	53201-70A10	FN-9921
52210-58040	FN-9902	53200-60860	FN-9937	53201-83300	FN-9921
52210-60010	FN-9902	53200-60861	FN-9937	53201-83310	FN-9921
52210-60020	FN-9902	53200-60871	FN-9921	53202-70A00	FN-9921
52210-73040	FN-9909	53200-60880	FN-9955	53202-70A10	FN-9921
52210-73041	FN-9909	53200-60A51	FN-9955	53202-83300	FN-9921
52210-73140	FN-9909	53200-60B11	FN-9933	53202-83310	FN-9921
52210-75140	FN-9902	53200-62J02	FN-2386	53210-50A10	FN-7728
52210-77300	FN-9910	53200-63J00	FN-9969	53210-50E00	FN-9931
52210-77301	FN-9910	53200-63J01	FN-9969	53210-50E10	FN-0032
52210-79020	FN-9904	53200-63J02	FN-9969	53210-50E60	FN-9928
52210-79021	FN-9904	53200-65D00	FN-9958	53210-50F00	FN-9943
52210-79022	FN-9904	53200-65D01	FN-9958	53210-50F10	FN-9943
52210-79023	FN-9904	53200-65D10	FN-9958	53210-50F50	FN-9943
52210-79030	FN-9904	53200-65D11	FN-9958	53210-51F50	FN-9919
52210-79240	FN-9910	53200-65J00	FN-9970	53210-52A10	FN-9920
52210-79241	FN-9910	53200-65J01	FN-9970	53210-56A50	FN-7728
52210-79260	FN-9910	53200-67H00	FN-9966	53210-60A00	FN-9934
52210-80040	FN-9910	53200-68H00	FN-9973	53210-60A10	FN-9934
52210-84012	FN-9915	53200-68H10	FN-9973	53210-60A20	FN-9934
52210-84020	FN-9915	53200-69G00	FN-0032	53210-60A30	FN-9937

SUZUKI-2 Brake Shoe-Cross Reference

Original Parts No.	Mfg. No.	Original Parts No.	Mfg. No.	Original Parts No.	Mfg. No.
53210-60A70	FN-9937				
53210-60A71	FN-9937				
53210-60B00	FN-9933				
53210-60B10	FN-9933				
53210-70C00	FN-0032				
53210-70C10	FN-0032				
53210-70D00	FN-9919				
53210-78010	FN-9907				
53210-78040	FN-9907				
53210-78410	FN-9907				
53210-78470	FN-9907				
53210-80050	FN-9913				
53210-82030	FN-9914				
53210-82031	FN-9914				
53210-83040	FN-9917				
53210-83041	FN-9917				
53210-84010	FN-7728				
53210-84210	FN-9920				
53210-85010	FN-9919				
53210-85011	FN-9919				
53210-85020	FN-9919				
53210-85040	FN-9919				
53210-85120	FN-9919				
53210-85200	FN-9923				
53210-85201	FN-9923				
53210-85250	FN-9923				
53210-86000	FN-9927				
53210-86040	FN-9927				
53220-50E00	FN-9931				
53220-50E60	FN-9928				
53230-50E00	FN-9931				
53230-50E60	FN-9928				
53800-50800	FN-7728				
53800-52800	FN-9940				
53800-52801	FN-9940				
53800-56810	FN-7728				
53800-60800	FN-9931				
53800-62800	FN-9928				
53800-70800	FN-9931				
53800-70810	FN-9928				
53800-70811	FN-9928				
53820-52A10	FN-9940				
53820-70B00	FN-9931				
53820-70B60	FN-9928				
53830-50A10	FN-9938				
53830-52A10	FN-9940				
53830-70B00	FN-9931				
53830-70B60	FN-9928				
54710-73040	FN-9902				
54710-73070	FN-9902				

DAIHATSU-1 Brake Shoe-Cross Reference

Original Parts No.	Mfg. No.	Original Parts No.	Mfg. No.	Original Parts No.	Mfg. No.
04494-10030-000	FN-2237A	04495-87208-000	FN-0025	04496-10010-000	FN-2237A
04494-12040-000	FN-2202	04495-87209-000	FN-0027	04496-12030-000	FN-2202
04494-20020-000	FN-2210	04495-87210-000	FN-0024	04496-20020-000	FN-2210
04494-20090-000	FN-2238	04495-87214-000	FN-0027	04496-20091-000	FN-2238
04494-20091-000	FN-2238	04495-87215-000	FN-0024	04496-20110-000	FN-2267
04494-20110-000	FN-2267	04495-87216-000	FN-0025	04496-28010-000	FN-2238
04494-20130-000	FN-2267	04495-87217-000	FN-0029	04496-28020-000	FN-2267
04494-27010-000	FN-2238	04495-87401-000	FN-2333	04496-87307-000	FN-0016
04494-28010-000	FN-2238	04495-87402-000	FN-2339	04496-87309-000	FN-4428
04494-28020-000	FN-2267	04495-87502-000	FN-0009	04497-10030-000	FN-2254
04494-36150-000	FN-2297	04495-87503-000	FN-0009	04497-12010-000	FN-2203
04494-36160-000	FN-2296	04495-87504-000	FN-0009	04497-12030-000	FN-2203
04494-36190-000	FN-2329	04495-87601-000	FN-0022	04497-12040-000	FN-2203
04494-36210-000	FN-2329	04495-87603-000	FN-0022	04497-12050-000	FN-2232
04494-36280-000	FN-2296	04495-87605-000	FN-0022	04497-14020-000	FN-2232
04494-36290-000	FN-2329	04495-87608-000	FN-2317A	04497-20030-000	FN-2232
04494-87201-000	FN-0026	04495-87701-000	FN-0009	04497-20060-000	FN-2232
04494-87202-000	FN-0026	04495-87702-000	FN-0020	46530-25010-000	FN-0015
04494-87203-000	FN-0026	04495-87705-000	FN-0030	46530-36010-000	FN-0015
04494-87307-000	FN-0016	04495-87707-000	FN-0032	46530-36020-000	FN-0019
04494-87308-000	FN-2239	04495-87708-000	FN-0032	46530-37030-000	FN-0015
04494-87309-000	FN-4428	04495-87710-000	FN-0030	46530-87301-000	FN-0015
04494-87310-000	FN-0016	04495-87712-000	FN-0034	46530-87303-000	FN-0015
04494-87314-000	FN-2239	04495-87713-000	FN-0032	46530-87304-000	FN-0039
04494-87315-000	FN-0016	04495-87714-000	FN-0035	46530-87305-000	FN-0015
04494-87316-000	FN-4428	04495-97201-000	FN-0036	46530-87306-000	FN-0015
04494-87701-000	FN-2202	04495-97202-000	FN-0020	46530-87307-000	FN-0039
04495-10010-000	FN-2237B	04495-97203-000	FN-0036	46530-87308-000	FN-0039
04495-10030-000	FN-2254	04495-97204-000	FN-0036	46530-87601-000	FN-0015
04495-12010-000	FN-2203	04495-97205-000	FN-0024	46540-25010-000	FN-2298
04495-12050-000	FN-2203	04495-97206-000	FN-0037	46540-36030-000	FN-2298
04495-12060-000	FN-2203	04495-97207-000	FN-0040	46540-36040-000	FN-2320
04495-12070-000	FN-2232	04495-97208-000	FN-0037	46540-37030-000	FN-2320
04495-14020-000	FN-2232	04495-97209-000	FN-0027	46550-25010-000	FN-2298
04495-20050-000	FN-2232	04495-97210-000	FN-0042	46550-36030-000	FN-2298
04495-20080-000	FN-2232	04495-97211-000	FN-0030	46550-36040-000	FN-2320
04495-22081-000	FN-2232	04495-97217-000	FN-0030	46550-37030-000	FN-2320
04495-22090-000	FN-2232	04495-97218-000	FN-0042	47410-10012-000	FN-2237A
04495-26091-000	FN-2282A	04495-97219-000	FN-0027	47410-10020-000	FN-2237A
04495-27041-000	FN-2232	04495-97501-000	FN-0041	47410-20022-000	FN-2210
04495-28061-000	FN-2252	04495-B1010-000	FN-0042	47410-20110-000	FN-2238
04495-28100-000	FN-2339	04495-B1020-000	FN-0042	47410-87201-000	FN-0008
04495-28111-000	FN-2335A	04495-B1050-000	FN-0041	47410-87202-000	FN-0008
04495-28120-000	FN-2335A	04495-B1080-000	FN-0042	47410-87203-000	FN-0008
04495-28160-000	FN-2339	04495-B2010-000	FN-0027	47410-87204-000	FN-0008
04495-37040-000	FN-2329	04495-B2070-000	FN-0024	47410-87205-000	FN-0026
04495-44010-000	FN-2339	04495-B2080-000	FN-0037	47410-87310-000	FN-0016
04495-44020-000	FN-2339	04495-B2100-000	FN-0040	47410-87501-000	FN-0008
04495-87201-000	FN-0009	04495-B2130-000	FN-0042	47410-87502-000	FN-0008
04495-87203-000	FN-0027	04495-B2140-000	FN-0030	47410-87503-000	FN-0008
04495-87204-000	FN-0024	04495-B2160-000	FN-0042	47410-87504-000	FN-0008
04495-87206-000	FN-0025	04495-B2170-000	FN-0027	47410-87505-000	FN-2202
04495-87207-000	FN-0027	04495-B4010-000	FN-2339	47410-87508-000	FN-2202

DAIHATSU-2 Brake Shoe-Cross Reference

Original Parts No.	Mfg. No.	Original Parts No.	Mfg. No.	Original Parts No.	Mfg. No.
47410-87512-000	FN-0026	47430-B2031-000	FN-0030		
47410-87702-000	FN-0020	47430-B2050-000	FN-0027		
47410-87801-000	FN-0026	47430-B2051-000	FN-0027		
47420-10012-000	FN-2237A	47440-20011-000	FN-2210		
47420-10020-000	FN-2237A	47440-87201-000	FN-0009		
47420-87303-000	FN-4428	47440-87204-000	FN-0009		
47420-87501-000	FN-0029	47440-87501-000	FN-0009		
47420-87502-000	FN-0028	47440-87502-000	FN-0009		
47420-87503-000	FN-0029	47440-87503-000	FN-0009		
47420-87504-000	FN-0028	47440-87504-000	FN-0009		
47420-87505-000	FN-0029	0449E-87307	FN-0016		
47420-87506-000	FN-0028	0449E-87309	FN-4428		
47420-87511-000	FN-0035	0449E-87310	FN-0016		
47420-87512-000	FN-0029	0449G-87307	FN-0016		
47420-87513-000	FN-0028	0449G-87309	FN-4428		
47420-97201-000	FN-0036	4653A-87301	FN-0015		
47420-97202-000	FN-0036	4653A-87303	FN-0015		
47420-97203-000	FN-0037	4653A-87305	FN-0015		
47420-97204-000	FN-0036	SU002-00286	FN-4443		
47420-97501-000	FN-0035	SU002-00693	FN-4466		
47420-B2010-000	FN-0042				
47430-20011-000	FN-2210				
47430-87201-000	FN-0009				
47430-87204-000	FN-0009				
47430-87205-000	FN-0021				
47430-87214-000	FN-0024				
47430-87219-000	FN-0024				
47430-87220-000	FN-0027				
47430-87221-000	FN-0025				
47430-87501-000	FN-0009				
47430-87502-000	FN-0009				
47430-87503-000	FN-0009				
47430-87504-000	FN-0009				
47430-87505-000	FN-0021				
47430-87506-000	FN-0029				
47430-87507-000	FN-0029				
47430-87508-000	FN-0029				
47430-87513-000	FN-0035				
47430-87514-000	FN-0029				
47430-97201-000	FN-0036				
47430-97202-000	FN-0020				
47430-97203-000	FN-0036				
47430-97204-000	FN-0037				
47430-97205-000	FN-0036				
47430-97206-000	FN-0040				
47430-97501-000	FN-0035				
47430-97502-000	FN-0035				
47430-97503-000	FN-0038				
47430-B2010-000	FN-0027				
47430-B2020-000	FN-0042				
47430-B2021-000	FN-0042				
47430-B2023-000	FN-0042				
47430-B2030-000	FN-0030				

DISC BRAKE PADS

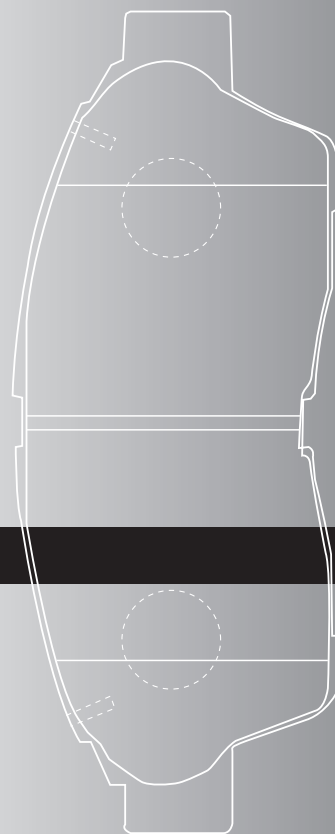

CROSS REFERENCE

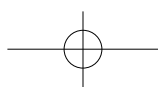
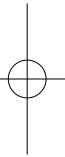
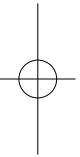
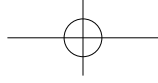
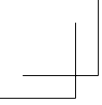

TOYOTA-1 Brake Pad-Cross Reference

Genuine Parts No.	JFBK Parts No.	Genuine Parts No.	JFBK Parts No.	Genuine Parts No.	JFBK Parts No.
04465-02070	HN-470	04465-20040	HN-281	04465-26301	HN-237
04465-02080	HN-470	04465-20060	HN-077C	04465-26320	HN-237
04465-02220	HN-524	04465-20080	HN-077C	04465-26370	HN-237
04465-06020	HN-228	04465-20090	HN-281	04465-26420	HN-516
04465-10011	HN-134	04465-20100	HN-360	04465-27010	HN-216
04465-10020	HN-256	04465-20110	HN-322	04465-27040	HN-217
04465-10040	HN-077C	04465-20130	HN-322	04465-27080	HN-217
04465-10070	HN-256	04465-20140	HN-322	04465-27120	HN-503
04465-10090	HN-134	04465-20210	HN-281	04465-28010	HN-216
04465-10160	HN-134	04465-20230	HN-362	04465-28020	HN-216
04465-12010	HN-077C	04465-20250	HN-362	04465-28030	HN-273
04465-12060	HN-067	04465-20290	HN-192	04465-28050	HN-218
04465-12090	HN-077C	04465-20310	HN-281	04465-28080	HN-273
04465-12110	HN-322	04465-20450	HN-322	04465-28150	HN-385
04465-12140	HN-077C	04465-20470	HN-267	04465-28151	HN-385
04465-12160	HN-267	04465-20480	HN-472	04465-28170	HN-399
04465-12240	HN-077C	04465-20490	HN-322	04465-28171	HN-399
04465-12250	HN-077C	04465-20500	HN-430	04465-28180	HN-328
04465-12280	HN-134	04465-20540	HN-430	04465-28190	HN-327
04465-12470	HN-081	04465-20600	HN-360	04465-28220	HN-328
04465-12490	HN-077C	04465-21010	HN-077C	04465-28240	HN-218
04465-12510	HN-077C	04465-21020	HN-480	04465-28270	HN-218
04465-12550	HN-077C	04465-22050	HN-246	04465-28340	HN-404
04465-12580	HN-472	04465-22060	HN-246	04465-28360	HN-405
04465-12581	HN-472	04465-22090	HN-246	04465-28370	HN-404
04465-12590	HN-472	04465-22140	HN-071	04465-28380	HN-404
04465-12591	HN-472	04465-22180	HN-246	04465-28381	HN-404
04465-12592	HN-472	04465-22210	HN-071	04465-28390	HN-405
04465-13010	HN-077C	04465-22280	HN-322	04465-28400	HN-448
04465-13030	HN-430	04465-22290	HN-071	04465-28420	HN-404
04465-13040	HN-472	04465-22300	HN-434	04465-28430	HN-448
04465-13041	HN-472	04465-22311	HN-324	04465-28510	HN-480
04465-14020	HN-141	04465-24010	HN-228	04465-28520	HN-527
04465-14030	HN-141	04465-24020	HN-166	04465-28010	HN-430
04465-14081	HN-324	04465-24021	HN-231A	04465-30021	HN-052-2
04465-14100	HN-141	04465-24030	HN-141	04465-30040	HN-157-2T
04465-14120	HN-141	04465-24040	HN-228	04465-30060	HN-157-2T
04465-14150	HN-360	04465-25010	HN-212	04465-30080	HN-228
04465-14340	HN-141	04465-25020	HN-229	04465-30100	HN-157
04465-14350	HN-081	04465-25030	HN-229	04465-30120	HN-231A
04465-16020	HN-077C	04465-25040	HN-144	04465-30170	HN-157
04465-16031	HN-077C	04465-25060	HN-144	04465-30231	HN-324
04465-16070	HN-077C	04465-25070	HN-212	04465-30240	HN-322
04465-16120	HN-077C	04465-25080	HN-229	04465-30250	HN-322T
04465-17021	HN-077C	04465-26020	HN-166	04465-30271	HN-324
04465-17060	HN-275	04465-26030	HN-227	04465-30272	HN-324
04465-17070	HN-077C	04465-26051	HN-227	04465-30280	HN-442
04465-17100	HN-472	04465-26090	HN-144	04465-30300	HN-442
04465-17101	HN-472	04465-26140	HN-166	04465-30320	HN-324
04465-17140	HN-472	04465-26210	HN-209	04465-30330	HN-442
04465-1A010	HN-430	04465-26260	HN-144	04465-30340	HN-479
04465-20020	HN-077C	04465-26270	HN-209	04465-30400	HN-547
04465-20030	HN-077C	04465-26300	HN-237	04465-32021	HN-077C

TOYOTA-2 Brake Pad-Cross Reference

Genuine Parts No.	JFBK Parts No.	Genuine Parts No.	JFBK Parts No.	Genuine Parts No.	JFBK Parts No.
04465-32050	HN-281	04465-37050	HN-441	04465-52170	HN-472
04465-32080	HN-259	04465-37060	HN-441	04465-52180	HN-508
04465-32091	HN-281	04465-37070	HN-464	04465-52190	HN-518
04465-32110	HN-281	04465-37090	HN-464	04465-52210	HN-540
04465-32120	HN-260	04465-37100	HN-329	04465-52220	HN-540
04465-32170	HN-281	04465-37190	HN-464	04465-52230	HN-540
04465-32191	HN-430	04465-40010	HN-209	04465-52240	HN-518
04465-32200	HN-322	04465-42010	HN-322	04465-52260	HN-508
04465-32210	HN-472	04465-42011	HN-322	04465-52270	HN-518
04465-32220	HN-430	04465-42012	HN-322	04465-60020	HN-242
04465-32230	HN-472	04465-42060	HN-322	04465-60030	HN-219
04465-33020	HN-322	04465-42070	HN-447	04465-60110	HN-242
04465-33021	HN-322	04465-42071	HN-447	04465-60151	HN-411
04465-33050	HN-322	04465-42090	HN-322	04465-60170	HN-411
04465-33060	HN-228	04465-42110	HN-447	04465-60190	HN-411
04465-33070	HN-228	04465-42120	HN-322	04465-60220	HN-411
04465-33121	HN-401	04465-42130	HN-447	04465-60230	HN-411
04465-33130	HN-401	04465-42150	HN-530	04465-60250	HN-411
04465-33180	HN-401	04465-42160	HN-524	04465-60280	HN-541
04465-33210	HN-322	04465-43010	HN-386T	04465-65010	HN-393
04465-33240	HN-479	04465-43020	HN-402T	04465-65020	HN-480
04465-33270	HN-480	04465-43030	HN-386T	04465-65021	HN-480
04465-33280	HN-480	04465-44030	HN-322	04465-68010	HN-479
04465-33320	HN-479	04465-44050	HN-470	04465-B1010	HN-492
04465-33440	HN-521	04465-44100	HN-470	04465-B1050	HN-492
04465-33450	HN-521	04465-44140	HN-479	04465-B1150	HN-492
04465-35010	HN-209	04465-47010	HN-322	04465-B1170	HN-443
04465-35020	HN-209	04465-47030	HN-472	04465-B4010	HN-416
04465-35030	HN-219	04465-47050	HN-472	04465-B4030	HN-416
04465-35031	HN-219	04465-48010	HN-401	04465-22312-79	HN-547
04465-35040	HN-219	04465-48030	HN-457	04465-30410-79	HN-455
04465-35080	HN-387	04465-48050	HN-481	04466-05010	HN-528
04465-35120	HN-071	04465-48100	HN-497	04466-07010	HN-323
04465-35140	HN-351	04465-50020	HN-228	04466-07011	HN-323
04465-35170	HN-086	04465-50030	HN-325	04466-07020	HN-323
04465-35220	HN-227	04465-50040	HN-324	04466-12010	HN-136
04465-35240	HN-387	04465-50070	HN-370	04466-12031	HN-136
04465-35250	HN-482	04465-50130	HN-228	04466-12040	HN-136
04465-35260	HN-219	04465-50170	HN-455	04466-12070	HN-136
04465-35280	HN-387	04465-50171	HN-455	04466-12080	HN-136
04465-35290	HN-482	04465-50190	HN-455	04466-12100	HN-109
04465-35320	HN-209	04465-50230	HN-455	04466-12110	HN-136
04465-36010	HN-388	04465-50250	HN-455	04466-12130	HN-519
04465-36020	HN-329	04465-52010	HN-472	04466-14010	HN-142C
04465-36030	HN-330	04465-52011	HN-472	04466-14040	HN-361
04465-36040	HN-229	04465-52021	HN-472	04466-17030	HN-496
04465-36050	HN-099	04465-52022	HN-472	04466-17040	HN-496
04465-36080	HN-330	04465-52040	HN-471	04466-17050	HN-123
04465-36090	HN-330	04465-52041	HN-471	04466-17070	HN-123
04465-37010	HN-329	04465-52090	HN-471	04466-17080	HN-496
04465-37020	HN-441	04465-52100	HN-472	04466-17100	HN-496
04465-37030	HN-329	04465-52110	HN-472	04466-18010	HN-178
04465-37040	HN-330	04465-52120	HN-472	04466-20020	HN-321

TOYOTA-3 Brake Pad-Cross Reference

Genuine Parts No.	JFBK Parts No.	Genuine Parts No.	JFBK Parts No.	Genuine Parts No.	JFBK Parts No.
04466-20050	HN-361	04466-33130	HN-458	04491-14360	HN-324
04466-20080	HN-321	04466-33140	HN-458	04491-20251	HN-077C
04466-20090	HN-454	04466-33150	HN-321	04491-26310	HN-227
04466-21010	HN-458	04466-33160	HN-522	04491-32131	HN-281
04466-22010	HN-074	04466-33170	HN-458	04491-33110	HN-228
04466-22030	HN-142C	04466-33180	HN-522	04491-36070	HN-329
04466-22040	HN-142C	04466-37100	HN-543	04491-36080	HN-330
04466-22060	HN-323	04466-40010	HN-142C	04491-87401	HN-416
04466-22070	HN-142C	04466-40030	HN-142C	04491-97205	HN-427
04466-22090	HN-142C	04466-40040	HN-326	04491-97401	HN-427
04466-22100	HN-074	04466-42010	HN-424	04491-97402	HN-443
04466-22110	HN-142C	04466-42030	HN-424	04491-97505	HN-341
04466-22140	HN-323	04466-42040	HN-424	04491-97507	HN-341
04466-22150	HN-409	04466-42050	HN-424	04491-B1010	HN-492
04466-22160	HN-323	04466-42060	HN-522	04492-07010	HN-323
04466-22170	HN-409	04466-45010	HN-449	04492-14161	HN-361
04466-22180	HN-421	04466-48020	HN-458	04492-50040	HN-363
04466-24010	HN-363	04466-48030	HN-498		
04466-24020	HN-363	04466-48040	HN-498		
04466-26010	HN-363	04466-48060	HN-498		
04466-26020	HN-363	04466-48090	HN-498		
04466-28010	HN-274	04466-50010	HN-252		
04466-28011	HN-274	04466-50041	HN-363		
04466-28030	HN-449	04466-50050	HN-326		
04466-28050	HN-449	04466-50051	HN-326		
04466-28070	HN-449	04466-50070	HN-252		
04466-28080	HN-449	04466-50080	HN-326		
04466-28110	HN-528	04466-50090	HN-456		
04466-30010	HN-142C	04466-50091	HN-456		
04466-30020	HN-363	04466-51011	HN-421		
04466-30030	HN-363	04466-51020	HN-421		
04466-30070	HN-074	04466-52010	HN-454		
04466-30080	HN-323T	04466-52020	HN-454		
04466-30100	HN-363	04466-52030	HN-454		
04466-30122	HN-421	04466-52050	HN-454		
04466-30140	HN-363	04466-52060	HN-454		
04466-30150	HN-421	04466-52070	HN-519		
04466-30151	HN-421	04466-52090	HN-454		
04466-30161	HN-421	04466-52120	HN-519		
04466-30170	HN-421	04466-52130	HN-519		
04466-30190	HN-421	04466-53010	HN-494		
04466-30210	HN-494	04466-60010	HN-243		
04466-30230	HN-494	04466-60020	HN-243		
04466-32010	HN-321	04466-60030	HN-412		
04466-32020	HN-321	04466-60050	HN-243		
04466-32030	HN-431	04466-60060	HN-243		
04466-32040	HN-431	04466-60070	HN-412		
04466-32050	HN-321	04466-60080	HN-243		
04466-33010	HN-321	04466-60090	HN-243		
04466-33040	HN-321	04466-60120	HN-542		
04466-33050	HN-321	04466-65010	HN-394		
04466-33090	HN-458	04491-12372	HN-077C		
04466-33110	HN-321	04491-14331	HN-360		

NISSAN-1 Brake Pad-Cross Reference

Genuine Parts No.	JFBK Parts No.	Genuine Parts No.	JFBK Parts No.	Genuine Parts No.	JFBK Parts No.
41060-01A25	HN-108	41060-17V90	HN-137	41060-4A0A3	HN-426
41060-01A90	HN-108	41060-18V91	HN-137	41060-4A0A5	HN-523
41060-01B25	HN-131	41060-18V93	HN-137	41060-4L090	HN-201A
41060-01B26	HN-131	41060-19V85	HN-105	41060-4P190	HN-261
41060-01B90	HN-131	41060-1E090	HN-309	41060-50Y90	HN-226
41060-01B91	HN-131	41060-1W385	HN-531	41060-50Y93	HN-226
41060-01F85	HN-104	41060-1W387	HN-531	41060-50Y94	HN-226
41060-01F86	HN-104	41060-21T90	HN-204	41060-51E85	HN-188
41060-02J90	HN-132B	41060-21U90	HN-358	41060-51E87	HN-188
41060-02J91	HN-132B	41060-23C90	HN-137	41060-52F90	HN-367
41060-03R85	HN-104	41060-25A25	HN-108	41060-54C85	HN-268
41060-03R86	HN-104	41060-25T90	HN-204	41060-54C88	HN-268
41060-04U90	HN-220	41060-27C85	HN-149	41060-57C90	HN-199
41060-05N90	HN-137	41060-27N90	HN-137	41060-57C91	HN-199
41060-05N93	HN-137	41060-27N91	HN-320	41060-58A86	HN-367
41060-05N94	HN-137	41060-27N92	HN-137	41060-58Y85	HN-225
41060-06F86	HN-104	41060-28B85	HN-367	41060-58Y87	HN-225
41060-06F88	HN-104	41060-28B86	HN-367	41060-5L725	HN-201A
41060-09W25	HN-105	41060-28E25	HN-104	41060-5P690	HN-261
41060-09W27	HN-105	41060-28N90	HN-137	41060-5T091	HN-105
41060-09W92	HN-105	41060-28N91	HN-320	41060-5V285	HN-531
41060-0E590	HN-176	41060-2S790	HN-137	41060-60R91	HN-226
41060-0E785	HN-188	41060-32E91	HN-105	41060-60S85	HN-105
41060-0E786	HN-188	41060-32E92	HN-105	41060-60S87	HN-105
41060-0H090	HN-105	41060-32E94	HN-105	41060-60Y91	HN-375
41060-0M685	HN-268	41060-32G91	HN-137	41060-62A90	HN-108
41060-0M890	HN-356	41060-32G92	HN-137	41060-63Y90	HN-226
41060-0M893	HN-356	41060-32G94	HN-137	41060-65E90	HN-176
41060-0N685	HN-268	41060-32J90	HN-383	41060-65E91	HN-176
41060-0P691	HN-261	41060-32R90	HN-176	41060-67R85	HN-225
41060-0P693	HN-261	41060-32R91	HN-176	41060-69C85	HN-268
41060-0P694	HN-261	41060-34Y90	HN-199	41060-6A00A	HN-453
41060-0T385	HN-368	41060-35F92	HN-367	41060-6A00B	HN-437
41060-0T386	HN-368	41060-35F93	HN-367	41060-6J090	HN-176
41060-0V090	HN-201A	41060-37J90	HN-308	41060-6T390	HN-446
41060-0W785	HN-531	41060-3C490	HN-245	41060-70T85	HN-317
41060-0W786	HN-531	41060-3J190	HN-176	41060-71E90	HN-176
41060-11C85	HN-149	41060-3J191	HN-176	41060-72B25	HN-410
41060-11C86	HN-149	41060-40F90	HN-199	41060-73L91	HN-201A
41060-11P27	HN-105	41060-40F93	HN-199	41060-73L92	HN-201A
41060-11P29	HN-105	41060-40P90	HN-220	41060-73L93	HN-201A
41060-11P86	HN-105	41060-40U92	HN-201A	41060-74F90	HN-358
41060-11P91	HN-105	41060-40U93	HN-201A	41060-75A92	HN-108
41060-11P94	HN-105	41060-41B92	HN-131	41060-75F90	HN-199
41060-12C85	HN-149	41060-41B93	HN-131	41060-75T90	HN-201A
41060-12C86	HN-149	41060-41S85	HN-104	41060-76A86	HN-367
41060-13A91	HN-108	41060-41S86	HN-104	41060-76A87	HN-367
41060-13V90	HN-105	41060-41S87	HN-104	41060-77A90	HN-108
41060-13V91	HN-105	41060-45E85	HN-188	41060-78E90	HN-176
41060-15U90	HN-176	41060-47R91	HN-245	41060-78E91	HN-176
41060-17B90	HN-131	41060-48R92	HN-245	41060-78J90	HN-176
41060-17B91	HN-131	41060-4A00A	HN-523	41060-79E91	HN-245
41060-17U90	HN-309	41060-4A0A2	HN-426	41060-79E92	HN-245

NISSAN-2

Brake Pad-Cross Reference

Genuine Parts No.	JFBK Parts No.	Genuine Parts No.	JFBK Parts No.	Genuine Parts No.	JFBK Parts No.
41060-84L90	HN-176	41060-G8385	HN-149	44060-01P90	HN-377
41060-84L91	HN-176	41060-HA025	HN-332	44060-01P93	HN-377
41060-85V00	PF-0018	41060-HA026	HN-332	44060-04S27	HN-377
41060-86R86	HN-225	41060-HA027	HN-332	44060-04U85	HN-221
41060-88E90	HN-201A	41060-HA028	HN-332	44060-05J86	HN-371
41060-89TA2	HN-384	41060-HC025	HN-211	44060-05J87	HN-371
41060-89TA3	HN-288	41060-HC026	HN-211	44060-05J88	HN-371
41060-89TB4	HN-289	41060-HC027	HN-211	44060-07Y85	HN-133
41060-89TB6	HN-464	41060-HC028	HN-211	44060-0M890	HN-357
41060-89TB8	HN-489	41060-HC030	HN-211	44060-0N690	HN-224
41060-89TB9	HN-384	41060-HC031	HN-211	44060-0P690	HN-262
41060-89TC6	HN-289	41060-HC050	HN-211	44060-0P691	HN-262
41060-89TC7	HN-384	41060-HC051	HN-211	44060-0P692	HN-262
41060-89TC8	HN-464	41060-HC225	HN-211	44060-10V85	HN-200
41060-89TC9	HN-384	41060-HC226	HN-211	44060-10V87	HN-200
41060-89TD0	HN-464	41060-T6490	HN-132B	44060-10V88	HN-200
41060-8H386	HN-531	41060-T7893	HN-132B	44060-15A85	HN-133
41060-91P90	HN-343T	41060-T7894	HN-132B	44060-15A86	HN-133
41060-A1586	HN-104	41060-V0425	HN-052-2	44060-15A87	HN-133
41060-A1587	HN-104	41060-V0490	HN-052-2	44060-15A88	HN-133
41060-A1686	HN-052-2	41060-V0491	HN-052-2	44060-15A89	HN-133
41060-A1687	HN-052-2	41060-V0492	HN-052-2	44060-21P85	HN-200
41060-A1987	HN-105	41060-V4810	PF-0018	44060-31U92	HN-224
41060-AA190	HN-309	41060-V4912	HN-122	44060-32G85	HN-304
41060-AA525	HN-358	41060-V4963	HN-121	44060-32J86	HN-371
41060-AA591	HN-358	41060-V5025	HN-105	44060-35F91	HN-377
41060-AX085	HN-452	41060-V5026	HN-105	44060-35F92	HN-377
41060-C7025	HN-132B	41060-V5090	HN-105	44060-41L85	HN-200
41060-C7090	HN-132B	41060-V5091	HN-105	44060-43P85	HN-221
41060-C7890	HN-132B	41060-V5094	HN-105	44060-44B90	HN-277
41060-C7891	HN-132B	41060-V5785	HN-105	44060-45L85	HN-200
41060-C7892	HN-132B	41060-V5787	HN-105	44060-4U010	HN-467
41060-C8186	HN-132B	41060-V6787	HN-105	44060-50A85	HN-133
41060-CK025	HN-488	41060-V7090	HN-137	44060-50A87	HN-133
41060-CN000	HN-488	41060-V7092	HN-137	44060-53F92	HN-377
41060-CN085	HN-488	41060-V7094	HN-137	44060-54C90	HN-224
41060-D3085	HN-104	41060-V7685	HN-105	44060-58S85	HN-200
41060-D4725	HN-104	41060-VB290	HN-413	44060-58Y25	HN-283
41060-F2893	HN-052-2	41060-VC091	HN-413	44060-58Y85	HN-283
41060-F2894	HN-052-2	41060-VH385	HN-531	44060-60F90	HN-377
41060-F5025	HN-104	41060-VJ490	HN-137	44060-61E90	HN-130
41060-F5026	HN-104	41060-VR025	HN-105	44060-61E92	HN-130
41060-F5027	HN-104	41060-VR985	HN-105	44060-61E94	HN-130
41060-F5085	HN-104	41060-VW085	HN-475	44060-61J90	HN-224
41060-F5086	HN-104	41060-W1225	HN-104	44060-61J92	HN-224
41060-F5087	HN-104	41060-W2725	HN-104	44060-65E90	HN-130
41060-F6494	HN-105	41060-W2726	HN-104	44060-6E390	HN-224
41060-G1985	HN-306	41060-W2727	HN-104	44060-6P085	HN-262
41060-G8190	HN-176	41060-W2785	HN-104	44060-70T85	HN-270
41060-G8191	HN-176	41060-W2786	HN-104	44060-71L85	HN-270
41060-G8192	HN-176	41060-W2787	HN-104	44060-71L86	HN-270
41060-G8193	HN-176	41060-W4325	HN-104	44060-73C90	HN-224
41060-G8285	HN-149	41060-WJ185	HN-464	44060-85F90	HN-377

NISSAN-3 Brake Pad-Cross Reference

Genuine Parts No.	JFBK Parts No.	Genuine Parts No.	JFBK Parts No.	Genuine Parts No.	JFBK Parts No.
44060-85L85	HN-270	AY040-NS075	HN-176	AY040-NS820	HN-344
44060-85L86	HN-270	AY040-NS077	HN-446	AY040-NS822	HN-201A
44060-86E90	HN-130	AY040-NS078	HN-201A	AY040-NS823	HN-245
44060-A1185	HN-377	AY040-NS079	HN-444	AY040-NS824	HN-132B
44060-A1190	HN-377	AY040-NS083	HN-413	AY040-NS825	HN-367
44060-A1386	HN-060	AY040-NS084	HN-435	AY040-NS827	HN-137
44060-A1588	HN-200	AY040-NS085	HN-531	AY040-NS828	HN-105
44060-A1690	HN-130	AY040-NS086	HN-531	AY040-NS829	HN-225
44060-A1789	HN-133	AY040-NS087	HN-531	AY040-NS830	HN-176
44060-AA585	HN-221	AY040-NS090	HN-201A	AY040-NS833	HN-317
44060-AG089	HN-270	AY040-NS091	HN-444	AY040-NS834	HN-226
44060-AR085	HN-262	AY040-NS092	HN-413	AY040-NS835	HN-410
44060-D3590	HN-130	AY040-NS093	HN-531	AY040-NS836	HN-199
44060-P9125	HN-377	AY040-NS095	HN-531	AY040-NS837	HN-137
44060-V0326	HN-060	AY040-NS097	HN-309	AY040-NS838	HN-420
44060-V0327	HN-060	AY040-NS098	HN-444	AY040-NS839	HN-176
44060-V4810	PF-0019	AY040-NS100	HN-435	AY040-NS840	HN-261
44060-V4811	PF-0019	AY040-NS101	HN-504	AY040-NS841	HN-201A
44060-V4813	PF-0019	AY040-NS102	HN-504	AY040-NS842	HN-309
44060-V6786	HN-200	AY040-NS103	HN-474	AY040-NS920	HN-105
44060-VB290	HN-199	AY040-NS104	HN-531	AY040-NS921	HN-137
44060-VC090	HN-199	AY040-NS105	HN-475	AY040-NS925	HN-204
AY040-KE136	HN-437	AY040-NS106	HN-504	AY040-NS934	HN-444
AY040-KE121	HN-426	AY040-NS107	HN-220	AY060-NS003	HN-221
AY040-NS001	HN-220	AY040-NS108	HN-435	AY060-NS006	HN-283
AY040-NS003	HN-220	AY040-NS109	HN-464	AY060-NS011	HN-224
AY040-NS006	HN-188	AY040-NS110	HN-452	AY060-NS014	HN-357
AY040-NS007	HN-188	AY040-NS111	HN-474	AY060-NS015	HN-224
AY040-NS011	HN-176	AY040-NS112	HN-488	AY060-NS018	HN-224
AY040-NS014	HN-343T	AY040-NS113	HN-137	AY060-NS019	HN-224
AY040-NS017	HN-137	AY040-NS114	HN-137	AY060-NS020	HN-221
AY040-NS019	HN-131	AY040-NS115	HN-505	AY060-NS021	HN-224
AY040-NS020	HN-131	AY040-NS116	HN-488	AY060-NS022	HN-262
AY040-NS023	HN-137	AY040-NS118	HN-474	AY060-NS023	HN-422
AY040-NS024	HN-320	AY040-NS119	HN-474	AY060-NS026	HN-466
AY040-NS025	HN-220	AY040-NS120	HN-452	AY060-NS027	HN-422
AY040-NS037	HN-358	AY040-NS122	HN-444	AY060-NS028	HN-467
AY040-NS038	HN-105	AY040-NS124	HN-464	AY060-NS029	HN-262
AY040-NS040	HN-268	AY040-NS128	HN-474	AY060-NS030	HN-466
AY040-NS041	HN-201A	AY040-NS129	HN-444	AY060-NS031	HN-224
AY040-NS043	HN-531	AY040-NS130	HN-517	AY060-NS032	HN-377
AY040-NS045	HN-531	AY040-NS132	HN-546	AY060-NS033	HN-467
AY040-NS050	HN-261	AY040-NS133	HN-452	AY060-NS034	HN-262
AY040-NS054	HN-201A	AY040-NS135	HN-475	AY060-NS035	HN-422
AY040-NS056	HN-464	AY040-NS136	HN-545	AY060-NS036	HN-422
AY040-NS059	HN-531	AY040-NS138	HN-474	AY060-NS037	HN-467
AY040-NS061	HN-137	AY040-NS802	HN-108	AY060-NS038	HN-466
AY040-NS062	HN-201A	AY040-NS814	HN-137	AY060-NS039	HN-466
AY040-NS063	HN-261	AY040-NS815	HN-356	AY060-NS040	HN-466
AY040-NS064	HN-410	AY040-NS816	HN-356	AY060-NS041	HN-466
AY040-NS065	HN-317	AY040-NS817	HN-420	AY060-NS043	HN-466
AY040-NS067	HN-358	AY040-NS818	HN-201A	AY060-NS045	HN-466
AY040-NS074	HN-531	AY040-NS819	HN-410	AY060-NS801	HN-200

NISSAN-4 Brake Pad-Cross Reference

Genuine Parts No.	JFBK Parts No.	Genuine Parts No.	JFBK Parts No.	Genuine Parts No.	JFBK Parts No.
AY060-NS803	HN-224	D106M-S1825	HN-108		
AY060-NS901	HN-200	D106M-S1826	HN-226		
D1060-02J90	HN-132B	D106M-S1827	HN-367		
D1060-05N90	HN-320	D106M-S1828	HN-225		
D1060-06F86	HN-104	D106M-S2225	HN-149		
D1060-0H090	HN-105	D106M-S2525	HN-176		
D1060-0M892	HN-356	D106M-S2526	HN-245		
D1060-0M893	HN-356	D106M-S2825	HN-105		
D1060-0P690	HN-261	D106M-S2826	HN-137		
D1060-11P26	HN-105	D106M-S2885	HN-105		
D1060-11P27	HN-105	D106M-S3685	HN-132B		
D1060-11P28	HN-105	D106M-S3687	HN-204		
D1060-11P85	HN-105	D4060-01P90	HN-377		
D1060-11P86	HN-105	D4060-15A85	HN-133		
D1060-11P90	HN-105	D4060-15A86	HN-133		
D1060-28N90	HN-137	D4060-15A87	HN-133		
D1060-32E25	HN-105	D406M-N0985	HN-270		
D1060-32E91	HN-105	D406M-N0986	HN-377		
D1060-32E93	HN-105	D406M-N0987	HN-130		
D1060-37J91	HN-308	D406M-N0988	HN-130		
D1060-3C490	HN-245	D406M-N0989	HN-224		
D1060-40F90	HN-199	D406M-N1185	HN-221		
D1060-50Y90	HN-226	D406M-N1425	HN-200		
D1060-50Y93	HN-226	D406M-S2085	HN-371		
D1060-50Y94	HN-375				
D1060-57G90	HN-137				
D1060-5P690	HN-261				
D1060-6J091	HN-176				
D1060-75A90	HN-108				
D1060-79E92	HN-245				
D1060-85F90	HN-201A				
D1060-88E85	HN-201A				
D1060-88E86	HN-201A				
D1060-CN91B	HN-488				
D1060-F2894	HN-052-2				
D1060-F6494	HN-105				
D1060-G8190	HN-176				
D1060-V6790	HN-105				
D1060-W4325	HN-104				
D106M-B2885	HN-105				
D106M-N1685	HN-131				
D106M-N1885	HN-080				
D106M-N1886	HN-108				
D106M-N1887	HN-367				
D106M-N2285	HN-104				
D106M-N2286	HN-104				
D106M-N2287	HN-188				
D106M-N2288	HN-199				
D106M-N2289	HN-268				
D106M-N2585	HN-201A				
D106M-N2885	HN-105				
D106M-N2886	HN-137				
D106M-S1685	HN-131				

MITSUBISHI-1 Brake Pad-Cross Reference

Genuine Parts No.	JFBK Parts No.	Genuine Parts No.	JFBK Parts No.	Genuine Parts No.	JFBK Parts No.
MC112140	HN-349	MQ908293	HN-376	MR449854	HN-417
MC112164	HN-345	MR334950	HN-417	MR475244	HN-271
MC112191	HN-175	MR389500	HN-167	MR475453	HN-417
MC112192	HN-175	MR389503	HN-089	MR493173	HN-437
MC112193	HN-349	MR389504	HN-244	MR493985	HN-403
MC112194	HN-349	MR389505	HN-473	MR510539	HN-414
MC112201	HN-222	MR389506	HN-286	MR510544	HN-450
MC112202	HN-222	MR389509	HN-285T	MR510925	HN-272
MC837978	HN-349	MR389510	HN-285	MR527128	HN-453
MC838357	HN-346	MR389511	HN-285	MR527674	HN-469
MC838358	HN-348	MR389513	HN-115	MR569224	HN-462
MC838359	HN-347	MR389514	HN-352	MR569225	HN-462
MC838485	HN-346	MR389516	HN-352	MR569403	HN-469
MC838486	HN-348	MR389517	HN-311	MR569592	HN-403
MC838487	HN-348	MR389518	HN-379	MR955068	HN-502
MC838488	HN-349	MR389521	HN-158	MR977238	HN-403
MC838489	HN-349	MR389526	HN-172	MR977345	HN-414
MC838490	HN-349	MR389528	HN-173	4605A261	HN-469
MC838515	HN-347	MR389530	HN-158	4605A265	HN-450
MC862934	HN-349	MR389531	HN-158	4605A272	HN-453
MC862937	HN-349	MR389534	HN-271	4605A336	HN-502
MC862938	HN-349	MR389537	HN-271	4605A340	HN-426
MC862939	HN-349	MR389539	HN-271	4605A364	HN-469
MC869384	HN-346	MR389540	HN-271	4605A389	HN-243
MC869773	HN-349	MR389544	HN-233	4605A447	HN-450
MC869777	HN-349	MR389546	HN-233	4605A471	HN-414
MC869778	HN-349	MR389547	HN-369	4605A481	HN-482
MC869779	HN-349	MR389548	HN-403	4605A486	HN-469
MC886334	HN-349	MR389549	HN-233	4605A527	HN-426
MC894576	HN-346	MR389552	HN-233	4605A530	HN-469
MC894577	HN-346	MR389554	HN-084	4605A592	HN-437
MC894579	HN-346	MR389555	HN-084	4605A644	HN-415
MC894580	HN-346	MR389556	HN-084		
MC894597	HN-347	MR389557	HN-084		
MC894598	HN-347	MR389560	HN-203		
MC894601	HN-407	MR389561	HN-110		
MC894604	HN-407	MR389563	HN-312		
MK385473	HN-349	MR389564	HN-284		
MK449107	HN-514	MR389565	HN-314		
MK449108	HN-513	MR389566	HN-110		
MK449937	HN-515	MR389567	HN-373		
MK528945	HN-513	MR389568	HN-372		
MK529247	HN-515	MR389569	HN-314		
MK529355	HN-514	MR389570	HN-152		
MK529381	HN-515	MR389571	HN-280		
MN102192	HN-435	MR389572	HN-280		
MN113093	HN-453	MR389575	HN-391		
MN116151	HN-500	MR389578	HN-174		
MN116286	HN-450	MR389580	HN-174		
MN116604	HN-462	MR389581	HN-272		
MN116770	HN-314	MR389582	HN-272		
MQ908290	HN-332	MR407127	HN-419		
MQ908292	HN-332	MR407422	HN-414		

MAZDA-1
Brake Pad-Cross Reference

Genuine Parts No.	JFBK Parts No.	Genuine Parts No.	JFBK Parts No.	Genuine Parts No.	JFBK Parts No.
1A00-26-43Z	HN-266	B2YV-33-23Z	HN-230	D2Y6-33-23Z	HN-232
1A00-33-23Z	HN-408	B3YH-33-23Z	HN-507	D2Y6-33-28Z	HN-232
1A01-33-23Z	HN-118	B4Y1-26-48Z	HN-353	D2Y7-33-23ZA	HN-232
1A02-33-23Z	HN-426	B4Y1-26-49Z	HN-198	D2Y7-33-28ZA	HN-232
1A02-33-23ZA	HN-426	B571-33-23Z	HN-138	D2Y9-33-23ZA	HN-232
1A02-33-23ZB	HN-426	B5Y6-33-23ZA	HN-232	D2Y9-33-28ZA	HN-232
1A02-33-23ZC	HN-426	B5Y6-33-28ZA	HN-232	D3Y0-33-28ZA	HN-495
1A04-33-23Z	HN-439	B5Y8-33-23ZA	HN-232	D6Y1-33-28Z	HN-544
1A04-33-23ZA	HN-439	B5Y8-33-28ZB	HN-232	EOY8-26-43ZB	HN-198
1A04-33-23ZB	HN-439	B6Y3-26-43ZA	HN-353	EOY9-26-43ZA	HN-198
1A04-33-23ZC	HN-439	B6Y8-26-43ZA	HN-203	F070-33-28ZA	HN-316
1A05-33-23Z	HN-426	B6Y8-26-48Z	HN-203	F1Z4-33-23Z	HN-316
1A05-33-23ZA	HN-426	B6Y8-33-23ZA	HN-300	F1Z4-33-28Z	HN-316
1A07-33-23Z	HN-118	BCYC-33-23Z	HN-232	FB06-49-280A	HN-203
1A13-33-23Z	HN-426	BCYF-26-43ZA	HN-365	FB71-26-28ZA	HN-203
1A15-33-23Z	HN-523	BCYF-26-48Z	HN-365	FC02-33-28ZA	HN-316
1A16-33-23Z	HN-523	BCYW-33-23ZC	HN-232	FDY1-26-43ZA	HN-203
1A50-33-23Z	HN-382	BCYW-33-28ZA	HN-232	FDY1-26-48Z	HN-203
1A51-33-23Z	HN-301	BKYT-26-43Z	HN-476	FDZ3-33-28ZA	HN-316
1A52-33-23Z	HN-382	BKYT-26-43ZB	HN-476	G0YG-26-43Z	HN-195
1A60-33-280A	HN-378	BKYT-26-48Z	HN-476	G0YK-26-43ZA	HN-203
1A61-33-280B	HN-183	BKYT-26-48ZB	HN-476	G0YK-33-23ZA	HN-331
1K00-33-23ZA	HN-464	BL53-33-28Z	HN-138	G0YK-33-28Z	HN-331
1K02-33-23Z	HN-384	BL53-33-28ZA	HN-138	G1YC-33-23Z	HN-418
1K05-33-23Z	HN-491	BL78-26-48Z	HN-353	G1YC-33-23ZA	HN-418
1K09-33-23Z	HN-464	BLYM-33-23Z	HN-239	G1YC-33-28Z	HN-418
1N00-33-28ZA	HN-375	BLYM-33-28Z	HN-239	G1YC-33-28ZA	HN-418
1N01-33-28Z	HN-225	BRY4-33-23Z	HN-230	G1YC-33-28ZB	HN-418
1N03-33-28ZA	HN-225	BRY4-33-23ZA	HN-230	G1YH-33-23Z	HN-194
1N04-33-28Z	HN-356	BRY4-33-28ZA	HN-230	G1YH-33-28Z	HN-194
1N06-33-28Z	HN-356	BRY6-33-23ZA	HN-230	G1YN-33-23Z	HN-418
1N13-33-28Z	HN-435	BRY7-33-23ZA	HN-232	G1YN-33-23ZA	HN-418
1N14-33-28Z	HN-435	BWYH-26-43Z	HN-198	G1YN-33-28Z	HN-418
1N17-33-28Z	HN-435	C1Y0-33-23Z	HN-239	G1YN-33-28ZA	HN-418
1N19-33-28Z	HN-435	C1Y0-33-23ZA	HN-239	G2YS-33-23ZB	HN-526
1N21-33-28Z	HN-435	C1Y0-33-28Z	HN-239	G2YS-33-28Z	HN-526
A061-33-23ZA	HN-213	C1Y0-33-28ZA	HN-239	G225-33-28Z	HN-194
A0Z1-33-23Z	HN-182	CBY0-33-23Z	HN-239	G5Y6-26-43ZC	HN-238
B001-49-280A	HN-070	CBY0-33-28Z	HN-239	G5Y6-26-48ZA	HN-238
B092-33-28ZA	HN-138	CBY1-33-23ZC	HN-239	G5Y6-33-23ZC	HN-239
B095-33-28Z	HN-138	CBY1-33-23ZD	HN-239	G5Y6-33-28ZB	HN-239
B095-33-28ZA	HN-138	CBY1-33-23ZF	HN-239	G718-33-28ZA	HN-194
BOY1-33-23ZA	HN-300	CBY1-33-23ZG	HN-239	G7Y6-33-23Z	HN-239
BOY1-33-28Z	HN-300	CBY1-33-28ZC	HN-239	G7Y6-33-28ZA	HN-239
BOYA-26-43ZA	HN-365	CBY1-33-28ZD	HN-239	GAYE-26-43ZB	HN-238
BOYW-33-23ZC	HN-230	CBY1-33-28ZF	HN-239	GAYE-26-43ZC	HN-238
BOYW-33-28ZA	HN-230	CBY1-33-28ZG	HN-239	GAYR-33-23ZE	HN-239
B100-33-28Z	HN-138	D001-33-28Z	HN-165	GCYD-33-23ZC	HN-239
B100-33-28ZA	HN-138	D040-33-28Z	HN-165	GCYD-33-23ZD	HN-239
B107-26-48Z	HN-353	D1Y4-33-23Z	HN-232	GCYD-33-23ZE	HN-239
B2YB-33-23Z	HN-232	D1Y4-33-28Z	HN-232	GCYD-33-28ZB	HN-239
B2YD-33-23Z	HN-425	D1Y5-33-23ZA	HN-232	GCYD-33-28ZC	HN-239
B2YD-33-28Z	HN-425	D1Y5-33-28ZA	HN-232	GCYD-33-28ZD	HN-239

MAZDA-2 Brake Pad-Cross Reference

Genuine Parts No.	JFBK Parts No.	Genuine Parts No.	JFBK Parts No.	Genuine Parts No.	JFBK Parts No.
GCYD-33-28ZE	HN-239	LDY7-33-23Z	HN-459	TAY2-26-48Z	HN-335
GEYC-26-43Z	HN-203	LDY7-33-28Z	HN-459	UOY9-33-23ZA	HN-334
GEYC-26-43ZA	HN-203	NOY1-33-23Z	HN-253	UOY9-33-28Z	HN-334
GEYC-26-48Z	HN-203	NOY1-33-23ZA	HN-253	UBY2-33-28Z	HN-297
GEYC-26-48ZA	HN-203	NOY3-33-23Z	HN-364	UBZ2-33-28Z	HN-297
GHYD-33-28ZA	HN-239	NOY3-33-28Z	HN-364	W2Y5-33-23Z	HN-392
GJ25-26-48ZA	HN-195	NOY6-26-48Z	HN-365	W5Y0-33-23Z	HN-464
GJ87-26-43Z	HN-195	NOY6-26-48ZA	HN-365	W5Y0-33-28Z	HN-464
GJ87-26-48ZA	HN-195	NOY7-26-48ZB	HN-487		
GJYA-26-43Z	HN-203	NOY7-26-48ZC	HN-487		
GJYA-26-48Z	HN-203	NOY7-33-28Z	HN-486		
GJYA-33-23ZC	HN-483	NOY8-26-43Z	HN-365		
GJYA-33-28ZC	HN-483	NOY8-26-43ZA	HN-365		
GJYB-26-43Z	HN-203	NOY9-26-43ZB	HN-487		
GJYB-26-48Z	HN-203	NOY9-26-43ZC	HN-487		
GJYB-33-23ZC	HN-483	NOY9-33-23Z	HN-486		
GJYB-33-28ZC	HN-483	NAY0-26-43ZA	HN-198		
GJYE-33-23ZF	HN-526	NAY0-33-23ZB	HN-253		
GJYE-33-28ZF	HN-526	NAY0-33-23ZC	HN-253		
GN51-33-23Z	HN-194	NAY1-26-43Z	HN-198		
GN51-33-28Z	HN-194	NAY5-26-43ZA	HN-365		
GN60-33-23Z	HN-194	NAY5-26-43ZB	HN-365		
GN60-33-28Z	HN-194	NAY5-26-48Z	HN-365		
H266-26-48ZA	HN-168	NAY5-33-23ZA	HN-364		
H330-33-28ZA	HN-386T	NAY5-33-23ZB	HN-364		
H3Y0-33-28Z	HN-294	NAY5-33-28Z	HN-364		
H3Y1-33-23ZA	HN-294	NAY5-33-28ZA	HN-364		
H3Y1-33-28Z	HN-294	P1X0-26-43Z	HN-130		
H4Y0-26-43Z	HN-290	S083-49-280A	HN-211		
H4Y0-26-48Z	HN-290	S0YN-26-43Z	HN-290		
H722-33-23ZA	HN-386T	S0YN-26-48Z	HN-290		
H722-33-28ZA	HN-386T	S2YA-33-23Z	HN-211		
HE21-33-28ZB	HN-386T	S2YA-33-28Z	HN-211		
HF39-26-48ZA	HN-168	S2YA-33-28ZA	HN-211		
JOY1-26-43ZB	HN-290	S4YK-33-23Z	HN-376		
JOY1-26-48Z	HN-290	S4YK-33-23ZA	HN-376		
JOY1-33-23ZA	HN-300	S4YP-33-23Z	HN-332		
LOZ1-33-23ZA	HN-376	S4YP-33-23ZA	HN-332		
LOZ1-33-23ZB	HN-376	S4YP-33-28Z	HN-332		
LOZ1-33-28ZA	HN-376	S4YP-33-28ZA	HN-332		
LOZ1-33-28ZB	HN-376	S660-49-230	HN-211		
LAY1-33-28ZD	HN-303	S660-49-230A	HN-211		
LAY1-33-28ZE	HN-303	S660-49-280	HN-211		
LAY3-33-28Z	HN-332	S660-49-280A	HN-211		
LBYO-26-43Z	HN-290	S661-49-230	HN-211		
LBZ2-33-23Z	HN-376	SE96-33-28Z	HN-211		
LBZ2-33-28Z	HN-376	TOY0-26-43Z	HN-335		
LBZ2-33-28ZA	HN-376	TOY0-26-48Z	HN-335		
LCY2-33-23Z	HN-459	TOY0-33-23Z	HN-334		
LCY2-33-23ZA	HN-459	TOY0-33-28Z	HN-334		
LCY2-33-23ZB	HN-459	TA01-33-23Z	HN-334		
LCY2-33-28Z	HN-459	TA01-33-28Z	HN-334		
LCY2-33-28ZA	HN-459	TAY2-26-43Z	HN-335		

HONDA-1

Brake Pad-Cross Reference

Genuine Parts No.	JFBK Parts No.	Genuine Parts No.	JFBK Parts No.	Genuine Parts No.	JFBK Parts No.
06430-S0A-J00	HN-397	43022-S04-030	HN-266	43022-SV4-G00	HN-397
06430-S0K-J01	HN-255	43022-S2A-000	HN-397	43022-SV4-G02	HN-397
06430-S2A-000	HN-397	43022-S3N-000	HN-255	43022-SV4-G20	HN-397
06430-S2X-J00	HN-255	43022-S5A-J00	HN-397	43022-SV4-G21	HN-397
06430-S3N-J00	HN-255	43022-S7S-010	HN-255	43022-SV4-G22	HN-397
06430-S5A-J00	HN-397	43022-SA5-506	HN-076	43022-SX0-A51	HN-255
06430-S6D-000	HN-397	43022-SA5-950	HN-076	43022-SX0-A52	HN-255
06430-S7A-J00	HN-255	43022-SA6-505	HN-076	43022-SY8-A00	HN-397
06430-S7S-000	HN-255	43022-SA6-980	HN-076	43022-SY8-A01	HN-397
06430-SED-000	HN-255	43022-SAA-J50	HN-266	43022-SYP-000	HN-506
06430-SED-E50	HN-255	43022-SD2-930	HN-145	43022-SZ3-A01	HN-255
06430-SFE-J00	HN-506	43022-SE0-525	HN-145	45022-679-000	HN-146
06450-S0A-J00	HN-254	43022-SE0-930	HN-145	45022-679-030	HN-146
06450-S0A-J10	HN-423	43022-SE0-931	HN-145	45022-S04-000	HN-510
06450-S0K-J01	HN-445	43022-SE7-930	HN-145	45022-S04-010	HN-510
06450-S0K-J02	HN-445	43022-SED-000	HN-255	45022-S04-020	HN-510
06450-S0K-J11	HN-254	43022-SED-E50	HN-255	45022-S04-910	HN-263
06450-S2G-000	HN-510	43022-SF1-000	HN-266	45022-S04-911	HN-263
06450-S2G-J01	HN-510	43022-SF1-010	HN-266	45022-S04-912	HN-263
06450-S2H-J00	HN-254	43022-SF1-315	HN-266	45022-S04-J00	HN-510
06450-S2K-J00	HN-336	43022-SFE-000	HN-506	45022-S04-J01	HN-510
06450-S2R-J01	HN-436	43022-SG0-000	HN-397	45022-S04-J02	HN-510
06450-S3A-J00	HN-336	43022-SG0-010	HN-397	45022-S04-V00	HN-264
06450-S3N-J00	HN-445	43022-SG0-020	HN-397	45022-S04-V01	HN-264
06450-S3Y-A10	HN-263	43022-SH3-931	HN-266	45022-S04-V02	HN-264
06450-S5A-010	HN-510	43022-SH3-932	HN-266	45022-S07-010	HN-510
06450-S5A-J00	HN-264	43022-SH3-J00	HN-266	45022-S07-020	HN-510
06450-S5B-J00	HN-264	43022-SJF-000	HN-255	45022-S07-030	HN-510
06450-S5D-A01	HN-484	43022-SK7-000	HN-266	45022-S0A-940	HN-423
06450-S6M-A00	HN-423	43022-SL5-000	HN-397	45022-S0A-942	HN-423
06450-S7A-J00	HN-264	43022-SL5-525	HN-397	45022-S0A-J20	HN-445
06450-S7A-N00	HN-465	43022-SM4-525	HN-397	45022-S0K-A11	HN-445
06450-S7H-000	HN-510	43022-SM4-950	HN-397	45022-S10-000	HN-484
06450-S7S-000	HN-254	43022-SM4-G00	HN-397	45022-S10-010	HN-484
06450-S87-A00	HN-254	43022-SP0-000	HN-255	45022-S10-020	HN-484
06450-S9A-000	HN-484	43022-SP0-010	HN-255	45022-S10-A01	HN-254
06450-S9A-A00	HN-485	43022-SP0-020	HN-255	45022-S10-A02	HN-254
06450-SAA-900	HN-510	43022-SP0-305	HN-255	45022-S10-G01	HN-254
06450-SAA-901	HN-510	43022-SR2-030	HN-266	45022-S10-G02	HN-254
06450-SDD-A00	HN-465	43022-SR3-000	HN-266	45022-S2G-000	HN-510
06450-SDD-A10	HN-509	43022-SR3-010	HN-266	45022-S2K-000	HN-336
06450-SEA-J00	HN-445	43022-SR3-020	HN-266	45022-S2R-000	HN-436
06450-SEA-J01	HN-445	43022-SR3-030	HN-266	45022-S30-A00	HN-254
06450-SEA-J10	HN-445	43022-SS1-000	HN-266	45022-S30-A01	HN-254
06450-SEL-T00	HN-510	43022-SS1-020	HN-266	45022-S30-A02	HN-254
06450-SEL-T01	HN-510	43022-SV4-000	HN-397	45022-S30-J00	HN-293
06450-SFA-000	HN-336	43022-SV4-010	HN-397	45022-S30-J01	HN-293
06450-SFE-J10	HN-509	43022-SV4-030	HN-397	45022-S30-J02	HN-293
06450-SFE-J20	HN-445	43022-SV4-A00	HN-397	45022-S3A-000	HN-336
06450-SJK-010	HN-531	43022-SV4-A02	HN-397	45022-S3N-000	HN-445
06450-SNB-000	HN-465	43022-SV4-A20	HN-397	45022-S3V-A10	HN-531
43022-S04-010	HN-266	43022-SV4-A21	HN-397	45022-S3V-A11	HN-531
43022-S04-020	HN-266	43022-SV4-A22	HN-397	45022-S3Y-A10	HN-263

HONDA-2

Brake Pad-Cross Reference

Genuine Parts No.	JFBK Parts No.	Genuine Parts No.	JFBK Parts No.	Genuine Parts No.	JFBK Parts No.
45022-S47-000	HN-254	45022-SE0-325	HN-127	45022-SJF-J00	HN-465
45022-S47-010	HN-254	45022-SE0-509	HN-191	45022-SJK-020	HN-531
45022-S47-020	HN-254	45022-SE0-527	HN-127	45022-SJK-030	HN-531
45022-S50-000	HN-263	45022-SE0-911	HN-127	45022-SK7-010	HN-162
45022-S50-J50	HN-263	45022-SE0-932	HN-127	45022-SK7-506	HN-162
45022-S5A-010	HN-510	45022-SE1-911	HN-127	45022-SK7-526	HN-162
45022-S5A-J00	HN-264	45022-SEA-J00	HN-445	45022-SL0-030	HN-254
45022-S5B-J00	HN-264	45022-SEA-J01	HN-445	45022-SL0-G00	HN-254
45022-S5D-H00	HN-484	45022-SEA-J11	HN-445	45022-SL0-G02	HN-254
45022-S6M-A00	HN-423	45022-SEL-T01	HN-510	45022-SL0-J02	HN-254
45022-S70-000	HN-254	45022-SEL-T02	HN-510	45022-SL0-N10	HN-254
45022-S70-010	HN-254	45022-SEN-H00	HN-510	45022-SL5-000	HN-293
45022-S70-020	HN-254	45022-SF1-000	HN-191	45022-SL5-010	HN-293
45022-S7A-000	HN-264	45022-SF1-010	HN-191	45022-SL5-020	HN-293
45022-S7A-N00	HN-465	45022-SF1-020	HN-191	45022-SM2-010	HN-223
45022-S7H-000	HN-510	45022-SF1-305	HN-191	45022-SM2-030	HN-223
45022-S87-A01	HN-254	45022-SF1-525	HN-191	45022-SM2-525	HN-223
45022-S9A-000	HN-484	45022-SF1-526	HN-191	45022-SM4-A00	HN-374
45022-S9A-A01	HN-485	45022-SF4-000	HN-278	45022-SM4-A01	HN-374
45022-S9A-E00	HN-485	45022-SF4-010	HN-278	45022-SM5-525	HN-254
45022-SA5-000	HN-090	45022-SF4-020	HN-278	45022-SM5-A00	HN-254
45022-SA5-010	HN-090	45022-SF4-060	HN-278	45022-SNB-000	HN-465
45022-SA5-020	HN-090	45022-SF4-J20	HN-090	45022-SP0-010	HN-254
45022-SA6-673	HN-190	45022-SF4-J21	HN-090	45022-SP0-526	HN-254
45022-SA7-951	HN-090	45022-SF4-J23	HN-090	45022-SP0-A00	HN-254
45022-SAA-000	HN-263	45022-SF9-305	HN-162	45022-SR3-000	HN-265
45022-SAA-900	HN-510	45022-SF9-525	HN-162	45022-SR3-507	HN-162
45022-SAA-901	HN-510	45022-SFA-000	HN-336	45022-SR3-516	HN-263
45022-SB2-526	HN-090	45022-SFE-J10	HN-509	45022-SR3-910	HN-263
45022-SB2-930	HN-090	45022-SFE-J20	HN-445	45022-SR3-920	HN-263
45022-SB2-980	HN-190	45022-SG0-010	HN-162	45022-SR3-N31	HN-162
45022-SB6-000	HN-090	45022-SG0-020	HN-162	45022-SR3-V00	HN-264
45022-SC2-000	HN-278	45022-SG0-305	HN-162	45022-SR3-V01	HN-264
45022-SC2-010	HN-278	45022-SG0-315	HN-162	45022-SR3-V02	HN-264
45022-SC2-050	HN-278	45022-SG0-325	HN-162	45022-SR3-V03	HN-264
45022-SCC-000	HN-264	45022-SG0-335	HN-162	45022-SR7-000	HN-510
45022-SD2-527	HN-090	45022-SG0-527	HN-162	45022-SR7-010	HN-510
45022-SD2-J00	HN-090	45022-SG0-J00	HN-162	45022-SR8-A00	HN-190
45022-SD2-J01	HN-090	45022-SH3-000	HN-090	45022-SR8-A01	HN-190
45022-SD2-J02	HN-090	45022-SH3-010	HN-090	45022-SS0-000	HN-293
45022-SD4-010	HN-162	45022-SH3-317	HN-191	45022-SS0-525	HN-293
45022-SD4-020	HN-162	45022-SH3-930	HN-191	45022-SS0-A00	HN-254
45022-SD4-528	HN-162	45022-SH3-934	HN-191	45022-SS0-A02	HN-254
45022-SD4-A11	HN-162	45022-SH3-G33	HN-191	45022-SS0-G00	HN-254
45022-SD4-A12	HN-162	45022-SJ6-000	HN-278	45022-SS0-G02	HN-254
45022-SD5-000	HN-278	45022-SJ6-010	HN-278	45022-ST5-000	HN-336
45022-SD5-010	HN-278	45022-SJ6-020	HN-278	45022-ST5-010	HN-336
45022-SD5-020	HN-278	45022-SJ6-030	HN-278	45022-ST5-020	HN-336
45022-SD5-040	HN-278	45022-SJ6-050	HN-278	45022-ST7-000	HN-337
45022-SD5-060	HN-278	45022-SJ6-325	HN-278	45022-ST7-010	HN-337
45022-SDD-A00	HN-465	45022-SJ6-J00	HN-278	45022-ST7-020	HN-337
45022-SDD-A10	HN-509	45022-SJ6-J01	HN-278	45022-ST7-406	HN-337
45022-SE0-010	HN-191	45022-SJ6-J02	HN-278	45022-ST7-J00	HN-510

ISUZU-1

Brake Pad-Cross Reference

Genuine Parts No.	JFBK Parts No.	Genuine Parts No.	JFBK Parts No.	Genuine Parts No.	JFBK Parts No.
5-86000975	HN-397	8-94137937	HN-083	8-97365911	HN-464
5-86001057	HN-223	8-94154011	HN-150	8-97368980	HN-384
5-86005148	HN-266	8-94169620	HN-083	8-97377522	HN-464
5-86005149	HN-266	8-94242494	HN-083	8-97378446	HN-491
5-86005260	HN-264	8-94246997	HN-150	8-97378351	HN-543
5-86005261	HN-264	8-94314192	HN-150	8-98091271	HN-543
5-86005262	HN-510	8-94337741	HN-083	04465-25020	HN-229
5-86005263	HN-510	8-94337743	HN-083		
5-86005264	HN-510	8-94362154	HN-197		
5-86009163	HN-266	8-94362813	HN-296		
5-86009207	HN-264	8-94418110	HN-150		
5-86009208	HN-510	8-94442686	HN-140		
5-86009209	HN-510	8-94446499	HN-150		
5-86011847	HN-397	8-94461155	HN-196		
5-86011848	HN-254	8-94470482	HN-140		
5-86011849	HN-423	8-94470599	HN-083		
5-86012654	HN-423	8-94475658	HN-150		
5-86014123	HN-264	8-94479583	HN-288		
5-86014124	HN-510	8-94483222	HN-197		
5-86014125	HN-510	8-94483223	HN-197		
5-86014313	HN-397	8-97011892	HN-257		
5-86014394	HN-223	8-97029980	HN-289		
5-86014813	HN-397	8-97035257	HN-258		
5-86014833	HN-423	8-97035266	HN-299		
5-86014834	HN-264	8-97039269	HN-299		
5-86014835	HN-510	8-97041540	HN-197		
5-86014836	HN-254	8-97049429	HN-196		
5-86015191	HN-510	8-97066610	HN-197		
5-86015195	HN-397	8-97066611	HN-197		
5-86017798	HN-266	8-97078409	HN-384		
5-86019520	HN-266	8-97078457	HN-083		
5-86019530	HN-223	8-97080398	HN-288		
5-86106234	HN-320	8-97081668	HN-289		
5-86116483	HN-320	8-97082920	HN-289		
5-86116485	HN-105	8-97094710	HN-288		
5-86116486	HN-446	8-97113888	HN-258		
5-86122883	HN-531	8-97168633	HN-464		
5-86122884	HN-531	8-97168634	HN-491		
5-86122917	HN-137	8-97203209	HN-489		
5-86122918	HN-137	8-97206862	HN-196		
5-86122919	HN-531	8-97206864	HN-258		
5-86122926	HN-446	8-97206865	HN-196		
5-86122927	HN-105	8-97206868	HN-258		
5-86122928	HN-137	8-97206869	HN-258		
5-86122929	HN-204	8-97206870	HN-299		
5-86129072	HN-475	8-97206872	HN-299		
5-86133648	HN-137	8-97206873	HN-299		
5-86134702	HN-137	8-97224872	HN-140		
5-86137366	HN-531	8-97224873	HN-287		
8-94124625	HN-150	8-97226101	HN-289		
8-94128528	HN-287	8-97226103	HN-384		
8-94133685	HN-140	8-97318894	HN-384		
8-94136711	HN-150	8-97329266	HN-464		

DAIHATSU-1 Brake Pad-Cross Reference

Genuine Parts No.	JFBK Parts No.	Genuine Parts No.	JFBK Parts No.	Genuine Parts No.	JFBK Parts No.
04465-28340	HN-404	04491-87207-000	HN-451	04491-97502-000	HN-438
04465-28360	HN-405	04491-87209-000	HN-451	04491-97503-000	HN-341
04465-28370	HN-404	04491-87210-000	HN-295	04491-97505-000	HN-341
04465-28380	HN-404	04491-87212-000	HN-114	04491-97506-000	HN-512
04465-28390	HN-405	04491-87213-000	HN-451	04491-B1010-000	HN-492
04465-33021	HN-322	04491-87215-000	HN-295	04491-B5010-000	HN-512
04465-33180	HN-401	04491-87216-000	HN-451	04492-87101-000	HN-198
04465-33240	HN-479	04491-87218-000	HN-451	04492-87102-000	HN-198
04465-36010	HN-388	04491-87219-000	HN-295	04492-87201-000	HN-353
04465-36030	HN-330	04491-87222-000	HN-114	04492-87202-000	HN-353
04465-37010	HN-329	04491-87223-000	HN-114	04492-87705-000	HN-353
04465-37020	HN-441	04491-87226-000	HN-295	04492-87706-000	HN-353
04465-37030	HN-329	04491-87227-000	HN-114	04492-87707-000	HN-353
04465-37040	HN-330	04491-87228-000	HN-451		
04465-37060	HN-441	04491-87233-000	HN-114		
04465-B1020	HN-443	04491-87401-000	HN-416		
04465-B1050	HN-492	04491-87501-000	HN-114		
04465-B1170	HN-443	04491-87503-000	HN-114		
04465-B2010	HN-428	04491-87506-000	HN-355		
04465-B2020	HN-492	04491-87507-000	HN-341		
04465-B2030	HN-428	04491-87509-000	HN-341		
04465-B2090	HN-492	04491-87511-000	HN-114		
04465-B2100	HN-428	04491-87514-000	HN-341		
04465-B4010	HN-416	04491-87611-000	HN-291		
04465-B4020	HN-416	04491-87613-000	HN-291		
04465-B4030	HN-416	04491-87617-000	HN-291		
04465-B5020	HN-512	04491-87704-000	HN-187		
04465-B5050	HN-512	04491-87705-000	HN-186		
04466-32030	HN-431	04491-87706-000	HN-214		
04466-33050	HN-321	04491-87709-000	HN-186		
04466-33090	HN-458	04491-87710-000	HN-214		
04466-33140	HN-458	04491-87713-000	HN-187		
04466-33150	HN-321	04491-87719-000	HN-187		
04466-33170	HN-458	04491-87720-000	HN-186		
04491-28020-000	HN-216	04491-87723-000	HN-186		
04491-28030-000	HN-216	04491-87724-000	HN-400		
04491-28070-000	HN-216	04491-87725-000	HN-400		
04491-28071-000	HN-216	04491-87727-000	HN-400		
04491-28091-000	HN-216	04491-87728-000	HN-340		
04491-28260-000	HN-216	04491-87729-000	HN-216		
04491-28290-000	HN-328	04491-97201-000	HN-427		
04491-28330-000	HN-328	04491-97202-000	HN-429		
04491-28370-000	HN-328	04491-97203-000	HN-428		
04491-28380-000	HN-327	04491-97205-000	HN-427		
04491-87103-000	HN-214	04491-97206-000	HN-428		
04491-87104-000	HN-214	04491-97207-000	HN-443		
04491-87105-000	HN-214	04491-97209-000	HN-428		
04491-87109-000	HN-214	04491-97210-000	HN-492		
04491-87110-000	HN-214	04491-97216-000	HN-443		
04491-87113-000	HN-214	04491-97218-000	HN-428		
04491-87203-000	HN-114	04491-97401-000	HN-427		
04491-87204-000	HN-451	04491-97402-000	HN-443		
04491-87205-000	HN-451	04491-97501-000	HN-429		

SUBARU-1 Brake Pad-Cross Reference

Genuine Parts No.	JFBK Parts No.	Genuine Parts No.	JFBK Parts No.	Genuine Parts No.	JFBK Parts No.
25191GA720	HN-153	26296AE140	HN-390	26696FE070	HN-221
25191GA801	—	26296AE150	HN-493	26696KE000	HN-277
25191GA840	HN-153	26296AE160	HN-460	725191220	HN-080
25193GA130	HN-153	26296AE210	HN-390	725191221	HN-080
26290KA060	HN-181	26296AG000	HN-499	725191360	HN-080
26290KA061	HN-181	26296AG030	HN-499	725191631	HN-080
26290KA110	HN-181	26296AG050	HN-499	725191990	HN-080
26290KA120	HN-181	26296FA000	HN-248	725193040	HN-305
26290KA150	HN-181	26296FA001	HN-248	725193041	HN-305
26290KC000	HN-315	26296FA020	HN-248		
26290KC020	HN-315	26296FA021	HN-248		
26290TA000	HN-251	26296FA022	HN-248		
26290TA070	HN-251	26296FA040	HN-247		
26290TA071	HN-251	26296FA041	HN-247		
26290TA090	HN-251	26296FA100	HN-463		
26296AA000	HN-248	26296FA102	HN-463		
26296AA020	HN-248	26296FA170	HN-463		
26296AA040	HN-247	26296FE000	HN-460		
26296AA041	HN-247	26296FE020	HN-460		
26296AA060	HN-249	26296FE070	HN-463		
26296AA061	HN-249	26296FE080	HN-460		
26296AA062	HN-249	26296FE081	HN-460		
26296AA080	HN-249	26296FE090	HN-463		
26296AA081	HN-249	26296KE000	HN-433		
26296AA082	HN-249	26296KE010	HN-433		
26296AA100	HN-248	26296KE020	HN-433		
26296AA101	HN-248	26296KG000	HN-426		
26296AA120	HN-248	26296PA020	HN-137		
26296AA121	HN-248	26296PA060	HN-249		
26296AA141	HN-248	26296SA000	HN-460		
26296AA142	HN-248	26296SA020	HN-460		
26296AA143	HN-248	26296TC020	HN-477		
26296AA161	HN-248	26296TC030	HN-477		
26296AA162	HN-248	26296TC040	HN-477		
26296AA163	HN-248	26296TC050	HN-477		
26296AA181	HN-247	26296TC060	HN-263		
26296AA182	HN-247	26296TC070	HN-525		
26296AA183	HN-247	26296TC080	HN-525		
26296AC020	HN-398	26296TC090	HN-525		
26296AC021	HN-398	26696AE000	HN-415		
26296AC040	HN-390	26696AE020	HN-415		
26296AC041	HN-390	26696AE040	HN-415		
26296AC050	HN-390	26696AE080	HN-415		
26296AC060	HN-390	26696AG000	HN-501		
26296AC070	HN-390	26696AG010	HN-501		
26296AE000	HN-398	26696AG020	HN-415		
26296AE001	HN-398	26696AG030	HN-501		
26296AE002	HN-398	26696FA000	HN-221		
26296AE020	HN-390	26696FA010	HN-415		
26296AE080	HN-390	26696FC000	HN-415		
26296AE081	HN-390	26696FC001	HN-415		
26296AE100	HN-390	26696FC002	HN-415		
26296AE120	HN-463	26696FE060	HN-221		

SUZUKI-1 Brake Pad-Cross Reference

Genuine Parts No.	JFBK Parts No.	Genuine Parts No.	JFBK Parts No.	Genuine Parts No.	JFBK Parts No.
55200-50841	HN-125	55810-60FA1	HN-378		
55200-50842	HN-125	55810-60FA3	HN-378		
55200-50860	HN-182	55810-60J10	HN-443		
55200-50FA0	HN-408	55810-61F01	HN-213		
55200-56851	HN-124	55810-61F02	HN-213		
55200-56870	HN-301	55810-63J00	HN-529		
55200-56871	HN-301	55810-68H00	HN-523		
55200-60A41	HN-298	55810-72J00	HN-523		
55200-62840	HN-169	55810-72J10	HN-523		
55200-62851	HN-208	55810-74G00	HN-426		
55200-62852	HN-208	55810-74G03	HN-426		
55200-62860	HN-367	55810-75F10	HN-406		
55200-63810	HN-298	55810-75F12	HN-406		
55200-63811	HN-298	55810-75F32	HN-406		
55200-65D00	HN-301	55810-76A01	HN-443		
55200-65D01	HN-301	55810-76A02	HN-443		
55200-65D10	HN-382	55810-76A11	HN-443		
55200-65D11	HN-382	55810-76G01	HN-426		
55200-65D21	HN-301	55810-76G02	HN-426		
55200-65D31	HN-382	55810-76G03	HN-426		
55200-65D50	HN-382	55810-78A01	HN-439		
55200-70812	HN-118	55810-78A02	HN-439		
55200-70AA0	HN-118	55810-78A03	HN-439		
55200-77E00	HN-382	55810-80G01	HN-443		
55200-81A10	HN-118	55810-80G02	HN-443		
55200-81A31	HN-118	55810-80G04	HN-443		
55200-82860	HN-117	55810-80G12	HN-443		
55200-86810	HN-169	55810-80G13	HN-443		
55200-86830	HN-169				
55210-50Z00	HN-517				
55210-70B70	HN-182				
55210-84500	HN-124				
55300-86810	HN-169				
55800-60G00	HN-208				
55800-60G01	HN-208				
55800-61G60	HN-381				
55800-61G73	HN-381				
55800-61G74	HN-381				
55800-62G01	HN-198				
55800-64820	HN-205				
55800-69D00	HN-130				
55800-78G00	HN-266				
55800-80J00	HN-397				
55800-80J01	HN-397				
55810-50E10	HN-339				
55810-50Z01	HN-466				
55810-54G00	HN-461				
55810-54G11	HN-461				
55810-54G30	HN-461				
55810-54G40	HN-461				
55810-58J00	HN-426				
55810-60F02	HN-183				
55810-60F03	HN-183				

